

EVALUATION KIT
AVAILABLE

MAXIM

Broadband, Two-Output, Low-Noise Amplifier for TV Tuner Applications

General Description

The MAX2130 broadband, low-distortion, low-noise, two-output amplifier performs preamp, loop-out, and buffer functions in TV tuner applications. The device integrates functions typically achieved with discrete components into the space-saving 8-pin μ MAX-EP package. The MAX2130 provides a gain of +15dB with a noise figure less than 3.2dB over the 44MHz to 878MHz frequency range. The MAX2130 features an externally adjustable bias control, set with a single resistor, that allows the user to meet minimum linearity requirements while reducing current consumption. The device operates from a +5V single supply and only requires 93mA of supply current when nominally biased.

Applications

DVB-T Digital Broadcast Receivers
Digital/Terrestrial TV Tuners
Set-Top Boxes
Cable Modems
Analog TV Tuners

Pin Configuration appears at end of data sheet.

Features

- ◆ +5V Single-Supply Operation
- ◆ 44MHz to 878MHz Operating Frequency Range
- ◆ Guaranteed 7.4dB (min) Input Return Loss Over Frequency Range
- ◆ LNA Performance at $I_{CC} = 93\text{mA}$ ($R_{BIAS} = 15\text{k}\Omega$)
 - 15dB Gain
 - 2.8dB Noise Figure
 - +17.5dBm Input IP3
 - +27dBm Input IP2
 - +2.7dBm Input 1dB Compression Point
- ◆ Loop-Out Amplifier Performance at $I_{CC} = 93\text{mA}$ ($R_{BIAS} = 15\text{k}\Omega$)
 - 8.7dB Gain
 - 4.2dB Noise Figure
 - +17dBm Input IP3
 - +29dBm Input IP2
 - 0.5dBm Input 1dB Compression Point
- ◆ Programmable Linearity vs. Supply Current

Ordering Information

PART	TEMP RANGE	PIN-PACKAGE
MAX2130EUA	-40°C to +85°C	8 μ MAX-EP*

*Exposed paddle

Typical Operating Circuit

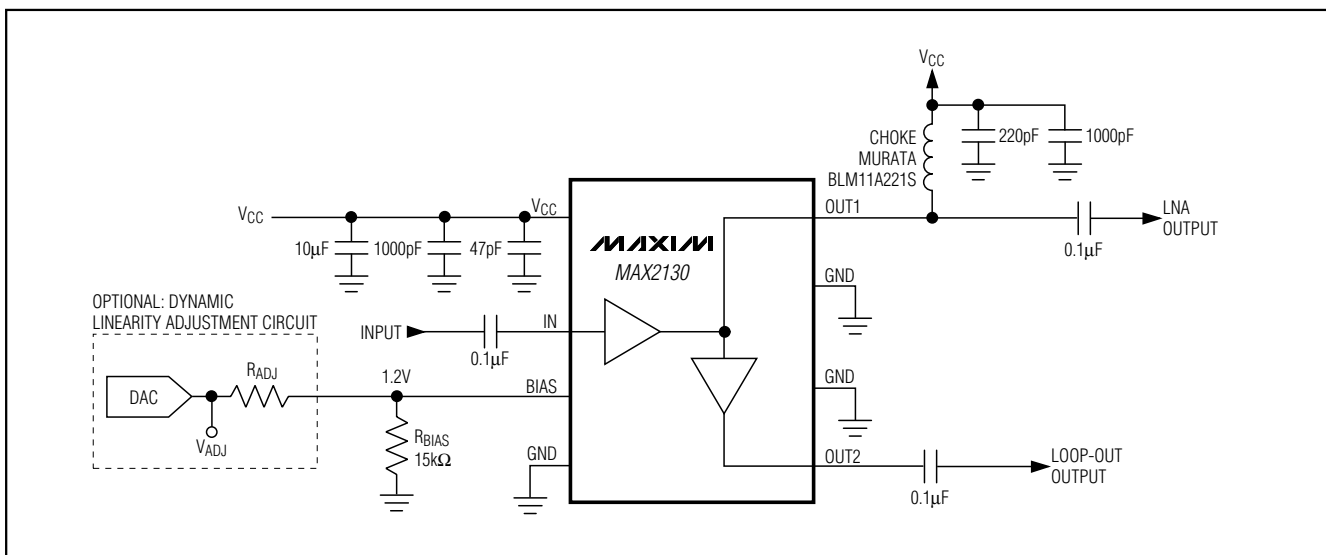

MAXIM

Maxim Integrated Products 1

For pricing, delivery, and ordering information, please contact Maxim/Dallas Direct! at 1-888-629-4642, or visit Maxim's website at www.maxim-ic.com.

MAX2130

Broadband, Two-Output, Low-Noise Amplifier for TV Tuner Applications

ABSOLUTE MAXIMUM RATINGS

V_{CC} to GND-0.3V to +6V
 BIAS, OUT2 to GND-0.3 to (V_{CC} + 0.3V)
 IN Input Power+15dBm
 OUT1 to GND-0.3V to +6V
 OUT2 Short-Circuit DurationContinuous
 Continuous Power Dissipation (T_A = +70°C)
 8-Pin μ MAX-EP (derate 15.4mW/°C above +70°C)1.2W

Operating Temperature Range-40°C to +85°C
 Junction Temperature+150°C
 Storage Temperature Range-65°C to +150°C
 Lead Temperature (soldering, 10s)+300°C

Stresses beyond those listed under "Absolute Maximum Ratings" may cause permanent damage to the device. These are stress ratings only, and functional operation of the device at these or any other conditions beyond those indicated in the operational sections of the specifications is not implied. Exposure to absolute maximum rating conditions for extended periods may affect device reliability.

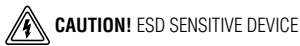

DC ELECTRICAL CHARACTERISTICS

(V_{CC} = +4.75V to +5.25V, T_A = -40°C to +85°C, R_{BIAS} = 15k Ω \pm 1%; no input signals applied. Typical values are at V_{CC} = +5V, T_A = +25°C, unless otherwise noted.)

PARAMETER	CONDITIONS	MIN	TYP	MAX	UNITS
Supply Voltage		4.75		5.25	V
Supply Current	T _A = +25°C		93	104	mA
	R _{BIAS} = 30k Ω		49		
	BIAS = unconnected		10		

AC ELECTRICAL CHARACTERISTICS

(MAX2130 EV kit, V_{CC} = +4.75V to +5.25V, R_{BIAS} = 15k Ω \pm 1%, f_{IN} = 500MHz, Z_O = 75 Ω . Typical values are at V_{CC} = +5V, T_A = +25°C, unless otherwise noted.) (Note 1)

PARAMETER	CONDITIONS	MIN	TYP	MAX	UNITS
LOW-NOISE AMPLIFIER (LNA)					
Operating Frequency Range		44		878	MHz
Gain	(Note 2)	13.4	15	16.6	dB
Gain Flatness	T _A = -40°C to +85°C (Note 2)			0.8	dB
Noise Figure			2.8	3.2	dB
Input 1dB Compression Point			2.7		dBm
	V _{CC} = +3.5V (Note 3)		2.1		
Input Third-Order Intercept Point	(Note 4)		17.5		dBm
Input Second-Order Intercept Point	(Note 5)		27		dBm
IN Return Loss	(Notes 2, 6)	7.4	8.6		dB
OUT1 Return Loss	f _{IN} = 44MHz to 878MHz		8.7		dB
Maximum Load for Stable Operation			Any load		
OUT1 to IN Isolation	(Note 2)	18	21		dB

Broadband, Two-Output, Low-Noise Amplifier for TV Tuner Applications

MAX2130

AC ELECTRICAL CHARACTERISTICS (continued)

(MAX2130 EV kit, $V_{CC} = +4.75V$ to $+5.25V$, $R_{BIAS} = 15k\Omega \pm 1\%$, $f_{IN} = 500MHz$, $Z_O = 75\Omega$. Typical values are at $V_{CC} = +5V$, $T_A = +25^\circ C$, unless otherwise noted.) (Note 1)

PARAMETER	CONDITIONS	MIN	TYP	MAX	UNITS
LOOP-OUT AMPLIFIER					
Operating Frequency Range		44		878	MHz
Gain	(Note 2)	7.1	8.7	10.2	dB
Noise Figure			4.2	4.6	dB
Input 1dB Compression Point	$V_{CC} = +3.5V$ (Note 3)		-0.5		dBm
			-3.7		
Input Third-Order Intercept Point	(Note 4)		17		dBm
Input Second-Order Intercept Point	(Note 5)		29		dBm
OUT2 Return Loss	$f_{IN} = 44MHz$ to $878MHz$		16.6		dB
Maximum Load for Stable Operation			Any load		
OUT2 to IN Isolation	(Note 2)	24.5	27		dB
OUT2 to OUT1 Isolation	(Note 2)	11.0	12.5		dB

Note 1: Specifications are guaranteed by design and characterization, except for gain which is production tested.

Note 2: Specifications are guaranteed over the operating frequency range.

Note 3: Operation possible with $V_{CC} = +3.5V$. See *Typical Operating Characteristics*.

Note 4: Two tones at 500MHz and 506MHz, -20dBm per tone.

Note 5: Two tones at 500MHz and 550MHz, -20dBm per tone.

Note 6: Output load has worst-case 6dB return loss.

Typical Operating Characteristics

(MAX2130 EV kit, $V_{CC} = +5V$, $R_{BIAS} = 15k\Omega \pm 1\%$, $T_A = +25^\circ C$, unless otherwise noted.)

SUPPLY CURRENT vs. TEMPERATURE

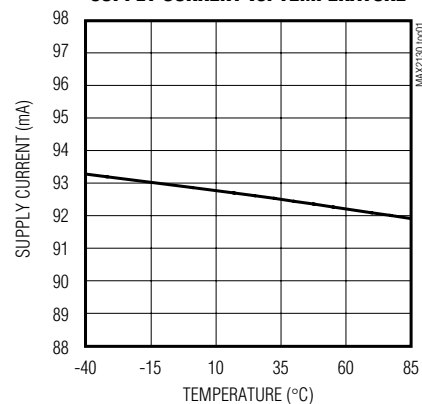

SUPPLY CURRENT vs. R_{BIAS}

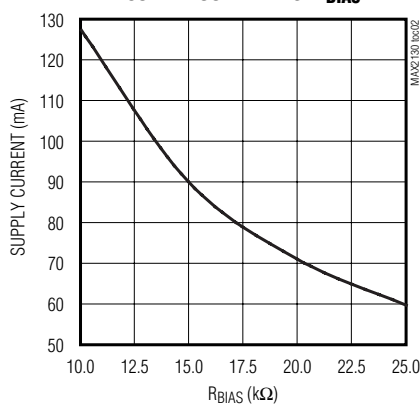

GAIN vs. FREQUENCY
R_{BIAS} = 10kΩ

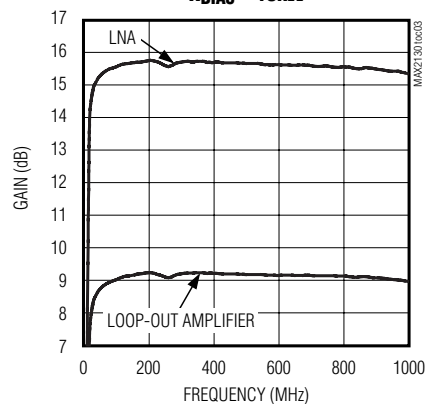

Broadband, Two-Output, Low-Noise Amplifier for TV Tuner Applications

Typical Operating Characteristics (continued)

(MAX2130 EV kit, $V_{CC} = +5V$, $R_{BIAS} = 15k\Omega \pm 1\%$, $T_A = +25^\circ C$, unless otherwise noted.)

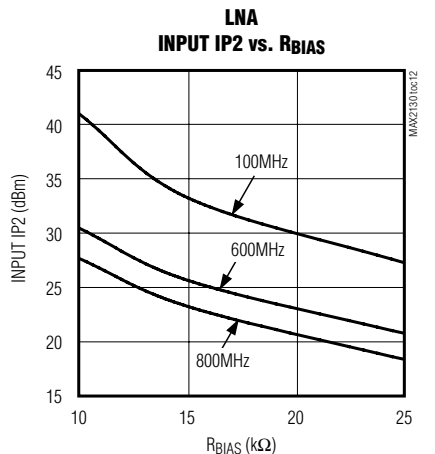
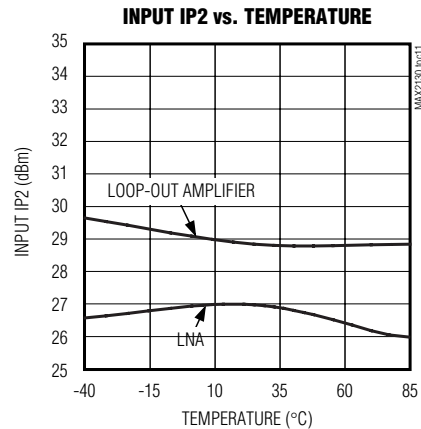
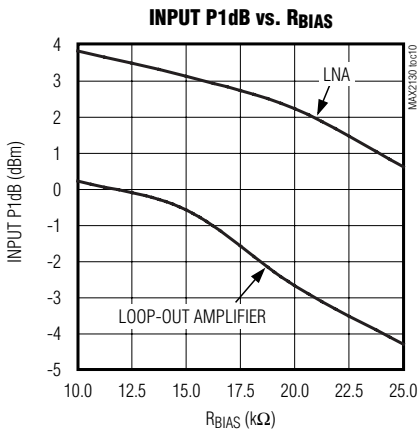
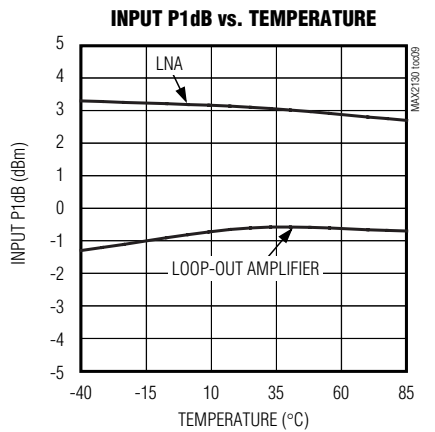
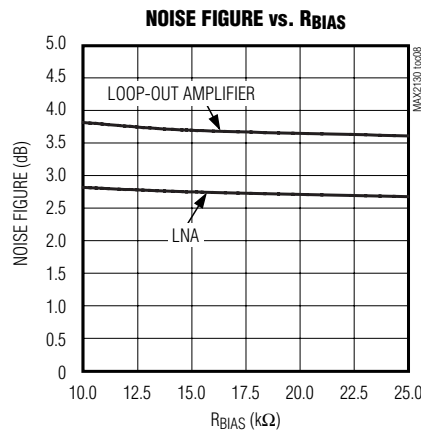
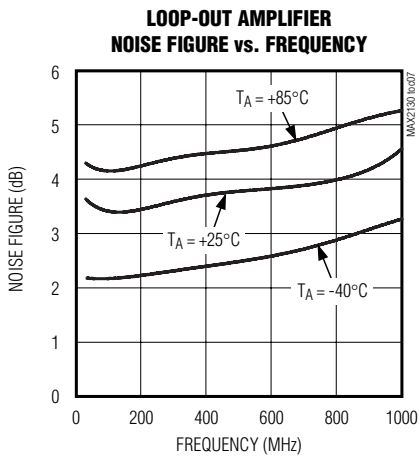
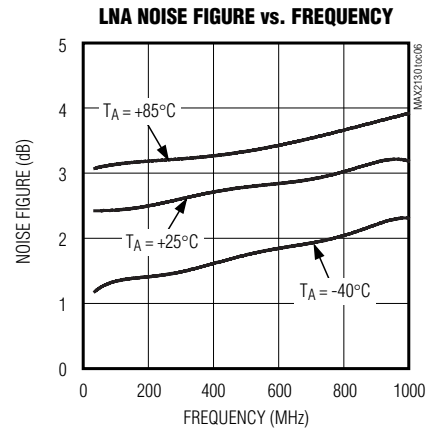
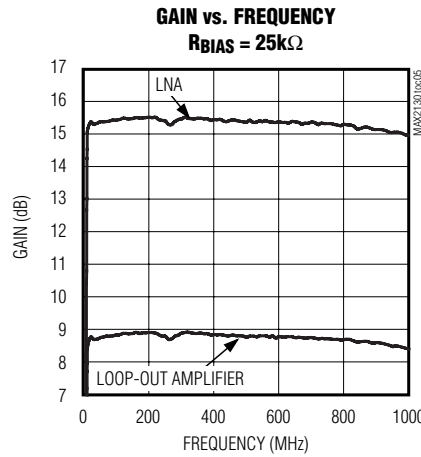
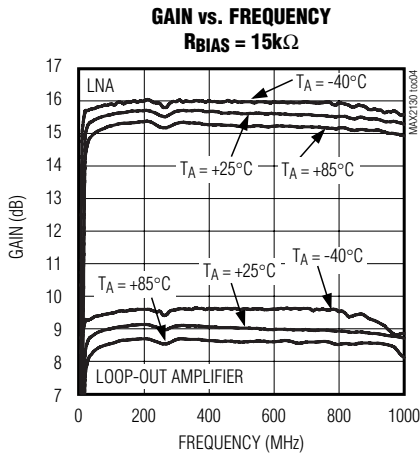

Broadband, Two-Output, Low-Noise Amplifier for TV Tuner Applications

MAX2130

Typical Operating Characteristics (continued)

(MAX2130 EV kit, $V_{CC} = +5V$, $R_{BIAS} = 15k\Omega \pm 1\%$, $T_A = +25^\circ C$, unless otherwise noted.)

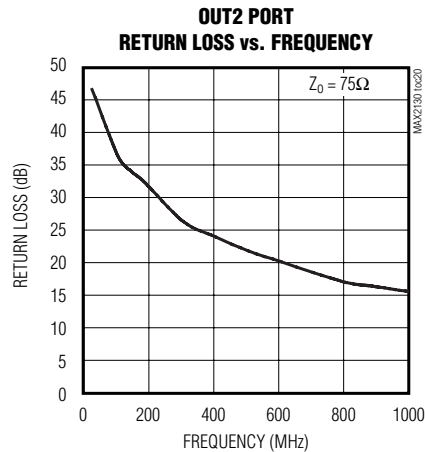
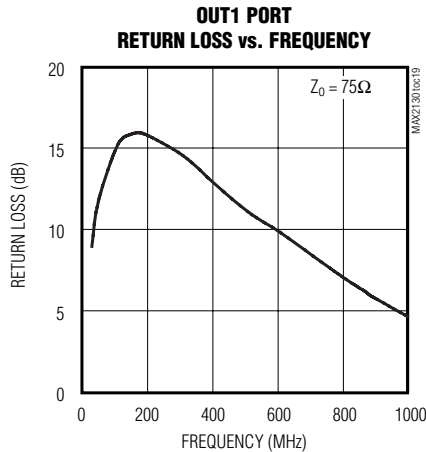
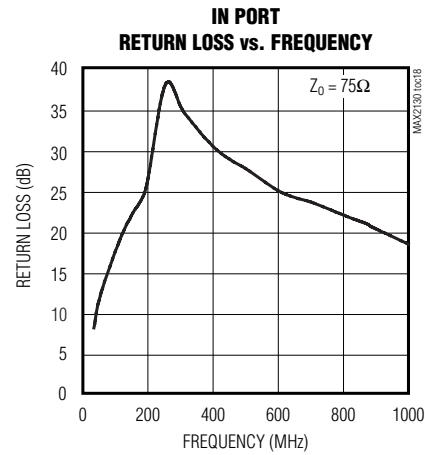
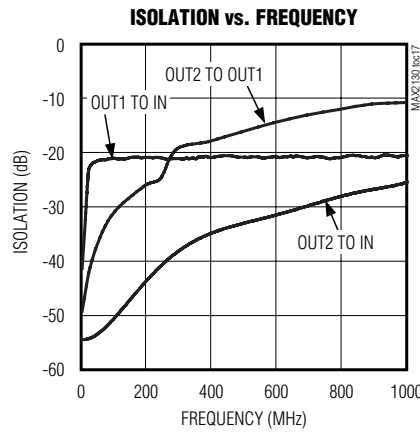
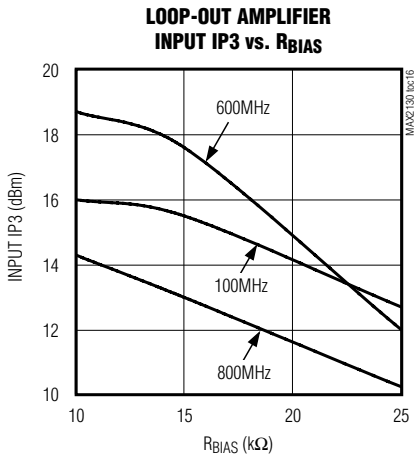
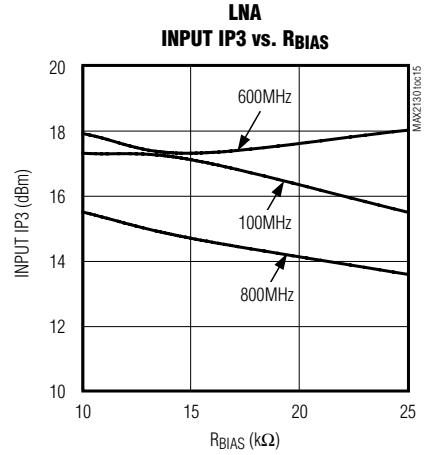
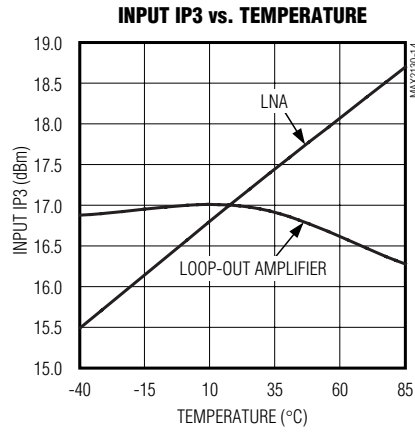
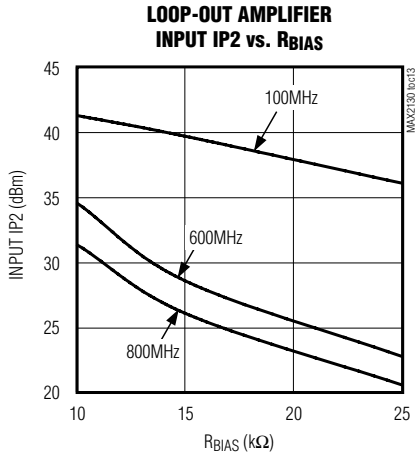

Broadband, Two-Output, Low-Noise Amplifier for TV Tuner Applications

Pin Description

PIN	NAME	FUNCTION
1	V _{CC}	Supply Voltage Input. Bypass with a 1000pF capacitor in parallel with a 47pF capacitor as close to the pin as possible. (See <i>Typical Application Circuit</i> .)
2	IN	Broadband Input to Low-Noise Amplifier and Loop-Out Amplifier. Internally matched to 75Ω. Requires 0.1μF DC-blocking capacitor. (See <i>Typical Application Circuit</i> .)
3	BIAS	Bias-Setting Resistor Connection. Connect a resistor, R _{BIAS} , from BIAS to GND to set the linearity and supply current of the LNA and the loop-out amplifier.
4, 6, 7, EP	GND	Ground. Connect to ground plane with a low-inductance connection. Solder exposed paddle evenly to the board groundplane.
5	OUT2	Output of Loop-Out Amplifier. Requires a 0.1μF DC-blocking capacitor. (See <i>Typical Application Circuit</i> .)
8	OUT1	Open-Collector Output of Low-Noise Amplifier. Requires a pullup inductor to V _{CC} , as well as a 0.1μF DC-blocking capacitor. (See <i>Typical Application Circuit</i> .)

Detailed Description

The MAX2130 is a broadband, high-gain, low-distortion low-noise amplifier (LNA) with two outputs intended for operation over the 44MHz to 878MHz frequency range. The device operates from a +5V supply and features externally adjustable bias control circuitry that allows minimum linearity requirements to be met while reducing current consumption.

Input

The IN port is a broadband 75Ω input that provides a guaranteed minimum input return loss of 7.4dB (allowing for 2:1 VSWR at output) across the 44MHz to 878MHz frequency range. AC-couple the IN port with a 0.1μF DC-blocking capacitor.

Outputs

The OUT1 port is a broadband, 75Ω, open-collector output for the LNA. It requires a pullup inductor to V_{CC} for proper biasing, as well as a 0.1μF DC-blocking capacitor. See the *Applications Information* section for proper inductor selection.

The OUT2 port is a broadband, 75Ω output for the loop-out amplifier. The loop-out amplifier is internally biased and does not require a pullup inductor. AC-couple the OUT2 port with a 0.1μF DC-blocking capacitor.

Bias Circuitry

The linearity and supply current for both amplifiers are externally programmable with a single resistor, R_{BIAS}, from BIAS to GND. A nominal resistor value of 15kΩ sets an input IP3 of +17.5dBm, an input IP2 of +27dBm, and a supply current of 93mA. Decrease the

resistor value to improve linearity at the cost of increased supply current. Increase the resistor value to decrease supply current and degrade linearity. Use resistor values greater than 10kΩ. Gain is not significantly affected by the R_{BIAS} value.

Applications Information

Inductor Selection

The OUT1 port of the LNA requires a pull-up inductor to V_{CC} for proper biasing. The exact value of the inductor is not important as long as it has broadband impedance >150Ω (<500Ω) at 10MHz across the 44MHz to 878MHz frequency band. Table 1 is a list of recommended inductors.

Table 1. OUT1 Pullup Inductor Recommended Components

PART NUMBER	MANUFACTURER
BLM11A221S	Murata
BLM11A471SG	Murata
BLM10A221SG	Murata
BLM21A331SG	Murata

Broadband, Two-Output, Low-Noise Amplifier for TV Tuner Applications

Dynamic Linearity Adjustment

The LNA and loop-out amplifier linearity can be dynamically adjusted by varying the amount of current sourced by the BIAS port. The BIAS port is internally biased to 1.2V. A resistor, R_{BIAS} , connected from BIAS to ground sets the bias current. An additional resistor, R_{ADJ} , placed from the BIAS port to an external voltage source, such as a digital-to-analog converter (DAC), varies the current sourced by the BIAS port. Choosing $R_{ADJ} = R_{BIAS} = 20k\Omega$ and varying the voltage of the DAC from ground to 2.4V effectively varies the resistance seen from the BIAS port from $10k\Omega$ to an open circuit. See *Typical Application Circuit*.

The DAC output voltage, V_{ADJ} , required to set an equivalent resistance to ground, R_{EQ} , seen by the BIAS port, can be calculated with the following equation:

$$V_{ADJ} = 2.4V - (R_{BIAS} \times V_{BIAS}) / R_{EQ}$$

where $R_{ADJ} = R_{BIAS}$, $V_{BIAS} = 1.2V$, $R_{EQ} \geq 10k\Omega$.

Power-Supply Bypassing

Proper voltage-supply bypassing is essential for high-frequency circuit stability. Bypass the V_{CC} pin with a 1000pF capacitor in parallel with a 47pF capacitor, located as close to the V_{CC} pin as possible. Refer to the MAX2130 EV kit for additional information.

Pin Configuration

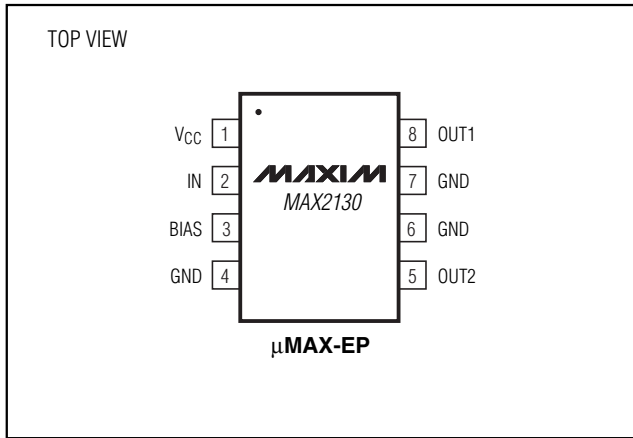

Chip Information

TRANSISTOR COUNT: 167

Broadband, Two-Output, Low-Noise Amplifier for TV Tuner Applications

Package Information

(The package drawing(s) in this data sheet may not reflect the most current specifications. For the latest package outline information go to www.maxim-ic.com/packages.)

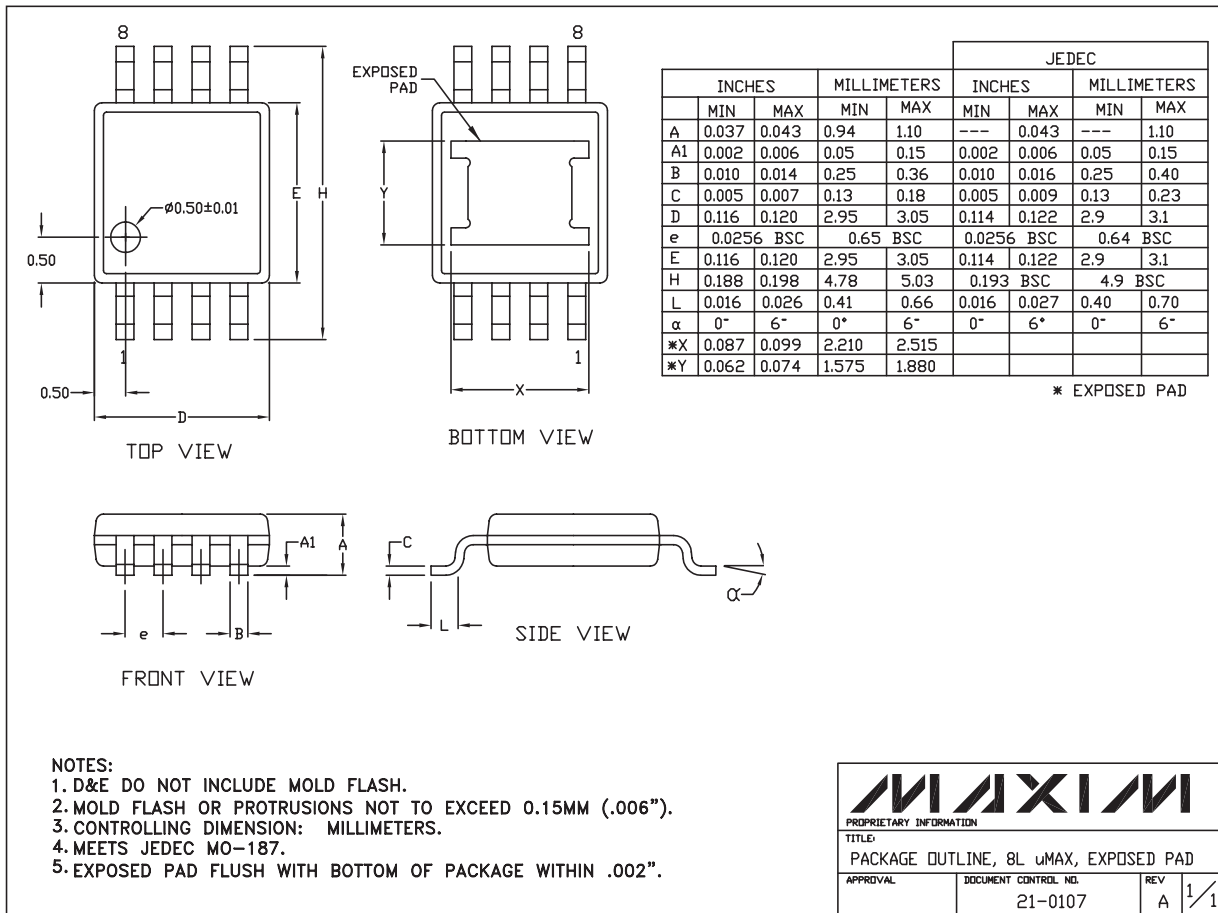

Maxim cannot assume responsibility for use of any circuitry other than circuitry entirely embodied in a Maxim product. No circuit patent licenses are implied. Maxim reserves the right to change the circuitry and specifications without notice at any time.

8 **Maxim Integrated Products, 120 San Gabriel Drive, Sunnyvale, CA 94086 408-737-7600**