



10Gbps, 3.3V Low-Power Transimpedance Amplifier with RSSI

MAX3970

General Description

The MAX3970 is a compact, low-power transimpedance amplifier (TIA) optimized for use in 10Gbps optical receivers. The TIA provides transimpedance at 600V/A with 50Ω differential CML outputs. The MAX3970 has a typical input-referred noise of 1.1μA, and when coupled with a high-speed photodiode, achieves -18dBm sensitivity and +2mA input overload. A received-signal strength indicator (RSSI) simplifies optical assembly. The circuit operates from a single 3.3V supply over a junction temperature range from 0°C to +110°C.

Features

- ◆ 150mW Power Dissipation at 3.3V Supply
- ◆ 1.1μA_{RMS} Noise (-18dBm Sensitivity)
- ◆ 9GHz Bandwidth
- ◆ 2mA_{p-p} Input Overload
- ◆ Received-Signal Strength Indication
- ◆ 8psp-p Typical Jitter Generation at 1.3mA_{p-p} Input Current
- ◆ 600V/A Transimpedance

Applications

10.3Gbps Ethernet Optical Receivers
 OC-192 VSR Optical Receivers
 Fibre-Channel Optical Receivers

Ordering Information

PART	TEMP RANGE	PIN-PACKAGE
MAX3970U/D	0°C to +85°C	Dice

Note: Dice are designed to operate over a 0°C to +110°C junction temperature (T_J) range, but are tested and guaranteed at $T_A = +25^\circ\text{C}$.

Typical Application Circuit

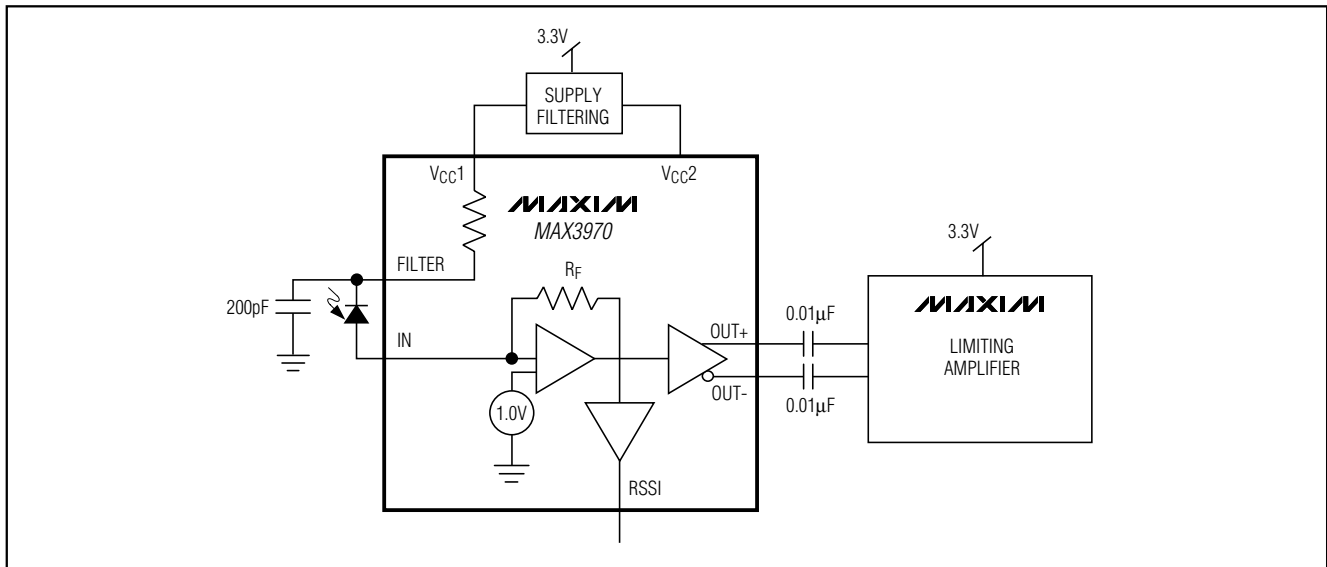

10Gbps, 3.3V Low-Power Transimpedance Amplifier with RSSI

ABSOLUTE MAXIMUM RATINGS

Terminal Voltage		Operating Junction Temperature Range	-40°C to +125°C
Voltage V _{CC1} and V _{CC2}	-0.3V to +5.0V	Storage Temperature Range	-60°C to +150°C
Voltage at FILTER	-0.3V to (V _{CC1} + 0.3V)	Die Attach Process Temperature	+400°C
Voltage at OUT+, OUT-, RSSI	0V to (V _{CC} + 0.5V)		
Input Current			
IN, TEST	-5mA to +5mA		

Stresses beyond those listed under "Absolute Maximum Ratings" may cause permanent damage to the device. These are stress ratings only, and functional operation of the device at these or any other conditions beyond those indicated in the operational sections of the specifications is not implied. Exposure to absolute maximum rating conditions for extended periods may affect device reliability.

ELECTRICAL CHARACTERISTICS

(V_{CC} = +3.0V to +3.6V, output loads = 50Ω to V_{CC}, T_J = 0°C to +110°C. Typical values are at V_{CC} = +3.3V, C_{IN} = 0.25pF, L_{IN} = 1.7nH, T_A = +25°C, unless otherwise noted.) (Note 1)

PARAMETER	SYMBOL	CONDITIONS	MIN	TYP	MAX	UNITS
Supply Current	I _{CC}			46	62	mA
Maximum DC Input Current	I _{IN-MAX}		1.6			mA
Input Linear Range		0.95 < linearity < 1.05	100	130		μA _{P-P}
Input-Referred RMS Noise	i _n	f = 7.5GHz (Note 2)		1.1	1.45	μA
		f = 10GHz (Note 2)		1.1	1.45	
Input-Referred Noise Density		f = 10GHz (Note 2)		11		pA/√Hz
Output Resistance (per side)	R _{OUT}		43	50	58	Ω
Small-Signal Transimpedance	Z ₂₁	Differential output 10μA _{P-P} < Input < 100μA _{P-P}	450	600	875	Ω
Small-Signal Bandwidth	BW		7.4	9	13.2	GHz
Low-Frequency Cutoff				70	150	kHz
Deterministic Jitter	DJ	I _{IN} < 1.3mA		8		pSP-P
		I _{IN} = 2.0mA		16	22	
Input Bias Voltage	V _{IN}			0.9	0.96	V
RSSI Gain		I _{IN} = 100μA to 1mA	900	1200	1500	V/A
		I _{IN} = 10μA to 100μA	1200	1800	3000	
RSSI Bandwidth			10	70		kHz
Photodiode Filter Resistance	R _{FILTER}		330	410	500	Ω
Maximum Differential Output Voltage	V _{OD-MAX}	Input = 1mA _{P-P}	350	470	700	mV _{P-P}

Note 1: AC characteristics are guaranteed by design and characterization.

Note 2: Input-referred noise is calculated as RMS output noise / (gain at f = 10MHz). Noise density is (input-referred noise) / √bandwidth. Noise measurements are made using 4-pole Bessel filters.

10Gbps, 3.3V Low-Power Transimpedance Amplifier with RSSI

Typical Operating Characteristics

($V_{CC} = +3.3V$, $T_A = +25^\circ C$, input bondwire inductance = 1.0nH, unless otherwise noted. C_{IN} is total source capacitance to die. All measurements made on MAX3970 EV Kit.)

MAX3970

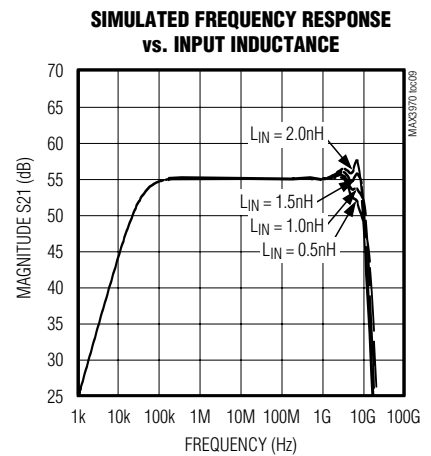
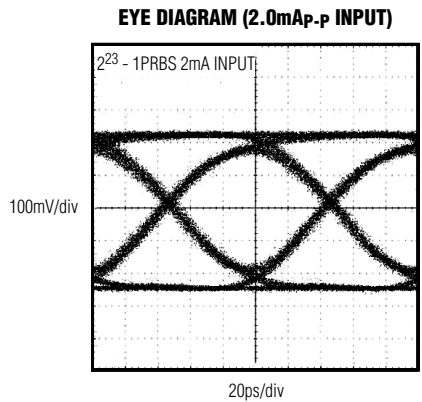
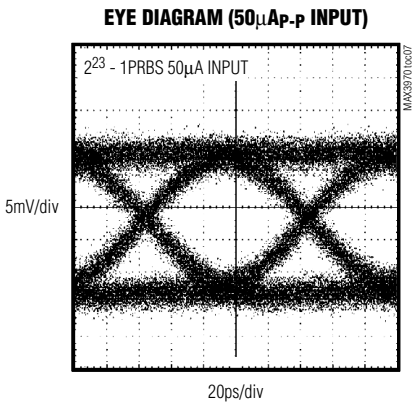
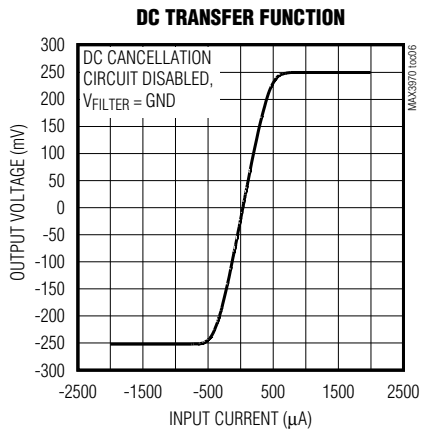
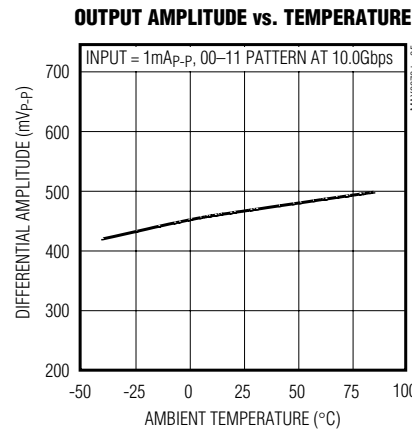
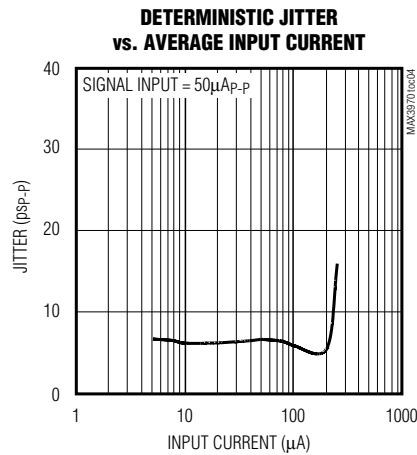
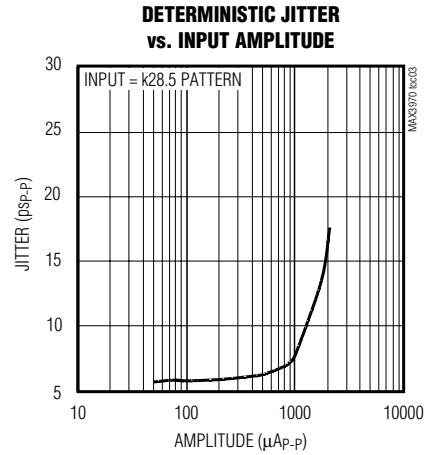
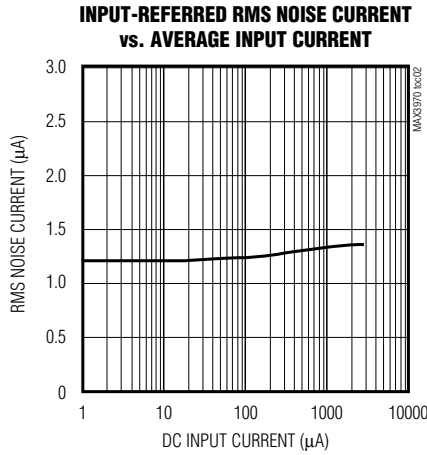
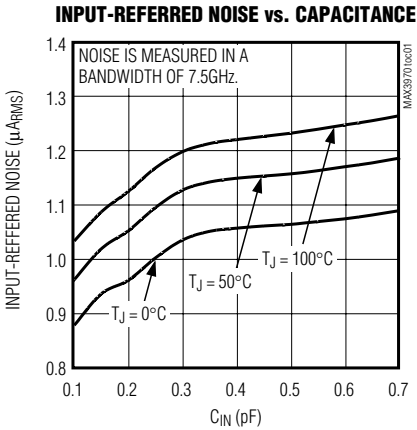

10Gbps, 3.3V Low-Power Transimpedance Amplifier with RSSI

Typical Operating Characteristics (continued)

($V_{CC} = +3.3V$, $T_A = +25^\circ C$, input bondwire inductance = 1.0nH, unless otherwise noted. C_{IN} is total source capacitance to die. All measurements made on MAX3970 EV Kit.)

SIMULATED FREQUENCY RESPONSE vs. INPUT INDUCTANCE

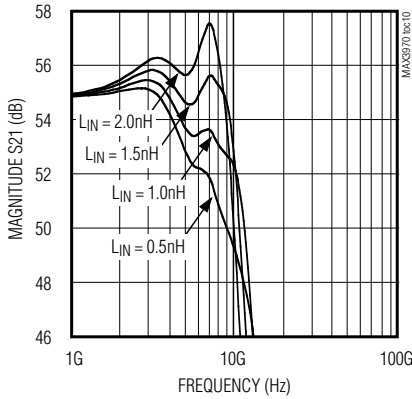

POWER-SUPPLY REJECTION RATIO vs. FREQUENCY

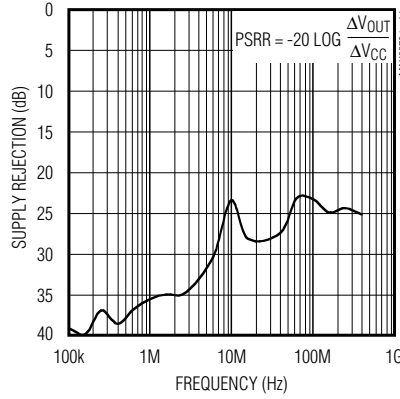

OUTPUT COMMON-MODE VOLTAGE (REFERENCED TO V_{CC}) vs. TEMPERATURE

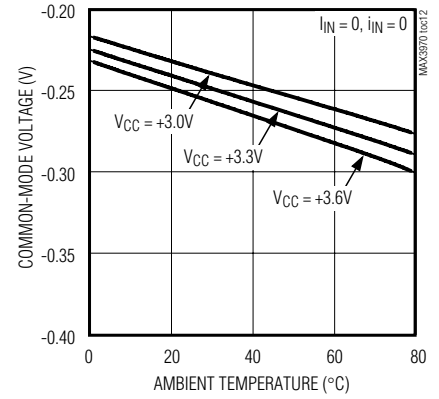

S22 vs. FREQUENCY

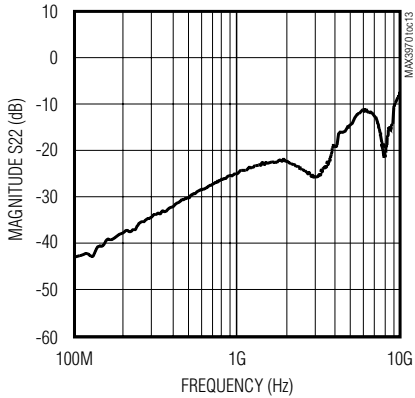

OUTPUT VSWR (DIFFERENTIAL)

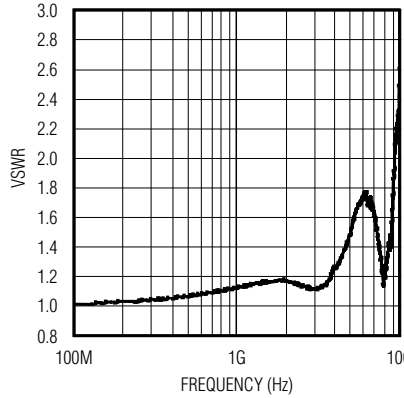

RSSI OUTPUT VOLTAGE vs. AVERAGE INPUT CURRENT

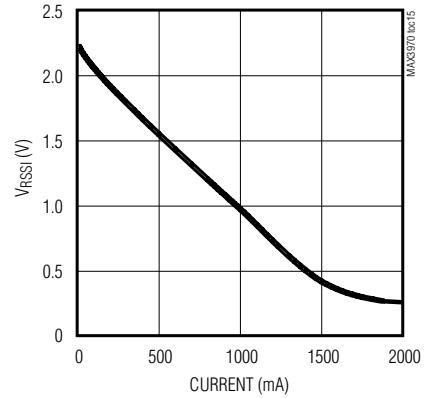

SIMULATED SMALL-SIGNAL BANDWIDTH vs. CAPACITANCE

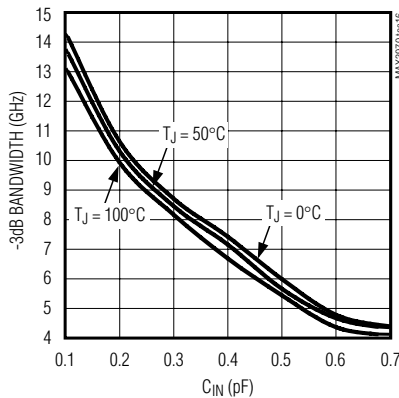

SMALL-SIGNAL TRANSIMPEDANCE vs. TEMPERATURE

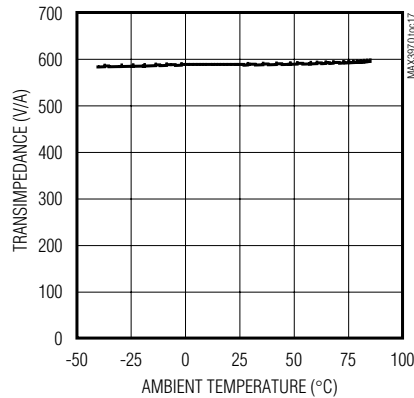

10Gbps, 3.3V Low-Power Transimpedance Amplifier with RSSI

MAX3970

Pad Description

PAD	NAME	FUNCTION
BP1, BP2, BP18	V _{CC1}	Power Supply. Provides supply voltage to input circuitry and bias to the photodiode via an internal 410Ω resistor.
BP3	FILTER	Provides bias voltage for the photodiode through a 410Ω resistor to V _{CC1} . When grounded, this pin disables the DC cancellation circuit to allow a DC path from IN to OUT+ and OUT- for testing.
BP4	TEST	Test Pad. This pad is connected to IN via a 1kΩ resistor.
BP5	IN	Amplifier Input. Accepts photodiode input current.
BP6, BP7	GND1	Ground
BP8, BP9	GND2	Ground
BP10, BP13	GND3	Ground
BP11	OUT-	Negative CML Output. Current flowing into IN causes OUT- to decrease.
BP12	OUT+	Positive CML Output. Current flowing into IN causes OUT+ to increase.
BP14, BP15, BP16	V _{CC2}	Power Supply. Provides supply voltage to the output buffers.
BP17	RSSI	Received-Signal Strength Indicator. This pin provides a voltage proportional to the DC input current. Monitor this output during assembly to optimally align the photodiode to the optics.

Detailed Description

The MAX3970 transimpedance amplifier is optimized for 10Gbps fiber optic receivers. Figure 1 is a functional diagram of the MAX3970, which comprises a transimpedance amplifier, a voltage amplifier, an output buffer, a received-signal strength indicator, and a DC-cancellation circuit.

Transimpedance Amplifier

Photodiode signal current flows into the summing node of a high-gain amplifier. Shunt feedback through R_F converts this current into a voltage with a gain of approximately 400Ω. Schottky diodes clamp the output voltage for large input currents, as shown in Figure 2.

Voltage Amplifier

The voltage amplifier converts single-ended signals to differential signals and introduces approximately 4dB of gain.

Output Buffer

The output buffer is optimized to drive a 100Ω differential load between OUT+ and OUT-. Although short-circuit protection is provided, this stage will not drive a 50Ω load to ground. For proper operation, the load must be AC-coupled. For large signals, the output buffer produces a limited, 500mV_{P-P} differential output voltage.

Terminate the MAX3970 outputs differentially for optimum supply-noise rejection. If a single-ended output is required, terminate the used and unused outputs similarly.

DC Cancellation Circuit

The DC cancellation circuit centers the input signal within the transimpedance amplifier's linear range (Figure 3). Low-frequency feedback is employed to remove the input signal's DC component.

The DC cancellation circuit is internally compensated and therefore does not require external capacitors. This circuit minimizes pulse-width distortion for data sequences that exhibit a 50% mark density. A mark density significantly different from 50% will cause the MAX3970 to generate pulse-width distortion.

Received-Signal Strength Indicator

The received-signal strength indicator (RSSI) provides a voltage proportional to the DC input current. The RSSI circuitry is designed to drive a 10kΩ load and is used during the assembly process to optimally align the photodiode. The lowpass filter in the DC cancellation circuit determines the response time of the RSSI circuit.

Design Procedure

Power Supply

The MAX3970 requires wide-band power-supply decoupling. Power-supply bypassing should provide low impedance between V_{CC} and ground for frequencies between 50kHz and 10GHz. Use LC filtering at the main supply terminal and decoupling capacitors as close to the die as possible.

10Gbps, 3.3V Low-Power Transimpedance Amplifier with RSSI

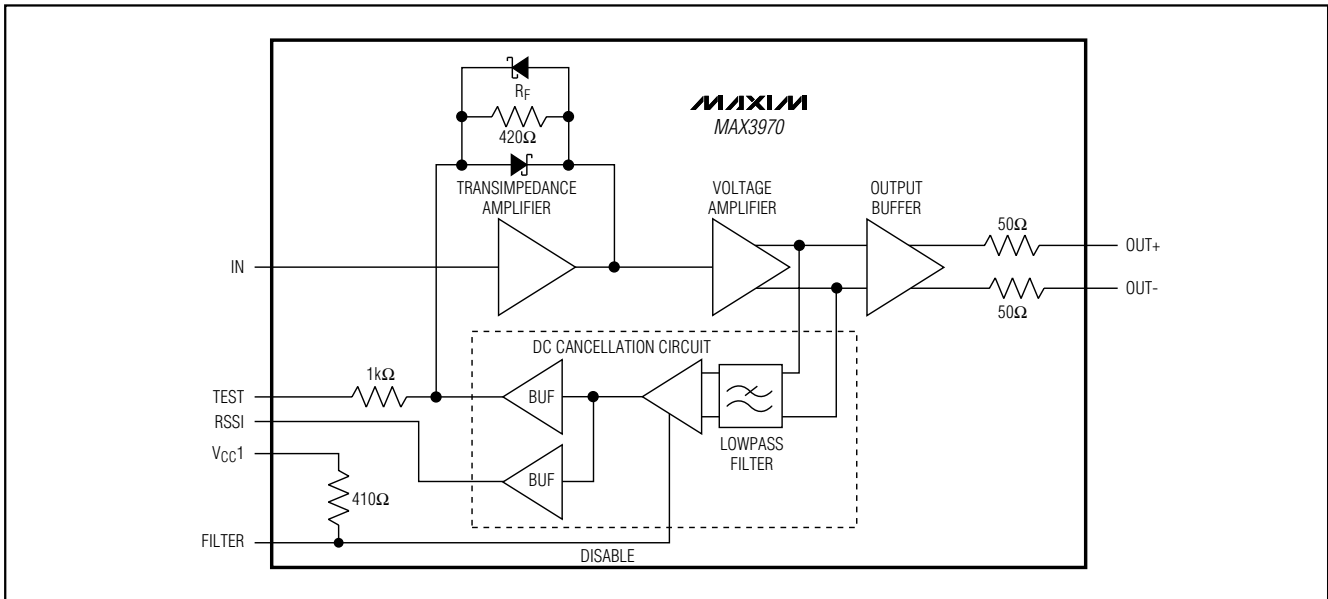

Figure 1. Functional Diagram

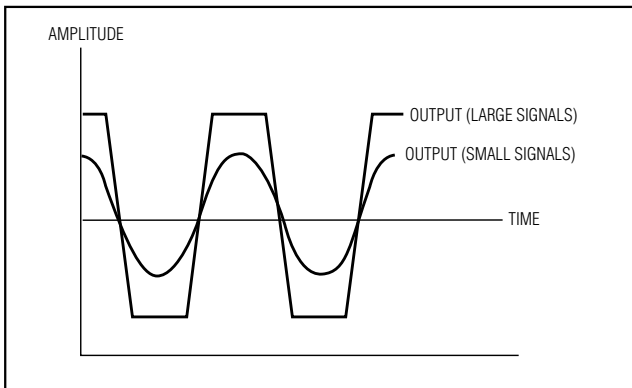

Figure 2. MAX3970 Limited Output

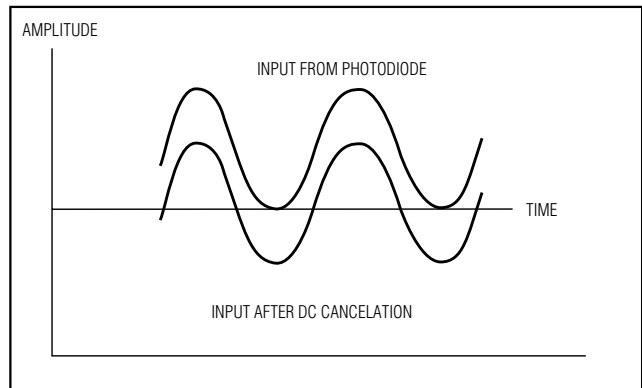

Figure 3. Effects of DC Cancellation on Input Signal

Photodiode Filter

Supply-voltage noise at the cathode of the photodiode produces a current $I = C_{PD} \Delta V / \Delta t$, which reduces the receiver sensitivity (C_{PD} is the photodiode capacitance). The MAX3970 contains an internal lowpass filter to reduce photodiode noise current and improve receiver sensitivity. An external capacitor connected between the FILTER pad and ground can further reduce this noise (see the *Typical Application Circuit*). Current generated by supply-noise voltage is divided between the filter capacitance and photodiode capacitance. Assuming the filter capacitance is much larger than the photodiode capacitance, the input noise current due to supply noise is:

$$I_{NOISE} = (V_{NOISE})(C_{PD}) / (R_{FILTER})(C_{FILTER})$$

where C_{FILTER} is the external capacitance plus the internal 22pF capacitor. If the amount of tolerable noise is known, the filter capacitance can be easily selected:

$$C_{FILTER} = (V_{NOISE})(C_{PD}) / (R_{FILTER})(I_{NOISE})$$

For example, with maximum noise voltage = 100mVp-p, $C_{PD} = 0.25\text{pF}$, $R_{FILTER} = 410\Omega$, and I_{NOISE} selected to be 300nA (1/4 of the MAX3970's input noise):

$$C_{FILTER} = (100\text{mV})(0.25\text{pF}) / (410\Omega)(300\text{nA}) \approx 200\text{pF}$$

Thus, the required external filter capacitance is $200\text{pF} - 22\text{pF} = 178\text{pF}$.

10Gbps, 3.3V Low-Power Transimpedance Amplifier with RSSI

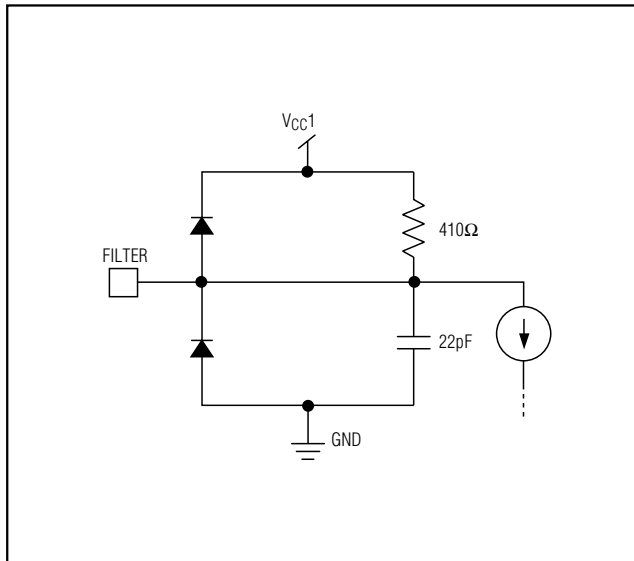

Figure 6. FILTER Pad

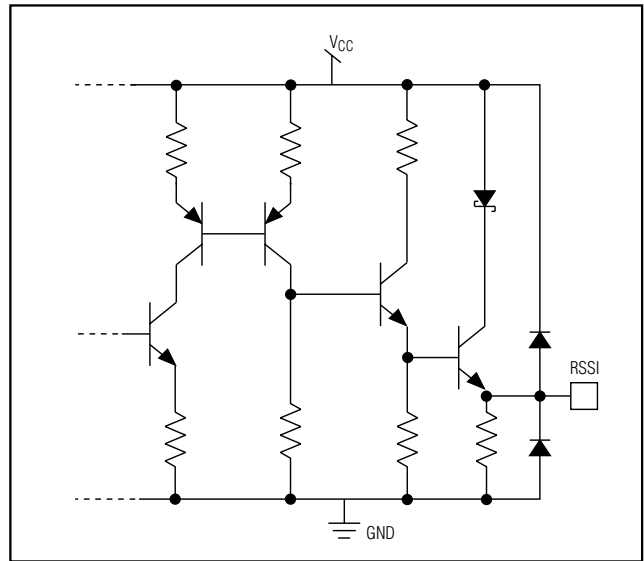

Figure 7. RSSI Pad

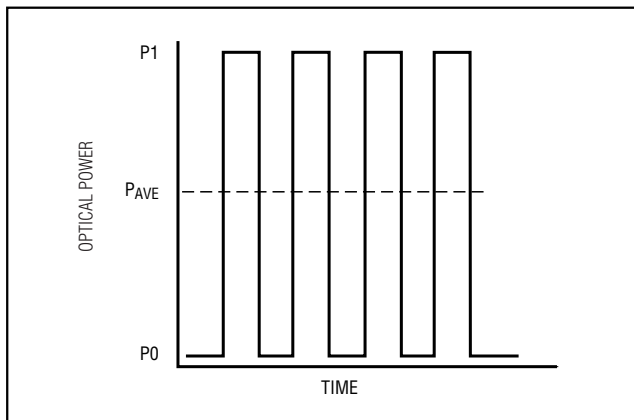

Figure 8. Optical Power Relations

Input Optical Overload

The overload is the largest input that the MAX3970 accepts while meeting specifications. Optical overload can be estimated in terms of average power with the following equation:

$$\text{Overload} = 10\log\left(\frac{2\text{mA}}{2 \times \rho} \times 1000\right) \text{dBm}$$

Optical Linear Range

The MAX3970 has high gain, and operates in a linear range for inputs not exceeding:

$$\text{Linear Range} = 10\log\left(\frac{60\mu\text{A}(r_e + 1)}{2 \times \rho \times (r_e - 1)} \times 1000\right) \text{dBm}$$

Optical Sensitivity Calculation

The MAX3970 input-referred RMS noise current i_n generally determines the receiver sensitivity. To obtain a system bit error rate (BER) of 1×10^{-12} , the signal-to-noise ratio must always exceed 14.1. The input sensitivity, expressed in average power, can be estimated as:

$$\text{Sensitivity} = 10\log\left(\frac{14.1 \times i_n \times (r_e + 1)}{2 \times \rho \times (r_e - 1)} \times 1000\right) \text{dBm}$$

where ρ is the photodiode responsivity in A/W.

10Gbps, 3.3V Low-Power Transimpedance Amplifier with RSSI

Table 1. Optical Power Relations*

PARAMETER	SYMBOL	RELATION
Average Power	P_{AVG}	$P_{AVG} = (P_0 + P_1) / 2$
Extinction Ratio	r_e	$r_e = P_1 / P_0$
Optical Power of a "1"	P_1	$P_1 = 2P_{AVG} \frac{r_e}{r_e + 1}$
Optical Power of a "0"	P_0	$P_0 = 2P_{AVG} / (r_e + 1)$
Optical Modulation Amplitude	P_{IN}	$P_{IN} = P_1 - P_0 = 2P_{AVG} \frac{r_e - 1}{r_e + 1}$

*Assuming a 50% average mark density.

Table 2. MAX3970 Bondpad Information

PAD	NAME	COORDINATES	
		X	Y
BP1	VCC1	0	799.4
BP2	VCC1	0	673.4
BP3	FILTER	0	547.4
BP4	TEST	0	421.4
BP5	IN	0	295.4
BP6	GND1	0	169.4
BP7	GND1	129.8	0
BP8	GND2	255.8	0
BP9	GND2	381.8	0
BP10	GND3	512	170.8
BP11	OUT-	512	296.8
BP12	OUT+	512	422.8
BP13	GND3	512	548.8
BP14	VCC2	512	674.8
BP15	VCC2	512	800.8
BP16	VCC2	381.8	971.6
BP17	RSSI	255.8	971.6
BP18	VCC1	129.8	971.6

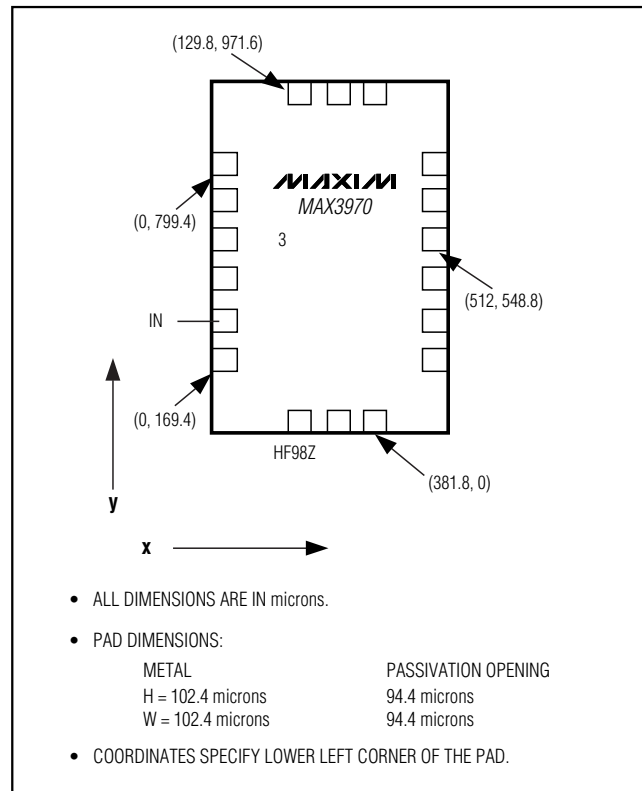
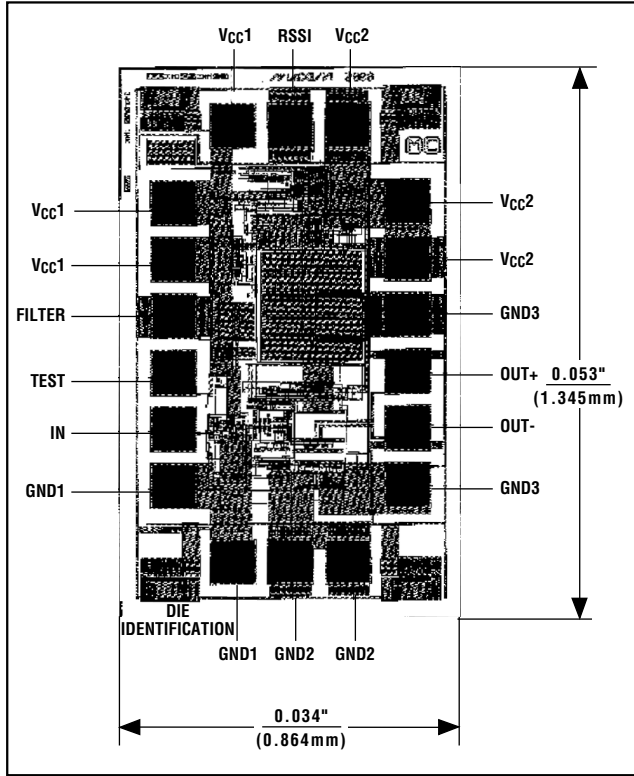

Figure 9. Bondpad Diagram

MAX3970

10Gbps, 3.3V Low-Power Transimpedance Amplifier with RSSI

Chip Topography



Chip Information

TRANSISTOR COUNT: 125

PROCESS: SILICON GERMANIUM BIPOLAR

Maxim cannot assume responsibility for use of any circuitry other than circuitry entirely embodied in a Maxim product. No circuit patent licenses are implied. Maxim reserves the right to change the circuitry and specifications without notice at any time.

10 **Maxim Integrated Products, 120 San Gabriel Drive, Sunnyvale, CA 94086 408-737-7600**