



High-Speed, Single-Supply, Gain of +2, Closed-Loop, Rail-to-Rail Buffers with Enable

General Description

The MAX4214/MAX4215/MAX4217/MAX4219/MAX4222 are precision, closed-loop, gain of +2 (or -1) buffers featuring high slew rates, high output current drive, and low differential gain and phase error. They operate with a single +3.15V to +11V supply or with $\pm 1.575V$ to $\pm 5.5V$ dual supplies. The input common-mode voltage range extends 100mV beyond the negative power-supply rail, and the output swings Rail-to-Rail®.

These devices require only 5.5mA of quiescent supply current while achieving a 230MHz -3dB bandwidth and a 600V/ μ s slew rate. In addition, the MAX4215/MAX4219 have a disable feature that reduces the supply current to 400 μ A per buffer. Input voltage noise is only 10nV/ \sqrt{Hz} , and input current noise is only 1.3pA/ \sqrt{Hz} . This buffer family is ideal for low-power/low-voltage applications requiring wide bandwidth, such as video, communications, and instrumentation systems. For space-sensitive applications, the MAX4214 comes in a miniature 5-pin SOT23 package.

Ordering Information

PART	TEMP. RANGE	PIN-PACKAGE	SOT TOP MARK
MAX4214EUK-T	-40°C to +85°C	5 SOT23-5	ABAH
MAX4215ESA	-40°C to +85°C	8 SO	—
MAX4215EUA	-40°C to +85°C	8 μ MAX	—
MAX4217ESA	-40°C to +85°C	8 SO	—
MAX4217EUA	-40°C to +85°C	8 μ MAX	—
MAX4219ESD	-40°C to +85°C	14 SO	—
MAX4219EEE	-40°C to +85°C	16 QSOP	—
MAX4222ESD	-40°C to +85°C	14 SO	—
MAX4222EEE	-40°C to +85°C	16 QSOP	—

Applications

Battery-Powered Instruments
Video Line Driver
Analog-to-Digital Converter Interface
CCD Imaging Systems
Video Routing and Switching Systems
Video Multiplexing Applications

Typical Application Circuit appears at end of data sheet.

Rail-to-Rail is a registered trademark of Nippon Motorola, Inc.

Features

- ◆ Internal Precision Resistors for Closed-Loop Gains of +2V/V or -1V/V
- ◆ High Speed:
 - 230MHz -3dB Bandwidth
 - 90MHz 0.1dB Gain Flatness (MAX4219/22)
 - 600V/ μ s Slew Rate
- ◆ Single 3.3V/5.0V Operation
- ◆ Outputs Swing Rail-to-Rail
- ◆ Input Common-Mode Range Extends Beyond VEE
- ◆ Low Differential Gain/Phase Error: 0.03%/0.04°
- ◆ Low Distortion at 5MHz:
 - 72dBc SFDR
 - 71dB Total Harmonic Distortion
- ◆ High Output Drive: $\pm 120mA$
- ◆ Low 5.5mA Supply Current
- ◆ 400 μ A Shutdown Supply Current (MAX4215/19)
- ◆ Space-Saving SOT23-5, μ MAX, or QSOP Packages

Selector Guide

PART	NO. OF AMPS	ENABLE	PIN-PACKAGE
MAX4214	1	No	5 SOT23
MAX4215	1	Yes	8 SO/ μ MAX
MAX4217	2	No	8 SO/ μ MAX
MAX4219	3	Yes	14 SO, 16 QSOP
MAX4222	4	No	14 SO, 16 QSOP

Pin Configurations

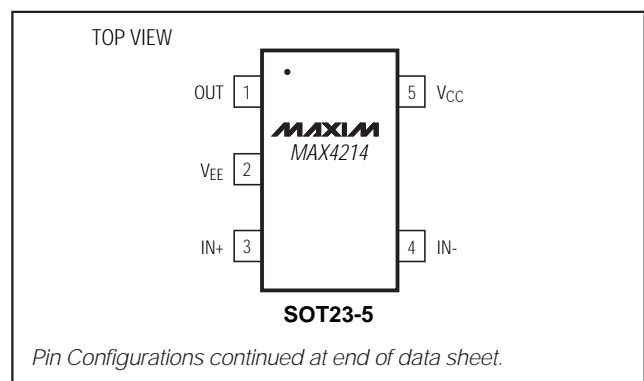

Maxim Integrated Products 1

For free samples & the latest literature: <http://www.maxim-ic.com>, or phone 1-800-998-8800.
For small orders, phone 408-737-7600 ext. 3468.

MAX4214/MAX4215/MAX4217/MAX4219/MAX4222

High-Speed, Single-Supply, Gain of +2, Closed-Loop, Rail-to-Rail Buffers with Enable

ABSOLUTE MAXIMUM RATINGS

Supply Voltage (V_{CC} to V_{EE})	12V	8-pin μ MAX (derate 4.1mW/°C above +70°C)	330mW
IN_- , IN_+ , OUT_- , EN_-	($V_{EE} - 0.3V$) to ($V_{CC} + 0.3V$)	14-pin SO (derate 8.3mW/°C above +70°C)	667mW
Output Short-Circuit Duration to V_{CC} or V_{EE}	Continuous	16-pin QSOP (derate 8.3mW/°C above +70°C)	667mW
Continuous Power Dissipation ($T_A = +70^\circ C$)		Operating Temperature Range	-40°C to +85°C
5-pin SOT23 (derate 7.1mW/°C above +70°C)	571mW	Storage Temperature Range	-65°C to +150°C
8-pin SO (derate 5.9mW/°C above +70°C)	471mW	Lead Temperature (soldering, 10sec)	+300°C

Stresses beyond those listed under "Absolute Maximum Ratings" may cause permanent damage to the device. These are stress ratings only, and functional operation of the device at these or any other conditions beyond those indicated in the operational sections of the specifications is not implied. Exposure to absolute maximum rating conditions for extended periods may affect device reliability.

DC ELECTRICAL CHARACTERISTICS

($V_{CC} = +5V$, $V_{EE} = 0V$, $IN_- = 0V$, $EN_- = 5V$, $R_L = \infty$ to $0V$, $V_{OUT} = V_{CC}/2$, noninverting configuration, $T_A = T_{MIN}$ to T_{MAX} , unless otherwise noted. Typical values are at $T_A = +25^\circ C$.) (Note 1)

PARAMETER	SYMBOL	CONDITIONS		MIN	TYP	MAX	UNITS
Operating Supply Voltage Range		V_{CC} to V_{EE} , guaranteed by PSRR tests		3.15		11.0	V
Input Voltage Range	V_{IN}	IN_+		$V_{EE} - 0.1$		$V_{CC} - 2.25$	V
		IN_-		$V_{EE} - 0.1$		$V_{CC} + 0.1$	
Input Offset Voltage	V_{OS}	$R_L = 50\Omega$	SO, QSOP		4	10	mV
			SOT23-5, μ MAX		4	15	
Input Offset Voltage Drift	TCV_{OS}				8		$\mu V/^\circ C$
Input Offset Voltage Matching		Between any two channels for MAX4217/MAX4219/MAX4222			1		mV
Input Bias Current	I_B	IN_+			5.4	12	μA
Input Resistance	R_{IN}	IN_+ , over input voltage range			3		$M\Omega$
Voltage Gain	A_V	$R_L \geq 50\Omega$, ($V_{EE} + 0.5V$) $\leq V_{OUT} \leq (V_{CC} - 2.0V)$		1.9	2	2.1	V/V
Power-Supply Rejection Ratio (Note 2)	PSRR	$V_{CC} = 5V$, $V_{EE} = 0V$, $V_{OUT} = 2.0V$		55	58		dB
		$V_{CC} = 5V$, $V_{EE} = -5V$, $V_{OUT} = 0V$		60	66		
		$V_{CC} = 3.3V$, $V_{EE} = 0V$, $V_{OUT} = 0.90V$			45		
Output Resistance	R_{OUT}	$f = DC$			25		$m\Omega$
Output Current	I_{OUT}	$R_L = 20\Omega$ to V_{CC} or V_{EE}		± 100	± 120		mA
Short-Circuit Output Current	I_{SC}	Sinking or sourcing			± 150		mA
Output Voltage Swing	V_{OUT}	$R_L = 50\Omega$	$V_{CC} - V_{OH}$		1.60	1.90	V
			$V_{OL} - V_{EE}$		0.04	0.075	
		$R_L = 150\Omega$	$V_{CC} - V_{OH}$		0.75	1.00	
			$V_{OL} - V_{EE}$		0.04	0.075	
		$R_L = 2k\Omega$	$V_{CC} - V_{OH}$		0.06		
			$V_{OL} - V_{EE}$		0.06		
Disabled Output Resistance	$R_{OUT(OFF)}$	MAX4215/MAX4219, $EN_- = 0V$, $0V \leq V_{OUT} \leq 5V$			1		$k\Omega$
EN_- Logic Low Threshold	V_{IL}	MAX4215/MAX4219			$V_{CC} - 2.6$		V
EN_- Logic High Threshold	V_{IH}	MAX4215/MAX4219		$V_{CC} - 1.6$			V

High-Speed, Single-Supply, Gain of +2, Closed-Loop, Rail-to-Rail Buffers with Enable

MAX4214/MAX4215/MAX4217/MAX4219/MAX4222

DC ELECTRICAL CHARACTERISTICS (continued)

($V_{CC} = +5V$, $V_{EE} = 0V$, $I_{N-} = 0V$, $E_{N-} = 5V$, $R_L = \infty$ to $0V$, $V_{OUT} = V_{CC}/2$, noninverting configuration, $T_A = T_{MIN}$ to T_{MAX} , unless otherwise noted. Typical values are at $T_A = +25^{\circ}C$.) (Note 1)

PARAMETER	SYMBOL	CONDITIONS	MIN	TYP	MAX	UNITS
EN_ Logic Input Low Current	I_{IL}	MAX4215/MAX4219, $(V_{EE} + 0.2V) \leq E_{N-} \leq V_{CC}$		0.5		μA
		MAX4215/MAX4219, $E_{N-} = V_{EE}$		200	350	
EN_ Logic Input High Current	I_{IH}	MAX4215/MAX4219, $E_{N-} = V_{CC}$		0.5	10	μA
Quiescent Supply Current (per Buffer)	I_{CC}			5.5	7.0	mA
Shutdown Supply Current	I_{SD}	MAX4215/MAX4219, disabled ($E_{N-} = V_{EE}$)		400	550	μA

Note 1: The MAX421_EU_ is 100% production tested at $T_A = +25^{\circ}C$. Specifications over temperature limits are guaranteed by design.

Note 2: PSR for single +5V supply tested with $V_{EE} = 0V$, $V_{CC} = +4.5V$ to $+5.5V$; for dual $\pm 5V$ supply with $V_{EE} = -4.5V$ to $-5.5V$, $V_{CC} = +4.5V$ to $+5.5V$; and for single +3V supply with $V_{EE} = 0V$, $V_{CC} = +3.15V$ to $+3.45V$.

AC ELECTRICAL CHARACTERISTICS

($V_{CC} = +5V$, $V_{EE} = 0V$, $I_{N-} = 0V$, $E_{N-} = 5V$, $R_L = 100\Omega$ to $V_{CC}/2$, noninverting configuration, $T_A = T_{MIN}$ to T_{MAX} , unless otherwise noted. Typical values are at $T_A = +25^{\circ}C$.)

PARAMETER	SYMBOL	CONDITIONS	MIN	TYP	MAX	UNITS
Small-Signal -3dB Bandwidth	BW_{-3dB}	$V_{OUT} = 100mVp-p$		230		MHz
			MAX4214/MAX4215/MAX4217		200	
Full-Power -3dB Bandwidth	FPBW	$V_{OUT} = 2Vp-p$		220		MHz
			MAX4214/MAX4215/MAX4217		200	
Bandwidth for 0.1dB Gain Flatness	$BW_{0.1dB}$	$V_{OUT} = 100mVp-p$		50		MHz
			MAX4214/MAX4215/MAX4217		90	
Slew Rate	SR	$V_{OUT} = 2V$ step		600		V/ μs
Settling Time to 0.1%	t_S	$V_{OUT} = 2V$ step		45		ns
Rise/Fall Time	t_R, t_F	$V_{OUT} = 100mVp-p$		1		ns
Spurious-Free Dynamic Range	SFDR	$f_C = 5MHz$, $V_{OUT} = 2Vp-p$		-72		dBc
Harmonic Distortion	HD	$V_{OUT} = 2Vp-p$, $f_C = 5MHz$	Second harmonic		-72	dBc
			Third harmonic		-77	
			Total harmonic distortion		-71	
Third-Order Intercept	IP3	$f = 10MHz$		35		dBm
Input 1dB Compression Point		$f = 10MHz$		11		dBm
Differential Phase Error	DP	NTSC, $R_L = 150\Omega$		0.04		degrees
Differential Gain Error	DG	NTSC, $R_L = 150\Omega$		0.03		%
Input Noise-Voltage Density	e_n	$f = 10kHz$		10		nV/\sqrt{Hz}
Input Noise-Current Density	i_n	$f = 10kHz$		1.3		pA/\sqrt{Hz}
Input Capacitance	C_{IN}			1		pF
Disabled Output Capacitance	$C_{OUT(OFF)}$	MAX4215/MAX4219, $E_{N-} = 0V$		2		pF

High-Speed, Single-Supply, Gain of +2, Closed-Loop, Rail-to-Rail Buffers with Enable

AC ELECTRICAL CHARACTERISTICS (continued)

($V_{CC} = +5V$, $V_{EE} = 0V$, $IN_{-} = 0V$, $EN_{-} = 5V$, $R_L = 100\Omega$ to $V_{CC}/2$, noninverting configuration, $T_A = T_{MIN}$ to T_{MAX} , unless otherwise noted. Typical values are at $T_A = +25^{\circ}C$.)

PARAMETER	SYMBOL	CONDITIONS	MIN	TYP	MAX	UNITS
Output Impedance	Z_{OUT}	$f = 10MHz$		200		$m\Omega$
Buffer Enable Time	t_{ON}	MAX4215/MAX4219		100		ns
Buffer Disable Time	t_{OFF}	MAX4215/MAX4219		1		μs
Buffer Gain Matching		MAX4217/MAX4219/MAX4222, $f = 10MHz$, $V_{OUT} = 100mVp-p$		0.1		dB
All-Hostile Crosstalk	X_{TALK}	MAX4217/MAX4219/MAX4222, $f = 10MHz$, $V_{OUT} = 2Vp-p$		-95		dB

Note 2: PSR for single +5V supply tested with $V_{EE} = 0V$, $V_{CC} = +4.5V$ to $+5.5V$; for dual $\pm 5V$ supply with $V_{EE} = -4.5V$ to $-5.5V$, $V_{CC} = +4.5V$ to $+5.5V$; and for single +3V supply with $V_{EE} = 0V$, $V_{CC} = +3.15V$ to $+3.45V$.

Typical Operating Characteristics

($V_{CC} = +5V$, $V_{EE} = 0V$, $A_{VCL} = +2V/V$, $R_L = 100\Omega$ to $V_{CC}/2$, $T_A = +25^{\circ}C$, unless otherwise noted.)

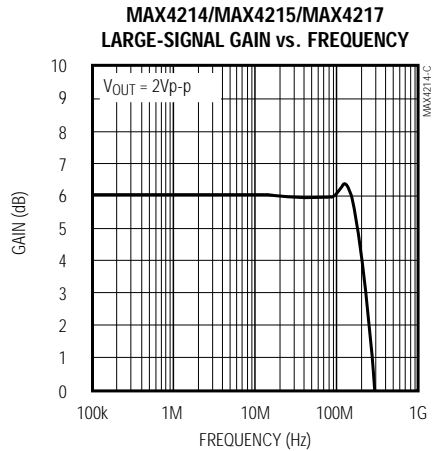
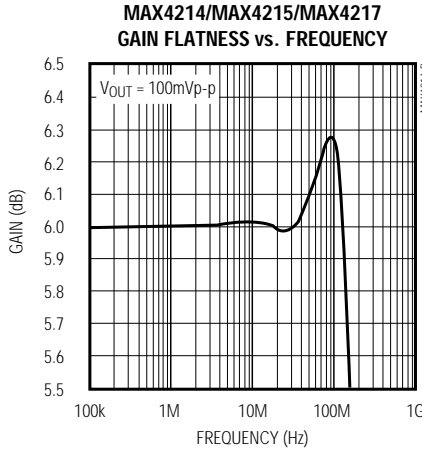
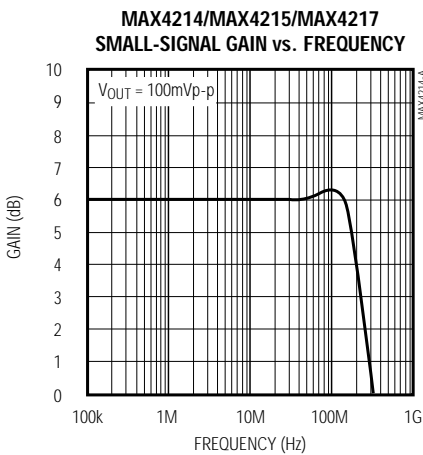

High-Speed, Single-Supply, Gain of +2, Closed-Loop, Rail-to-Rail Buffers with Enable

Typical Operating Characteristics (continued)

($V_{CC} = +5V$, $V_{EE} = 0V$, $A_{VCL} = +2V/V$, $R_L = 100\Omega$ to $V_{CC}/2$, $T_A = +25^\circ C$, unless otherwise noted.)

MAX4214/MAX4215/MAX4217/MAX4219/MAX4222

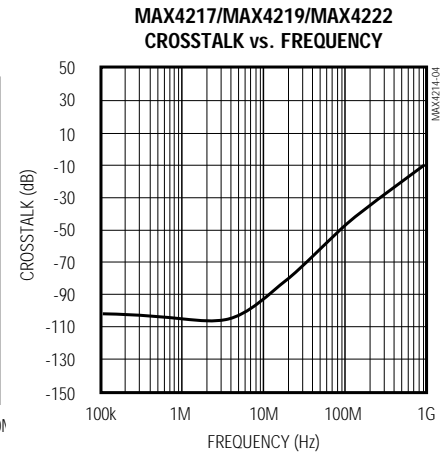
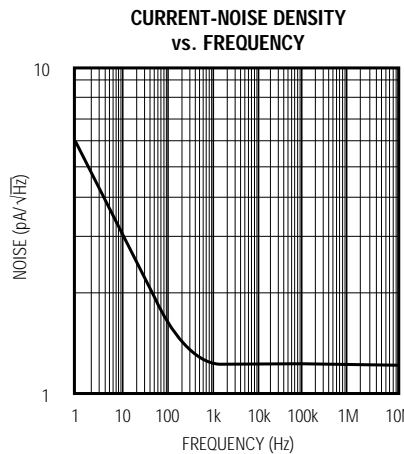
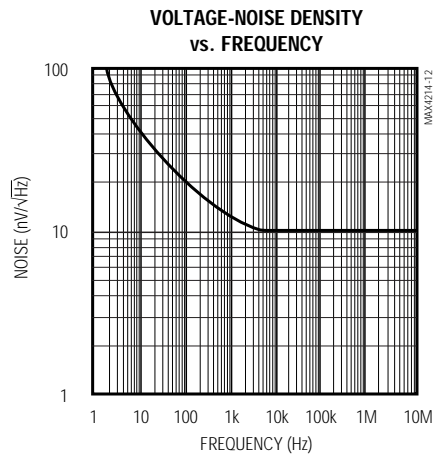
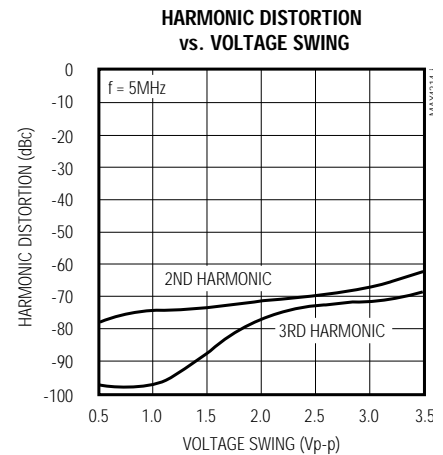
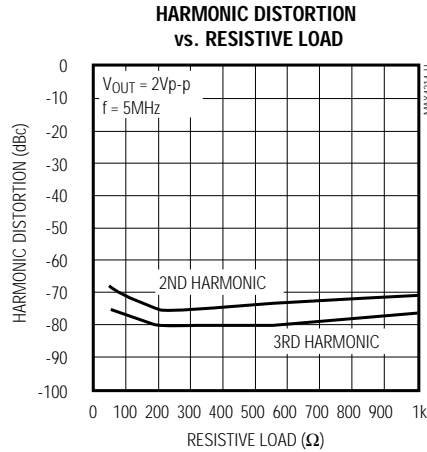
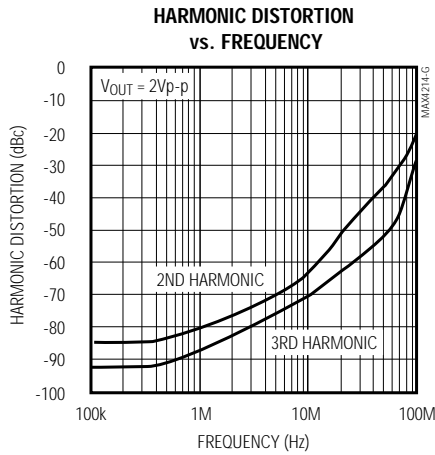
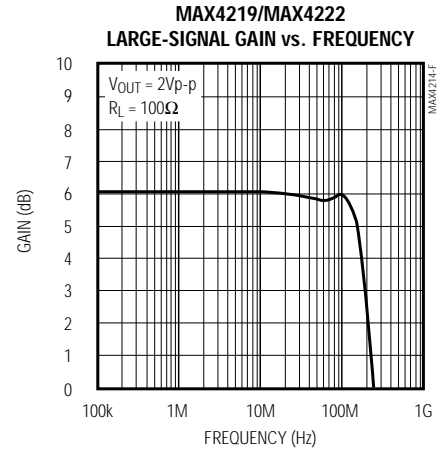
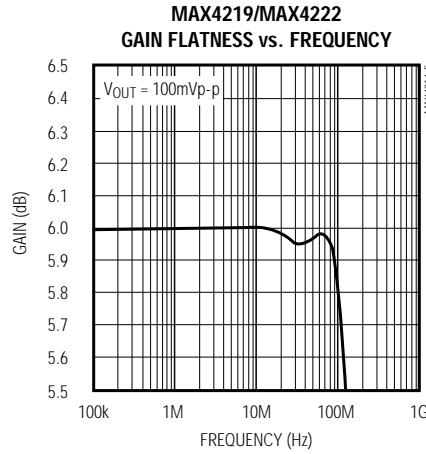
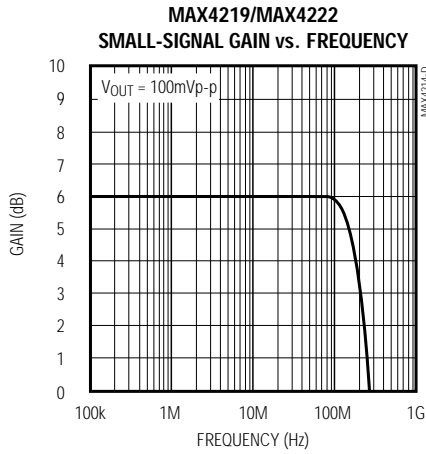

High-Speed, Single-Supply, Gain of +2, Closed-Loop, Rail-to-Rail Buffers with Enable

Typical Operating Characteristics (continued)

($V_{CC} = +5V$, $V_{EE} = 0V$, $A_{VCL} = +2V/V$, $R_L = 100\Omega$ to $V_{CC}/2$, $T_A = +25^\circ C$, unless otherwise noted.)

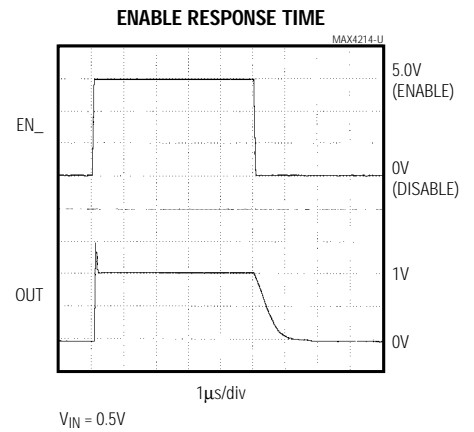
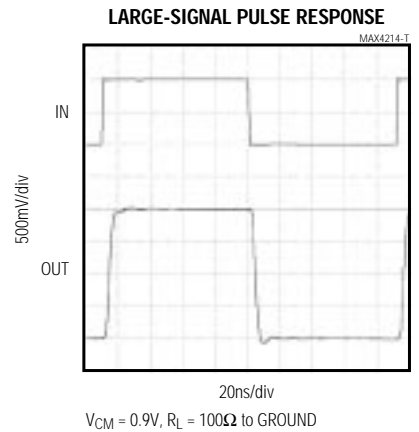
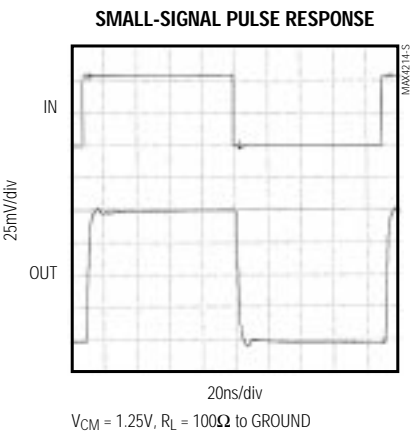
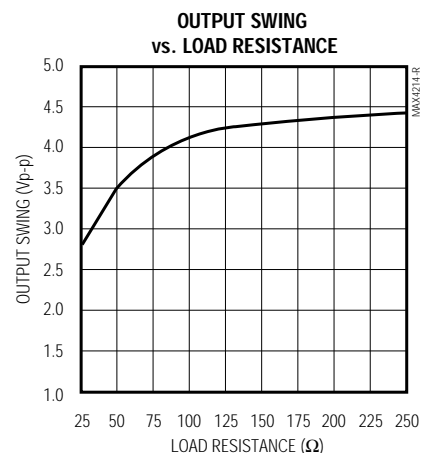
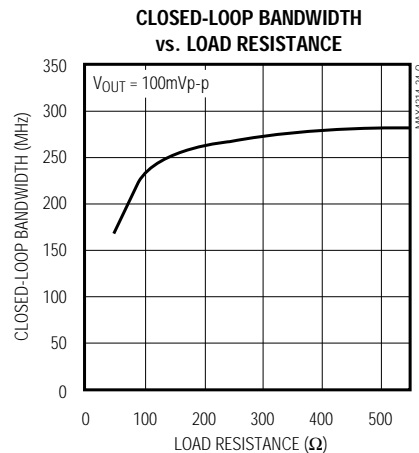
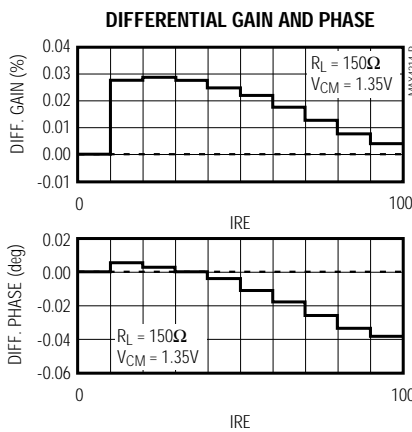
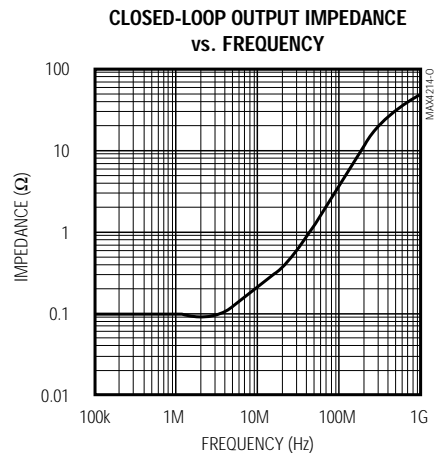
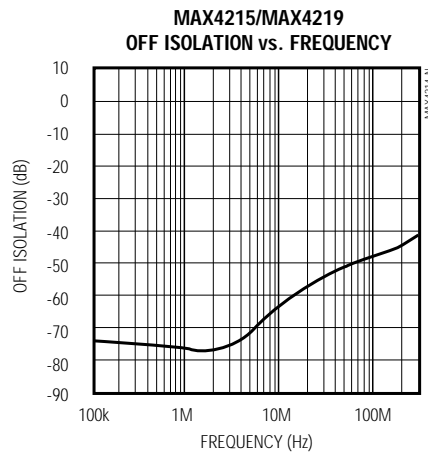
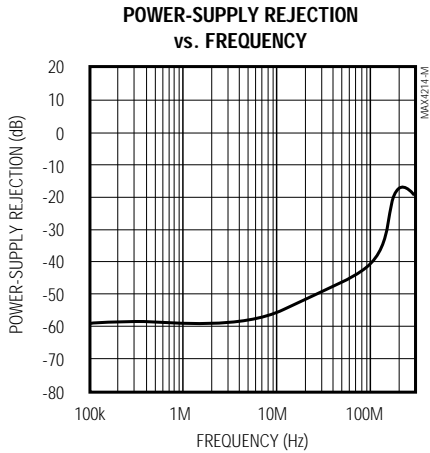

High-Speed, Single-Supply, Gain of +2, Closed-Loop, Rail-to-Rail Buffers with Enable

Typical Operating Characteristics (continued)

($V_{CC} = +5V$, $V_{EE} = 0V$, $A_{vCL} = +2V/V$, $R_L = 100\Omega$ to $V_{CC}/2$, $T_A = +25^\circ C$, unless otherwise noted.)

SMALL-SIGNAL PULSE RESPONSE
($C_L = 5pF$)

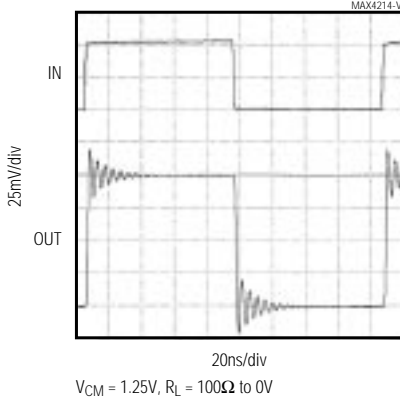

LARGE-SIGNAL PULSE RESPONSE
($C_L = 5pF$)

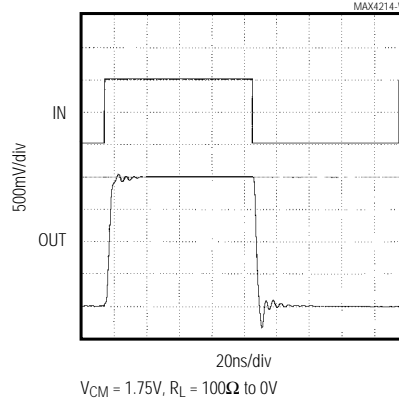

VOLTAGE SWING vs. TEMPERATURE

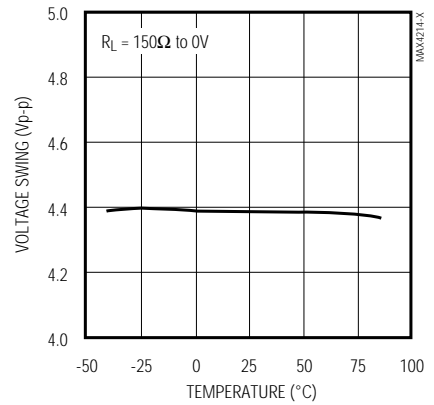

INPUT OFFSET VOLTAGE vs. TEMPERATURE

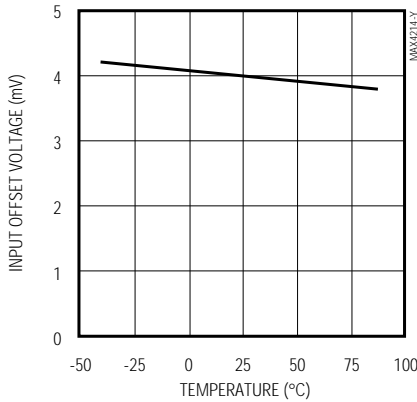

INPUT BIAS CURRENT vs. TEMPERATURE

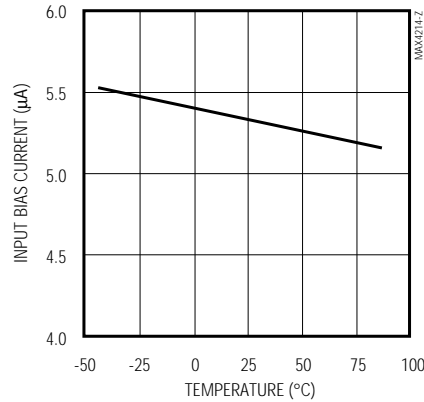

INPUT OFFSET CURRENT vs. TEMPERATURE

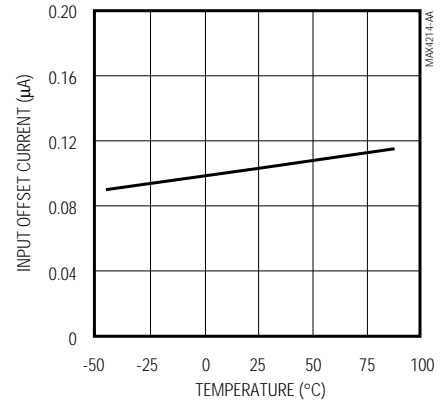

POWER-SUPPLY CURRENT (PER AMPLIFIER) vs. POWER-SUPPLY VOLTAGE

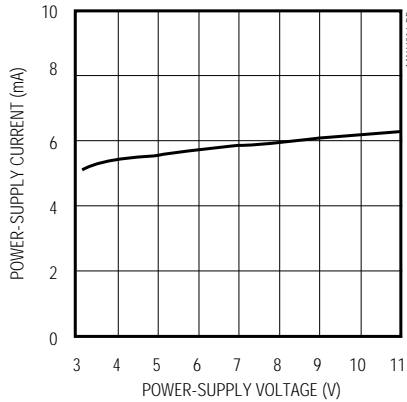

POWER-SUPPLY CURRENT (PER AMPLIFIER) vs. TEMPERATURE

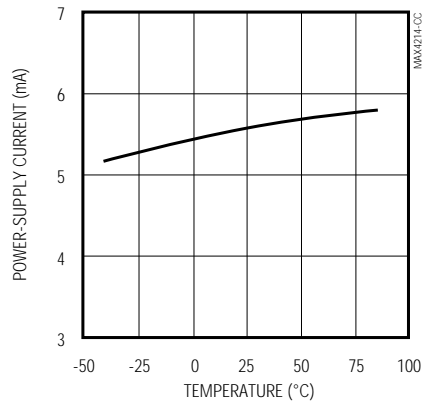

MAX4214/MAX4215/MAX4217/MAX4219/MAX4222

High-Speed, Single-Supply, Gain of +2, Closed-Loop, Rail-to-Rail Buffers with Enable

Pin Description

PIN							NAME	FUNCTION
MAX4214 SOT23-5	MAX4215 SO/ μ MAX	MAX4217 SO/ μ MAX	MAX4219 SO QSOP		MAX4222 SO QSOP			
—	1, 5	—	—	8, 9	—	8, 9	N.C.	No Connect. Not internally connected. Tie to ground or leave open.
1	6	—	—	—	—	—	OUT	Amplifier Output
2	4	4	11	13	11	13	V _{EE}	Negative Power Supply or Ground (in single-supply operation)
3	3	—	—	—	—	—	IN+	Noninverting Input
4	2	—	—	—	—	—	IN-	Inverting Input
5	7	8	4	4	4	4	V _{CC}	Positive Power Supply
—	8	—	—	—	—	—	EN	Enable Amplifier
—	—	—	1	1	—	—	ENA	Enable Amplifier A
—	—	—	3	3	—	—	ENB	Enable Amplifier B
—	—	—	2	2	—	—	ENC	Enable Amplifier C
—	—	1	7	7	1	1	OUTA	Amplifier A Output
—	—	2	6	6	2	2	INA-	Amplifier A Inverting Input
—	—	3	5	5	3	3	INA+	Amplifier A Noninverting Input
—	—	7	8	10	7	7	OUTB	Amplifier B Output
—	—	6	9	11	6	6	INB-	Amplifier B Inverting Input
—	—	5	10	12	5	5	INB+	Amplifier B Noninverting Input
—	—	—	14	16	8	10	OUTC	Amplifier C Output
—	—	—	13	15	9	11	INC-	Amplifier C Inverting Input
—	—	—	12	14	10	12	INC+	Amplifier C Noninverting Input
—	—	—	—	—	14	16	OUTD	Amplifier D Output
—	—	—	—	—	13	15	IND-	Amplifier D Inverting Input
—	—	—	—	—	12	14	IND+	Amplifier D Noninverting Input

MAX4214/MAX4215/MAX4217/MAX4219/MAX4222

High-Speed, Single-Supply, Gain of +2, Closed-Loop, Rail-to-Rail Buffers with Enable

MAX4214/MAX4215/MAX4217/MAX4219/MAX4222

Detailed Description

The MAX4214/MAX4215/MAX4217/MAX4219/MAX4222 are single-supply, rail-to-rail output, voltage-feedback, closed-loop buffers that employ current-feedback techniques to achieve 600V/ μ s slew rates and 230MHz bandwidths. These buffers use internal 500 Ω resistors to provide a preset closed-loop gain of +2V/V in the noninverting configuration or -1V/V in the inverting configuration. Excellent harmonic distortion and differential gain/phase performance make them an ideal choice for a wide variety of video and RF signal-processing applications.

Local feedback around the buffer's output stage ensures low output impedance, which reduces gain sensitivity to load variations. This feedback also produces demand-driven current bias to the output transistors for \pm 120mA drive capability, while constraining total supply current to less than 7mA.

Applications Information

Power Supplies

These devices operate from a single +3.15V to +11V power supply or from dual supplies of \pm 1.575V to \pm 5.5V. For single-supply operation, bypass the V_{CC} pin to ground with a 0.1 μ F capacitor as close to the pin as possible. If operating with dual supplies, bypass each supply with a 0.1 μ F capacitor.

Selecting Gain Configuration

Each buffer in the MAX4214 family can be configured for a voltage gain of +2V/V or -1V/V. For a gain of +2V/V, ground the inverting terminal. Use the noninverting terminal as the signal input of the buffer (Figure 1a). Grounding the noninverting terminal and using the inverting terminal as the signal input configures the buffer for a gain of -1V/V (Figure 1b).

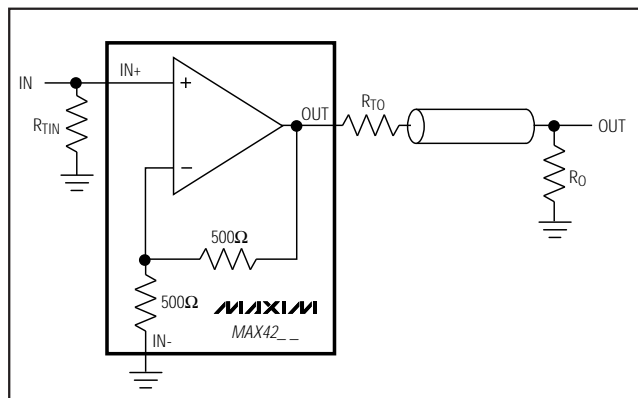

Figure 1a. Noninverting Gain Configuration ($A_V = +2V/V$)

Since the inverting input exhibits a 500 Ω input impedance, terminate the input with a 56 Ω resistor when configured for an inverting gain in 50 Ω applications (terminate with 88 Ω in 75 Ω applications). Terminate the input with a 49.9 Ω resistor in the noninverting case. Output terminating resistors should directly match cable impedances in either configuration.

Layout Techniques

Maxim recommends using microstrip and stripline techniques to obtain full bandwidth. To ensure the PC board does not degrade the buffer's performance, design it for a frequency greater than 1GHz. Pay careful attention to inputs and outputs to avoid large parasitic capacitance. Whether or not you use a constant-impedance board, observe the following guidelines when designing the board:

- Don't use wire-wrapped boards. They are too inductive.
- Don't use IC sockets. They increase parasitic capacitance and inductance.
- Use surface-mount instead of through-hole components for better high-frequency performance.
- Use a PC board with at least two layers; it should be as free from voids as possible.
- Keep signal lines as short and as straight as possible. Do not make 90° turns; round all corners.

Input Voltage Range and Output Swing

The MAX4214 family's input range extends from (V_{EE} - 100mV) to (V_{CC} - 2.25V). Input ground sensing increases the dynamic range for single-supply applications. The outputs drive a 2k Ω load to within 60mV of the power-supply rails. With smaller resistive loads, the output swing is reduced as shown in the *Electrical Characteristics* and *Typical Operating Characteristics*.

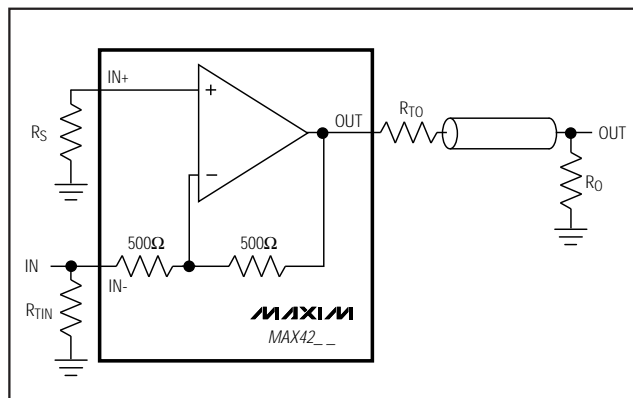

Figure 1b. Inverting Gain Configuration ($A_V = -1V/V$)

High-Speed, Single-Supply, Gain of +2, Closed-Loop, Rail-to-Rail Buffers with Enable

As the load resistance decreases, the useful input range is effectively limited by the output drive capability, since the buffers have a fixed voltage gain of +2V/V or -1V/V.

For example, a 50Ω load can typically be driven from 40mV above V_{EE} to 1.6V below V_{CC}, or 40mV to 3.4V when operating from a single +5V supply. If the buffer is operated in the noninverting, gain of +2V/V configuration with the inverting input grounded, the useful input voltage range becomes 20mV to 1.7V instead of the -100mV to 2.75V indicated by the *Electrical Characteristics*. Beyond the useful input range, the buffer output is a nonlinear function of the input, but it will not undergo phase reversal or latchup.

Enable

The MAX4215 and MAX4219 have an enable feature (EN₋) that allows the buffer to be placed in a low-power state. When the buffers are disabled, the supply current is reduced to 400μA per buffer.

As the voltage at the EN₋ pin approaches the negative supply rail, the EN₋ input current rises. Figure 2 shows a graph of EN₋ input current versus EN₋ pin voltage. Figure 3 shows the addition of an optional resistor in series with the EN pin, to limit the magnitude of the current increase. Figure 4 displays the resulting EN pin input current to voltage relationship.

Disabled Output Resistance

The MAX4214/MAX4215/MAX4217/MAX4219/MAX4222 include internal protection circuitry that prevents damage to the precision input stage from large differential input voltages (Figure 5). This protection circuitry con-

sists of five back-to-back Schottky diodes between IN₋ and IN₊. These diodes reduce the disabled output resistance from 1kΩ to 500Ω when the output voltage is 3V greater or less than the voltage at IN₊. Under these conditions, the input protection diodes will be forward biased, lowering the disabled output resistance to 500Ω.

Output Capacitive Loading and Stability

The MAX4214 family provides maximum AC performance with no load capacitance. This is the case when the load is a properly terminated transmission line. These devices are designed to drive up to 20pF of load capacitance without oscillating, but AC performance will be reduced under these conditions.

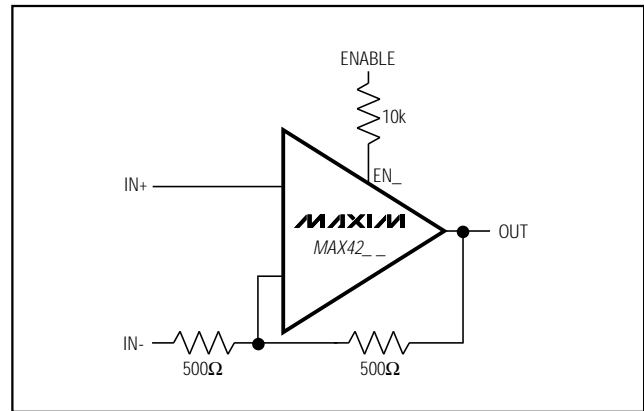

Figure 3. Circuit to Reduce Enable Logic-Low Input Current

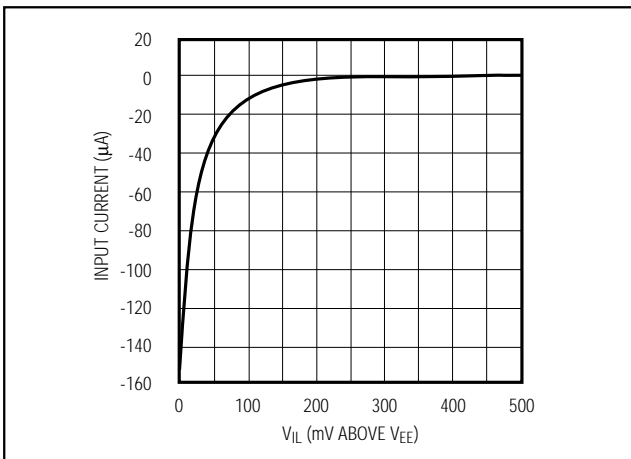

Figure 2. Enable Logic-Low Input Current vs. Enable Logic-Low Threshold

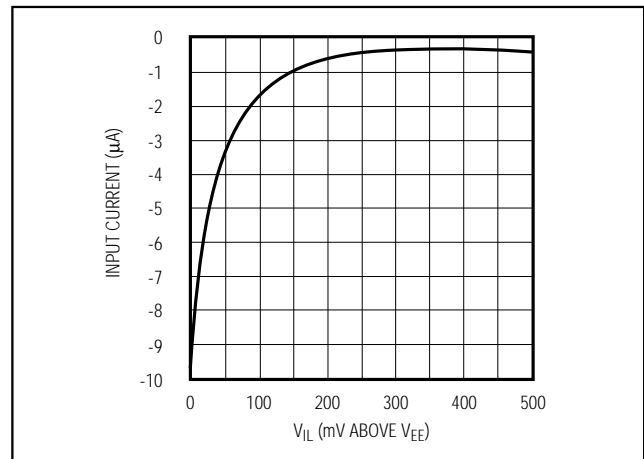

Figure 4. Enable Logic-Low Input Current vs. Enable Logic-Low Threshold with 10kΩ Series Resistor

High-Speed, Single-Supply, Gain of +2, Closed-Loop, Rail-to-Rail Buffers with Enable

MAX4214/MAX4215/MAX4217/MAX4219/MAX4222

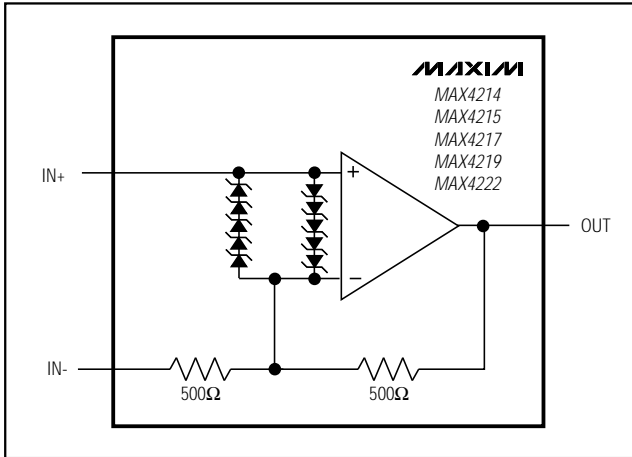

Figure 5. Input Protection Circuit

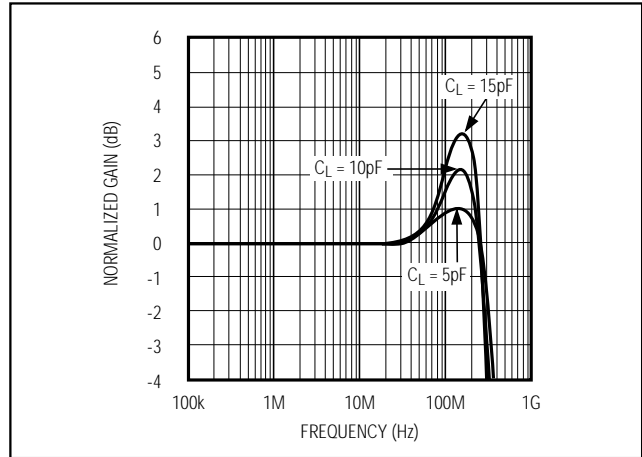

Figure 6. Small-Signal Gain vs. Frequency with Load Capacitance and No Isolation Resistor

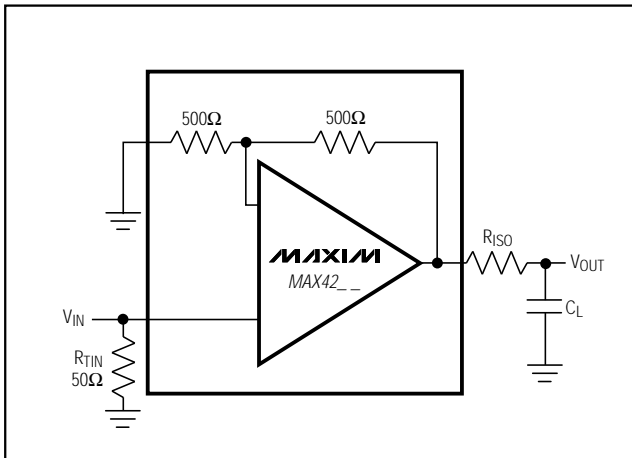

Figure 7. Driving a Capacitive Load Through an Isolation Resistor

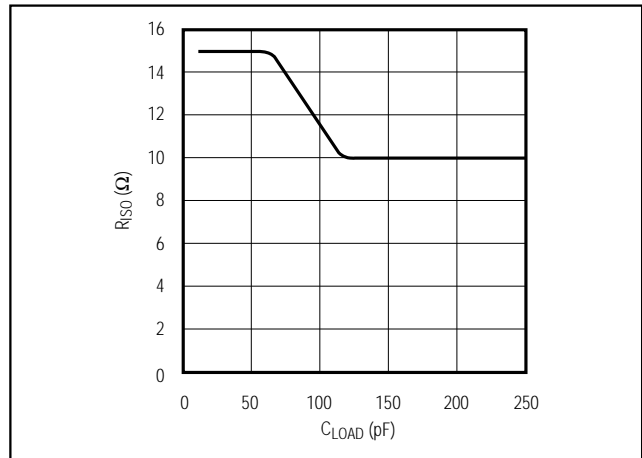

Figure 8. Isolation Resistance vs. Capacitive Load

Driving large capacitive loads increases the chance of oscillations occurring in most amplifier circuits. This is especially true for circuits with high loop gains, such as voltage followers. The buffer's output resistance and the load capacitor combine to add a pole and excess phase to the loop response. If the frequency of this pole is low enough to interfere with the loop response and degrade phase margin sufficiently, oscillations can occur.

A second problem when driving capacitive loads results from the amplifier's output impedance, which looks inductive at high frequencies. This inductance forms an L-C resonant circuit with the capacitive load, which causes peaking in the frequency response and degrades the amplifier's gain margin.

Figure 6 shows the devices' frequency response under different capacitive loads. To drive loads with greater than 20pF of capacitance or to settle out some of the peaking, the output requires an isolation resistor like the one shown in Figure 7. Figure 8 is a graph of the optimal isolation resistor versus load capacitance. Figure 9 shows the frequency response of the MAX4214/MAX4215/MAX4217/MAX4219/MAX4222 when driving capacitive loads with a 27Ω isolation resistor.

Coaxial cables and other transmission lines are easily driven when properly terminated at both ends with their characteristic impedance. Driving back-terminated transmission lines essentially eliminates the lines' capacitance.

High-Speed, Single-Supply, Gain of +2, Closed-Loop, Rail-to-Rail Buffers with Enable

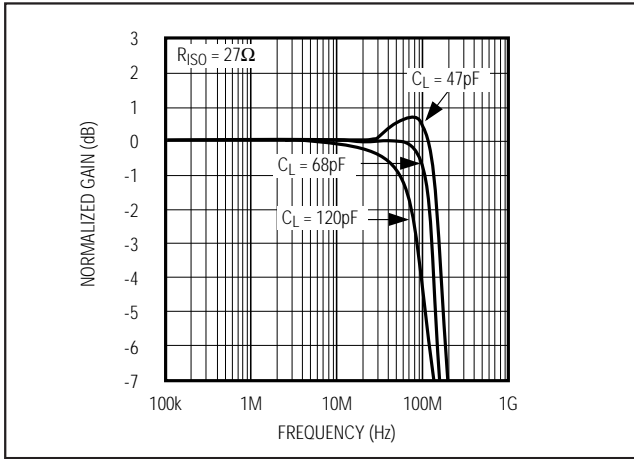
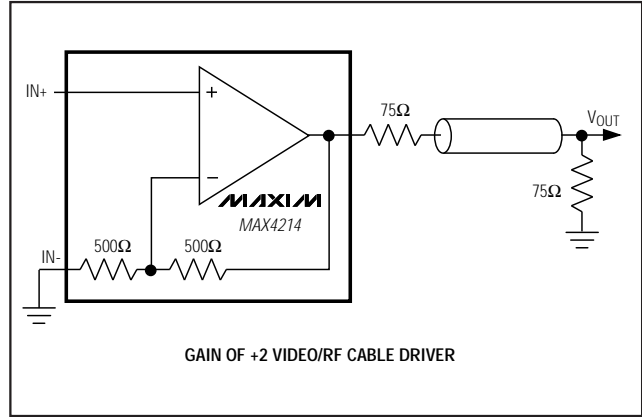

Figure 9. Small-Signal Gain vs. Frequency with Load Capacitance and 27Ω Isolation Resistor

Typical Application Circuit



Chip Information

PART	NO. OF TRANSISTORS
MAX4214	95
MAX4215	95
MAX4217	190
MAX4219	299
MAX4222	362

SUBSTRATE CONNECTED TO V_{EE}

High-Speed, Single-Supply, Gain of +2, Closed-Loop, Rail-to-Rail Buffers with Enable

Pin Configurations (continued)

MAX4214/MAX4215/MAX4217/MAX4219/MAX4221/MAX4222

TOP VIEW

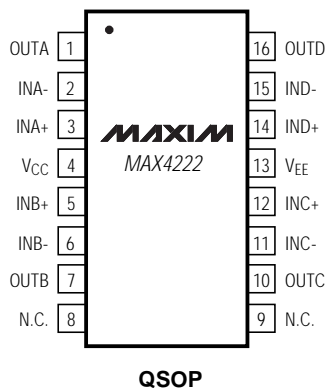
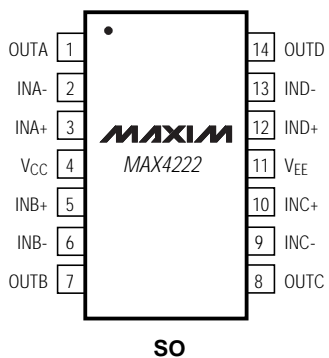
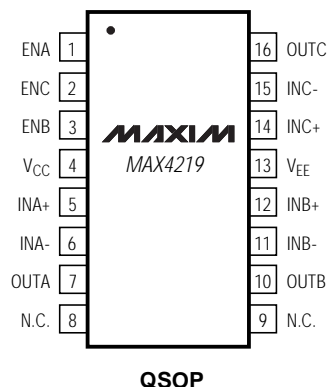
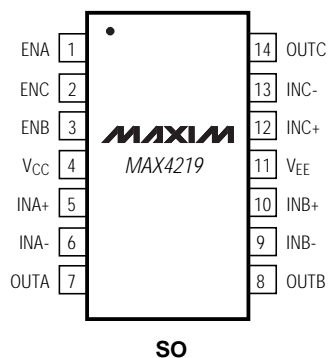
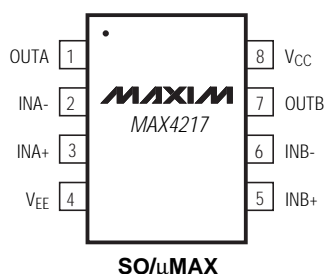
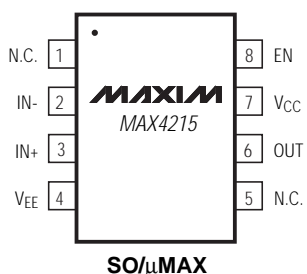

High-Speed, Single-Supply, Gain of +2, Closed-Loop, Rail-to-Rail Buffers with Enable

Tape-and-Reel Information

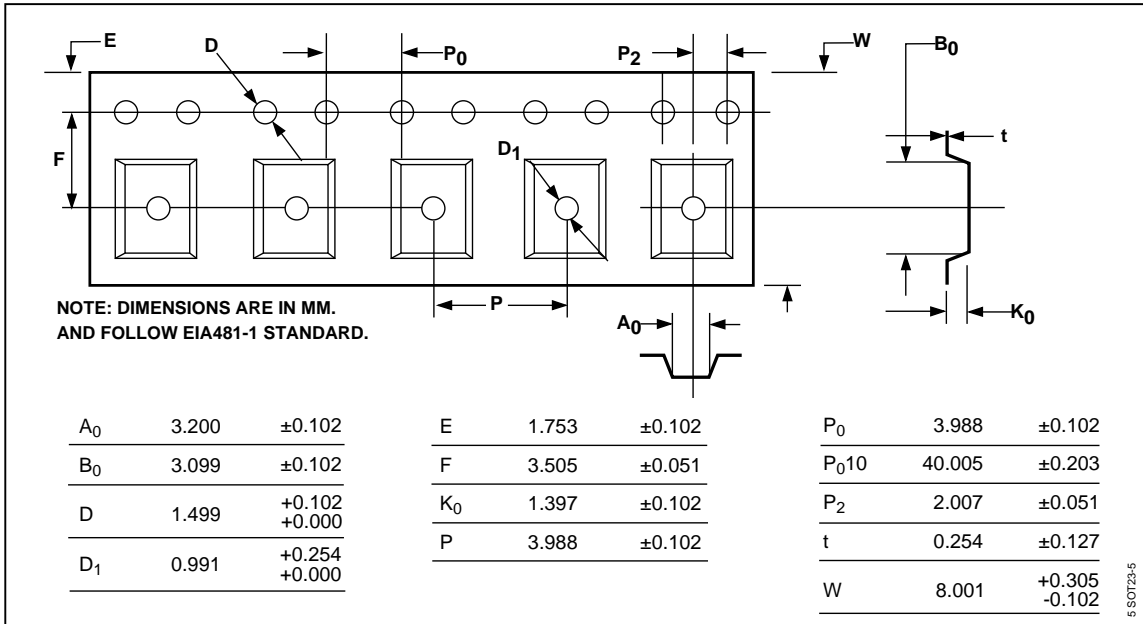

Package Information

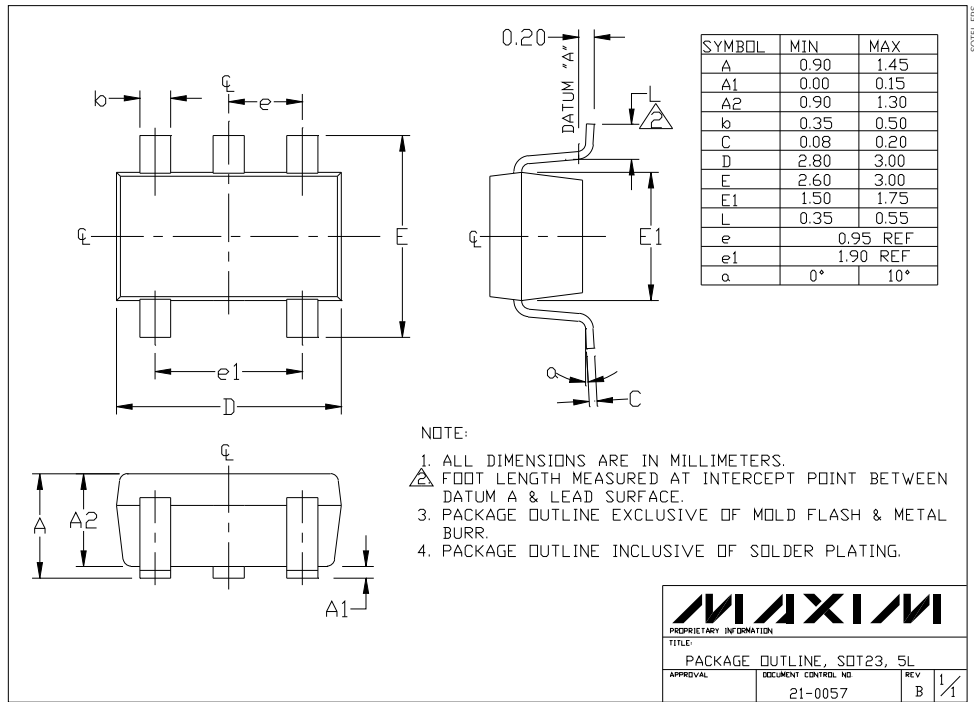

High-Speed, Single-Supply, Gain of +2, Closed-Loop, Rail-to-Rail Buffers with Enable

Package Information (continued)

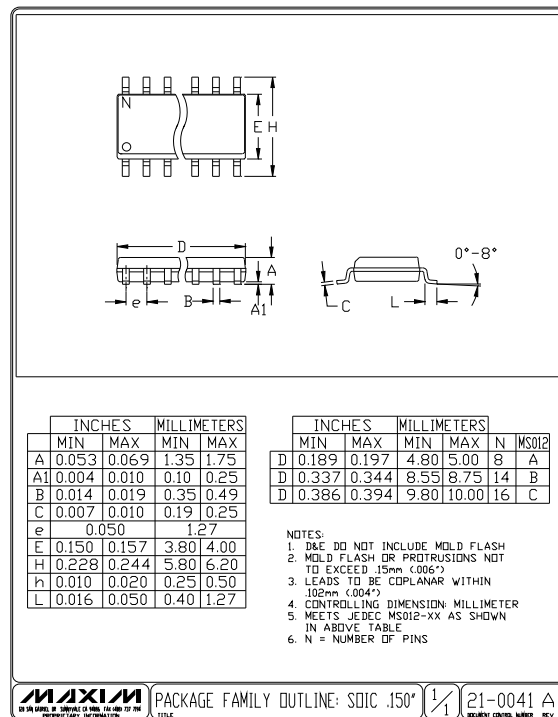
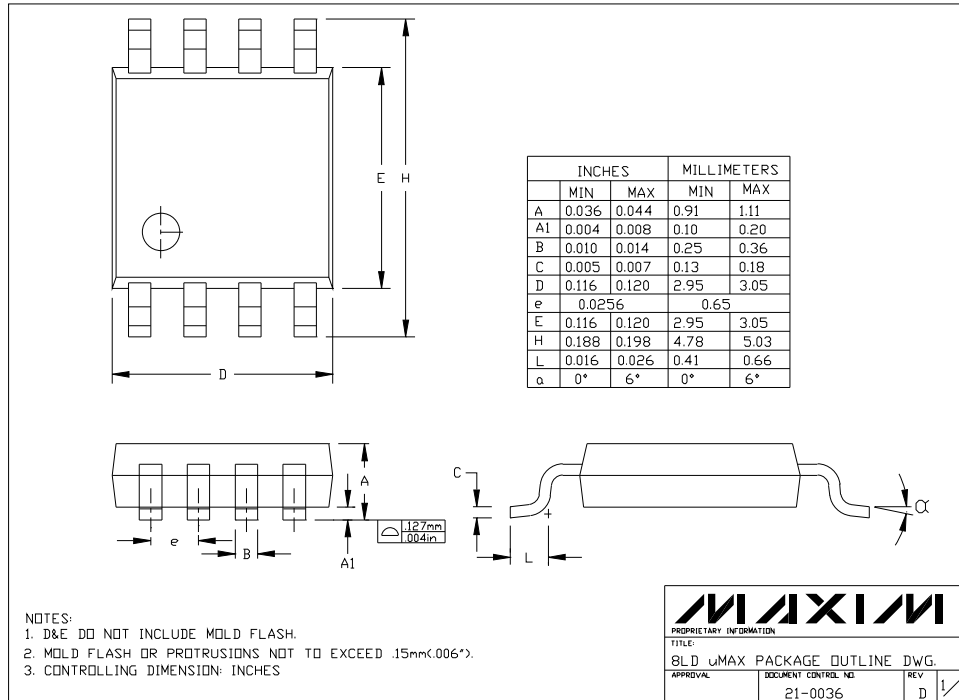

MAX4214/MAX4215/MAX4217/MAX4219/MAX4222

High-Speed, Single-Supply, Gain of +2, Closed-Loop, Rail-to-Rail Buffers with Enable

Package Information (continued)

DIM	INCHES		MILLIMETERS	
	MIN	MAX	MIN	MAX
A	.061	.068	1.55	1.73
A1	.004	.0098	0.127	0.25
A2	.055	.061	1.40	1.55
B	.008	.012	0.20	0.31
C	.0075	.0098	0.19	0.25
D	SEE VARIATIONS			
E	.150	.157	3.81	3.99
e	.025 BSC		0.635 BSC	
H	.230	.244	5.84	6.20
h	.010	.016	0.25	0.41
L	.016	.035	0.41	0.89
N	SEE VARIATIONS			
S	SEE VARIATIONS			
?	0°	8°	0°	8°

DIM	INCHES		MILLIMETERS		N
	MIN.	MAX.	MIN.	MAX.	
D	.189	.196	4.80	4.98	16
S	.0020	.0070	0.05	0.18	
D	.337	.344	8.56	8.74	20
S	.0500	.0550	1.27	1.40	
D	.337	.344	8.56	8.74	24
S	.0250	.0300	0.64	0.76	
D	.386	.393	9.80	9.98	28
S	.0250	.0300	0.64	0.76	

NOTES:

- D & E DO NOT INCLUDE MOLD FLASH OR PROTRUSIONS
- MOLD FLASH OR PROTRUSIONS NOT TO EXCEED .006"
- CONTROLLING DIMENSIONS: INCHES

MAXIM
PROPRIETARY INFORMATION
 TITLE:
 PACKAGE OUTLINE, QSDP, .150 INCH, .025" LEAD PITCH
 APPROVAL: _____ DOCUMENT CONTROL NO: 21-0055 REV: A 1/1

QSDP/EP

Maxim cannot assume responsibility for use of any circuitry other than circuitry entirely embodied in a Maxim product. No circuit patent licenses are implied. Maxim reserves the right to change the circuitry and specifications without notice at any time.

16 Maxim Integrated Products, 120 San Gabriel Drive, Sunnyvale, CA 94086 408-737-7600