



# Ultra-Low-Distortion, Single-Supply, 300MHz Op Amps with Enable

## General Description

The MAX4265–MAX4270 single-supply, voltage-feedback op amps are capable of driving a 100Ω load while maintaining ultra-low distortion over a wide bandwidth. They offer superior spurious-free dynamic range (SFDR) performance: -90dBc or better at frequencies below 5MHz and -60dBc at a 100MHz frequency. Additionally, input voltage noise density is 8nV/√Hz while operating from a single +4.5V to +8.0V supply or from dual ±2.25V to ±4.0V supplies. These features make the MAX4265–MAX4270 ideal for use in high-performance communications and signal-processing applications that require low distortion and wide bandwidth.

The MAX4265 single and MAX4268 dual unity-gain-stable amplifiers have up to a 300MHz gain-bandwidth product. The MAX4266 single and MAX4269 dual amplifiers have up to a 350MHz bandwidth at a minimum stable gain of +2V/V. The MAX4267 single and MAX4270 dual amplifiers have a 200MHz bandwidth at a minimum stable gain of +5V/V.

For additional power savings, these amplifiers feature a low-power disable mode that reduces supply current to 1.6mA and places the outputs in a high-impedance state. The MAX4265/MAX4266/MAX4267 are available in a space-saving 8-pin μMAX package, and the MAX4268/MAX4269/MAX4270 are available in a 16-pin QSOP package.

## Applications

Base-Station Amplifiers  
 IF Amplifiers  
 High-Frequency ADC Drivers  
 High-Speed DAC Buffers  
 RF Telecom Applications  
 High-Frequency Signal Processing

Pin Configurations appear at end of data sheet.

## Selector Guide

PART	NO. OF OP AMPS	MIN GAIN (V/V)	BANDWIDTH (MHz)
MAX4265	1	1	300
MAX4266	1	2	350
MAX4267	1	5	200
MAX4268	2	1	300
MAX4269	2	2	350
MAX4270	2	5	200

## Features

- ◆ +4.5V to +8.0V Single-Supply Operation
- ◆ Superior SFDR with 100Ω Load
  - 90dBc ( $f_c = 5\text{MHz}$ )
  - 60dBc ( $f_c = 100\text{MHz}$ )
- ◆ 35dBm IP3 ( $f_c = 20\text{MHz}$ )
- ◆ 8nV/√Hz Voltage Noise Density
- ◆ 100MHz 0.1dB Gain Flatness (MAX4268)
- ◆ 900V/μs Slew Rate
- ◆ ±45mA Output Driving Capability
- ◆ Shutdown Mode Places Outputs in High-Impedance State

## Ordering Information

PART	TEMP. RANGE	PIN-PACKAGE
MAX4265EUA*	-40°C to +85°C	8 μMAX
MAX4265ESA*	-40°C to +85°C	8 SO
MAX4266EUA*	-40°C to +85°C	8 μMAX
MAX4266ESA*	-40°C to +85°C	8 SO
MAX4267EUA*	-40°C to +85°C	8 μMAX
MAX4267ESA*	-40°C to +85°C	8 SO
MAX4268EEE	-40°C to +85°C	16 QSOP
MAX4268ESD	-40°C to +85°C	14 SO
MAX4269EEE	-40°C to +85°C	16 QSOP
MAX4269ESD	-40°C to +85°C	14 SO
MAX4270EEE	-40°C to +85°C	16 QSOP
MAX4270ESD	-40°C to +85°C	14 SO

\*Future product—contact factory for availability.

## SFDR vs. Input Frequency

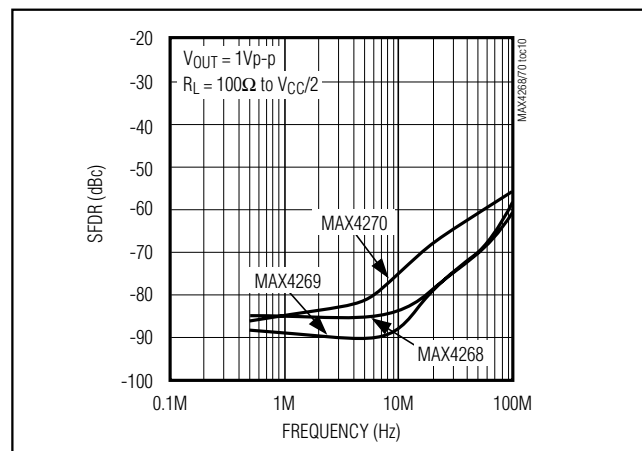

# Ultra-Low-Distortion, Single-Supply, 300MHz Op Amps with Enable

## ABSOLUTE MAXIMUM RATINGS

Supply Voltage ( $V_{CC}$  to  $V_{EE}$ ) ..... +8.5V  
 Voltage on Any Other Pin ..... ( $V_{EE} - 0.3V$ ) to ( $V_{CC} + 0.3V$ )  
 Short-Circuit Duration ( $V_{OUT}$  to  $V_{CC}$  or  $V_{EE}$ ) ..... Continuous  
 Continuous Power Dissipation ( $T_A = +70^\circ\text{C}$ )  
   16-Pin QSOP (derate 8.33mW/ $^\circ\text{C}$  above  $+70^\circ\text{C}$ ) ..... 667mW  
   8-Pin  $\mu\text{MAX}$  (derate 4.10mW/ $^\circ\text{C}$  above  $+70^\circ\text{C}$ ) ..... 330mW  
   8-Pin SO (derate 5.9mW/ $^\circ\text{C}$  above  $+70^\circ\text{C}$ ) ..... 471mW  
   14-Pin SO (derate 8.33mW/ $^\circ\text{C}$  above  $+70^\circ\text{C}$ ) ..... 667mW

Operating Temperature Range .....  $-40^\circ\text{C}$  to  $+85^\circ\text{C}$   
 Storage Temperature Range .....  $-65^\circ\text{C}$  to  $+150^\circ\text{C}$   
 Junction Temperature .....  $+150^\circ\text{C}$   
 Lead Temperature (soldering, 10s) .....  $+300^\circ\text{C}$

Stresses beyond those listed under "Absolute Maximum Ratings" may cause permanent damage to the device. These are stress ratings only, and functional operation of the device at these or any other conditions beyond those indicated in the operational sections of the specifications is not implied. Exposure to absolute maximum rating conditions for extended periods may affect device reliability.

## DC ELECTRICAL CHARACTERISTICS

( $V_{CC} = +5V$ ,  $V_{EE} = 0$ ,  $R_L = 100\Omega$  to  $V_{CC}/2$ ,  $V_{CM} = V_{CC}/2$ ,  $T_A = T_{MIN}$  to  $T_{MAX}$ , typical values are at  $T_A = +25^\circ\text{C}$ , unless otherwise noted.)

PARAMETER	SYMBOL	CONDITIONS	MIN	TYP	MAX	UNITS
Operating Supply Voltage Range	$V_{CC}$	Inferred from PSRR test	4.5		8.0	V
Common-Mode Input Voltage	$V_{CM}$	Inferred from CMRR test	$V_{EE} + 1.6$		$V_{CC} - 1.6$	V
Input Offset Voltage	$V_{OS}$			1	9	mV
Input Offset Voltage Drift	$TCV_{OS}$			1.5		$\mu\text{V}/^\circ\text{C}$
Input Offset Voltage Channel Matching		MAX4268/MAX4269/MAX4270		1		mV
Input Bias Current	$I_B$			3.5	40	$\mu\text{A}$
Input Offset Current	$I_{OS}$			0.1	5.5	$\mu\text{A}$
Common-Mode Input Resistance	$R_{INCM}$	Either input, $(V_{EE} + 1.6) \leq V_{CM} \leq (V_{CC} - 1.6)$		1		$\text{M}\Omega$
Differential Input Resistance	$R_{INDIFF}$	$-10\text{mV} \leq V_{IN} \leq 10\text{mV}$		40		$\text{k}\Omega$
Common-Mode Rejection Ratio	CMRR	$(V_{EE} + 1.6V) \leq V_{CM} \leq (V_{CC} - 1.6V)$ , no load	60	85		dB
Power-Supply Rejection Ratio	PSRR	$V_{CC} = 4.5V$ to $8.0V$	60	85		dB
Open-Loop Voltage Gain	$A_{OL}$	$1.75V \leq V_{OUT} \leq 3.25V$	60	95		dB
Output Voltage Swing	$V_{OUT}$	$V_{CC} - V_{OH}$ , $V_{OL} - V_{EE}$		1.1	1.5	dB
Output Current Drive	$I_{OUT}$	$R_L = 20\Omega$	$\pm 30$	$\pm 45$		mA
Output Short-Circuit Current	$I_{SC}$	Sinking or sourcing to $V_{CC}$ or $V_{EE}$		100		mA
Closed-Loop Output Resistance	$R_{OUT}$			0.035		$\Omega$
Power-Up Time	$t_{PWRUP}$	$V_O = 1V$ step, 0.1% settling time		10		$\mu\text{s}$
Quiescent Supply Current	$I_S$	Normal mode, $EN_- = 5V$ or floating		28	32	mA
		Disable mode, $EN_- = 0$		1.6	5	
Disable Output Leakage Current		$V_{EN_-} = 0$ , $V_{EE} \leq V_{OUT} \leq V_{CC}$		0.2	5	$\mu\text{A}$
$EN_-$ Logic Low Threshold					$V_{CC} - 3.5$	V
$EN_-$ Logic High Threshold			$V_{CC} - 1.5$			V
$EN_-$ Logic Input Low Current		$V_{EN_-} = 0$		5	100	$\mu\text{A}$
$EN_-$ Logic Input High Current		$V_{EN_-} = 5V$		1	30	$\mu\text{A}$

# Ultra-Low-Distortion, Single-Supply, 300MHz Op Amps with Enable

**MAX4265-MAX4270**

## AC ELECTRICAL CHARACTERISTICS

( $V_{CC} = +5V$ ,  $V_{EE} = 0$ ,  $R_L = 100\Omega$  to  $V_{CC}/2$ ,  $V_{CM} = V_{CC}/2$ , MAX4265/MAX4268  $A_V = +1V/V$ , MAX4266/MAX4269  $A_V = +2V/V$ , MAX4267/MAX4270  $A_V = +5V/V$ ,  $T_A = T_{MIN}$  to  $T_{MAX}$ , unless otherwise noted. Typical values are at  $T_A = +25^\circ C$ .)

PARAMETER	SYMBOL	CONDITIONS		MIN	TYP	MAX	UNITS
Small-Signal -3dB Bandwidth	BW <sub>-3dB</sub>	V <sub>OUT</sub> = 100mVp-p	MAX4265/MAX4268		300		MHz
			MAX4266/MAX4269		350		
			MAX4267/MAX4270		200		
Full-Power Bandwidth	FPBW	V <sub>OUT</sub> = 1Vp-p	MAX4265/MAX4268		175		MHz
			MAX4266/MAX4269		200		
			MAX4267/MAX4270		200		
0.1dB Gain Flatness	BW <sub>0.1dB</sub>	V <sub>OUT</sub> = 100mVp-p	MAX4265/MAX4268		100		MHz
			MAX4266/MAX4269		35		
			MAX4267/MAX4270		35		
All-Hostile Crosstalk		f = 10MHz			85		dB
Slew Rate	SR	V <sub>OUT</sub> = 1V step			900		V/ $\mu$ s
Rise/Fall Times	t <sub>r</sub> , t <sub>f</sub>	V <sub>OUT</sub> = 1V step			1		ns
Settling Time (0.1%)	t <sub>s,0.1</sub>	V <sub>OUT</sub> = 1V step			15		ns
Spurious-Free Dynamic Range	SFDR	V <sub>OUT</sub> = 1Vp-p (MAX4269)	f <sub>C</sub> = 1MHz		88		dBc
			f <sub>C</sub> = 5MHz		90		
			f <sub>C</sub> = 10MHz		87		
			f <sub>C</sub> = 20MHz		78		
			f <sub>C</sub> = 60MHz		68		
			f <sub>C</sub> = 100MHz		60		
Second Harmonic Distortion		V <sub>OUT</sub> = 1Vp-p (MAX4269)	f <sub>C</sub> = 1MHz		88		dBc
			f <sub>C</sub> = 5MHz		90		
			f <sub>C</sub> = 10MHz		87		
			f <sub>C</sub> = 20MHz		78		
			f <sub>C</sub> = 60MHz		68		
			f <sub>C</sub> = 100MHz		60		
Third Harmonic Distortion		V <sub>OUT</sub> = 1Vp-p (MAX4269)	f <sub>C</sub> = 1MHz		96		dBc
			f <sub>C</sub> = 5MHz		95		
			f <sub>C</sub> = 10MHz		92		
			f <sub>C</sub> = 20MHz		86		
			f <sub>C</sub> = 60MHz		72		
			f <sub>C</sub> = 100MHz		68		

# Ultra-Low-Distortion, Single-Supply, 300MHz Op Amps with Enable

## AC ELECTRICAL CHARACTERISTICS (continued)

( $V_{CC} = +5V$ ,  $V_{EE} = 0$ ,  $R_L = 100\Omega$  to  $V_{CC}/2$ ,  $V_{CM} = V_{CC}/2$ , MAX4265/MAX4268  $A_V = +1V/V$ , MAX4266/MAX4269  $A_V = +2V/V$ , MAX4267/MAX4270  $A_V = +5V/V$ ,  $T_A = T_{MIN}$  to  $T_{MAX}$ , unless otherwise noted. Typical values are at  $T_A = +25^\circ C$ .)

PARAMETER	SYMBOL	CONDITIONS	MIN	TYP	MAX	UNITS
Two-Tone, Third-Order Intercept Distortion	IP3	$V_{OUT} = 1V_{p-p}$ , $f_{CA} = 20MHz$ , $f_{CB} = 21.25MHz$ (MAX4269)		35		dBm
Input -1dB Compression Point		$f_C = 20MHz$		12		dBm
Differential Gain	$D_G$	NTSC, $f = 3.58MHz$ , $R_L = 150\Omega$ to $V_{CC}/2$		0.015		%
Differential Phase	$D_P$	NTSC, $f = 3.58MHz$ , $R_L = 150\Omega$ to $V_{CC}/2$		0.03		degrees
Input Capacitance	$C_{IN}$			2		pF
Output Impedance	$R_{OUT}$	$f = 10MHz$		1		$\Omega$
Disabled Output Capacitance		$V_{EN\_} = 0$		5		pF
Enable Time	$t_{EN}$	$V_{IN} = 1V$		100		ns
Disable Time	$t_{DIS}$	$V_{IN} = 1V$		750		$\mu s$
Capacitive Load Stability		No sustained oscillation	MAX4265/MAX4268	15		pF
			MAX4266/MAX4269	15		
			MAX4267/MAX4270	22		
Input Voltage Noise Density	$e_n$	$f = 1kHz$		8		$nV/\sqrt{Hz}$
Input Current Noise Density	$i_n$	$f = 1kHz$		1		$pA/\sqrt{Hz}$

## Typical Operating Characteristics

( $V_{CC} = +5V$ ,  $V_{EE} = 0$ ,  $V_{EN\_} = 5V$ ,  $R_L = 100\Omega$  to  $V_{CC}/2$ , MAX4268  $A_V = +1V/V$ , MAX4269  $A_V = +2V/V$ , MAX4270  $A_V = +5V/V$ ,  $T_A = +25^\circ C$ , unless otherwise noted.)

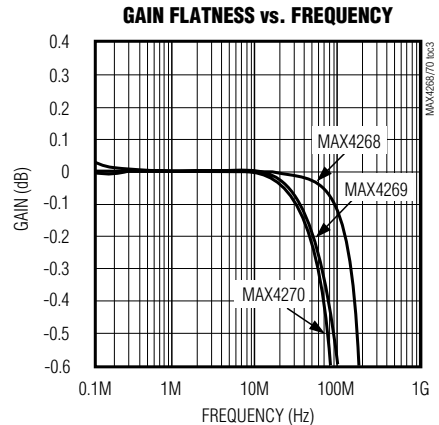
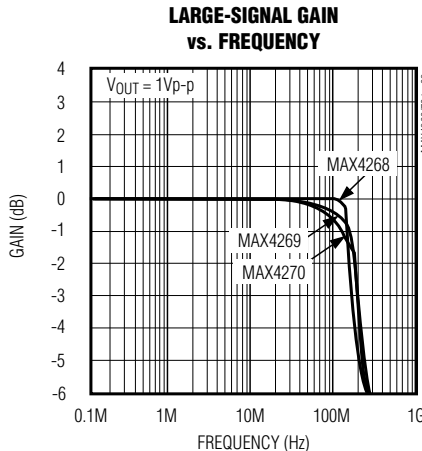
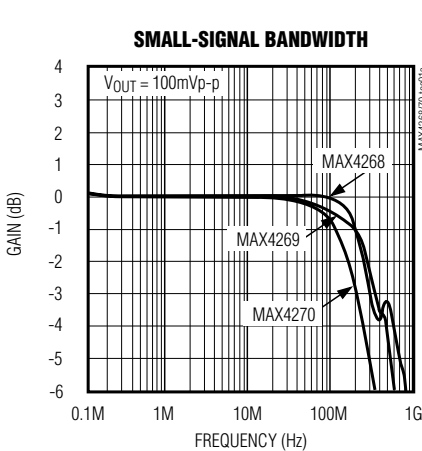

# Ultra-Low-Distortion, Single-Supply, 300MHz Op Amps with Enable

**MAX4265-MAX4270**

## Typical Operating Characteristics (continued)

( $V_{CC} = +5V$ ,  $V_{EE} = 0$ ,  $EN_L = 5V$ ,  $R_L = 100\Omega$  to  $V_{CC}/2$ , MAX4268  $A_V = +1V/V$ , MAX4269  $A_V = +2V/V$ , MAX4270  $A_V = +5V/V$ ,  $T_A = +25^\circ C$ , unless otherwise noted.)

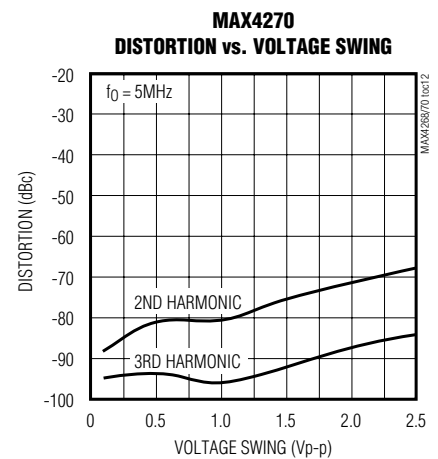
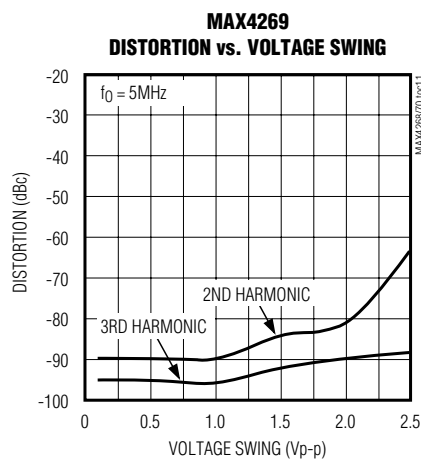
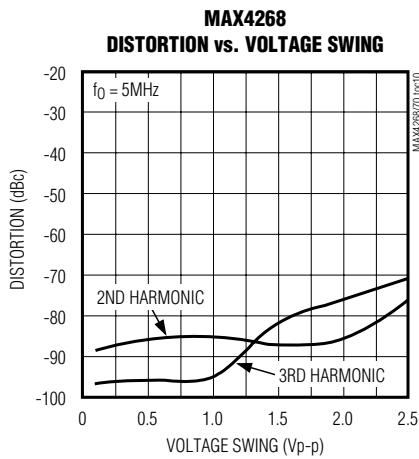
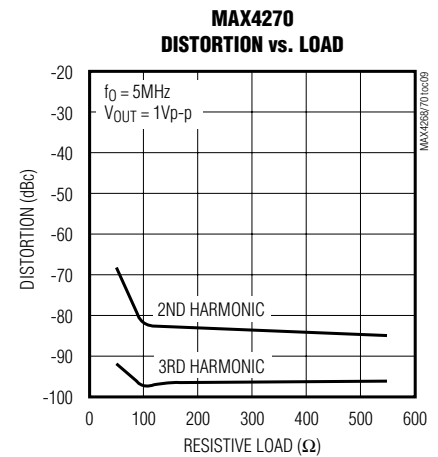
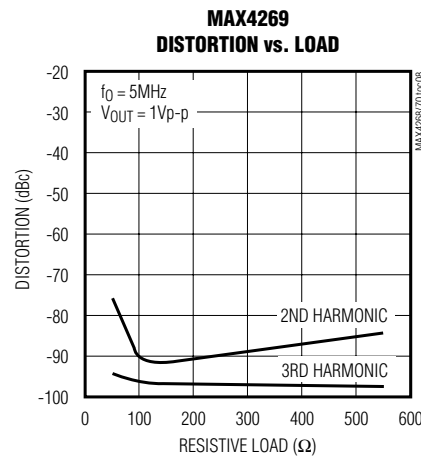
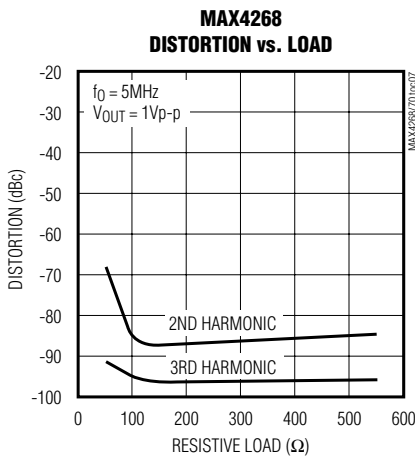
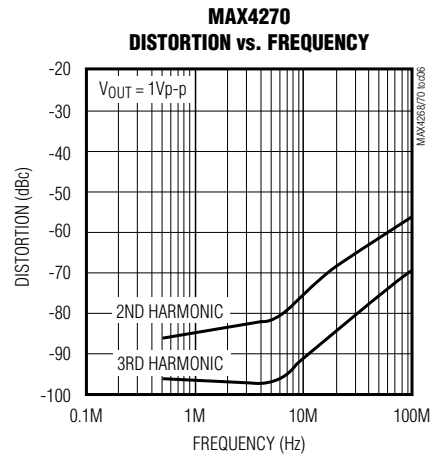
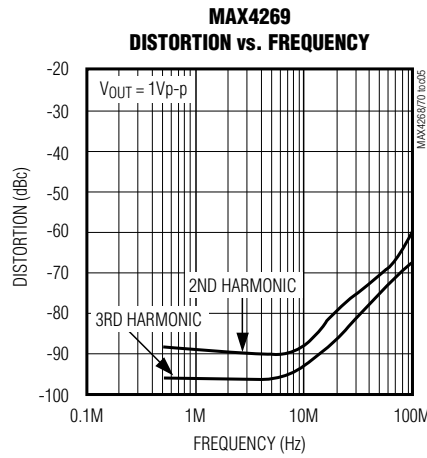
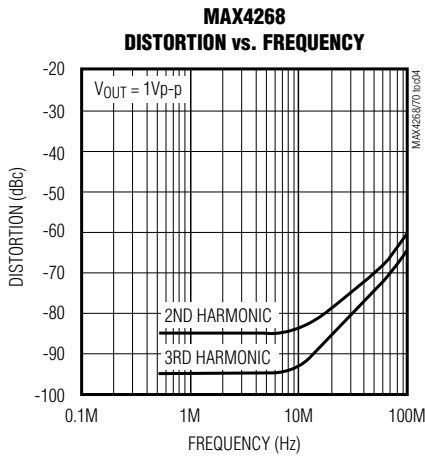

# Ultra-Low-Distortion, Single-Supply, 300MHz Op Amps with Enable

## Typical Operating Characteristics (continued)

( $V_{CC} = +5V$ ,  $V_{EE} = 0$ ,  $EN_L = 5V$ ,  $R_L = 100\Omega$  to  $V_{CC}/2$ , MAX4268  $A_V = +1V/V$ , MAX4269  $A_V = +2V/V$ , MAX4270  $A_V = +5V/V$ ,  $T_A = +25^\circ C$ , unless otherwise noted.)

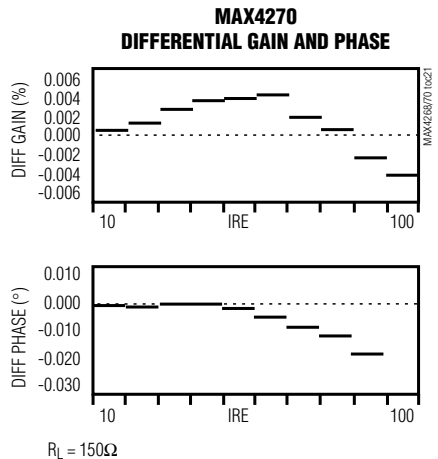
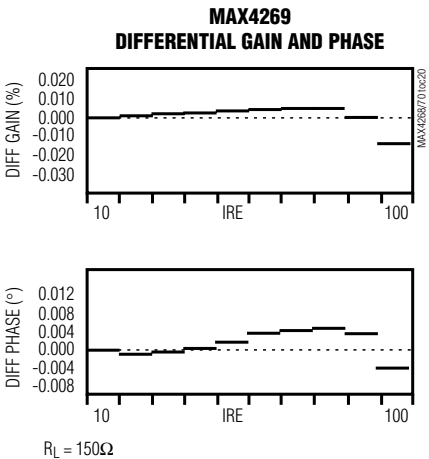
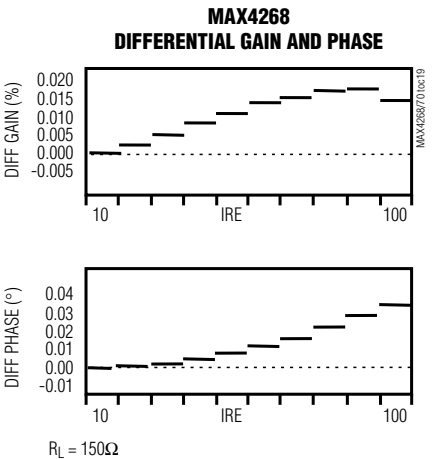
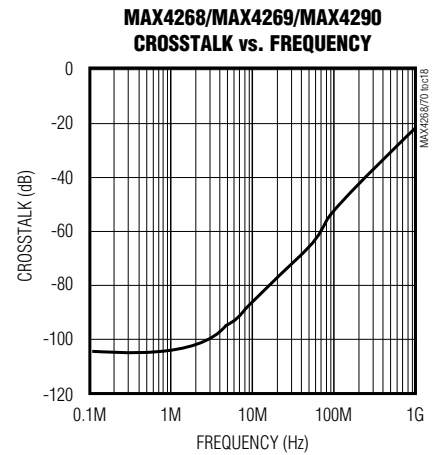
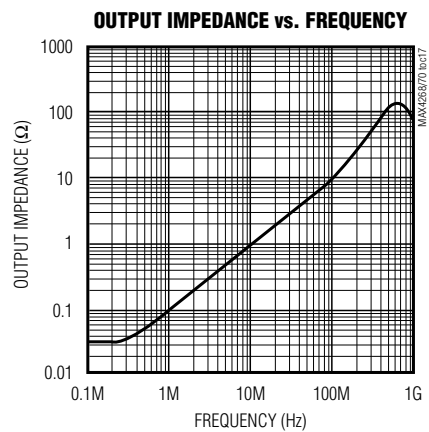
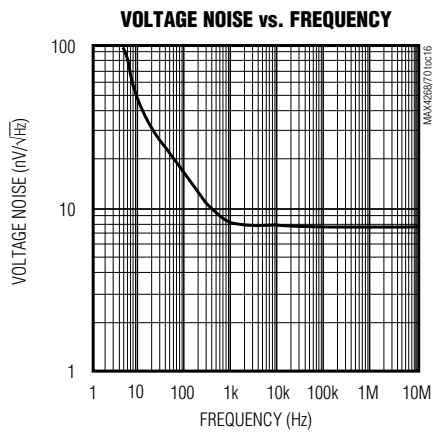
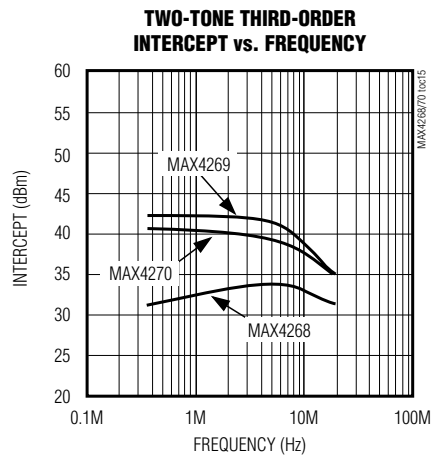
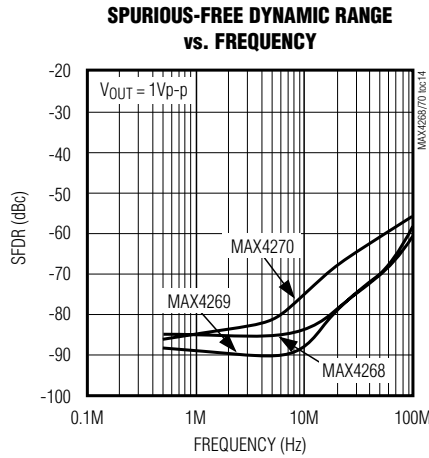
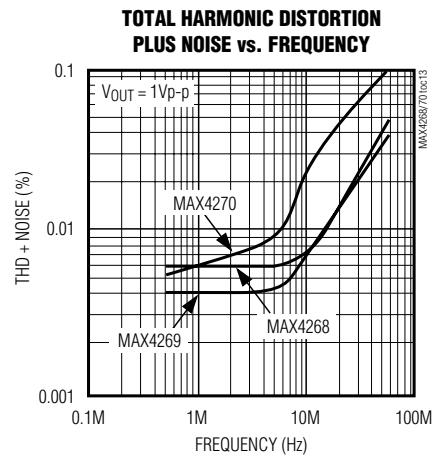

# Ultra-Low-Distortion, Single-Supply, 300MHz Op Amps with Enable

MAX4265-MAX4270

## Typical Operating Characteristics (continued)

( $V_{CC} = +5V$ ,  $V_{EE} = 0$ ,  $EN_L = 5V$ ,  $R_L = 100\Omega$  to  $V_{CC}/2$ , MAX4268  $A_V = +1V/V$ , MAX4269  $A_V = +2V/V$ , MAX4270  $A_V = +5V/V$ ,  $T_A = +25^\circ C$ , unless otherwise noted.)

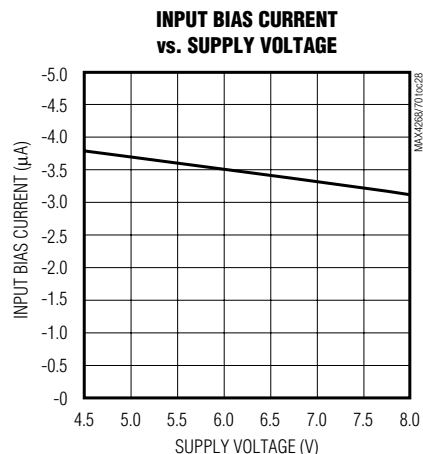
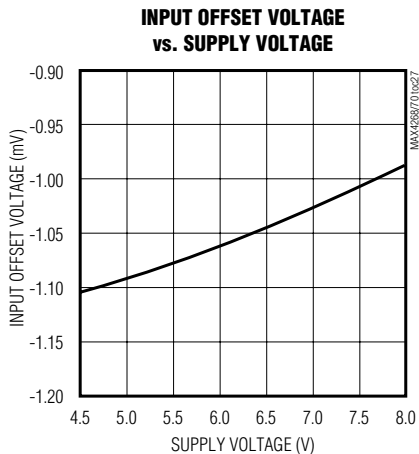
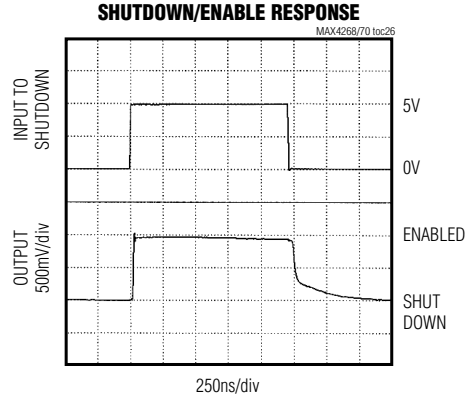
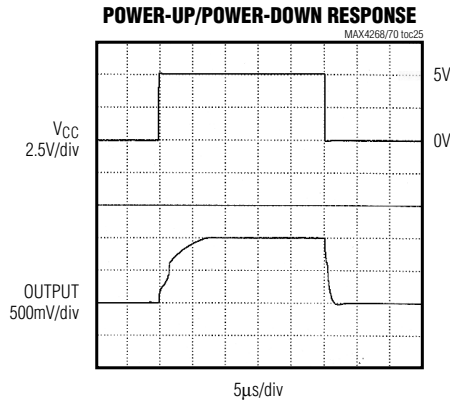
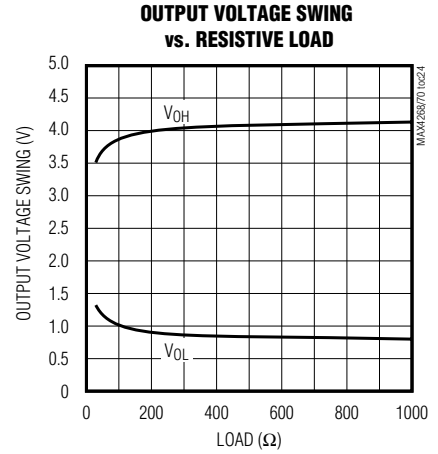
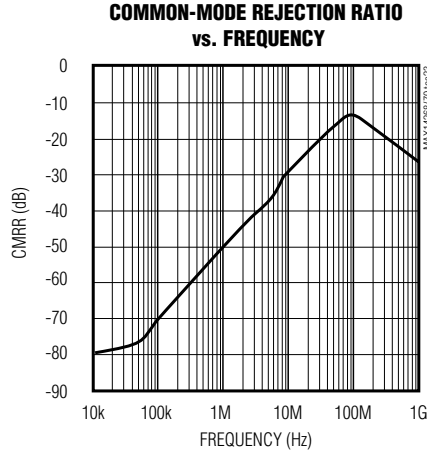
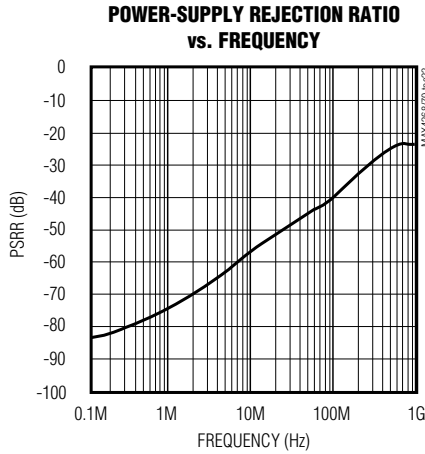

# Ultra-Low-Distortion, Single-Supply, 300MHz Op Amps with Enable

## Typical Operating Characteristics (continued)

( $V_{CC} = +5V$ ,  $V_{EE} = 0$ ,  $EN_L = 5V$ ,  $R_L = 100\Omega$  to  $V_{CC}/2$ , MAX4268  $A_V = +1V/V$ , MAX4269  $A_V = +2V/V$ , MAX4270  $A_V = +5V/V$ ,  $T_A = +25^\circ C$ , unless otherwise noted.)

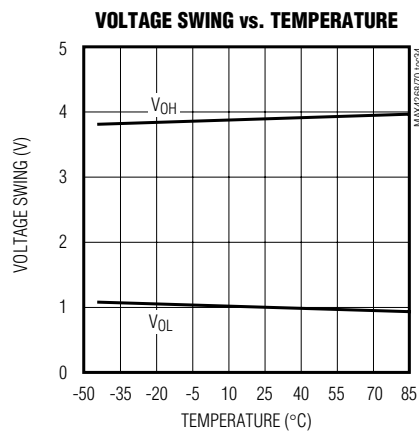
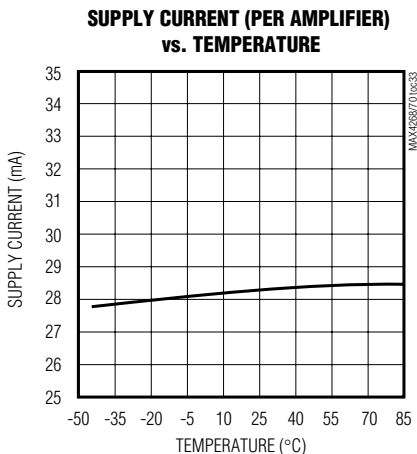
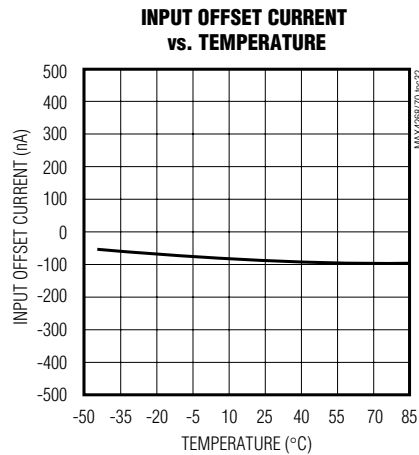
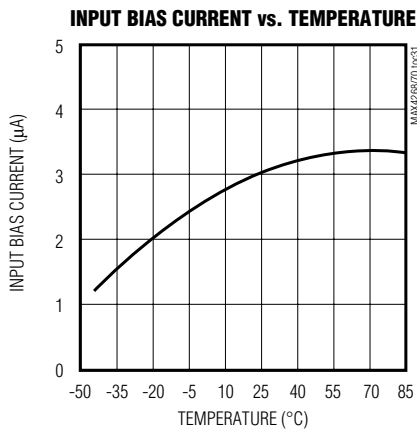
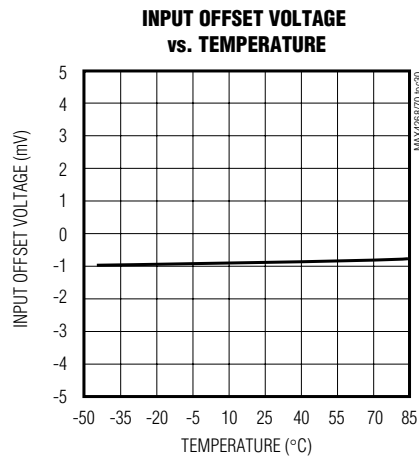
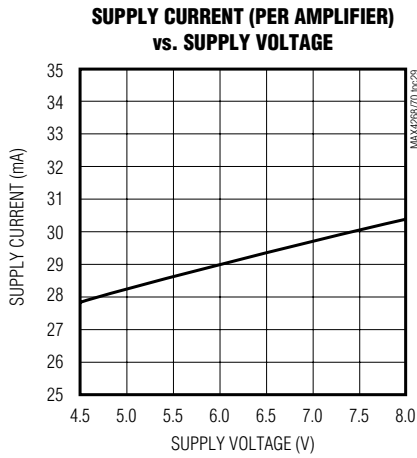



# Ultra-Low-Distortion, Single-Supply, 300MHz Op Amps with Enable

## Typical Operating Characteristics (continued)

( $V_{CC} = +5V$ ,  $V_{EE} = 0$ ,  $EN_L = 5V$ ,  $R_L = 100\Omega$  to  $V_{CC}/2$ , MAX4268  $A_V = +1V/V$ , MAX4269  $A_V = +2V/V$ , MAX4270  $A_V = +5V/V$ ,  $T_A = +25^\circ C$ , unless otherwise noted.)

**MAX4265-MAX4270**

**MAX4268**  
SMALL-SIGNAL PULSE RESPONSE

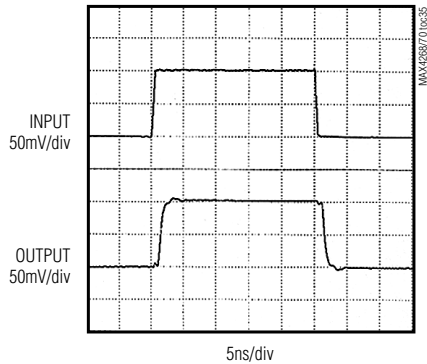

**MAX4269**  
SMALL-SIGNAL PULSE RESPONSE

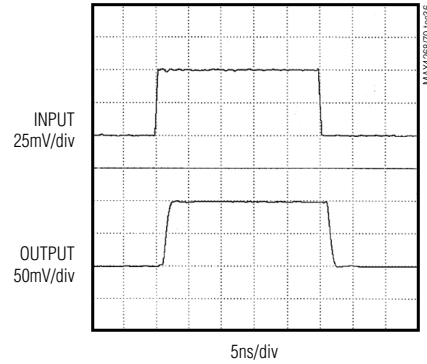

**MAX4270**  
SMALL-SIGNAL PULSE RESPONSE

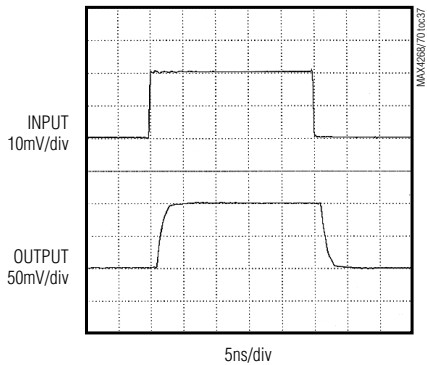

**MAX4268**  
LARGE-SIGNAL PULSE RESPONSE

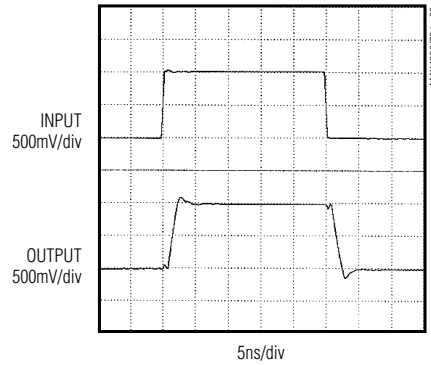

**MAX4269**  
LARGE-SIGNAL PULSE RESPONSE

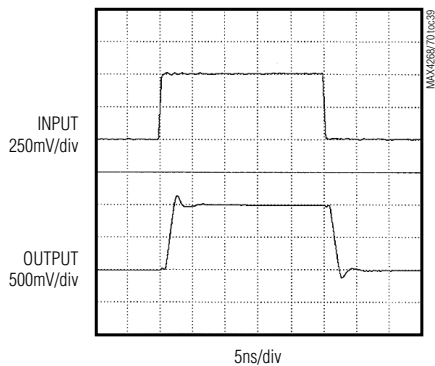

**MAX4270**  
LARGE-SIGNAL PULSE RESPONSE

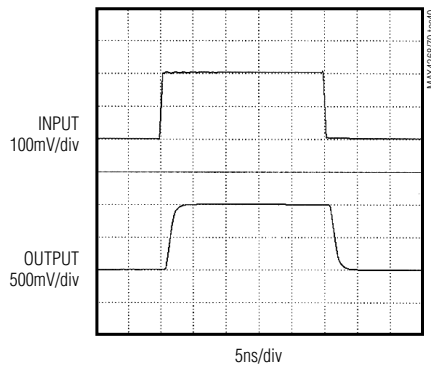

# Ultra-Low-Distortion, Single-Supply, 300MHz Op Amps with Enable

## Pin Description

PIN			NAME	FUNCTION
MAX4265 MAX4266 MAX4267	MAX4268 MAX4269 MAX4270			
8 $\mu$ MAX/SO	14 SO	16 QSOP		
1	—	—	EN	Enable Input. Active high. Connect to $V_{CC}$ for normal operation.
—	4, 5	4, 5	ENA, ENB	Enable Input. Active high. Connect to $V_{CC}$ for normal operation.
2	—	—	IN-	Inverting Input
—	2, 9	2, 11	INA-, INB-	Inverting Input
3	—	—	IN+	Noninverting Input
—	3, 10	3, 12	INA+, INB+	Noninverting Input
4, 5	6, 7	6, 7	$V_{EE}$	Negative Power Supply
6	—	—	OUT	Amplifier Output
—	1, 8	1, 10	OUTA, OUTB	Amplifier Output
7, 8	13, 14	15, 16	$V_{CC}$	Positive Power Supply. Connect to a +4.5V to +8.0V supply and bypass with a 0.1 $\mu$ F capacitor for single-supply operation.
—	11, 12	8, 9, 13, 14	N.C.	No Connection. Not internally connected.

### Detailed Description

The MAX4265–MAX4270 single-supply operational amplifiers feature ultra-low distortion and wide bandwidth. Their low distortion and low noise make them ideal for driving high-speed analog-to-digital converters (ADCs) up to 16 bits in telecommunications applications and high-performance signal processing.

These devices can drive loads as low as 100 $\Omega$  and deliver 45mA while maintaining DC accuracy and AC performance. The input common-mode voltage ranges from ( $V_{EE} + 1.6V$ ) to ( $V_{CC} - 1.6V$ ), while the output swings to within 1.1V of the rails.

#### Low Distortion

The MAX4265–MAX4270 use proprietary bipolar technology to achieve minimum distortion in single-supply systems—a feature typically available only in dual-supply op amps.

Several factors can affect the noise and distortion that a device contributes to the input signal. The following guidelines explain how various design choices impact the total harmonic distortion (THD).

- Choose the proper feedback-resistor and gain-resistor values for the application. In general, the smaller the closed-loop gain, the smaller the THD generated—especially when driving heavy resistive loads. Large-value feedback resistors can significantly improve distortion. The MAX4265–MAX4270's THD normally increases at approximately 20dB per decade at frequencies above 1MHz; this is a lower rate than that of comparable dual-supply op amps.
- Operating the device near or above the full-power bandwidth significantly degrades distortion (see the Total Harmonic Distortion vs. Frequency graph in the *Typical Operating Characteristics*).
- The decompensated devices (MAX4266/MAX4267/MAX4269/MAX4270) deliver the best distortion performance since they have a slightly higher slew rate and provide a higher amount of loop gain for a given closed-loop gain setting.

# Ultra-Low-Distortion, Single-Supply, 300MHz Op Amps with Enable

MAX4265-MAX4270

## Choosing Resistor Values Unity-Gain Configurations

The MAX4265 and MAX4268 are internally compensated for unity gain. When configured for unity gain, they require a small resistor ( $R_F$ ) in series with the feedback path (Figure 1). This resistor improves AC response by reducing the Q of the tank circuit, which is formed by parasitic feedback inductance and capacitance.

## Inverting and Noninverting Configurations

The values of the gain-setting feedback and input resistors are important design considerations. Large resistor values will increase voltage noise and interact with the amplifier's input and PC board capacitance to generate undesirable poles and zeros, which can decrease bandwidth or cause oscillations. For example, a noninverting gain of  $+2V/V$  (Figure 1) using  $R_F = R_G = 1k\Omega$  combined with 2pF of input capacitance and 0.5pF of board capacitance will cause a feedback pole at 128MHz. If this pole is within the anticipated amplifier bandwidth, it will jeopardize stability. Reducing the 1k $\Omega$  resistors to 100 $\Omega$  extends the pole frequency to 1.28GHz, but could limit output swing by adding 200 $\Omega$  in parallel with the amplifier's load. Clearly, the selection of resistor values must be tailored to the specific application.

## Distortion Considerations

The MAX4265-MAX4270 are ultra-low-distortion, high-bandwidth op amps. Output distortion will degrade as the total load resistance seen by the amplifier decreases. To minimize distortion, keep the input and gain-setting resistor values relatively large. A 500 $\Omega$  feedback resistor combined with an appropriate input resistor to set the gain will provide excellent AC performance without significantly increasing distortion.

## Noise Considerations

The amplifier's input-referred noise-voltage density is dominated by flicker noise at lower frequencies and by thermal noise at higher frequencies. Because the thermal noise contribution is affected by the parallel combination of the feedback resistive network, those resistor values should be reduced in cases where the system bandwidth is large and thermal noise is dominant. This noise-contribution factor decreases, however, with increasing gain settings. For example, the input noise voltage density at the op amp input with a gain of  $+10V/V$  using  $R_F = 100k\Omega$  and  $R_G = 11k\Omega$  is  $e_n = 18nV/\sqrt{Hz}$ . The input noise can be reduced to  $8nV/\sqrt{Hz}$  by choosing  $R_F = 1k\Omega$ ,  $R_G = 110\Omega$ .

## Driving Capacitive Loads

The MAX4265-MAX4270 are not designed to drive highly reactive loads; stability is maintained with loads up to 15pF with less than 2dB peaking in the frequency response. To drive higher capacitive loads, place a small isolation resistor in series between the amplifier's output and the capacitive load (Figure 1). This resistor improves the amplifier's phase margin by isolating the capacitor from the op amp's output.

To ensure a load capacitance that limits peaking to less than 2dB, select a resistance value from Figure 2. For example, if the capacitive load is 100pF, the corresponding isolation resistor is 6 $\Omega$  (MAX4269). Figures 3 and 4 show the peaking that occurs in the frequency response with and without an isolation resistor.

Coaxial cable and other transmission lines are easily driven when terminated at both ends with their characteristic impedance. When driving back-terminated transmission lines, the capacitive load of the transmission line is essentially eliminated.

## ADC Input Buffer

Input buffer amplifiers can be a source of significant errors in high-speed ADC applications. The input buffer is usually required to rapidly charge and discharge the ADC's input, which is often capacitive (see *Driving Capacitive Loads*). In addition, since a high-speed ADC's input impedance often changes very rapidly during the conversion cycle, measurement accuracy must

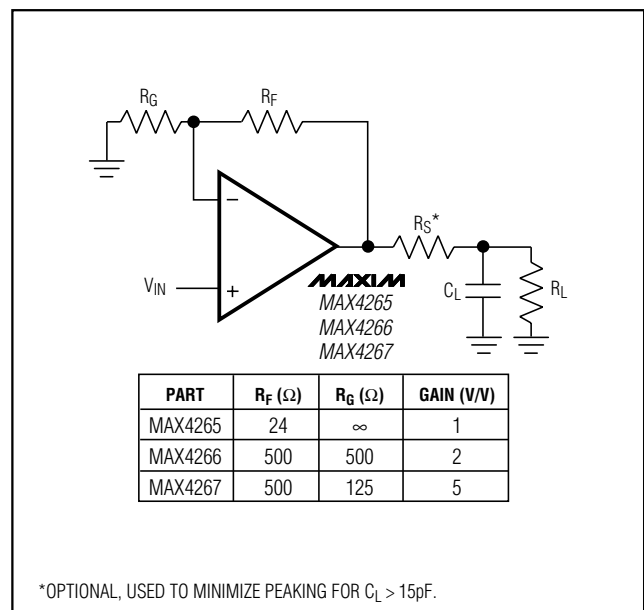

Figure 1. Noninverting Configuration

# Ultra-Low-Distortion, Single-Supply, 300MHz Op Amps with Enable

be maintained using an amplifier with very low output impedance at high frequencies. The combination of high speed, fast slew rate, low noise, and a low and stable distortion over load makes the MAX4265–MAX4270 ideally suited for use as buffer amplifiers in high-speed ADC applications.

## Low-Power Disable Mode

The MAX4265–MAX4270 feature an active-high enable pin that can be used to save power and place the outputs in a high-impedance state. Drive EN\_ with logic levels or connect EN\_ to VCC for normal operation. In the dual versions (MAX4268/MAX4269/MAX4270), each individual op amp is enabled separately, allowing the devices to be used in a multiplex configuration. The supply current in low-power mode is reduced to 1.6mA per device. Enable time is typically 100ns, and disable time is typically 750µs.

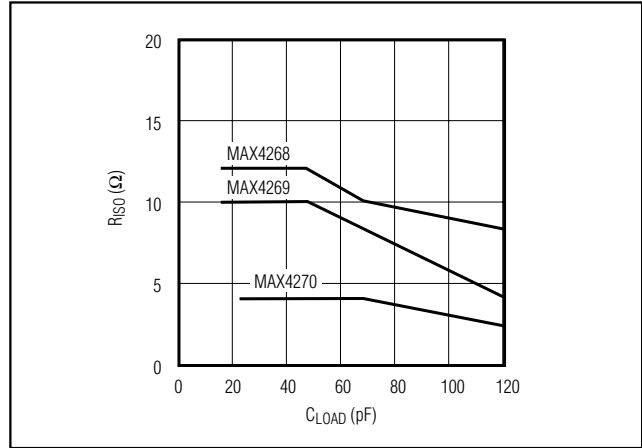

Figure 2. MAX4268/MAX4269/MAX4270 Isolation Resistance vs. Capacitive Load

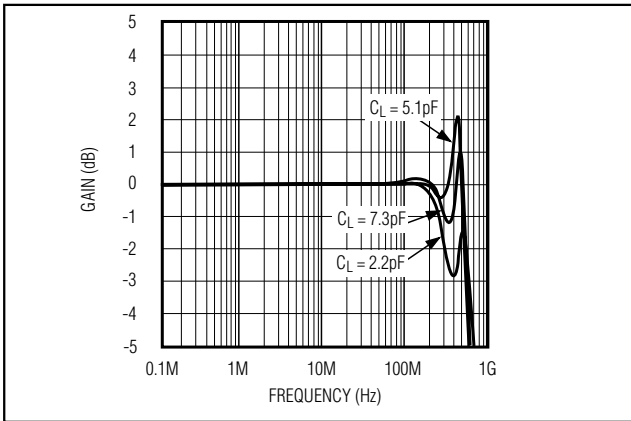

Figure 3a. MAX4268 Small-Signal Gain vs. Frequency Without Isolation Resistor

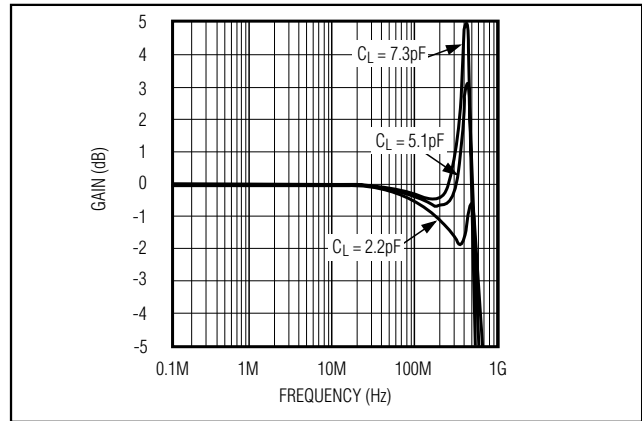

Figure 3b. MAX4269 Small-Signal Gain vs. Frequency Without Isolation Resistor

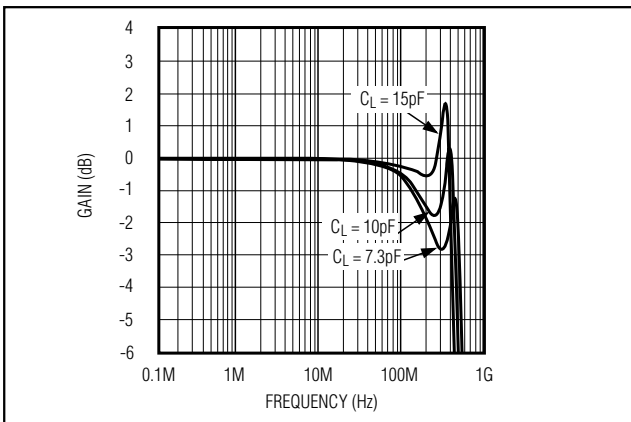

Figure 3c. MAX4270 Small-Signal Gain vs. Frequency Without Isolation Resistor

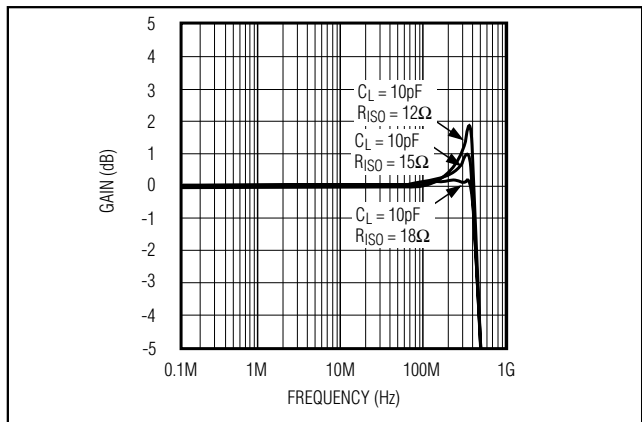

Figure 4a. MAX4268 Small-Signal Gain vs. Frequency With Isolation Resistor

# Ultra-Low-Distortion, Single-Supply, 300MHz Op Amps with Enable

**MAX4265-MAX4270**

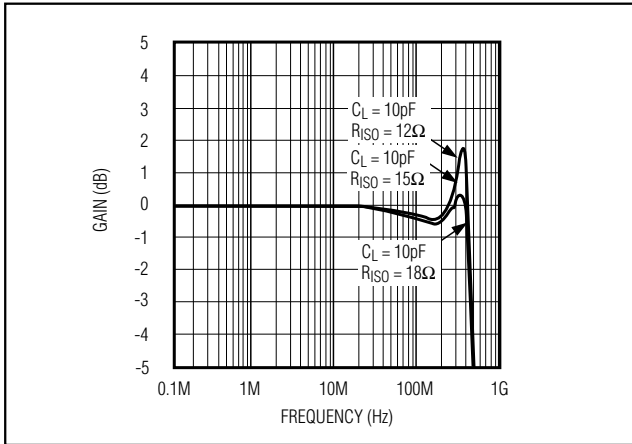

Figure 4b. MAX4269 Small-Signal Gain vs. Frequency With Isolation Resistor

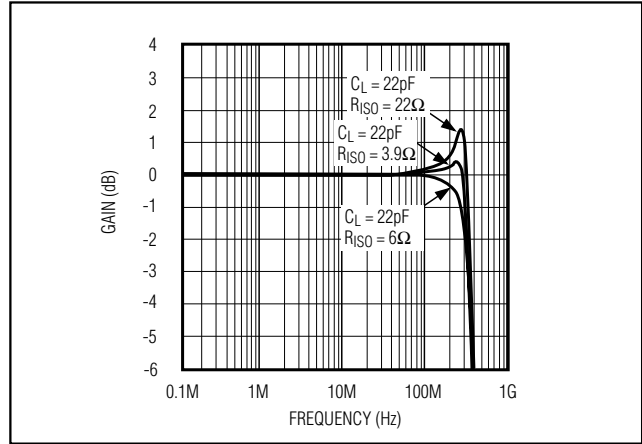

Figure 4c. MAX4270 Small-Signal Gain vs. Frequency With Isolation Resistor

## Power Supplies and Layout

The MAX4265–MAX4270 operate from a single +4.5V to +8.0V power supply or from dual  $\pm 2.25\text{V}$  to  $\pm 4.0\text{V}$  supplies. For single-supply operation, bypass each power-supply input with a  $0.1\mu\text{F}$  ceramic capacitor placed close to the VCC pins, and an additional  $10\mu\text{F}$  to VEE. When operating from dual supplies, bypass each supply to ground.

Good layout improves performance by decreasing the amount of stray capacitance and noise at the op amp's inputs and output. To decrease stray capacitance, minimize PC board trace lengths and resistor leads, and place external components close to the op amp's pins.

## Chip Information

TRANSISTOR COUNT: MAX4265/66/67: 132

MAX4268/69/70: 285

# Ultra-Low-Distortion, Single-Supply, 300MHz Op Amps with Enable

## Pin Configurations

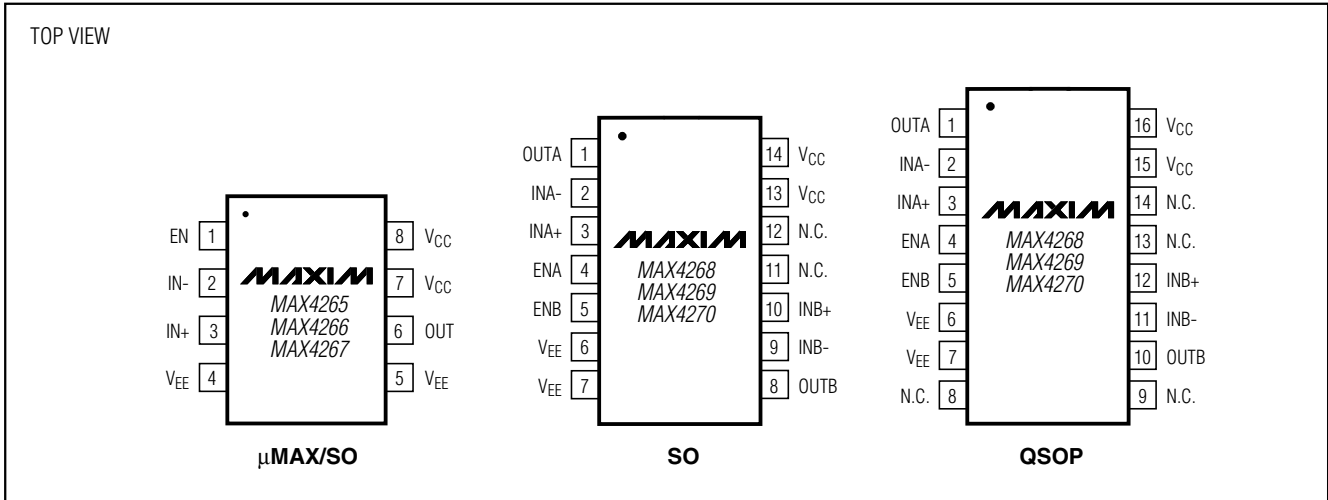

# Ultra-Low-Distortion, Single-Supply, 300MHz Op Amps with Enable

## Package Information

MAX4265-MAX4270

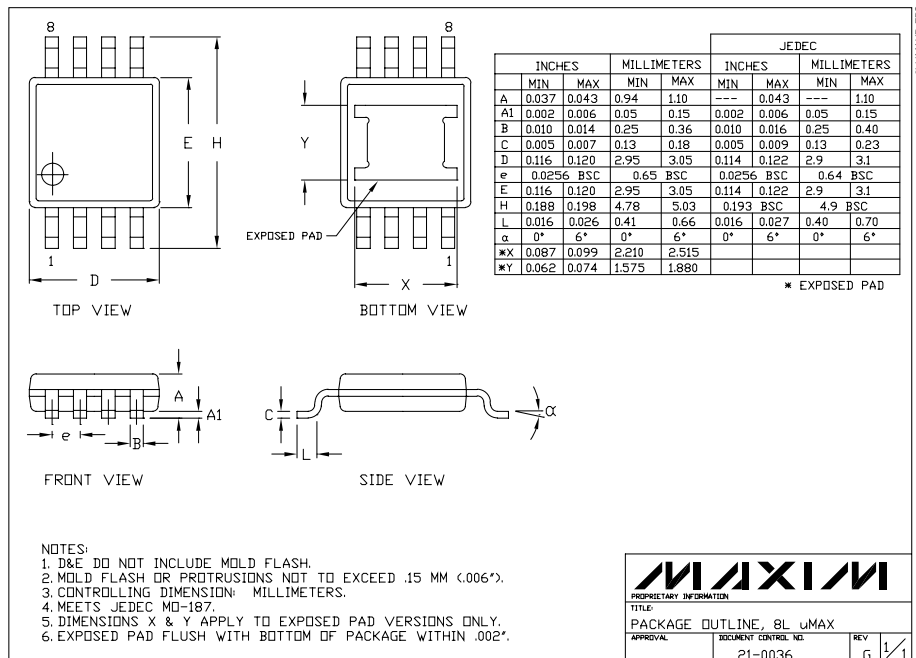
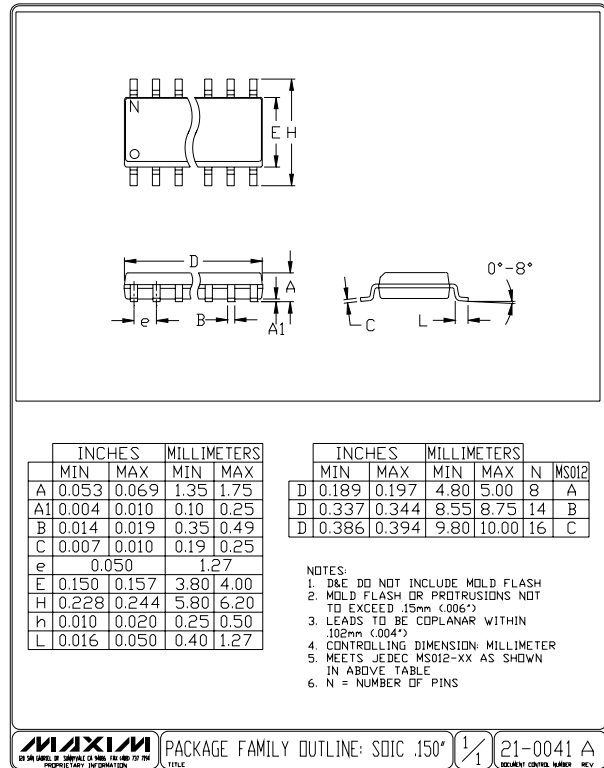

# Ultra-Low-Distortion, Single-Supply, 300MHz Op Amps with Enable

## Package Information (continued)

QSOP EPSS

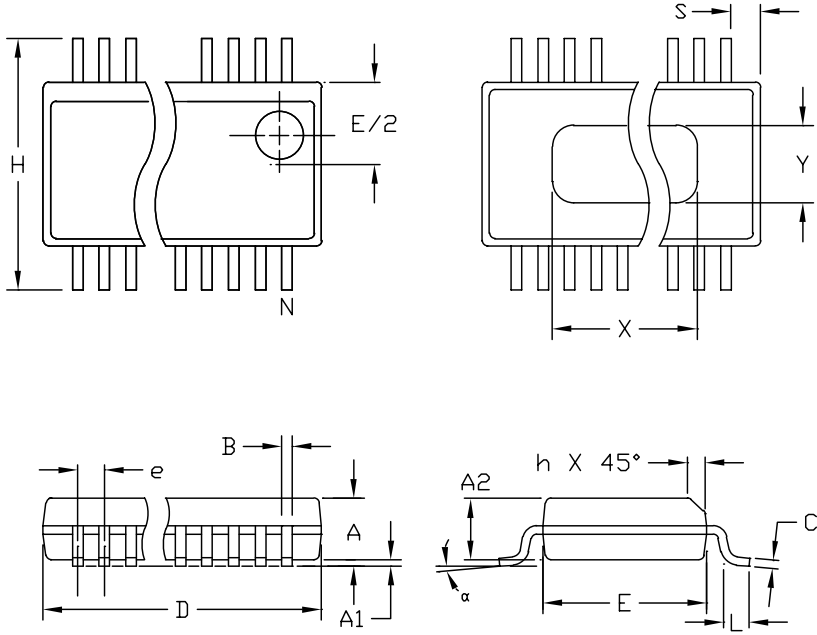

DIM	INCHES		MILLIMETERS	
	MIN	MAX	MIN	MAX
A	.061	.068	1.55	1.73
A1	.004	.0098	0.102	0.249
A2	.055	.061	1.40	1.55
B	.008	.012	0.20	0.31
C	.0075	.0098	0.191	0.249
D	SEE VARIATIONS			
E	.150	.157	3.81	3.99
e	.025 BSC		0.635 BSC	
H	.230	.244	5.84	6.20
h	.010	.016	0.25	0.41
L	.016	.035	0.41	0.89
N	SEE VARIATIONS			
X	SEE VARIATIONS			
Y	.071	.087	1.803	2.209
α	0°	8°	0°	8°

**VARIATIONS:**

DIM	INCHES		MILLIMETERS		N
	MIN	MAX	MIN	MAX	
D	.189	.196	4.80	4.98	16   AA
S	.0020	.0070	0.05	0.18	
X	.107	.123	2.72	3.12	
D	.337	.344	8.56	8.74	20   AB
S	.0500	.0550	1.270	1.397	
D	.337	.344	8.56	8.74	24   AC
S	.0250	.0300	0.635	0.762	
D	.386	.393	9.80	9.98	28   AD
S	.0250	.0300	0.635	0.762	
X	.271	.287	6.88	7.29	

**NOTES:**

1. D & E DO NOT INCLUDE MOLD FLASH OR PROTRUSIONS
2. MOLD FLASH OR PROTRUSIONS NOT TO EXCEED .006" PER SIDE.
3. HEAT SLUG DIMENSIONS X AND Y APPLY ONLY TO 16 AND 28 LEAD POWER-QSOP PACKAGES.
4. CONTROLLING DIMENSIONS: INCHES.

**MAXIM**

PROPRIETARY INFORMATION

TITLE:

PACKAGE OUTLINE, QSOP, .150", .025" LEAD PITCH

APPROVAL	DOCUMENT CONTROL NO.	REV	1/1
	21-0055	B	

Maxim cannot assume responsibility for use of any circuitry other than circuitry entirely embodied in a Maxim product. No circuit patent licenses are implied. Maxim reserves the right to change the circuitry and specifications without notice at any time.

16 \_\_\_\_\_ **Maxim Integrated Products, 120 San Gabriel Drive, Sunnyvale, CA 94086 408-737-7600**