



+3V/+5V, 250MHz, SOT23 ADC Buffer Amplifiers with High-Speed Disable

General Description

The MAX4285/MAX4286 single and MAX4287/MAX4288/MAX4387/MAX4388 dual ADC buffer amplifiers feature high-speed performance and single +3V supply operation. The MAX4285/MAX4286/MAX4288 and MAX4388 offer a disable feature that reduces power-supply current and places the outputs in a high-impedance state. All six devices operate from a +2.85V to +6.5V single supply or from $\pm 1.425V$ to $\pm 3.25V$ dual supplies. The common-mode input voltage range extends to the negative power-supply rail (ground in single-supply applications).

These devices require 20mA of quiescent supply current per amplifier while achieving a 250MHz -3dB bandwidth and a 350V/ μ s slew rate. The combination of an 8ns (to 0.1%) settling time, 88dBc (f = 5MHz) of SFDR, and up to 100mA output drive makes these amplifiers ideal for high-speed ADC drivers for communications and instrumentation applications. In addition, when disabled, their high output impedance makes them ideal for multiplexing applications.

The MAX4285/MAX4286 are available in space-saving 6-pin SOT23 and 8-pin SO packages. The MAX4287/MAX4387 come in 8-pin μ MAX and 8-pin SO packages, while the MAX4288/MAX4388 come in 10-pin μ MAX and 14-pin SO packages.

Applications

High-Speed ADC Drivers
Communications Equipment
Instrumentation
CCD Imaging Systems
Ultrasound

Typical Operating Circuit appears at end of data sheet.

Pin Configurations appear at end of data sheet.

Features

- ◆ High Speed at 3V
 - 250MHz -3dB Bandwidth (MAX4285/87/88)
 - 150MHz -3dB Bandwidth (MAX4286, MAX4387/88)
 - 350V/ μ s Slew Rate
- ◆ +2.85V to +6.5V Single-Supply Operation
- ◆ Input Common-Mode Range Extends to V_{EE}
- ◆ Low Distortion at 5MHz
 - 88dBc SFDR
- ◆ High Output Current Drive: -106mA to +77mA
- ◆ 6ns Settling Time to 0.1%
- ◆ High-Speed Enable/Disable
 - 40ns Enable Time
 - 50ns Disable Time
 - High Output Impedance
- ◆ Space-Saving SOT23 and μ MAX Packages

Ordering Information

| PART | TEMP. RANGE | PIN-PACKAGE | SOT TOP MARK |
|--------------|----------------|-------------|--------------|
| MAX4285EUT-T | -40°C to +85°C | 6 SOT23-6 | AABQ |
| MAX4285ESA | -40°C to +85°C | 8 SO | — |
| MAX4286EUT-T | -40°C to +85°C | 6 SOT23-6 | AABR |
| MAX4286ESA | -40°C to +85°C | 8 SO | — |
| MAX4287EUA | -40°C to +85°C | 8 μ MAX | — |
| MAX4287ESA | -40°C to +85°C | 8 SO | — |

Ordering Information continued at end of data sheet.

Selector Guide

| PART | OP AMPS PER PKG | MIN GAIN | -3dB BANDWIDTH (AT MIN GAIN) | HIGH-SPEED DISABLE | PIN-PACKAGE |
|---------|-----------------|----------|------------------------------|--------------------|-----------------------------|
| MAX4285 | 1 | 1 | 250MHz | Yes | 6-pin SOT23, 8-pin SO |
| MAX4286 | 1 | 5 | 150MHz | Yes | 6-pin SOT23, 8-pin SO |
| MAX4287 | 2 | 1 | 250MHz | No | 8-pin μ MAX/SO |
| MAX4288 | 2 | 1 | 250MHz | Yes | 10-pin μ MAX/14-pin SO |
| MAX4387 | 2 | 5 | 150MHz | No | 8-pin μ MAX/SO |
| MAX4388 | 2 | 5 | 150MHz | Yes | 10-pin μ MAX, 14-pin SO |



+3V/+5V, 250MHz, SOT23 ADC Buffer Amplifiers with High-Speed Disable

ABSOLUTE MAXIMUM RATINGS

| | | | |
|------------------------------------------------------|--------------------------------------------|------------------------------------------------|-----------------|
| Supply Voltage ($V_{CC} - V_{EE}$) | -0.3V to +7.5V | 8-Pin μ MAX (derate 4.1mW/°C above +70°C) | 330mW |
| Input Voltage Range (IN+, IN-) | ($V_{EE} - 0.3V$) to ($V_{CC} + 0.3V$) | 10-Pin μ MAX (derate 5.6mW/°C above +70°C) | 444mW |
| Differential Input Voltage | -0.3V to +7.5V | 8-Pin SO (derate 5.88mW/°C above +70°C) | 471mW |
| Voltage at $\overline{DISABLE}$ | ($V_{EE} - 0.3V$) to ($V_{CC} + 0.3V$) | 14-Pin SO (derate 8.3mW/°C above +70°C) | 667mW |
| Current into IN+, IN-, $\overline{DISABLE}$ | $\pm 20mA$ | Operating Temperature Range | -40°C to +85°C |
| Output Short-Circuit Duration | Indefinite | Junction Temperature | +150°C |
| Continuous Power Dissipation ($T_A = +70^\circ C$) | | Storage Temperature Range | -65°C to +150°C |
| 6-Pin SOT23 (derate 7.1mW/°C above +70°C) | 571mW | Lead Temperature (soldering, 10s) | +300°C |

Stresses beyond those listed under "Absolute Maximum Ratings" may cause permanent damage to the device. These are stress ratings only, and functional operation of the device at these or any other conditions beyond those indicated in the operational sections of the specifications is not implied. Exposure to absolute maximum rating conditions for extended periods may affect device reliability.

DC ELECTRICAL CHARACTERISTICS

($V_{CC} = +3V$, $V_{EE} = 0$, $\overline{DISABLE} = 3V$, $R_L = \infty$, $V_{CM} = 1V$, and $T_A = T_{MIN}$ to T_{MAX} , unless otherwise noted. Typical values are at $T_A = +25^\circ C$.) (Note 1)

| PARAMETER | SYMBOL | CONDITIONS | MIN | TYP | MAX | UNITS |
|----------------------------------------------|-----------------|----------------------------------------------------------|----------------------------------|-----------|-----------------|------------------|
| Operating Supply Voltage Range | | Guaranteed by PSRR test | 2.85 | | 6.5 | V |
| Input Common-Mode Voltage Range | V_{CM} | Guaranteed by CMRR test | V_{EE} | | $V_{CC} - 1.25$ | V |
| Input Offset Voltage | V_{OS} | MAX4_87EU_/MAX4_88EU_/MAX4_8_ES_ | | ± 0.1 | ± 8 | mV |
| | | MAX4285EUT-T/MAX4286EUT-T | | ± 1.5 | ± 12 | |
| Input Offset-Voltage Temperature Coefficient | TC_{VOS} | | | 26 | | $\mu V/^\circ C$ |
| Input Offset-Voltage Matching | ΔV_{OS} | MAX4287/88 and MAX4387/88 | | ± 0.2 | | mV |
| Input Bias Current | I_B | | | 13 | 35 | μA |
| Input Offset Current | I_{OS} | | | 0.2 | 8 | μA |
| Input Resistance | R_{IN} | Differential ($-10mV \leq V_{IN} \leq +10mV$) | | 38 | | k Ω |
| | | Common mode ($V_{EE} \leq V_{CM} \leq V_{CC} - 1.25V$) | | 600 | | |
| Common-Mode Rejection Ratio | CMRR | $V_{EE} \leq V_{CM} \leq V_{CC} - 1.25V$ | MAX4_87EU_/MAX4_88EU_/MAX4_8_ES_ | 50 | 73 | dB |
| | | | MAX4285EUT-T/MAX4286EUT-T | 45 | 68 | |
| Open-Loop Gain | A_{VOL} | $V_{EE} + 0.4V \leq V_{OUT} \leq V_{CC} - 0.4V$ | $R_L = 2k\Omega$ | 75 | 94 | dB |
| | | | $R_L = 300\Omega$ | 65 | 94 | |
| | | | $R_L = 100\Omega$ | 60 | 85 | |

+3V/+5V, 250MHz, SOT23 ADC Buffer Amplifiers with High-Speed Disable

DC ELECTRICAL CHARACTERISTICS (continued)

($V_{CC} = +3V$, $V_{EE} = 0$, $\overline{DISABLE}_- = 3V$, $R_L = \infty$, $V_{CM} = 1V$, and $T_A = T_{MIN}$ to T_{MAX} , unless otherwise noted. Typical values are at $T_A = +25^\circ C$.) (Note 1)

| PARAMETER | SYMBOL | CONDITIONS | | MIN | TYP | MAX | UNITS |
|-------------------------------------------------|------------|---------------------------------------------------------------------|------------------------------------------------|--------------|---------|--------------|---------|
| Output Current Drive | I_{OUT} | $R_L = 20\Omega$ to V_{EE} | | | 77 | | mA |
| | | $R_L = 20\Omega$ to V_{CC} | | | 106 | | |
| Power-Supply Rejection Ratio | PSRR | $V_{CC} = 2.85V$ to $6.5V$ | | 40 | 50 | | dB |
| Disabled Output Leakage Current | I_{LEAK} | $\overline{DISABLE}_- = V_{EE}$, $V_{EE} \leq V_{OUT} \leq V_{CC}$ | | | 700 | | nA |
| $\overline{DISABLE}_-$ Logic Low Threshold | V_{IL} | | | | | $V_{CC} - 2$ | V |
| $\overline{DISABLE}_-$ Logic High Threshold | V_{IH} | | | $V_{CC} - 1$ | | | V |
| $\overline{DISABLE}_-$ Logic Input Low Current | I_{IL} | $\overline{DISABLE}_- = V_{EE}$ | | | ± 3 | ± 22 | μA |
| $\overline{DISABLE}_-$ Logic Input High Current | I_{IH} | $\overline{DISABLE}_- = V_{CC}$ | | | ± 3 | ± 22 | μA |
| Quiescent Supply Current (per Amplifier) | I_{SY} | $V_{CC} = 3V$ | Normal mode | | 20 | 24 | mA |
| | | | Disabled mode, $\overline{DISABLE}_- = V_{EE}$ | | 1 | 3 | |
| | | $V_{CC} = 5V$ | Normal mode | | 23 | 28 | |
| | | | Disabled mode, $\overline{DISABLE}_- = V_{EE}$ | | 1 | 3 | |

MAX4285-MAX4288/MAX4387/MAX4388

+3V/+5V, 250MHz, SOT23 ADC Buffer Amplifiers with High-Speed Disable

AC ELECTRICAL CHARACTERISTICS

($V_{CC} = +3V$, $V_{EE} = 0$, $\overline{DISABLE} = 3V$, $R_L = 300\Omega$ to $V_{CC}/2$, $V_{CM} = 1V$, $A_{vCL} = +1V/V$ for MAX4285/MAX4287/MAX4288, $A_{vCL} = +5V/V$ for MAX4286 and MAX4387/MAX4388, $T_A = +25^\circ C$, unless otherwise noted.)

| PARAMETER | SYMBOL | CONDITIONS | | MIN | TYP | MAX | UNITS |
|--------------------------------|---------------------|----------------------------------------------------------------|-------------------------|-----|-----|-----|-----------------|
| Small-Signal -3dB Bandwidth | BW _{SS} | V _{OUT} = 100mVp-p | MAX4285/87/88 | 250 | | 150 | MHz |
| | | | MAX4286 and MAX4387/88 | | | | |
| Large-Signal -3dB Bandwidth | BW _{LS} | V _{OUT} = 1Vp-p | | 200 | | | MHz |
| Bandwidth for 0.1dB Flatness | BW _{0.1dB} | V _{OUT} = 100mVp-p | MAX4285/87/88 | 100 | | 50 | MHz |
| | | | MAX4286 and MAX4387/88 | | | | |
| Slew Rate | SR | V _{OUT} = 1V step, 10% to 90% | | 350 | | | V/ μ s |
| Rise Time | t _R | V _{OUT} = 1V step, 10% to 90% | | 2.2 | | | ns |
| Fall Time | t _F | V _{OUT} = 1V step, 90% to 10% | | 2.8 | | | ns |
| Settling Time (0.1%) | t _S 0.1% | V _{OUT} = 1V step | MAX4285/87/88 | 6 | | 14 | ns |
| | | | MAX4286 and MAX4387/88 | | | | |
| Overload Recovery Time | | 10% overdrive | | 25 | | | ns |
| Spurious-Free Dynamic Range | SFDR | V _{OUT} = 0.5Vp-p | f _C = 100kHz | 88 | | | dBc |
| | | | f _C = 1MHz | 88 | | | |
| | | | f _C = 5MHz | 87 | | | |
| | | | f _C = 10MHz | 79 | | | |
| | | | f _C = 20MHz | 70 | | | |
| | | | f _C = 60MHz | 50 | | | |
| Two-Tone Third-Order Intercept | IP ³ | f _C = 20MHz | | 34 | | | dBm |
| Input Noise Voltage Density | e _n | f = 1MHz | | 10 | | | nV/ \sqrt{Hz} |
| Input Noise Current Density | i _n | f = 1MHz | | 2.1 | | | pA/ \sqrt{Hz} |
| Input Capacitance | C _{IN} | | | 2 | | | pF |
| Output Impedance | Z _{OUT} | f = 10MHz | | 0.5 | | | Ω |
| Enable Time | t _{ON} | V _{OUT} = 1V, to within 0.1% | | 40 | | 50 | ns |
| Disable Time | t _{OFF} | V _{OUT} = 1V, to within 0.1% | | | | | |
| Crosstalk | X _{TALK} | MAX4287/88 and MAX4387/88, f = 10MHz, V _{OUT} = 1Vp-p | | 85 | | | dBc |

+3V/+5V, 250MHz, SOT23 ADC Buffer Amplifiers with High-Speed Disable

MAX4285-MAX4288/MAX4387/MAX4388

AC ELECTRICAL CHARACTERISTICS (continued)

(V_{CC} = +5V, V_{EE} = 0, $\overline{\text{DISABLE}} = 5V$, R_L = 300Ω to V_{CC}/2, V_{CM} = 2.5V, A_{VCL} = +1V/V for MAX4285/MAX4287/MAX4288, A_{VCL} = +5V/V for MAX4286 and MAX4387/MAX4388, T_A = +25°C, unless otherwise noted.)

| PARAMETER | SYMBOL | CONDITIONS | | MIN | TYP | MAX | UNITS |
|--------------------------------|---------------------|----------------------------------------------------------------|-------------------------|-----|-----|--------|-------|
| Small-Signal -3dB Bandwidth | BW _{SS} | V _{OUT} = 100mVp-p | MAX4285/87/88 | 220 | | MHz | |
| | | | MAX4286 and MAX4387/88 | 130 | | | |
| Large-Signal -3dB Bandwidth | BW _{LS} | V _{OUT} = 1Vp-p | | 195 | | MHz | |
| Bandwidth for 0.1dB Flatness | BW _{0.1dB} | V _{OUT} = 100mVp-p | MAX4285/87/88 | 75 | | MHz | |
| | | | MAX4286 and MAX4387/88 | 40 | | | |
| Slew Rate | SR | V _{OUT} = 2V step, 10% to 90% | | 385 | | V/μs | |
| Rise Time | t _R | V _{OUT} = 2V step, 10% to 90% | | 4.2 | | ns | |
| Fall Time | t _F | V _{OUT} = 2V step, 90% to 10% | | 2.9 | | ns | |
| Settling Time (0.1%) | t _{S 0.1%} | V _{OUT} = 2V step | MAX4285/87/88 | 8 | | ns | |
| | | | MAX4286 and MAX4387/88 | 10 | | | |
| Spurious-Free Dynamic Range | SFDR | V _{OUT} = 1Vp-p | f _C = 100kHz | 86 | | dBc | |
| | | | f _C = 1MHz | 86 | | | |
| | | | f _C = 5MHz | 86 | | | |
| | | | f _C = 10MHz | 77 | | | |
| | | | f _C = 20MHz | 64 | | | |
| | | | f _C = 60MHz | 45 | | | |
| Two-Tone Third-Order Intercept | IP3 | f _C = 20MHz | | 40 | | dBm | |
| Input Noise Voltage Density | e _n | f = 1MHz | | 6.5 | | nV/√Hz | |
| Input Noise Current Density | i _n | f = 1MHz | | 1.9 | | pA/√Hz | |
| Input Capacitance | C _{IN} | | | 2 | | pF | |
| Output Impedance | Z _{OUT} | f = 10MHz | | 0.5 | | Ω | |
| Enable Time | t _{ON} | V _{OUT} = 1V, to within 0.1% | | 40 | | ns | |
| Disable Time | t _{OFF} | V _{OUT} = 1V, to within 0.1% | | 35 | | | |
| Crosstalk | X _{TALK} | MAX4287/88 and MAX4387/88, f = 10MHz, V _{OUT} = 2Vp-p | | 85 | | dBc | |

Note 1: The MAX428_EUT (SOT23) are 100% production tested at T_A = +25°C. Specifications over temperature limits are guaranteed by design.

+3V/+5V, 250MHz, SOT23 ADC Buffer Amplifiers with High-Speed Disable

Typical Operating Characteristics

($V_{CC} = +3V$, $V_{EE} = 0$, $\overline{DISABLE} \geq 2V$, $R_L = 300\Omega$ to $V_{CC}/2$, $V_{CM} = +1.0V$, $T_A = +25^\circ C$, unless otherwise noted.)

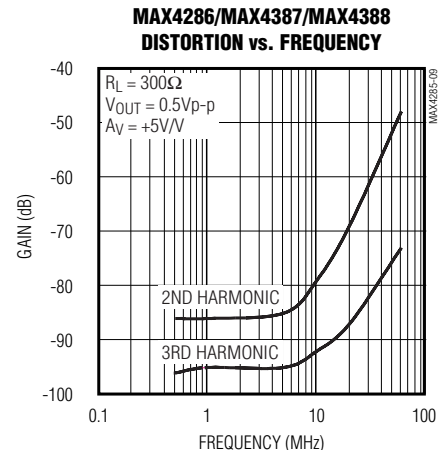
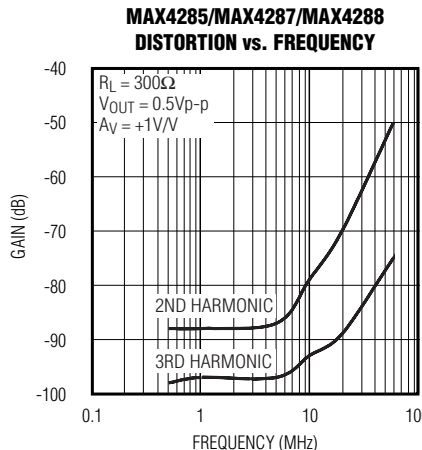
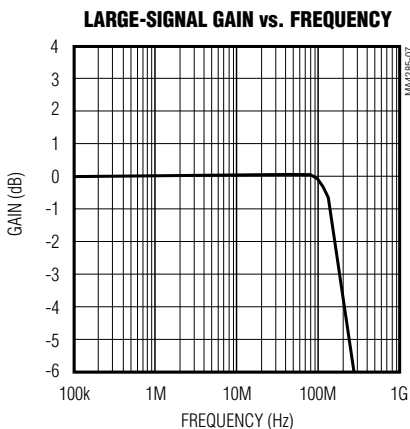
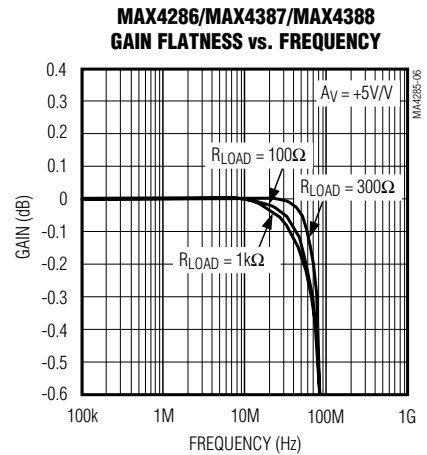
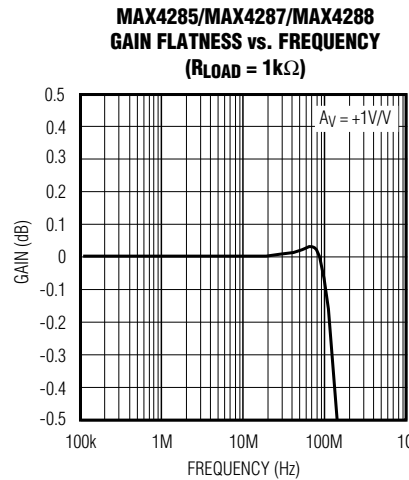
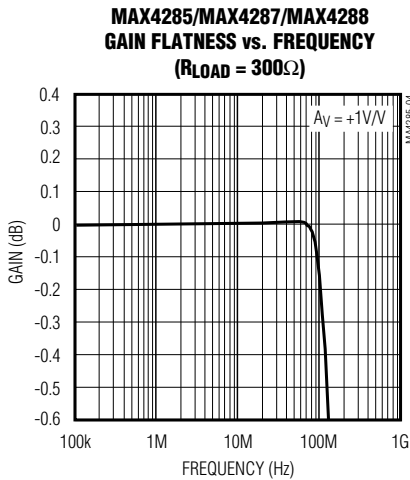
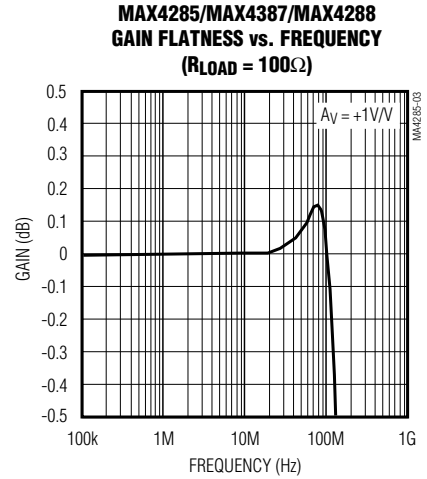
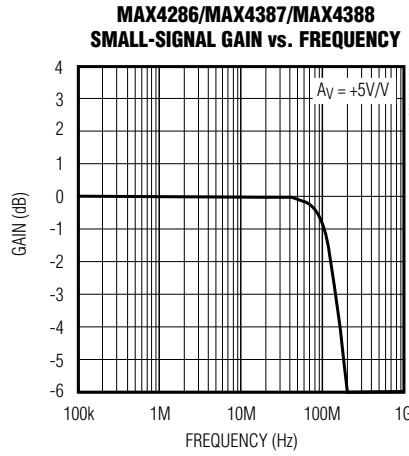
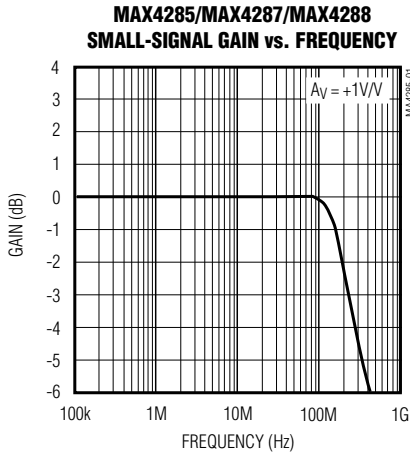

+3V/+5V, 250MHz, SOT23 ADC Buffer Amplifiers with High-Speed Disable

Typical Operating Characteristics (continued)

($V_{CC} = +3V$, $V_{EE} = 0$, $\overline{DISABLE} \geq 2V$, $R_L = 300\Omega$ to $V_{CC}/2$, $V_{CM} = +1.0V$, $T_A = +25^\circ C$, unless otherwise noted.)

MAX4285-MAX4288/MAX4387/MAX4388

**MAX4285/MAX4287/MAX4288
DISTORTION vs. LOAD**

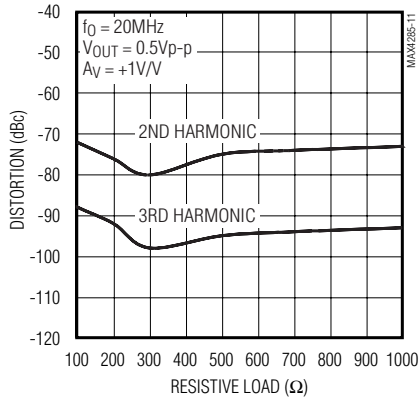

**MAX4286/MAX4387/MAX4388
DISTORTION vs. LOAD**

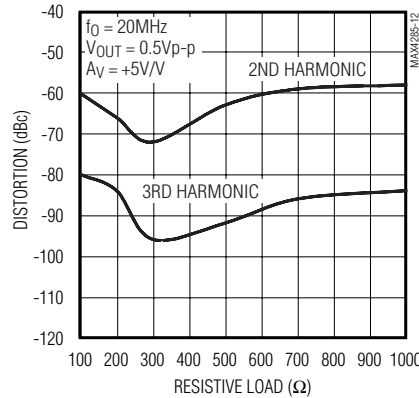

**MAX4285/MAX4287/MAX4288
DISTORTION vs. SWING**

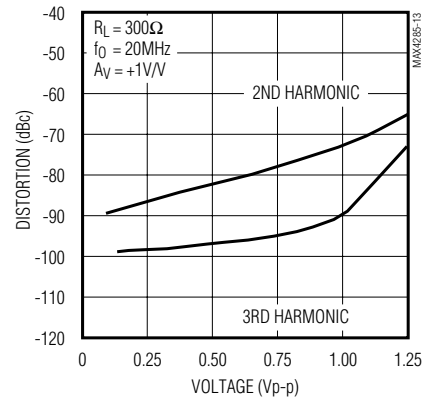

**MAX4286/MAX4387/MAX4388
DISTORTION vs. SWING**

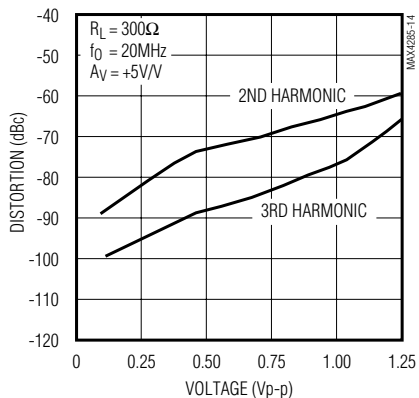

**MAX4285/MAX4286/MAX4288/MAX4388
OFF-ISOLATION vs. FREQUENCY**

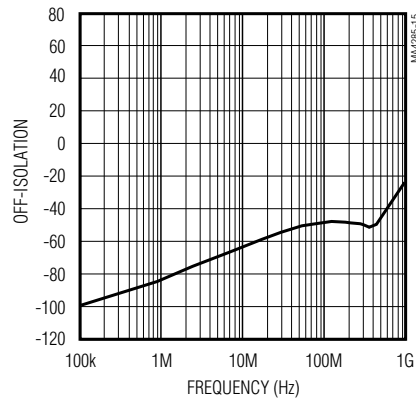

**MAX4287/MAX4288/MAX4387/MAX4388
CROSSTALK vs. FREQUENCY**

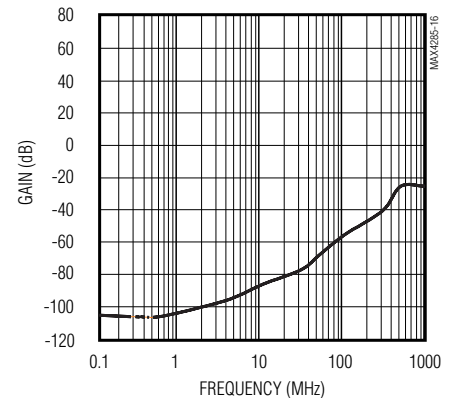

**MAX4285/MAX4287/MAX4288
LARGE-SIGNAL PULSE RESPONSE
($A_V = +1\text{V/V}$)**

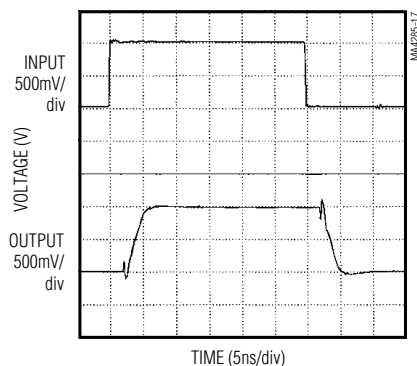

**MAX4286/MAX4387/MAX4388
LARGE-SIGNAL PULSE RESPONSE
($A_V = +5\text{V/V}$)**

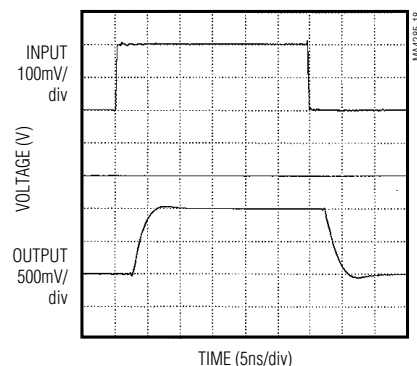

+3V/+5V, 250MHz, SOT23 ADC Buffer Amplifiers with High-Speed Disable

Typical Operating Characteristics (continued)

($V_{CC} = +3V$, $V_{EE} = 0$, $\overline{DISABLE} \geq 2V$, $R_L = 300\Omega$ to $V_{CC}/2$, $V_{CM} = +1.0V$, $T_A = +25^\circ C$, unless otherwise noted.)

**MAX4285/MAX4287/MAX4288
SMALL-SIGNAL PULSE RESPONSE
($A_V = +1V/V$)**

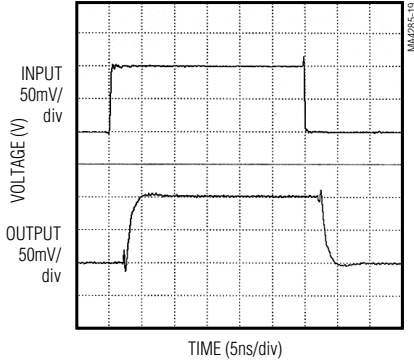

**MAX4286/MAX4387/MAX4388
SMALL-SIGNAL PULSE RESPONSE
($A_V = +5V/V$)**

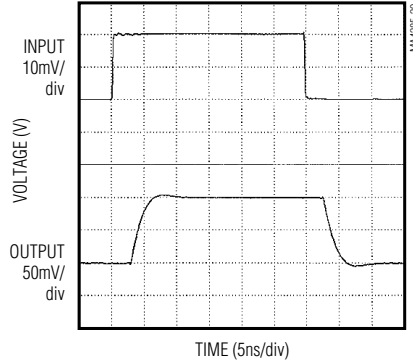

**MAX4285/MAX4287/MAX4288
SMALL-SIGNAL PULSE RESPONSE
($C_{LOAD} = 22pF$, $A_V = +1V/V$)**

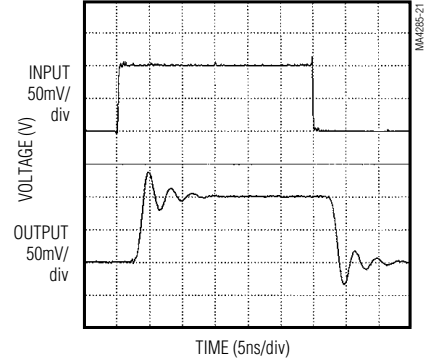

**MAX4286/MAX4387/MAX4388
SMALL-SIGNAL PULSE RESPONSE
($C_{LOAD} = 47pF$, $A_V = +5V/V$)**

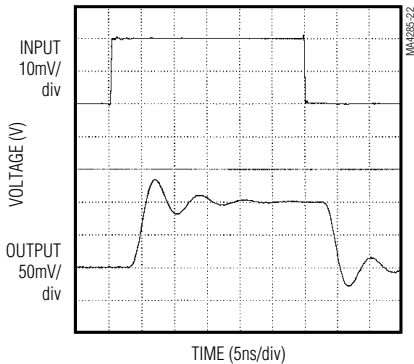

**ISOLATION RESISTANCE
vs. LOAD CAPACITANCE**

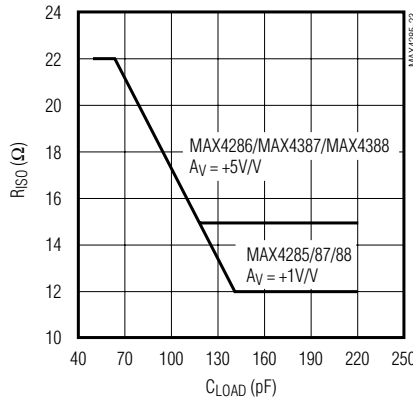

GROUP DELAY vs. FREQUENCY

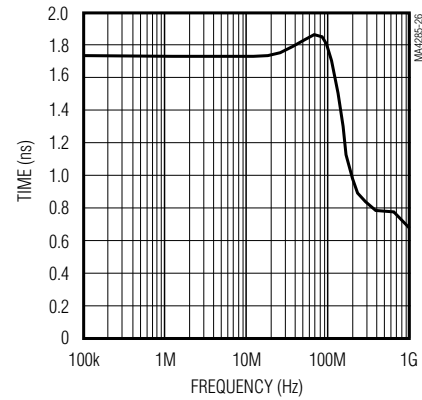

**POWER-SUPPLY REJECTION RATIO
vs. FREQUENCY**

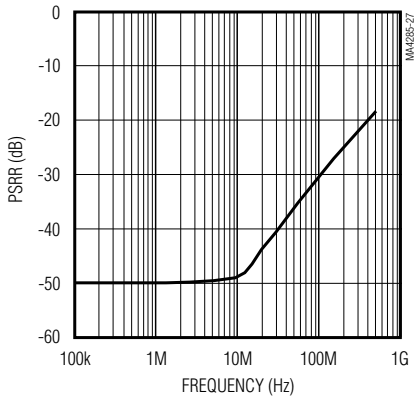

**COMMON-MODE REJECTION
vs. FREQUENCY**

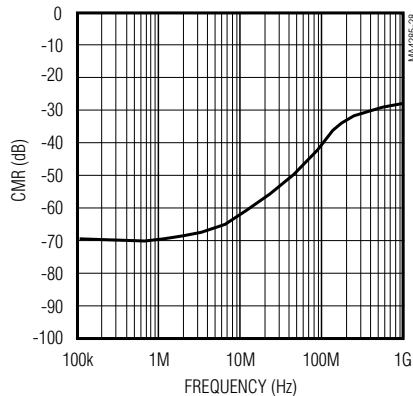

OUTPUT IMPEDANCE vs. FREQUENCY

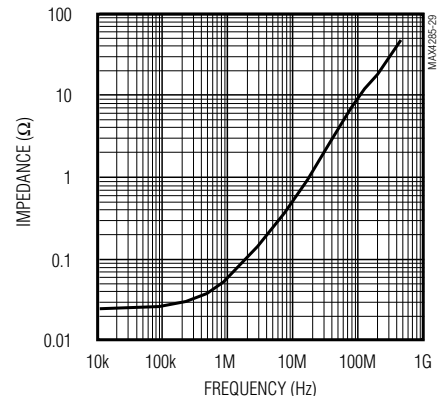

+3V/+5V, 250MHz, SOT23 ADC Buffer Amplifiers with High-Speed Disable

Typical Operating Characteristics (continued)

($V_{CC} = +3V$, $V_{EE} = 0$, $\overline{DISABLE}_\geq 2V$, $R_L = 300\Omega$ to $V_{CC}/2$, $V_{CM} = +1.0V$, $T_A = +25^\circ C$, unless otherwise noted.)

MAX4285-MAX4288/MAX4387/MAX4388

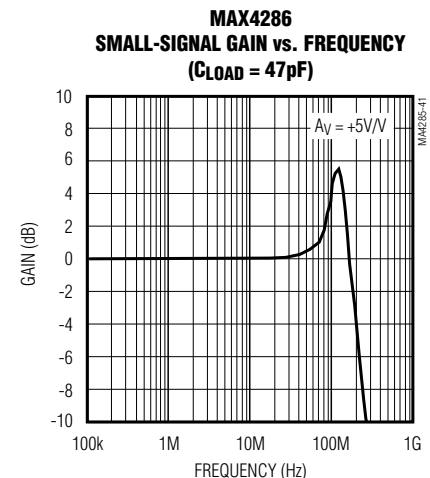
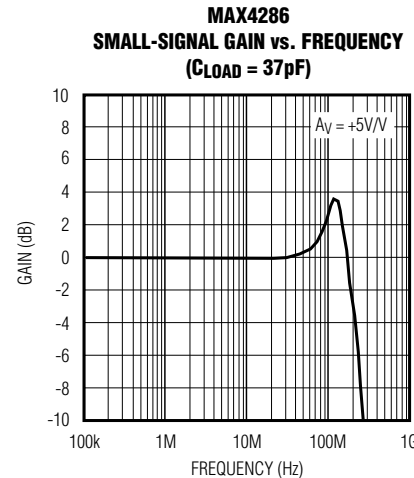
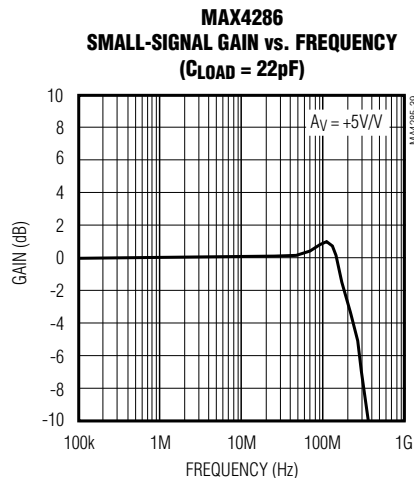
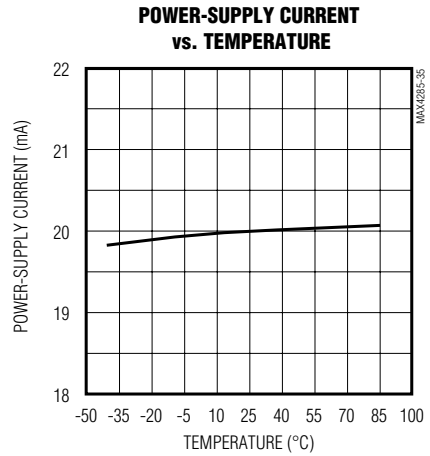
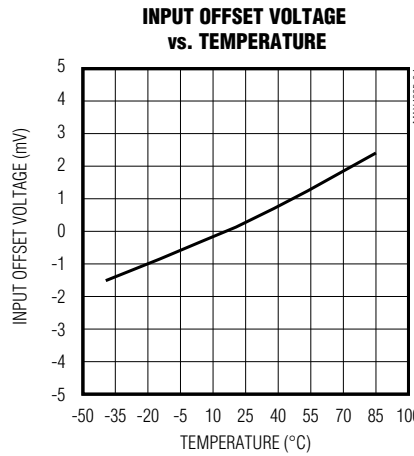
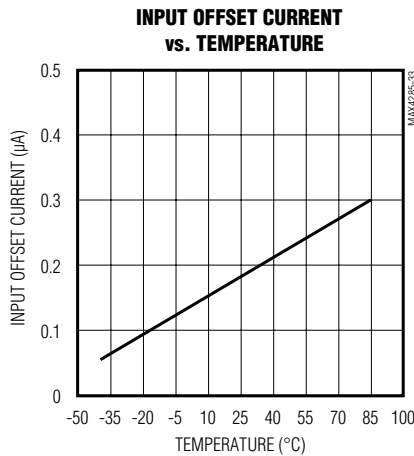
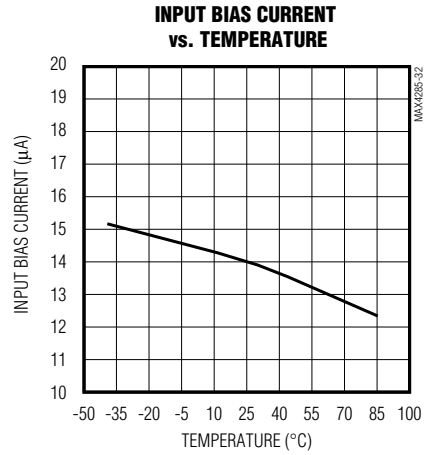
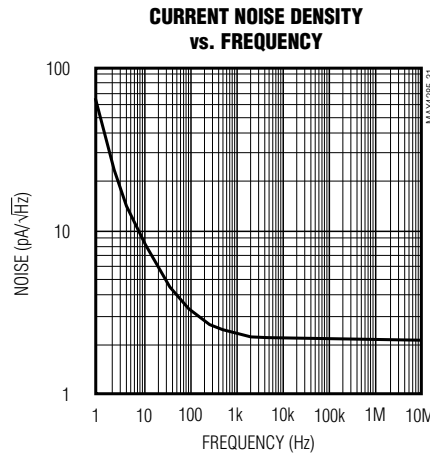
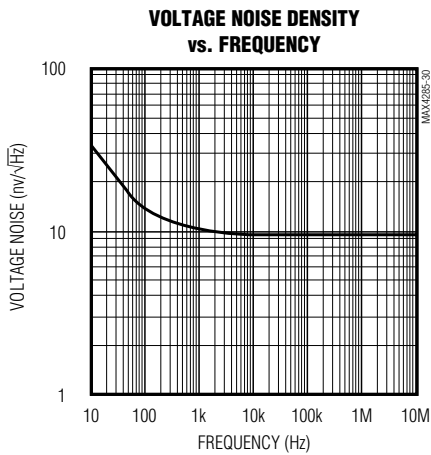

+3V/+5V, 250MHz, SOT23 ADC Buffer Amplifiers with High-Speed Disable

Typical Operating Characteristics (continued)

($V_{CC} = +3V$, $V_{EE} = 0$, $\overline{DISABLE} \geq 2V$, $R_L = 300\Omega$ to $V_{CC}/2$, $V_{CM} = +1.0V$, $T_A = +25^\circ C$, unless otherwise noted.)

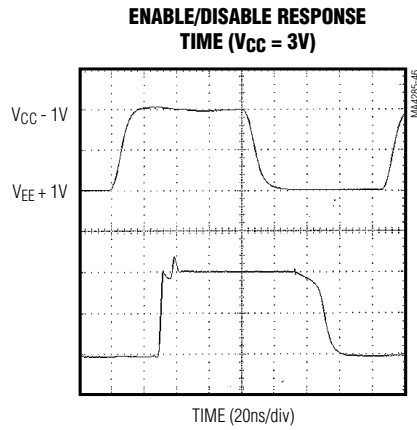
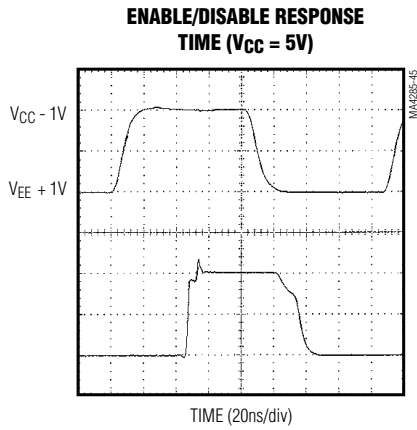
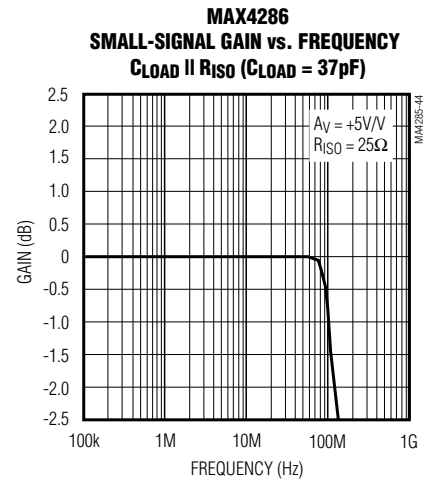
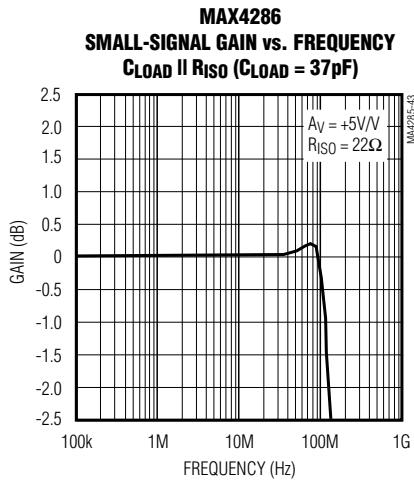
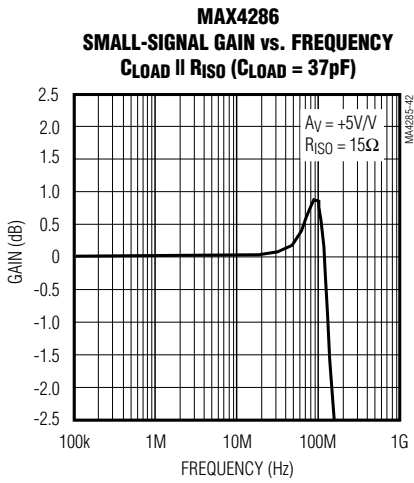

+3V/+5V, 250MHz, SOT23 ADC Buffer Amplifiers with High-Speed Disable

Pin Description

| PIN | | | | | NAME | FUNCTION |
|--------------------|-------------|--------------------|--------------------|--------------|------------------------------|-------------------------------------------------------------------|
| MAX4285 MAX4286 | | MAX4287 MAX4387 | MAX4288 MAX4388 | | | |
| 6-PIN SOT23-6 | 8-PIN SO | 8-PIN μMAX/SO | 10-PIN μMAX | 14-PIN SO | | |
| — | 1, 5 | — | — | 5, 7, 8, 10 | N.C. | Not Internally Connected. Connect to ground or leave unconnected. |
| 1 | 6 | — | — | — | OUT | Amplifier Output |
| 2 | 4 | 4 | 4 | 4 | V _{EE} | Negative Power Supply, or Ground in Single-Supply Operation |
| 3 | 3 | — | — | — | IN+ | Noninverting Input |
| 4 | 2 | — | — | — | IN- | Inverting Input |
| 5 | 8 | — | — | — | $\overline{\text{DISABLE}}$ | Disable (active low) |
| — | — | — | 5 | 6 | $\overline{\text{DISABLEA}}$ | Disable Amplifier A (active low) |
| — | — | — | 6 | 9 | $\overline{\text{DISABLEB}}$ | Disable Amplifier B (active low) |
| 6 | 7 | 8 | 10 | 14 | V _{CC} | Positive Power Supply |
| — | — | 1 | 1 | 1 | OUTA | Amplifier A Output |
| — | — | 2 | 2 | 2 | INA- | Amplifier A Inverting Input |
| — | — | 3 | 3 | 3 | INA+ | Amplifier A Noninverting Input |
| — | — | 5 | 7 | 11 | INB+ | Amplifier B Noninverting Input |
| — | — | 6 | 8 | 12 | INB- | Amplifier B Inverting Input |
| — | — | 7 | 9 | 13 | OUTB | Amplifier B Output |

Detailed Description

The MAX4285–MAX4288 and MAX4387/MAX4388 are voltage-feedback op amps, intended for use as ADC input buffers. They operate from a single +2.85V to +6.5V supply or dual $\pm 1.425\text{V}$ to $\pm 3.25\text{V}$ supplies. Their high output drive, wide bandwidth, fast settling, low noise, and low distortion make them ideal for the brutal task of meeting the dynamic input drive requirements of high-speed ADCs or other demanding applications.

The MAX4285/MAX4286/MAX4288 and MAX4388 have a high-speed disable mode that places the outputs in a high-impedance state and lowers operating supply current to 1mA. The enable time is typically 40ns, and the disable time is typically 50ns. The MAX4285/MAX4286 have a single enable pin ($\overline{\text{DISABLE}}$), and the MAX4288/

MAX4388 have dual disable pins ($\overline{\text{DISABLEA}}$, $\overline{\text{DISABLEB}}$).

The MAX4285/MAX4287/MAX4288 are internally compensated for unity-gain stability. The MAX4286/MAX4387/MAX4388 are compensated for gains of +5V/V or greater.

Applications Information

Inverting and Noninverting Configurations

Select the gain-setting feedback (R_F) and input (R_G) resistor values considering the following criteria: large resistor values increase voltage noise and interact with the amplifier's input and PC board capacitance to effect system bandwidth. This generates undesirable poles and zeros that decrease bandwidth or cause oscillations.

MAX4285–MAX4288/MAX4387/MAX4388

+3V/+5V, 250MHz, SOT23 ADC Buffer Amplifiers with High-Speed Disable

For example, a noninverting gain-of-two configuration ($R_F = R_G$) using $1k\Omega$ resistors, combined with $2pF$ typical amplifier input capacitance, generates a pole at $159MHz$. Since this pole is within the amplifier bandwidth, it jeopardizes stability. Reducing these $1k\Omega$ resistors to 100Ω extends the pole frequency to $1.59GHz$, but affects output swing by adding 200Ω in parallel with the amplifier's load resistor. The typical value for R_F is 300Ω .

Layout and Power-Supply Bypassing

These amplifiers operate from a single $+2.85V$ to $+6.5V$ power supply or from $\pm 1.425V$ to $\pm 3.25V$ dual supplies. For single-supply operation, bypass V_{CC} to ground with a $0.1nF$ capacitor as close to the pin as possible, with a $0.1\mu F$ capacitor in parallel. If operating with dual supplies, bypass each supply with capacitors to ground.

Observe the following guidelines:

- A solid ground plane is essential for good high-frequency behavior.
- Where possible, use multiple ground vias.
- Use a PC board with at least two layers. Avoid areas of unreferenced copper-clad.
- Keep signal traces as short and as straight as possible. Do not make sharp turns; round all trace corners.
- Use a constant-impedance board design if possible.

High-Speed Disable

The MAX4285/MAX4286/MAX4288 and MAX4388 feature a disable ($\overline{DISABLE}$) input that places the amplifier in a low-power, high-output-impedance state. When $\overline{DISABLE}$ is asserted, the amplifier's output impedance is typically $35k\Omega$. This high output impedance, combined with the low $2pF$ output capacitance, make these devices ideal for ADC input multiplexing applications or switch applications. Typical enable/disable times are $40ns/50ns$.

Output Capacitive Loading and Stability

These op amps are optimized for AC performance. They are not designed to drive highly reactive loads, which decrease phase margin and may produce excessive ringing and oscillation. A small isolation resistor (usually 20Ω to 30Ω) placed before the reactive load reduces possible ringing and oscillation (Figure 1). At higher capacitive loads, AC performance is dependent on the interaction of the load capacitance, the isolation resistor, and on-board layout.

Output Drive Capability

The MAX4285-MAX4288 and MAX4387/MAX4388 have an output sink capability of $106mA$ and a source capability of $77mA$. This high current ability allows them to drive low-impedance and dynamic-impedance ADC inputs. The linear output range of these devices is ($V_{EE} + 0.4V$) to ($V_{CC} - 0.4V$). Operation beyond this range is not recommended due to reduced gain and phase margin.

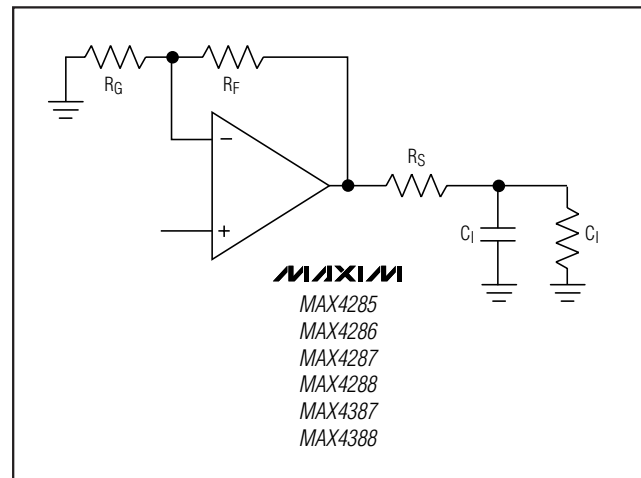

Figure 1. Using an Isolation Resistor (R_S) for High Capacitive Loads

+3V/+5V, 250MHz, SOT23 ADC Buffer Amplifiers with High-Speed Disable

Ordering Information (continued)

| PART | TEMP. RANGE | PIN-PACKAGE | SOT TOP MARK |
|------------|----------------|--------------|--------------|
| MAX4288EUB | -40°C to +85°C | 10 μ MAX | — |
| MAX4288ESD | -40°C to +85°C | 14 SO | — |
| MAX4387EUA | -40°C to +85°C | 8 μ MAX | — |
| MAX4387ESA | -40°C to +85°C | 8 SO | — |
| MAX4388EUB | -40°C to +85°C | 10 μ MAX | — |
| MAX4388ESD | -40°C to +85°C | 14 SO | — |

Chip Information

TRANSISTOR COUNT: MAX4285/MAX4286 : 114
 MA4287/MAX4288/
 MAX4387/MAX4388 : 227

Typical Operating Circuit

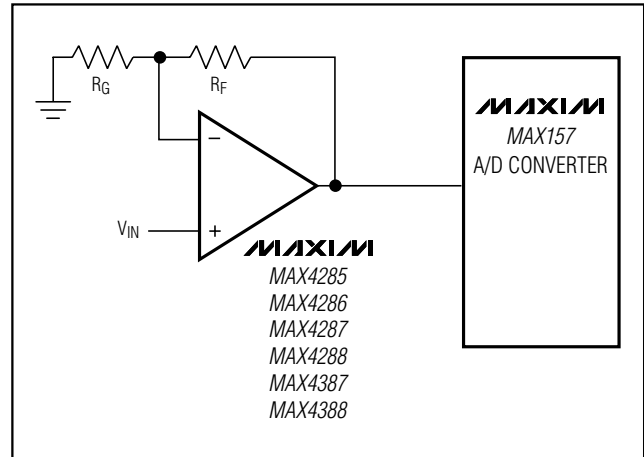

Pin Configurations

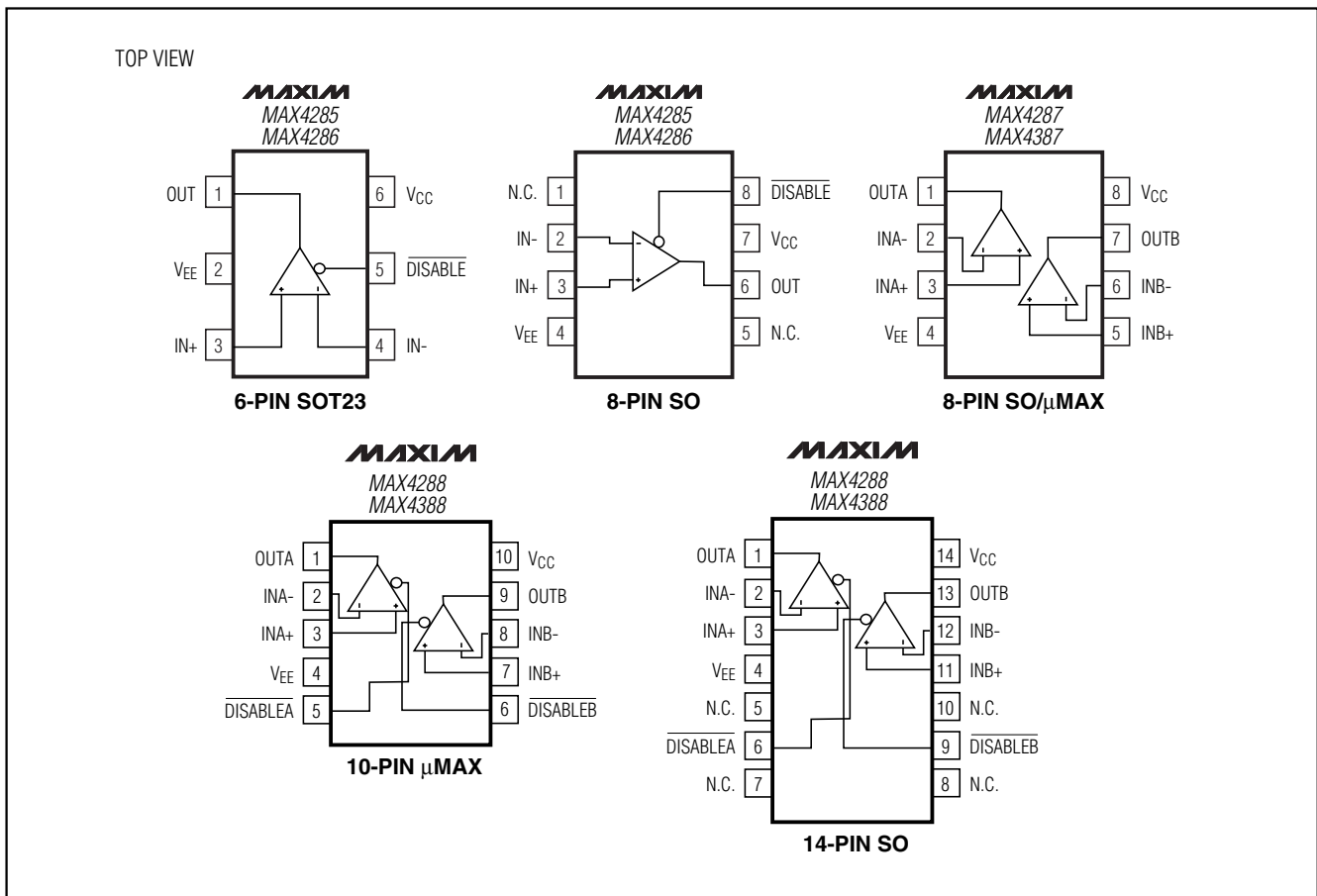

MAX4285-MAX4288/MAX4387/MAX4388

+3V/+5V, 250MHz, SOT23 ADC Buffer Amplifiers with High-Speed Disable

Package Information

SEE NOTE 5
EXAMPLE
TOP MARK

PIN 1
I.D. DOT
(SEE NOTE 6)

PIN #1

NOTE:

- ALL DIMENSIONS ARE IN MILLIMETERS.
- FOOT LENGTH MEASURED AT INTERCEPT POINT BETWEEN DATUM "A" & LEAD SURFACE.
- PACKAGE OUTLINE EXCLUSIVE OF MOLD FLASH & METAL BURR.
- PACKAGE OUTLINE INCLUSIVE OF SOLDER PLATING.
- PIN 1 IS LOWER LEFT PIN WHEN READING TOP MARK FROM LEFT TO RIGHT. (SEE EXAMPLE TOP MARK)
- PIN 1 I.D. DOT IS 0.3 MM Ø MIN. LOCATED ABOVE PIN 1.

| SYMBOL | MIN | MAX |
|--------|------|----------|
| A | 0.90 | 1.45 |
| A1 | 0.00 | 0.15 |
| A2 | 0.90 | 1.30 |
| b | 0.35 | 0.50 |
| c | 0.08 | 0.20 |
| D | 2.80 | 3.00 |
| E | 2.60 | 3.00 |
| E1 | 1.50 | 1.75 |
| L | 0.35 | 0.55 |
| e | | 0.95 REF |
| α | 0° | 10° |

6LSOT23

MAXIM

PROPRIETARY INFORMATION

TITLE:
PACKAGE OUTLINE, SOT23, 6L

APPROVAL: _____ DOCUMENT CONTROL NO. 21-0058 REV. 1/1

TOP VIEW

BOTTOM VIEW

FRONT VIEW

SIDE VIEW

EXPOSED PAD (Note 5)

EXPOSED PAD (Note 5)

| | INCHES | | MILLIMETERS | | JEDEC | | | |
|----|--------|-------|-------------|-------|--------|-------|------|------|
| | MIN | MAX | MIN | MAX | MIN | MAX | MIN | MAX |
| A | 0.037 | 0.043 | 0.94 | 1.10 | --- | 0.043 | --- | 1.10 |
| A1 | 0.002 | 0.006 | 0.05 | 0.15 | 0.002 | 0.006 | 0.05 | 0.15 |
| B | 0.010 | 0.014 | 0.25 | 0.36 | 0.010 | 0.016 | 0.25 | 0.40 |
| C | 0.005 | 0.007 | 0.13 | 0.18 | 0.005 | 0.009 | 0.13 | 0.23 |
| D | 0.116 | 0.120 | 2.95 | 3.05 | 0.114 | 0.122 | 2.9 | 3.1 |
| e | 0.0256 | BSC | 0.65 | BSC | 0.0256 | BSC | 0.64 | BSC |
| E | 0.116 | 0.120 | 2.95 | 3.05 | 0.114 | 0.122 | 2.9 | 3.1 |
| H | 0.188 | 0.198 | 4.78 | 5.03 | 0.193 | BSC | 4.9 | BSC |
| L | 0.016 | 0.026 | 0.41 | 0.66 | 0.016 | 0.027 | 0.40 | 0.70 |
| α | 0° | 6° | 0° | 6° | 0° | 6° | 0° | 6° |
| *X | 0.087 | 0.099 | 2.210 | 2.515 | | | | |
| *Y | 0.062 | 0.074 | 1.575 | 1.880 | | | | |

* EXPOSED PAD (Note 5)

8LUMAXD BFC

MAXIM

PROPRIETARY INFORMATION

TITLE:
PACKAGE OUTLINE, 8L UMAX WITH EP OPTION

APPROVAL: _____ DOCUMENT CONTROL NO. 21-0036 REV. H 1/1

NOTES:

- D&E DO NOT INCLUDE MOLD FLASH.
- MOLD FLASH OR PROTRUSIONS NOT TO EXCEED .15 MM (.006").
- CONTROLLING DIMENSION: MILLIMETERS.
- MEETS JEDEC MO-187.
- DIMENSIONS X & Y APPLY TO EXPOSED PAD (EP) VERSIONS ONLY. SEE INDIVIDUAL PRODUCT DATASHEET TO DETERMINE IF A PRODUCT USES EXPOSED PAD PACKAGE.
- EXPOSED PAD FLUSH WITH BOTTOM OF PACKAGE WITHIN .002".

+3V/+5V, 250MHz, SOT23 ADC Buffer Amplifiers with High-Speed Disable

Package Information (continued)

MAX4285-MAX4288/MAX4387/MAX4388

10LUMAX.EPS

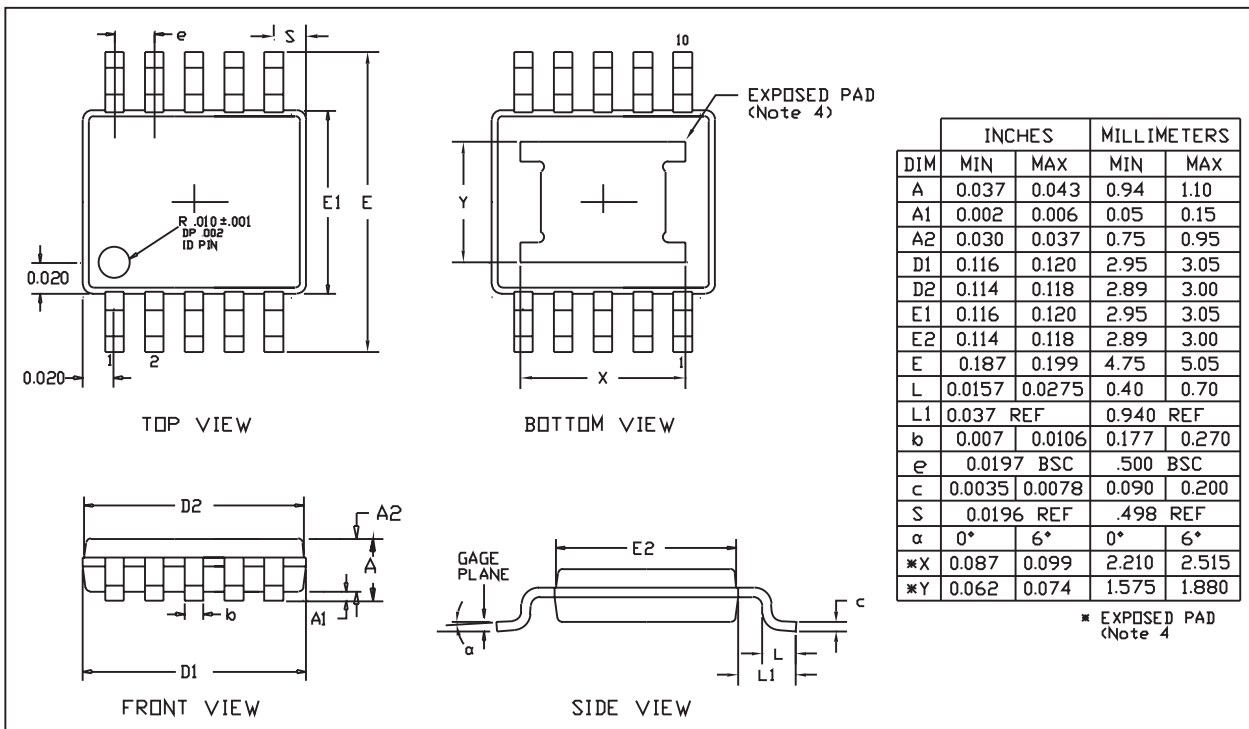

- NOTES:
1. D&E DO NOT INCLUDE MOLD FLASH.
 2. MOLD FLASH OR PROTRUSIONS NOT TO EXCEED .15 MM (.006").
 3. CONTROLLING DIMENSION: MILLIMETERS.
 4. DIMENSIONS X & Y APPLY TO EXPOSED PAD (EP) VERSIONS ONLY. SEE INDIVIDUAL PRODUCT DATASHEET TO DETERMINE IF A PRODUCT USES EXPOSED PAD PACKAGE.
 5. EXPOSED PAD FLUSH WITH BOTTOM OF PACKAGE WITHIN .002".

MAXIM

PROPRIETARY INFORMATION

TITLE: PACKAGE OUTLINE, 10L UMAX WITH EP OPTION

| | | |
|----------|----------------------|-------|
| APPROVAL | DOCUMENT CONTROL NO. | REV |
| | 21-0061 | F 1/1 |

+3V/+5V, 250MHz, SOT23 ADC Buffer Amplifiers with High-Speed Disable

Package Information (continued)

| | INCHES | | MILLIMETERS | |
|----|--------|-------|-------------|------|
| | MIN | MAX | MIN | MAX |
| A | 0.053 | 0.069 | 1.35 | 1.75 |
| A1 | 0.004 | 0.010 | 0.10 | 0.25 |
| B | 0.014 | 0.019 | 0.35 | 0.49 |
| C | 0.007 | 0.010 | 0.19 | 0.25 |
| e | 0.050 | | 1.27 | |
| E | 0.150 | 0.157 | 3.80 | 4.00 |
| H | 0.228 | 0.244 | 5.80 | 6.20 |
| h | 0.010 | 0.020 | 0.25 | 0.50 |
| L | 0.016 | 0.050 | 0.40 | 1.27 |

| | INCHES | | MILLIMETERS | | N | MS012 |
|---|--------|-------|-------------|-------|----|-------|
| | MIN | MAX | MIN | MAX | | |
| D | 0.189 | 0.197 | 4.80 | 5.00 | 8 | A |
| D | 0.337 | 0.344 | 8.55 | 8.75 | 14 | B |
| D | 0.386 | 0.394 | 9.80 | 10.00 | 16 | C |

NOTES:
 1. D&E DO NOT INCLUDE MOLD FLASH
 2. MOLD FLASH OR PROTRUSIONS NOT TO EXCEED .15mm (.006")
 3. LEADS TO BE COPLANAR WITHIN .102mm (.004")
 4. CONTROLLING DIMENSION: MILLIMETER
 5. MEETS JEDEC MS012-XX AS SHOWN IN ABOVE TABLE
 6. N = NUMBER OF PINS

120 SAN GABRIEL DR. SUNNYVALE CA 94086 FAX 408 737 7754
 PROPRIETARY INFORMATION

PACKAGE FAMILY OUTLINE: SOT23 .150" $\frac{1}{1}$ 21-0041 A
 TITLE DOCUMENT CONTROL NUMBER REV

Maxim cannot assume responsibility for use of any circuitry other than circuitry entirely embodied in a Maxim product. No circuit patent licenses are implied. Maxim reserves the right to change the circuitry and specifications without notice at any time.

16 **Maxim Integrated Products, 120 San Gabriel Drive, Sunnyvale, CA 94086 408-737-7600**