

1.0V Micropower, SOT23, Operational Amplifier

General Description

The MAX4289 micropower, operational amplifier is optimized for ultra-low supply voltage operation. The amplifier consumes only 9 μ A of quiescent supply current and is fully specified for operation from a single 1.0V to 5.5V power supply. This ultra-low voltage operation together with the low quiescent current consumption make the MAX4289 ideal for use in battery-powered systems operated from as little as a single alkaline cell. The MAX4289 also features a wide input common-mode range that includes the ground, and an output voltage swing that is virtually Rail-to-Rail[®], allowing almost all of the power supply to be used for signal voltage.

The low input offset voltage and low input bias current specifications along with the high open-loop gain make the MAX4289 well-suited to applications requiring a high degree of precision.

The MAX4289 is available in a tiny 6-pin SOT23 package. All specifications are guaranteed over the extended temperature range of -40°C to +85°C.

Applications

Single-Cell Systems	Strain Gauges
Portable Electronic Equipment	Cellular Phones
Battery-Powered Instrumentation	Notebook Computers
Hearing Aids Using Zinc Air Battery	Sensor Amplifiers
	Portable Communication Devices

Typical Operating Characteristic

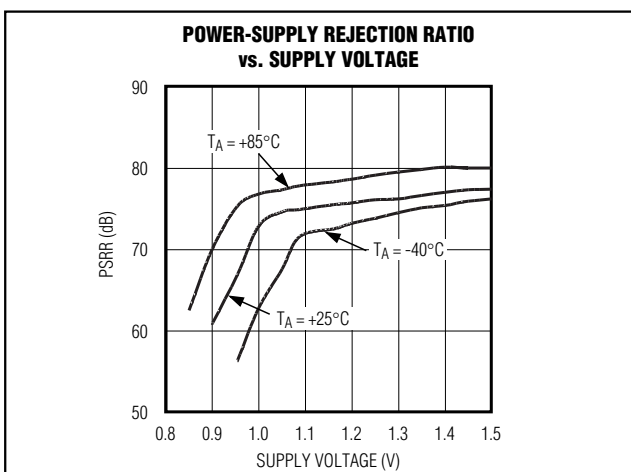

Rail-to-Rail is a registered trademark of Nippon Motorola, Ltd.

Features

- ◆ Ultra-Low Voltage Operation: Guaranteed Specifications from 1.0V to 5.5V
- ◆ Input Common-Mode Range: 0 to ($V_{CC} - 0.2V$)
- ◆ Ultra-Low Power Consumption: 9 μ A Supply Current (typ)
- ◆ Optimized for Operation from Single-Cell Battery-Powered Systems
- ◆ Compatible with 3.0V and 5.0V Single-Supply Systems
- ◆ Low Offset Voltage: 0.2mV
- ◆ Low Input Bias Current: 5nA
- ◆ High Open-Loop Voltage Gain: 90dB
- ◆ Rail-to-Rail Output Stage Drives 5k Ω Load
- ◆ No Output Phase Reversal for Overdriven Inputs
- ◆ Available in a Tiny 6-Pin SOT23 (3mm \times 3mm)

Ordering Information

PART	TEMP RANGE	PIN-PACKAGE	TOP MARK
MAX4289EUT-T	-40°C to +85°C	6 SOT23-6	AARX
MAX4289ESA	-40°C to +85°C	8 SO	—

Pin Configurations

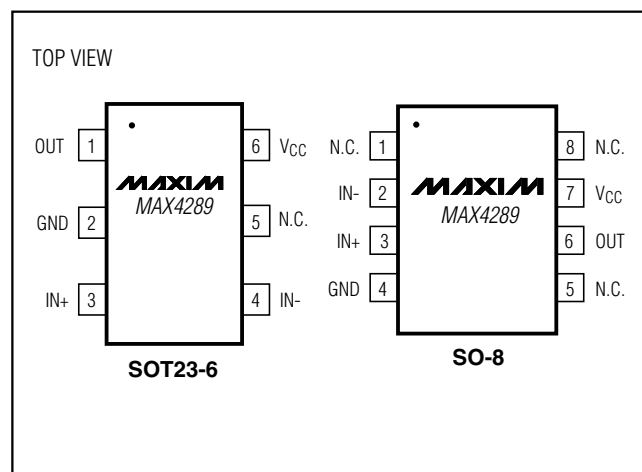

1.0V Micropower, SOT23, Operational Amplifier

ABSOLUTE MAXIMUM RATINGS

Power-Supply Voltage (V_{CC} to GND).....6V	Operating Temperature Range-40°C to +85°C
Input Voltage (IN+ or IN-)($V_{CC} + 0.3V$) to -0.3V	Junction Temperature+150°C
Input Current (IN+ or IN-).....20mA	Storage Temperature Range-65°C to +150°C
Output Short-Circuit Duration to V_{CC} or GNDContinuous	Lead Temperature (soldering, 10s)+300°C
Continuous Power Dissipation ($T_A = +70^\circ\text{C}$)	
6-Pin SOT23 (derate 8.7mW/°C above +70°C).....696mW	
8-Pin SO (derate 5.88mW/°C above +70°C).....471mW	

Stresses beyond those listed under "Absolute Maximum Ratings" may cause permanent damage to the device. These are stress ratings only, and functional operation of the device at these or any other conditions beyond those indicated in the operational sections of the specifications is not implied. Exposure to absolute maximum rating conditions for extended periods may affect device reliability.

ELECTRICAL CHARACTERISTICS

($V_{CC} = 3V$, $V_{CM} = 0$, $V_{OUT} = V_{CC}/2$, R_L tied to $V_{CC}/2$, $T_A = T_{MIN}$ to T_{MAX} , unless otherwise noted. Typical values are at $T_A = +25^\circ\text{C}$.) (Note 1)

PARAMETER	SYMBOL	CONDITIONS		MIN	TYP	MAX	UNITS
Supply Voltage Range	V_{CC}	Inferred from the PSRR tests	$T_A = +25^\circ\text{C}$	1.0		5.5	V
			$T_A = -40^\circ\text{C}$ to $+85^\circ\text{C}$	1.2		5.5	
Quiescent Supply Current	I_{CC}	$V_{CC} = 1.0V$, $T_A = +25^\circ\text{C}$			9	14	μA
		$V_{CC} = 3.0V$			12	25	
		$V_{CC} = 5.5V$			18	40	
Input Offset Voltage	V_{OS}	$T_A = +25^\circ\text{C}$			± 0.2	± 2.0	mV
		$T_A = T_{MIN}$ to T_{MAX}				± 6.0	
Input Bias Current	I_B				± 5	± 15	nA
Input Offset Current	I_{OS}				± 0.5	± 2.0	nA
Differential Input Resistance	R_{IN}				50		$M\Omega$
Input Common-Mode Voltage Range	V_{CM}	Inferred from CMRR test	$V_{CC} = 1.2V$	0		$V_{CC} - 0.2$	V
			$V_{CC} = 3.0V$	0		$V_{CC} - 0.8$	
Common-Mode Rejection Ratio	CMRR	$V_{CC} = 1.2V$, $0 \leq V_{CM} \leq V_{CC} - 0.2V$			57		dB
		$V_{CC} = 1.2V$, $0 \leq V_{CM} \leq V_{CC} - 0.8V$		57	85		
		$V_{CC} = 3.0V$, $0 \leq V_{CM} \leq V_{CC} - 0.8V$		57	110		
Power-Supply Rejection Ratio	PSRR	$1.0V \leq V_{CC} \leq 5.5V$, $T_A = +25^\circ\text{C}$		54	75		dB
		$1.2V \leq V_{CC} \leq 5.5V$, $T_A = -40^\circ\text{C}$ to $+85^\circ\text{C}$		58	75		
Large-Signal Voltage Gain	A_{VOL}	$R_L = 100k\Omega$ ($50mV \leq V_{OUT} \leq V_{CC} - 50mV$)			110		dB
		$R_L = 5k\Omega$ ($100mV \leq V_{OUT} \leq V_{CC} - 100mV$)		80	90		
Output Voltage Swing High	V_{OH}	Specified as $ V_{CC} - V_{OH} $	$R_L = 100k\Omega$		0.2	10	mV
			$R_L = 5k\Omega$		7	40	
Output Voltage Swing Low	V_{OL}	Specified as V_{OL}	$R_L = 100k\Omega$		0.4	10	mV
			$R_L = 5k\Omega$		7	40	

1.0V Micropower, SOT23, Operational Amplifier

ELECTRICAL CHARACTERISTICS (continued)

($V_{CC} = 3V$, $V_{CM} = 0$, $V_{OUT} = V_{CC}/2$, R_L tied to $V_{CC}/2$, $T_A = T_{MIN}$ to T_{MAX} , unless otherwise noted. Typical values are at $T_A = +25^\circ C$.) (Note 1)

PARAMETER	SYMBOL	CONDITIONS	MIN	TYP	MAX	UNITS
Output Short-Circuit Current	I_{OUT}	Sourcing/sinking current	$V_{CC} = 1.0V$	0.6		mA
			$V_{CC} = 3.0V$	19		
Power-Up Time	t_{PU}			300		μs
Input Capacitance	C_{IN}			3.0		pF
Gain-Bandwidth Product	GBW			17		kHz
Phase Margin	θ_M			80		degrees
Gain Margin	GM			10		dB
Slew Rate	SR			6		V/ms
Capacitive-Load Stability		$A_{VCL} = +1V/V$, no sustained oscillations		200		pF
Settling Time to 0.1%	t_s	$A_{VCL} = +1V/V$, no sustained oscillations		75		μs

Note 1: All specifications are 100% production tested at $T_A = +25^\circ C$. Temperature specification limits are guaranteed by design.

Typical Operating Characteristics

($V_{CC} = 3V$, $V_{CM} = 0$, R_L to $V_{CC}/2$, $T_A = +25^\circ C$, unless otherwise noted.)

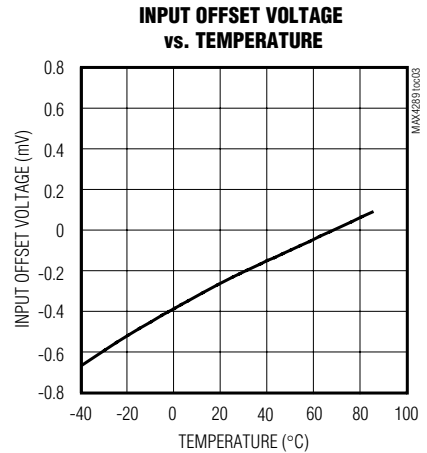
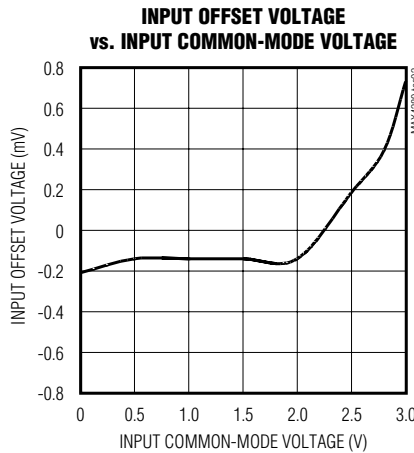
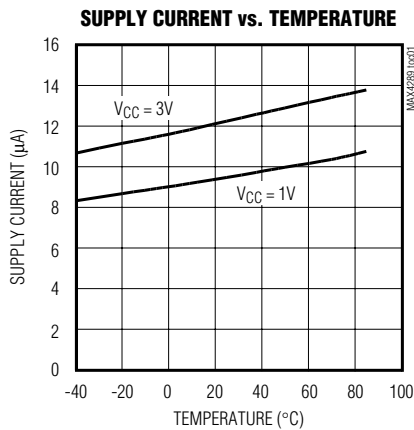

1.0V Micropower, SOT23, Operational Amplifier

Typical Operating Characteristics (continued)

($V_{CC} = 3V$, $V_{CM} = 0$, R_L to $V_{CC}/2$, $T_A = +25^\circ C$, unless otherwise noted.)

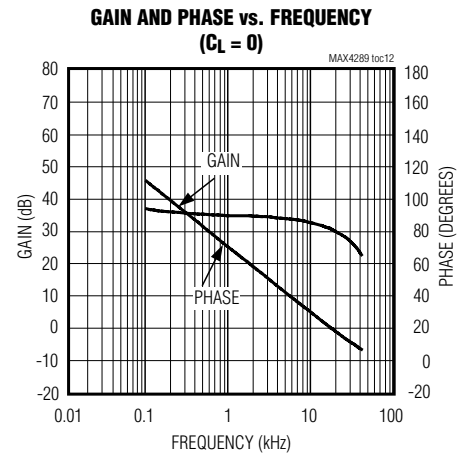
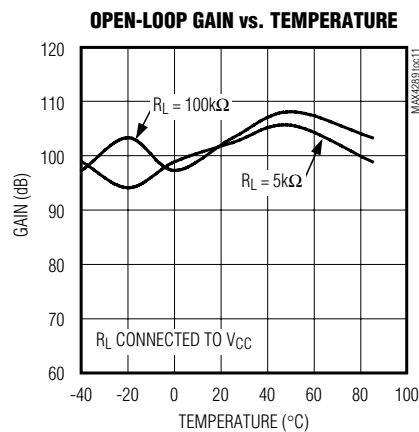
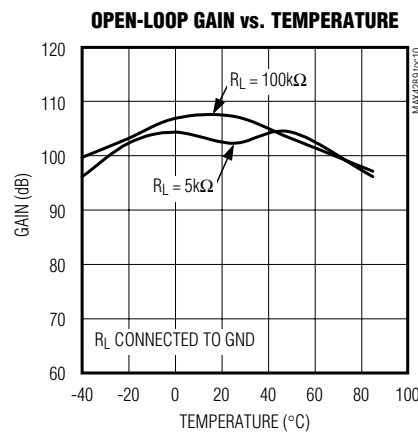
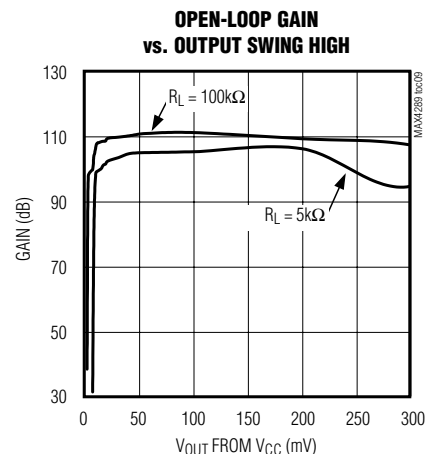
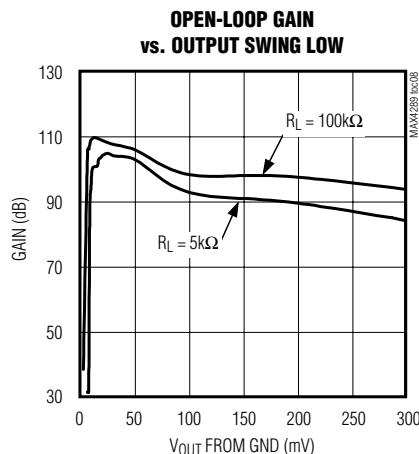
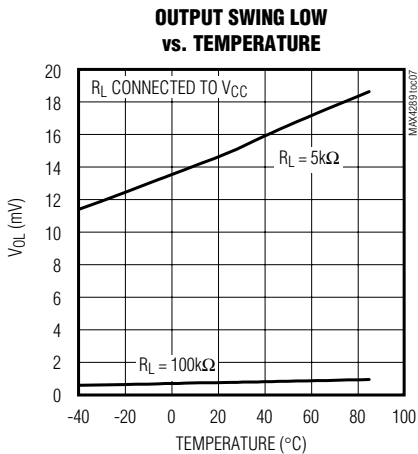
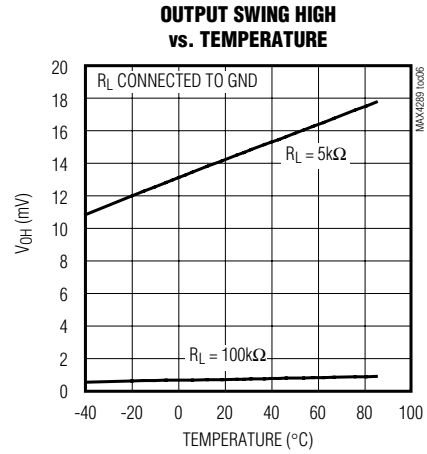
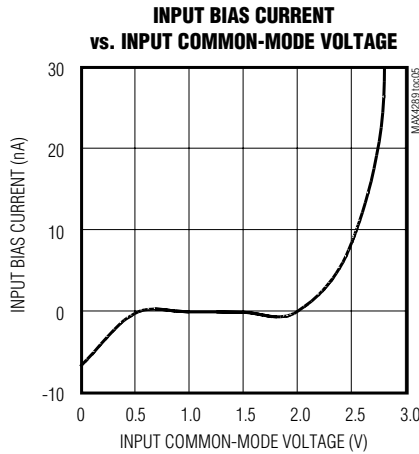
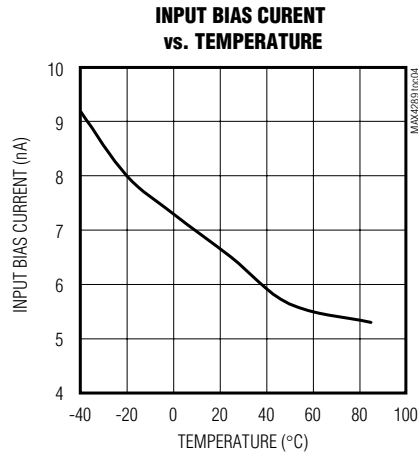

1.0V Micropower, SOT23, Operational Amplifier

Typical Operating Characteristics (continued)

($V_{CC} = 3V$, $V_{CM} = 0$, R_L to $V_{CC}/2$, $T_A = +25^\circ C$, unless otherwise noted.)

SMALL-SIGNAL TRANSIENT RESPONSE

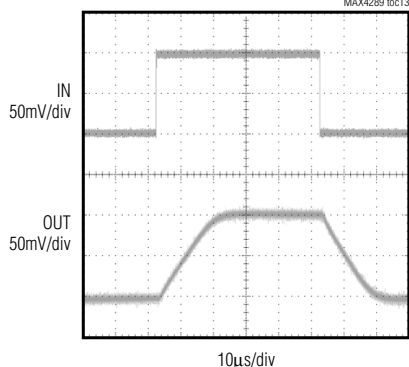

LARGE-SIGNAL TRANSIENT RESPONSE

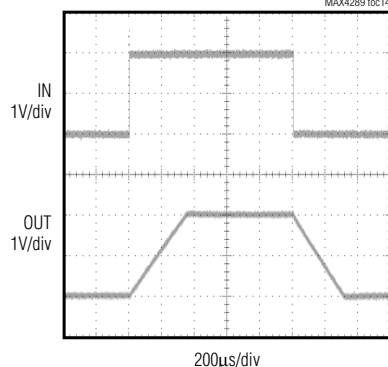

MINIMUM-OPERATING VOLTAGE vs. TEMPERATURE

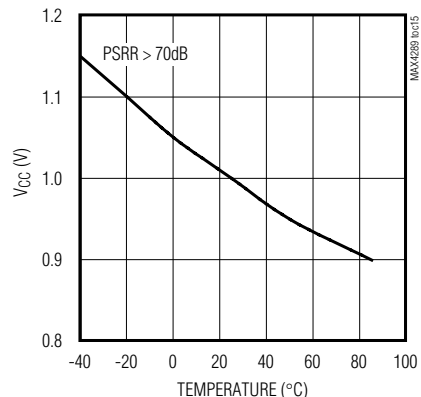

OUTPUT SINKING CURRENT vs. OUTPUT VOLTAGE

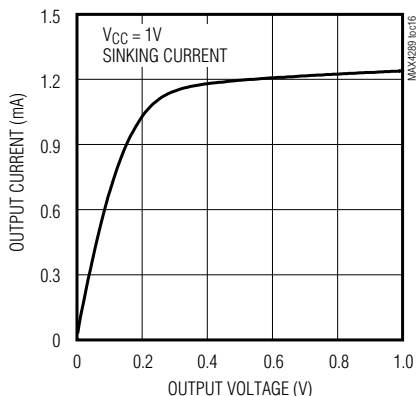

OUTPUT SINKING CURRENT vs. OUTPUT VOLTAGE

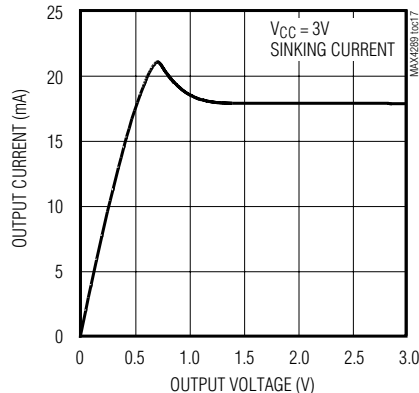

OUTPUT SOURCING CURRENT vs. OUTPUT VOLTAGE

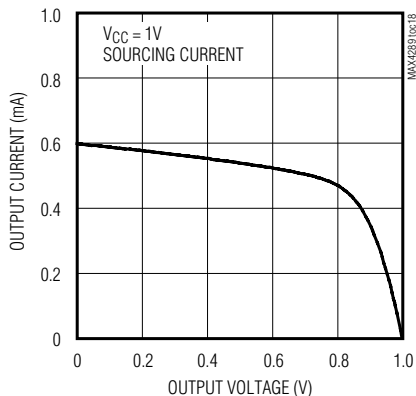

OUTPUT SOURCING CURRENT vs. OUTPUT VOLTAGE

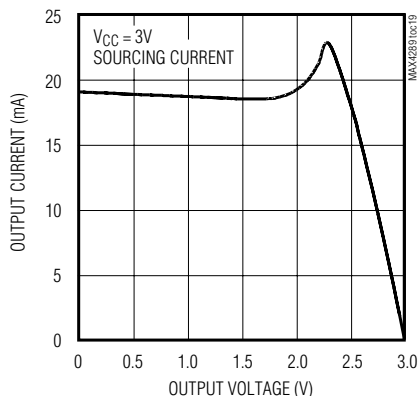

1.0V Micropower, SOT23, Operational Amplifier

Pin Description

PIN		NAME	FUNCTION
SO	SOT23		
1, 5, 8	5	N.C.	No Connection. Not internally connected.
2	4	IN-	Inverting Input
3	3	IN+	Noninverting Input
4	2	GND	Ground
6	1	OUT	Amplifier Output
7	6	V _{CC}	Positive Supply. Bypass with a 0.1μF capacitor to GND.

Detailed Description

The MAX4289 consumes ultra-low power (9μA supply current typically) and has a rail-to-rail output stage that is specifically designed for low-voltage operation. The input common-mode voltage range extends from V_{CC} - 0.2V to ground, although full rail-to-rail input range is possible with degraded performance. The input offset voltage is typically 200μV. Low-operating supply voltage, low supply current, and rail-to-rail outputs make this operational amplifier an excellent choice for precision or general-purpose, low-voltage, battery-powered systems.

Rail-to-Rail Output Stage

The MAX4289 output stage can drive a 5kΩ load and still swing to within 7mV of the rails. Figure 1 shows the output voltage swing of the MAX4289 configured as a unity-gain buffer, powered from a single 2V supply voltage. The output for this setup typically swings from +0.4mV to (V_{CC} - 0.2mV) with a 100kΩ load.

Applications Information

Power-Supply Considerations

The MAX4289 operates from a single 1.0V to 5.5V supply and consumes only 9μA of supply current. A high power-supply rejection ratio of 75dB allows the amplifier to be powered directly off a decaying battery voltage, simplifying design and extending battery life. The MAX4289 is ideally suited for single-cell battery-powered systems. Figures 2 and 3 show the supply current and PSRR as a function of supply voltage and temperature.

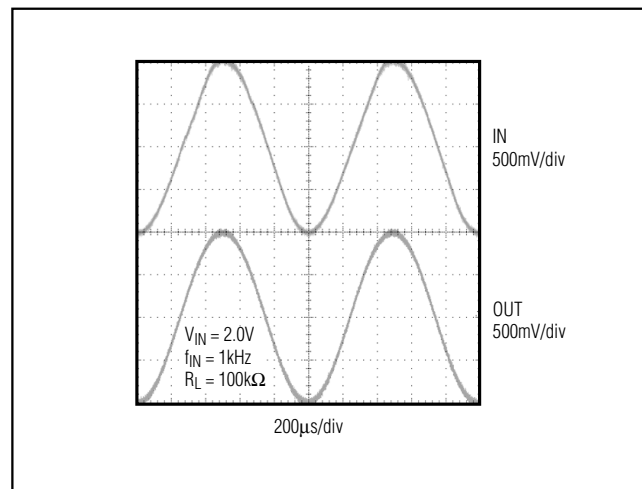

Figure 1. Rail-to-Rail Input/Output Voltage Range

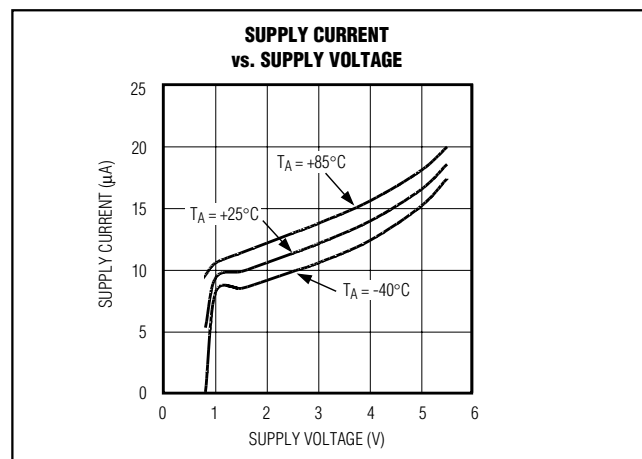

Figure 2. I_{CC} vs. V_{CC} Over the Temperature Range

1.0V Micropower, SOT23, Operational Amplifier

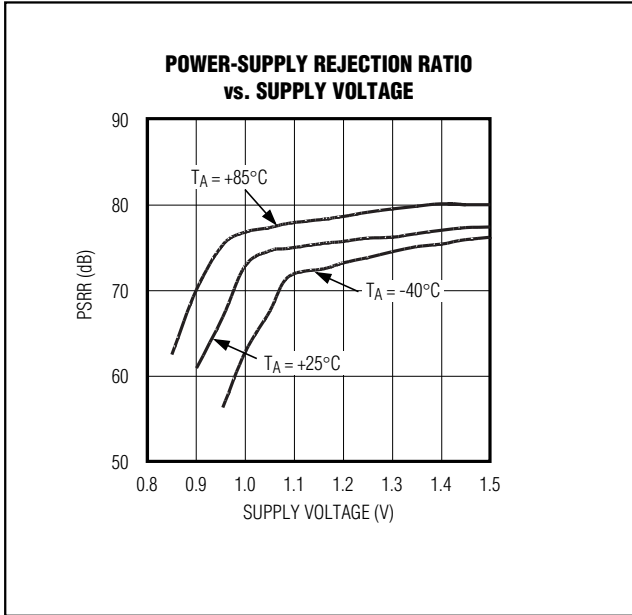

Figure 3. PSRR vs. V_{CC} Over the Temperature Range

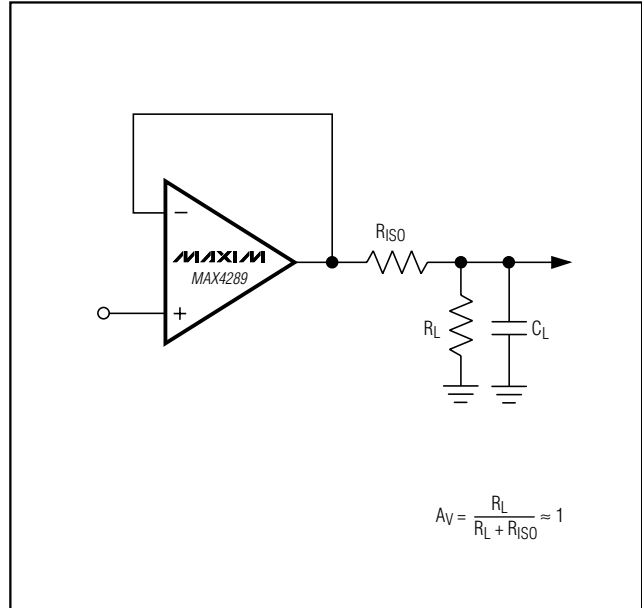

Figure 4. Using a Resistor to Isolate a Capacitive Load from the Op Amp

Power-Up Settling Time

The MAX4289 typically requires 300 μ s to power-up after V_{CC} is stable. During this startup time, the output is indeterminate. The application circuit should allow for this initial delay.

Driving Capacitive Loads

The MAX4289 is unity-gain stable for loads up to 200pF. Applications that require greater capacitive-drive capability should use an isolation resistor between the output and the capacitive load (Figure 4). Note that this solution results in a loss of gain accuracy because R_{ISO} forms a voltage-divider with the load resistor.

Using the MAX4289 as a Comparator

Although optimized for use as an operational amplifier, the MAX4289 can also be used as a rail-to-rail I/O comparator (Figure 5). External hysteresis can be used to minimize the risk of output oscillation. The positive feedback circuit, shown in Figure 5, causes the input threshold to change when the output voltage changes state.

Power Supplies and Layout

The MAX4289 operates from a single 1V to 5.5V power supply. Bypass the power with a 0.1 μ F capacitor to ground.

Good layout techniques optimize performance by decreasing the amount of stray capacitance at the op amp's inputs and outputs. To decrease stray capacitance, minimize trace lengths by placing external components close to the op amp's pins.

1.0V Micropower, SOT23, Operational Amplifier

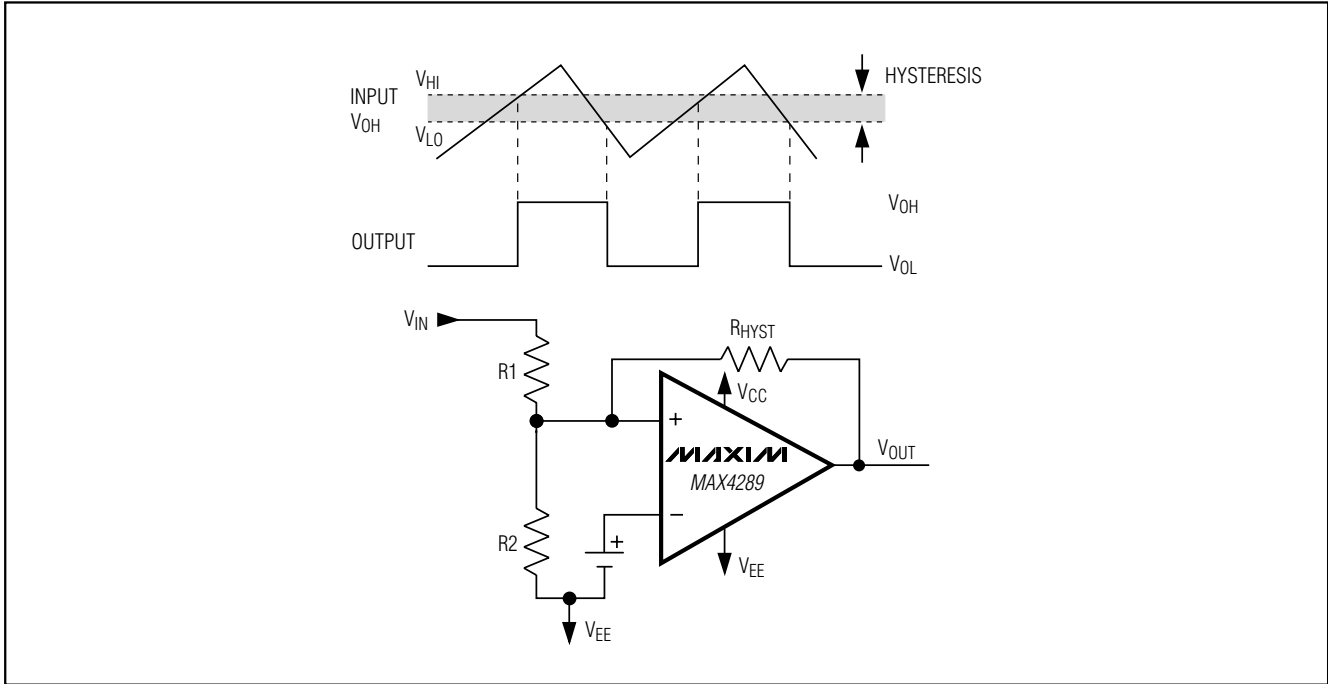

Figure 5. Hysteresis Comparator Circuit

Chip Information
TRANSISTOR COUNT: 557

1.0V Micropower, SOT23, Operational Amplifier

Package Information

MAX4289

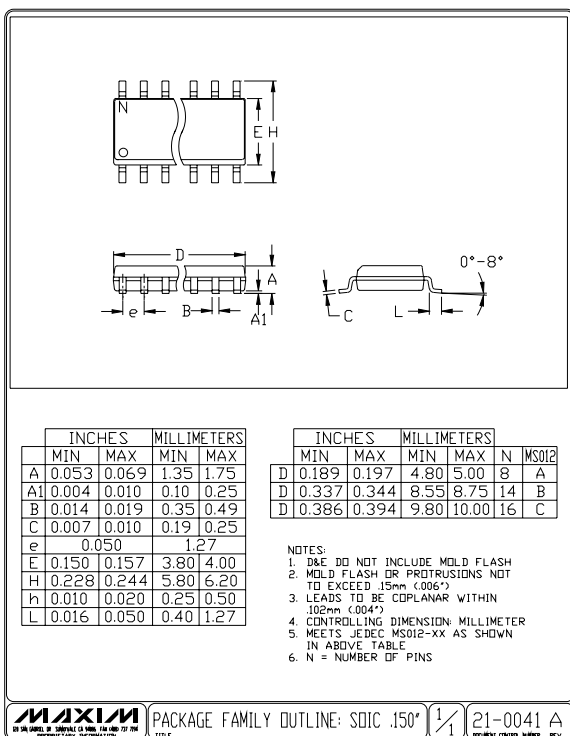
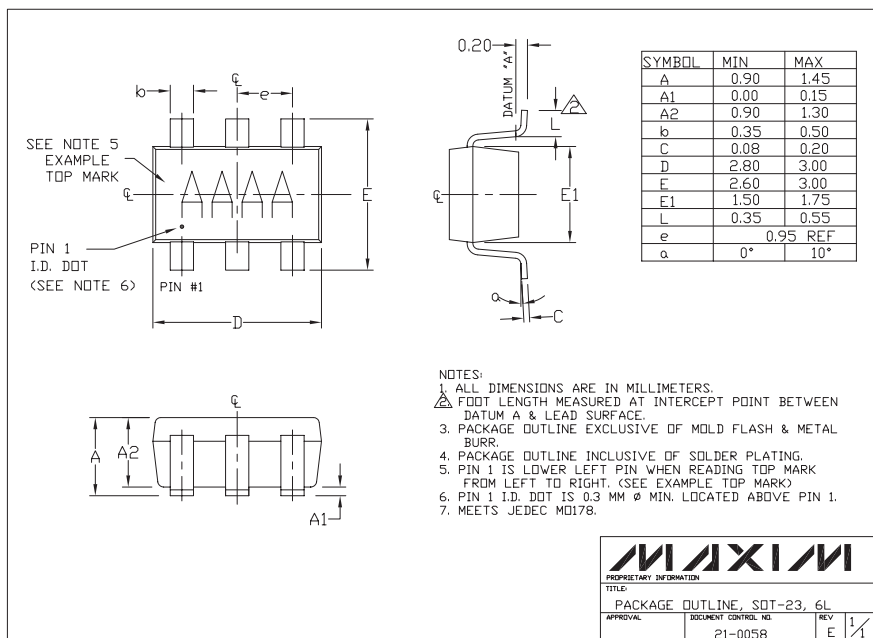

Maxim cannot assume responsibility for use of any circuitry other than circuitry entirely embodied in a Maxim product. No circuit patent licenses are implied. Maxim reserves the right to change the circuitry and specifications without notice at any time.

Maxim Integrated Products, 120 San Gabriel Drive, Sunnyvale, CA 94086 408-737-7600 _____ 9