

MAXIM

MAX4411 Evaluation Kit

General Description

The MAX4411 evaluation kit (EV kit) is a fully assembled and tested surface-mount circuit board that evaluates the MAX4411 fixed gain, DirectDrive™ stereo headphone amplifier. The DirectDrive architecture of the MAX4411 eliminates the two large DC-blocking capacitors typically required between the output of the amplifier and the headphones. Additionally, the gain of the amplifier is set internally, (-1.5V/V, MAX4411 and -2V/V, MAX4411B) further reducing component count.

Features

- ◆ No Bulky DC-Blocking Capacitors Required
- ◆ Fixed Gain Eliminates External Feedback Network
 - MAX4411: -1.5V/V
 - MAX4411B: -2V/V
- ◆ 1.8V to 3.6V Single-Supply Operation
- ◆ 80mW Per Channel into 16Ω
- ◆ Low 0.003% THD+N at 1kHz
- ◆ Independent Left/Right, Low-Power Shutdown Controls
- ◆ Ultra-Compact Solution
- ◆ Fully Assembled and Tested Surface-Mount Board

Ordering Information

PART	TEMP RANGE	IC PACKAGE
MAX4411EVKIT	0°C to +70°C	20 Thin QFN

Component Suppliers

SUPPLIER	PHONE	FAX	WEBSITE
AVX	843-946-0238	843-626-3123	www.avxcorp.com
Taiyo Yuden	800-348-2496	847-925-0899	www.t-yuden.com
TDK	847-803-6100	847-390-4405	www.component.tdk.com

Note: Indicate that you are using the MAX4411 when contacting these component suppliers.

Component List

DESIGNATION	QTY	DESCRIPTION
C1, C2, C3	3	2.2μF ±10%, 6.3V X5R ceramic capacitors (0603) TDK C1608X5R0J225K Taiyo Yuden JMK107BJ225KA
C4	1	10μF ±20%, 6.3V X5R ceramic capacitor (0805) TDK C2012X5R0J106M Taiyo Yuden JMK212BJ106MG
C5	1	0.1μF ±10%, 16V X7R ceramic capacitor (0603) TDK C1608X7R1C104K Taiyo Yuden EMK107BJ104KA

DESIGNATION	QTY	DESCRIPTION
C6, C7	2	1.0μF ±10%, 16V tantalum capacitors (A-case) AVX TAJA105K016R
J1	1	Stereo headphone jack (3.5mm dia.)
JU1, JU2	2	3-pin headers
None	2	Shunts
R1, R2	2	10kΩ ±1% resistors (0603)
U1	1	MAX4411ETP (20-pin TQFN, 4mm x 4mm x 0.8mm)
None	1	MAX4411 EV kit PC board
None	1	MAX4411 EV kit data sheet
None	1	MAX4411 data sheet

MAX4411 Evaluation Kit

Quick Start

Recommended Equipment

- One pair of 16 Ω or 32 Ω headphones
- One variable DC power supply capable of supplying between 1.8V and 3.6V at 300mA
- One stereo audio source

Procedure

The MAX4411 EV kit is fully assembled and tested. Follow the steps below to verify board operation. Do not turn on the power supply until all connections are completed:

- 1) Verify that shunts are installed across pins 1 and 2 of jumpers JU1 and JU2.
- 1) Plug the headphones into the 3.5mm headphone jack.
- 3) Ensure that the stereo audio source is turned off.
- 4) Connect the disabled audio source between IN₋ and GND.
- 5) Connect the 1.8V to 3.6V DC power supply to the VDD and GND pads.
- 6) Turn on the DC power supply.
- 7) Enable the stereo audio source.

Detailed Description

The MAX4411 is a fixed-gain, stereo headphone amplifier featuring Maxim's patented DirectDrive architecture. The device consists of two 80mW Class AB headphone amplifiers, an internal feedback network, under-voltage lockout (UVLO)/shutdown control, a charge pump, and comprehensive click-and-pop suppression circuitry.

The MAX4411 EV kit has an internal gain of -1.5V/V and can be powered with a 1.8V to 3.6V single supply. The MAX4411 EV kit can be used to evaluate the MAX4411B. The MAX4411B has an internal -2V/V gain. To evaluate the MAX4411B, request a MAX4411BETP free sample with the MAX4411 EV kit.

Shutdown Control

The MAX4411 EV kit provides two shutdown pins ($\overline{\text{SHDNL}}$ and $\overline{\text{SHDNR}}$) to disable the outputs, allowing each channel to be shut down independently. Jumpers JU1 and JU2 control the left and right channels, respectively (see Table 1 for shutdown shunt positions).

Shorting pin 2 of JU1 to pin 2 of JU2 allows the user to control both channels' shutdown pins simultaneously by driving the provided user pad $\overline{\text{SHDN}}$ with an external source (see Figure 1 for shunt configuration). $\overline{\text{SHDNL}}$ and $\overline{\text{SHDNR}}$ are CMOS logic-level inputs.

Layout Considerations

To optimize the audio performance of the MAX4411, it is important to follow these layout guidelines. The MAX4411 EV kit uses two ground planes to minimize switching noise from the charge-pump coupling into the audio signal. The two planes are star-connected at one point (GND pad). Capacitors C1, C2, and C3 should be placed close to the IC. Short, wide traces should be used to connect the power pins of the IC to the power supply.

Note: Capacitors C1 and C2 can be reduced in size. See Figure 3 and the MAX4411 data sheet for details.

Table 1. Shutdown Selection

JUMPER	SHUNT POSITION	DESCRIPTION
JU1	1-2	Left channel enabled
	2-3	Left channel disabled
JU2	1-2	Right channel enabled
	2-3	Right channel disabled

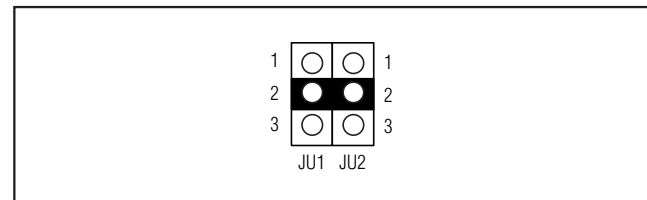

Figure 1. Simultaneous Shutdown Control

MAX4411 Evaluation Kit

Evaluates: MAX4411

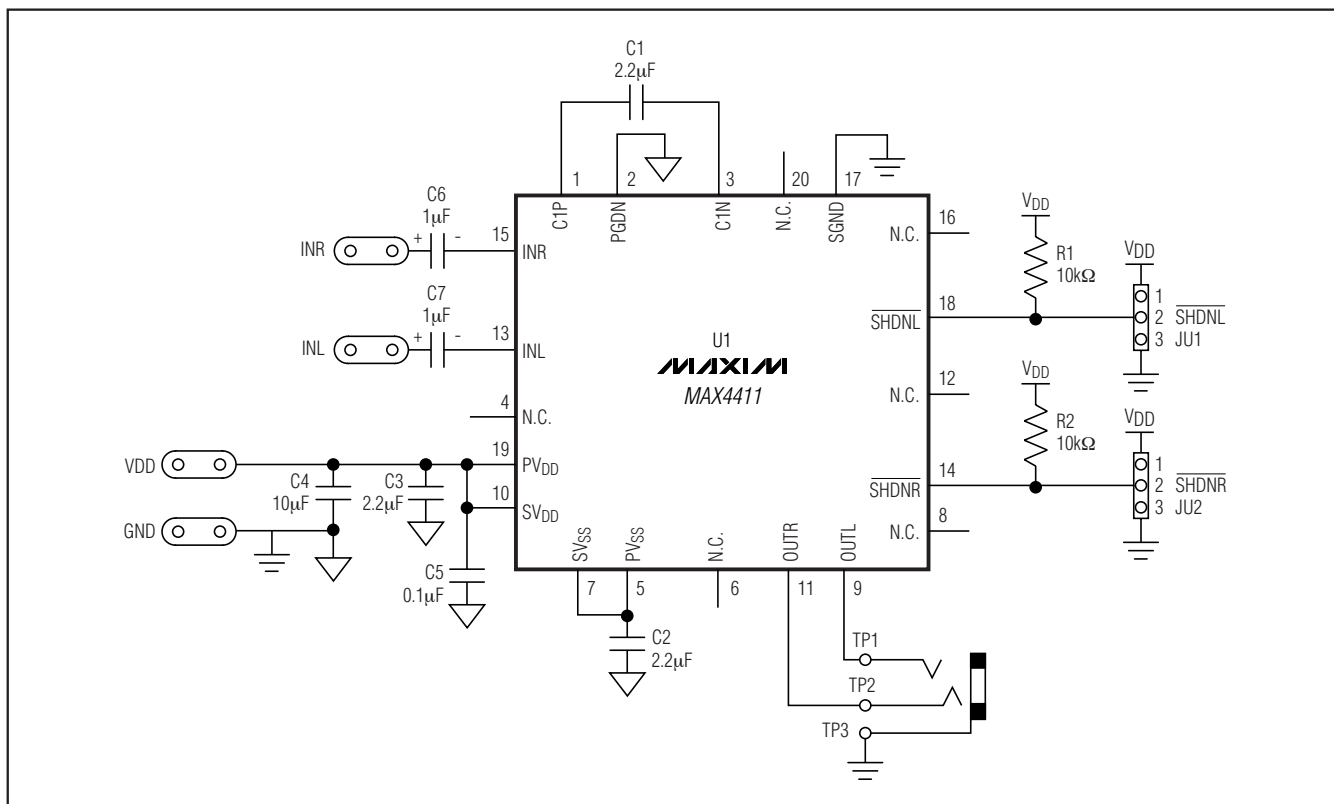

Figure 2. MAX4411 EV Kit Schematic

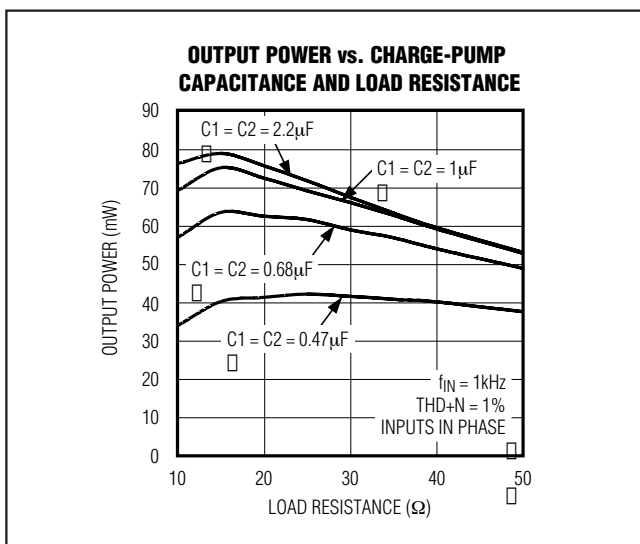

Figure 3. Output Power vs. C1 and C2

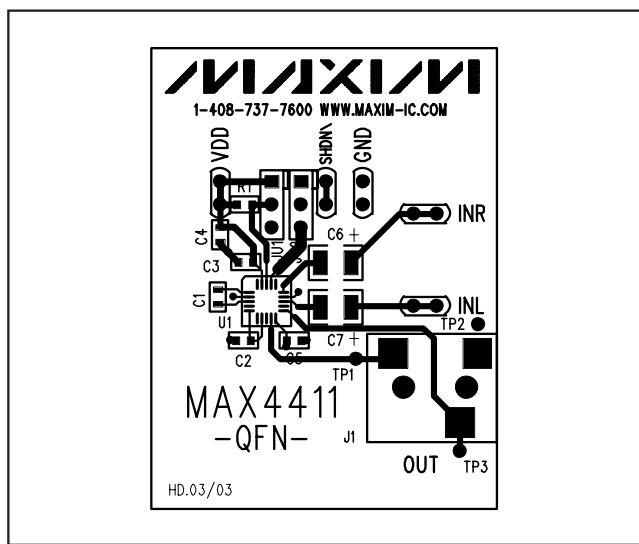

Figure 4. MAX4411 EV Kit Component Placement Guide—Component Side

MAX4410 Evaluation Kit

Evaluates: MAX4411

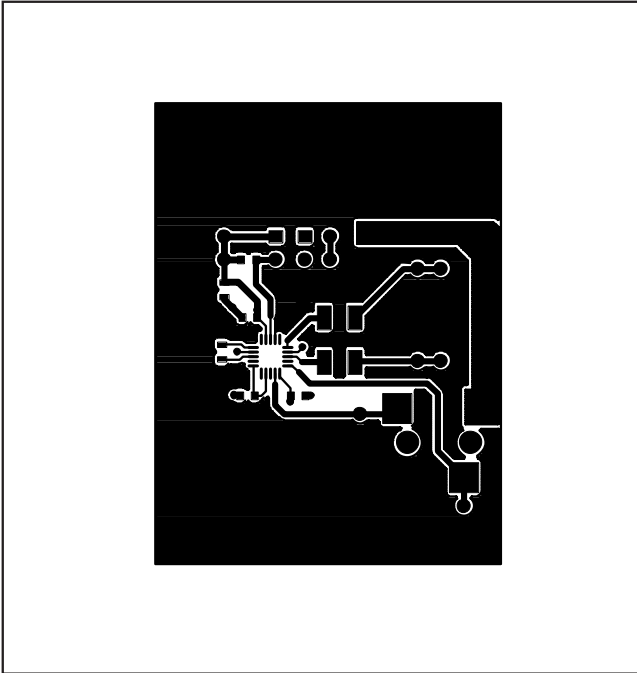

Figure 5. MAX4411 EV Kit PC Board Layout—Component Side

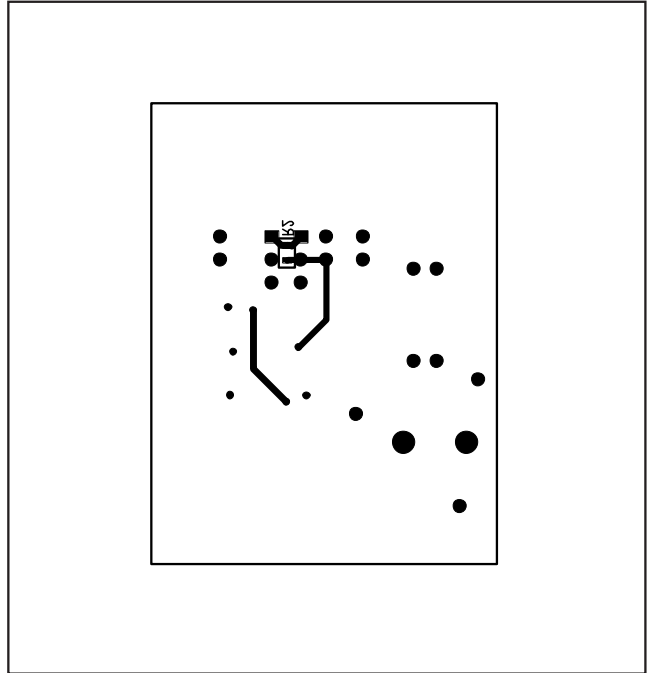

Figure 6. MAX4411 EV Kit Component Placement Guide—Solder Side

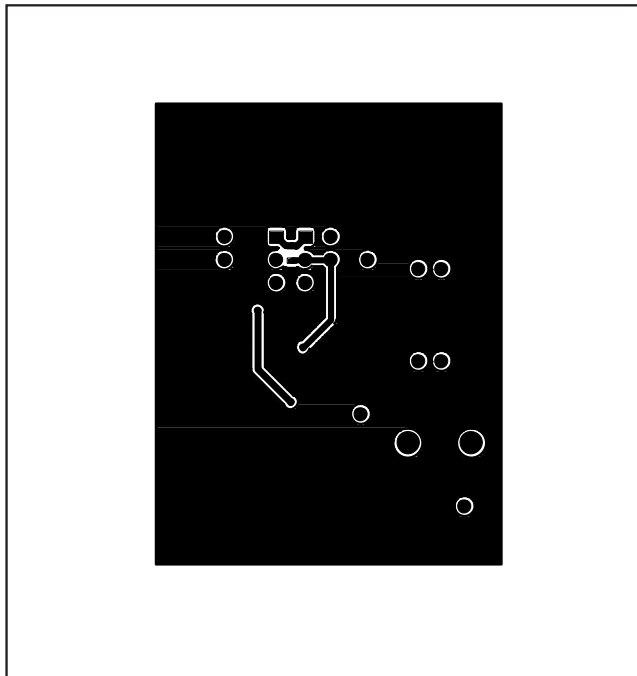

Figure 7. MAX4411 EV Kit PC Board Layout—Solder Side

Maxim cannot assume responsibility for use of any circuitry other than circuitry entirely embodied in a Maxim product. No circuit patent licenses are implied. Maxim reserves the right to change the circuitry and specifications without notice at any time.

4 _____ **Maxim Integrated Products, 120 San Gabriel Drive, Sunnyvale, CA 94086 408-737-7600**