



Precision, Micropower, Low-Dropout Voltage References

General Description

The MAX6190–MAX6195/MAX6198 precision, micropower, low-dropout voltage references offer high initial accuracy and very low temperature coefficient through a proprietary curvature-correction circuit and laser-trimmed precision thin-film resistors.

These series-mode bandgap references draw a maximum of only 35 μ A quiescent supply current, making them ideal for battery-powered instruments. They offer a supply current that is virtually immune to input voltage variations. Load-regulation specifications are guaranteed for source and sink currents up to 500 μ A. These devices are internally compensated, making them ideal for applications that require fast settling, and are stable with capacitive loads up to 2.2nF.

Selector Guide

PART	OUTPUT VOLTAGE (V)	INITIAL ACCURACY (mV)	TEMPERATURE COEFFICIENT (ppm)
MAX6190A	1.250	± 2	<5
MAX6190B	1.250	± 4	<10
MAX6190C	1.250	± 6	<25
MAX6191A	2.048	± 2	<5
MAX6191B	2.048	± 5	<10
MAX6191C	2.048	± 10	<25
MAX6192A	2.500	± 2	<5
MAX6192B	2.500	± 5	<10
MAX6192C	2.500	± 10	<25
MAX6193A	3.000	± 2	<5
MAX6193B	3.000	± 5	<10
MAX6193C	3.000	± 10	<25
MAX6198A	4.096	± 2	<5
MAX6198B	4.096	± 5	<10
MAX6198C	4.096	± 10	<25
MAX6194A	4.500	± 2	<5
MAX6194B	4.500	± 5	<10
MAX6194C	4.500	± 10	<25
MAX6195A	5.000	± 2	<5
MAX6195B	5.000	± 5	<10
MAX6195C	5.000	± 10	<25

Typical Operating Circuit appears at end of data sheet.

Features

- ◆ ± 2 mV (max) Initial Accuracy
- ◆ 5ppm/ $^{\circ}$ C (max) Temperature Coefficient
- ◆ 35 μ A (max) Supply Current
- ◆ 100mV Dropout at 500 μ A Load Current
- ◆ 0.12 μ V/V Load Regulation
- ◆ 8 μ V/V Line Regulation

Applications

Hand-Held Instruments
Analog-to-Digital and Digital-to-Analog Converters
Industrial Process Control
Precision 3V/5V Systems
Hard-Disk Drives

Ordering Information

PART	TEMP. RANGE	PIN-PACKAGE
MAX6190AESA	-40 $^{\circ}$ C to +85 $^{\circ}$ C	8 SO
MAX6190BESA	-40 $^{\circ}$ C to +85 $^{\circ}$ C	8 SO
MAX6190CESA	-40 $^{\circ}$ C to +85 $^{\circ}$ C	8 SO
MAX6191AESA	-40 $^{\circ}$ C to +85 $^{\circ}$ C	8 SO
MAX6191BESA	-40 $^{\circ}$ C to +85 $^{\circ}$ C	8 SO
MAX6191CESA	-40 $^{\circ}$ C to +85 $^{\circ}$ C	8 SO
MAX6192AESA	-40 $^{\circ}$ C to +85 $^{\circ}$ C	8 SO
MAX6192BESA	-40 $^{\circ}$ C to +85 $^{\circ}$ C	8 SO
MAX6192CESA	-40 $^{\circ}$ C to +85 $^{\circ}$ C	8 SO

Ordering Information continued at end of data sheet.

Pin Configuration

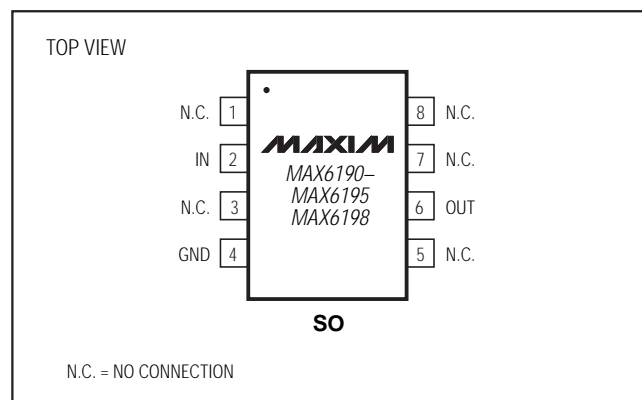

MAX6190-MAX6195/MAX6198



Precision, Micropower, Low-Dropout Voltage References

ABSOLUTE MAXIMUM RATINGS

Voltages Referenced to GND

IN-0.3V to +13.5V

OUT-0.3V to ($V_{IN} + 0.3V$)

Output Short Circuit to GND or IN ($V_{IN} < 6V$)Continuous

Output Short Circuit to GND or IN ($V_{IN} \geq 6V$)60sec

Continuous Power Dissipation ($T_A = +70^\circ C$)

8-pin SO (derate 5.88mW/ $^\circ C$ above $+70^\circ C$).....471mW

Operating Temperature Range-40 $^\circ C$ to +85 $^\circ C$

Storage Temperature Range-65 $^\circ C$ to +150 $^\circ C$

Lead Temperature (soldering, 10sec)+300 $^\circ C$

Stresses beyond those listed under "Absolute Maximum Ratings" may cause permanent damage to the device. These are stress ratings only, and functional operation of the device at these or any other conditions beyond those indicated in the operational sections of the specifications is not implied. Exposure to absolute maximum rating conditions for extended periods may affect device reliability.

ELECTRICAL CHARACTERISTICS—MAX6190

($V_{IN} = +5V$, $I_{OUT} = 0$, $T_A = T_{MIN}$ to T_{MAX} , unless otherwise noted. Typical values are at $T_A = +25^\circ C$.)

PARAMETER	SYMBOL	CONDITIONS	MIN	TYP	MAX	UNITS	
OUTPUT							
Output Voltage	V_{OUT}	$T_A = +25^\circ C$	MAX6190A	1.248	1.250	1.252	V
			MAX6190B	1.246	1.250	1.254	
			MAX6190C	1.244	1.250	1.256	
Output Voltage Temperature Coefficient (Note 1)	TCV_{OUT}	MAX6190A		2	5	ppm/ $^\circ C$	
		MAX6190B		4	10		
		MAX6190C		8	25		
Line Regulation	$\frac{\Delta V_{OUT}}{\Delta V_{IN}}$	$2.5V \leq V_{IN} \leq 12.6V$		8	80	$\mu V/V$	
Load Regulation	$\frac{\Delta V_{OUT}}{\Delta I_{OUT}}$	Sourcing: $0 \leq I_{OUT} \leq 500\mu A$		0.12	0.5	$\mu V/\mu A$	
		Sinking: $-500\mu A \leq I_{OUT} \leq 0$		0.15	0.6		
Short-Circuit Current	I_{SC}	Short to GND		4		mA	
		Short to IN		4			
Temperature Hysteresis (Note 2)	$\frac{\Delta V_{OUT}}{\text{cycle}}$			75		ppm	
Long-Term Stability	$\frac{\Delta V_{OUT}}{\text{time}}$	1000hrs at $+25^\circ C$		50		ppm/ 1000hrs	
DYNAMIC							
Noise Voltage	e_{OUT}	0.1Hz to 10Hz		25		$\mu Vp-p$	
		10Hz to 10kHz		65		μV_{RMS}	
Ripple Rejection	V_{OUT}/V_{IN}	$V_{IN} = 5V \pm 100mV$, $f = 120Hz$		86		dB	
Turn-On Settling Time	t_R	To 0.1%, $C_{OUT} = 50pF$		30		μs	
Capacitive-Load Stability Range	C_{OUT}	(Note 3)	0		2.2	nF	
INPUT							
Supply Voltage Range	V_{IN}	Guaranteed by line-regulation test	2.5		12.6	V	
Quiescent Supply Current	I_{IN}			27	35	μA	
Change in Supply Current	I_{IN}/V_{IN}	$2.5V \leq V_{IN} \leq 12.6V$		0.8	2	$\mu A/V$	

Precision, Micropower, Low-Dropout Voltage References

ELECTRICAL CHARACTERISTICS—MAX6191

($V_{IN} = +5V$, $I_{OUT} = 0$, $T_A = T_{MIN}$ to T_{MAX} , unless otherwise noted. Typical values are at $T_A = +25^\circ C$.)

PARAMETER	SYMBOL	CONDITIONS	MIN	TYP	MAX	UNITS	
OUTPUT							
Output Voltage	V_{OUT}	$T_A = +25^\circ C$	MAX6191A	2.046	2.048	2.050	V
			MAX6191B	2.043	2.048	2.053	
			MAX6191C	2.038	2.048	2.058	
Output Voltage Temperature Coefficient (Note 1)	TCV_{OUT}	MAX6191A		2	5	ppm/ $^\circ C$	
		MAX6191B		4	10		
		MAX6191C		8	25		
Line Regulation	$\frac{\Delta V_{OUT}}{\Delta V_{IN}}$	$2.5V \leq V_{IN} \leq 12.6V$		10	100	$\mu V/V$	
Load Regulation	$\frac{\Delta V_{OUT}}{\Delta I_{OUT}}$	Sourcing: $0 \leq I_{OUT} \leq 500\mu A$		0.12	0.55	$\mu V/\mu A$	
		Sinking: $-500\mu A \leq I_{OUT} \leq 0$		0.18	0.70		
Short-Circuit Current	I_{SC}	Short to GND		4		mA	
		Short to IN		4			
Temperature Hysteresis (Note 2)	$\frac{\Delta V_{OUT}}{\text{cycle}}$			75		ppm	
Long-Term Stability	$\frac{\Delta V_{OUT}}{\text{time}}$	1000hrs at $+25^\circ C$		50		ppm/1000hrs	
DYNAMIC							
Noise Voltage	e_{OUT}	0.1Hz to 10Hz		40		$\mu Vp-p$	
		10Hz to 10kHz		105		μV_{RMS}	
Ripple Rejection	V_{OUT}/V_{IN}	$V_{IN} = 5V \pm 100mV$, $f = 120Hz$		84		dB	
Turn-On Settling Time	t_R	To 0.1%, $C_{OUT} = 50pF$		30		μs	
Capacitive-Load Stability Range	C_{OUT}	(Note 3)	0		2.2	nF	
INPUT							
Supply Voltage Range	V_{IN}	Guaranteed by line-regulation test	2.5		12.6	V	
Quiescent Supply Current	I_{IN}			27	35	μA	
Change in Supply Current	I_{IN}/V_{IN}	$2.5V \leq V_{IN} \leq 12.6V$		0.8	2	$\mu A/V$	

MAX6190-MAX6195/MAX6198

Precision, Micropower, Low-Dropout Voltage References

MAX6190-MAX6195/MAX6198

ELECTRICAL CHARACTERISTICS—MAX6192

($V_{IN} = +5V$, $I_{OUT} = 0$, $T_A = T_{MIN}$ to T_{MAX} , unless otherwise noted. Typical values are at $T_A = +25^\circ C$.)

PARAMETER	SYMBOL	CONDITIONS	MIN	TYP	MAX	UNITS	
OUTPUT							
Output Voltage	V_{OUT}	$T_A = +25^\circ C$	MAX6192A	2.498	2.500	2.502	V
			MAX6192B	2.495	2.500	2.505	
			MAX6192C	2.490	2.500	2.510	
Output Voltage Temperature Coefficient (Note 1)	TCV_{OUT}	MAX6192A		2	5	ppm/ $^\circ C$	
		MAX6192B		4	10		
		MAX6192C		8	25		
Line Regulation	$\frac{\Delta V_{OUT}}{\Delta V_{IN}}$	$(V_{OUT} + 0.2V) \leq V_{IN} \leq 12.6V$		15	140	$\mu V/V$	
Load Regulation	$\frac{\Delta V_{OUT}}{\Delta I_{OUT}}$	Sourcing: $0 \leq I_{OUT} \leq 500\mu A$		0.14	0.60	$\mu V/\mu A$	
		Sinking: $-500\mu A \leq I_{OUT} \leq 0$		0.18	0.80		
Dropout Voltage (Note 4)	$V_{IN} - V_{OUT}$	$\Delta V_{OUT} \leq 0.2\%$, $I_{OUT} = 500\mu A$		100	200	mV	
Short-Circuit Current	I_{SC}	Short to GND		4		mA	
		Short to IN		4			
Temperature Hysteresis (Note 2)	$\frac{\Delta V_{OUT}}{\text{cycle}}$			75		ppm	
Long-Term Stability	$\frac{\Delta V_{OUT}}{\text{time}}$	1000hrs at $+25^\circ C$		50		ppm/ 1000hrs	
DYNAMIC							
Noise Voltage	e_{OUT}	0.1Hz to 10Hz		60		μV_{p-p}	
		10Hz to 10kHz		125		μV_{RMS}	
Ripple Rejection	V_{OUT}/V_{IN}	$V_{IN} = 5V \pm 100mV$, $f = 120Hz$		82		dB	
Turn-On Settling Time	t_R	To 0.1%, $C_{OUT} = 50pF$		85		μs	
Capacitive-Load Stability Range	C_{OUT}	(Note 3)	0		2.2	nF	
INPUT							
Supply Voltage Range	V_{IN}	Guaranteed by line-regulation test	$V_{OUT} + 0.2$		12.6	V	
Quiescent Supply Current	I_{IN}			27	35	μA	
Change in Supply Current	I_{IN}/V_{IN}	$(V_{OUT} + 0.2V) \leq V_{IN} \leq 12.6V$		0.8	2	$\mu A/V$	

Precision, Micropower, Low-Dropout Voltage References

ELECTRICAL CHARACTERISTICS—MAX6193

($V_{IN} = +5V$, $I_{OUT} = 0$, $T_A = T_{MIN}$ to T_{MAX} , unless otherwise noted. Typical values are at $T_A = +25^\circ C$.)

PARAMETER	SYMBOL	CONDITIONS	MIN	TYP	MAX	UNITS	
OUTPUT							
Output Voltage	V_{OUT}	$T_A = +25^\circ C$	MAX6193A	2.998	3.000	3.002	V
			MAX6193B	2.995	3.000	3.005	
			MAX6193C	2.990	3.000	3.010	
Output Voltage Temperature Coefficient (Note 1)	TCV_{OUT}	MAX6193A		2	5	ppm/ $^\circ C$	
		MAX6193B		4	10		
		MAX6193C		8	25		
Line Regulation	$\frac{\Delta V_{OUT}}{\Delta V_{IN}}$	$2.5V \leq V_{IN} \leq 12.6V$		20	150	$\mu V/V$	
Load Regulation	$\frac{\Delta V_{OUT}}{\Delta I_{OUT}}$	$2.5V \leq V_{IN} \leq 12.6V$		0.14	0.60	$\mu V/V$	
				0.18	0.80		
Dropout Voltage (Note 4)	$V_{IN} - V_{OUT}$	$I_{OUT} = 500\mu A$		100	200	mV	
Short-Circuit Current	I_{SC}	Short to GND		4		mA	
		Short to IN		4			
Temperature Hysteresis (Note 2)	$\frac{\Delta V_{OUT}}{\text{cycle}}$			75		ppm	
Long-Term Stability	$\frac{\Delta V_{OUT}}{\text{time}}$	1000hrs at $+25^\circ C$		50		ppm/1000hrs	
DYNAMIC							
Noise Voltage	e_{OUT}	0.1Hz to 10Hz		75		μV_{p-p}	
		10Hz to 10kHz		150		μV_{RMS}	
Ripple Rejection	V_{OUT}/V_{IN}	$V_{IN} = 5V \pm 100mV$, $f = 120Hz$		80		dB	
Turn-On Settling Time	t_R	To 0.1%, $C_{OUT} = 50pF$		100		μs	
Capacitive-Load Stability Range	C_{OUT}	(Note 3)	0		2.2	nF	
INPUT							
Supply Voltage Range	V_{IN}	Guaranteed by line-regulation test	$V_{OUT} + 0.2$		12.6	V	
Quiescent Supply Current	I_{IN}			27	35	μA	
Change in Supply Current	I_{IN}/V_{IN}	$(V_{OUT} + 0.2V) \leq V_{IN} \leq 12.6V$		0.8	2	$\mu A/V$	

MAX6190-MAX6195/MAX6198

Precision, Micropower, Low-Dropout Voltage References

MAX6190-MAX6195/MAX6198

ELECTRICAL CHARACTERISTICS—MAX6194

($V_{IN} = +5V$, $I_{OUT} = 0$, $T_A = T_{MIN}$ to T_{MAX} , unless otherwise noted. Typical values are at $T_A = +25^\circ C$.)

PARAMETER	SYMBOL	CONDITIONS	MIN	TYP	MAX	UNITS	
INPUT							
Output Voltage	V_{OUT}	$T_A = +25^\circ C$	MAX6194A	4.498	4.500	4.502	V
			MAX6194B	4.495	4.500	4.505	
			MAX6194C	4.490	4.500	4.510	
Output Voltage Temperature Coefficient (Note 1)	TCV_{OUT}	MAX6194A		2	5	ppm/ $^\circ C$	
		MAX6194B		4	10		
		MAX6194C		8	25		
Line Regulation	$\frac{\Delta V_{OUT}}{\Delta V_{IN}}$	$(V_{OUT} + 0.2V) \leq V_{IN} \leq 12.6V$		25	160	$\mu V/V$	
Load Regulation	$\frac{\Delta V_{OUT}}{\Delta I_{OUT}}$	Sourcing: $0 \leq I_{OUT} \leq 500\mu A$		0.16	0.80	$\mu V/\mu A$	
		Sinking: $-500\mu A \leq I_{OUT} \leq 0$		0.22	1.00		
Dropout Voltage (Note 4)	$V_{IN} - V_{OUT}$	$\Delta V_{OUT} \leq 0.2\%$, $I_{OUT} = 500\mu A$		100	200	mV	
Short-Circuit Current	I_{SC}	Short to GND		4		mA	
		Short to IN		4			
Temperature Hysteresis (Note 2)	$\frac{\Delta V_{OUT}}{\text{cycle}}$			75		ppm	
Long-Term Stability	$\frac{\Delta V_{OUT}}{\text{time}}$	1000hrs at $+25^\circ C$		50		ppm/ 1000hrs	
DYNAMIC							
Noise Voltage	e_{OUT}	0.1Hz to 10Hz		110		μV_{p-p}	
		10Hz to 10kHz		215		μV_{RMS}	
Ripple Rejection	V_{OUT}/V_{IN}	$V_{IN} = 5V \pm 100mV$, $f = 120Hz$		76		dB	
Turn-On Settling Time	t_R	To 0.1%, $C_{OUT} = 50pF$		180		μs	
Capacitive-Load Stability Range	C_{OUT}	(Note 3)	0		2.2	nF	
OUTPUT							
Supply Voltage Range	V_{IN}	Guaranteed by line-regulation test	$V_{OUT} + 0.2$		12.6	V	
Quiescent Supply Current	I_{IN}			27	35	μA	
Change in Supply Current	I_{IN}/V_{IN}	$(V_{OUT} + 0.2V) \leq V_{IN} \leq 12.6V$		0.8	2	$\mu A/V$	

Precision, Micropower, Low-Dropout Voltage References

ELECTRICAL CHARACTERISTICS—MAX6195

($V_{IN} = +5.5V$, $I_{OUT} = 0$, $T_A = T_{MIN}$ to T_{MAX} , unless otherwise noted. Typical values are at $T_A = +25^\circ C$.)

PARAMETER	SYMBOL	CONDITIONS	MIN	TYP	MAX	UNITS	
INPUT							
Output Voltage	V_{OUT}	$T_A = +25^\circ C$	MAX6195A	4.998	5.000	5.002	V
			MAX6195B	4.995	5.000	5.005	
			MAX6195C	4.990	5.000	5.010	
Output Voltage Temperature Coefficient (Note 1)	TCV_{OUT}	MAX6195A		2	5	ppm/ $^\circ C$	
		MAX6195B		4	10		
		MAX6195C		8	25		
Line Regulation	$\frac{\Delta V_{OUT}}{\Delta V_{IN}}$	$(V_{OUT} + 0.2V) \leq V_{IN} \leq 12.6V$		25	160	$\mu V/V$	
Load Regulation	$\frac{\Delta V_{OUT}}{\Delta I_{OUT}}$	Sourcing: $0 \leq I_{OUT} \leq 500\mu A$		0.17	0.85	$\mu V/\mu A$	
		Sinking: $-500\mu A \leq I_{OUT} \leq 0$		0.24	1.10		
Dropout Voltage (Note 4)	$V_{IN} - V_{OUT}$	$\Delta V_{OUT} \leq 0.2\%$, $I_{OUT} = 500\mu A$		100	200	mA	
Short-Circuit Current	I_{SC}	Short to GND		4		mA	
		Short to IN		4			
Temperature Hysteresis (Note 2)	$\Delta V_{OUT}/$ cycle			75		ppm	
Long-Term Stability	$\Delta V_{OUT}/$ time	1000hrs at $+25^\circ C$		50		ppm/ 1000hrs	
DYNAMIC							
Noise Voltage	e_{OUT}	0.1Hz to 10Hz		120		$\mu Vp-p$	
		10Hz to 10kHz		240		μV_{RMS}	
Ripple Rejection	V_{OUT}/V_{IN}	$V_{IN} = 5.5V \pm 100mV$, $f = 120Hz$		72		dB	
Turn-On Settling Time	t_R	To 0.1%, $C_{OUT} = 50pF$		220		μs	
Capacitive-Load Stability Range	C_{OUT}	(Note 3)	0		2.2	nF	
OUTPUT							
Supply Voltage Range	V_{IN}	Guaranteed by line-regulation test	$V_{OUT} + 0.2$		12.6	V	
Quiescent Supply Current	I_{IN}			27	35	μA	
Change in Supply Current	I_{IN}/V_{IN}	$(V_{OUT} + 0.2V) \leq V_{IN} \leq 12.6V$		0.8	2	$\mu A/V$	

MAX6190-MAX6195/MAX6198

Precision, Micropower, Low-Dropout Voltage References

MAX6190-MAX6195/MAX6198

ELECTRICAL CHARACTERISTICS—MAX6198

($V_{IN} = +5V$, $I_{OUT} = 0$, $T_A = T_{MIN}$ to T_{MAX} , unless otherwise noted. Typical values are at $T_A = +25^\circ C$.)

PARAMETER	SYMBOL	CONDITIONS	MIN	TYP	MAX	UNITS	
OUTPUT							
Output Voltage	V_{OUT}	$T_A = +25^\circ C$	MAX6198A	4.094	4.096	4.098	V
			MAX6198B	4.091	4.096	4.101	
			MAX6198C	4.086	4.096	4.106	
Output Voltage Temperature Coefficient (Note 1)	TCV_{OUT}	MAX6198A		2	5	ppm/ $^\circ C$	
		MAX6198B		4	10		
		MAX6198C		8	25		
Line Regulation	$\frac{\Delta V_{OUT}}{\Delta V_{IN}}$	$(V_{OUT} + 0.2V) \leq V_{IN} \leq 12.6V$		25	160	$\mu V/V$	
Load Regulation	$\frac{\Delta V_{OUT}}{\Delta I_{OUT}}$	Sourcing: $0 \leq I_{OUT} \leq 500\mu A$		0.15	0.70	$\mu V/\mu A$	
		Sinking: $-500\mu A \leq I_{OUT} \leq 0$		0.20	0.90		
Dropout Voltage (Note 4)	$V_{IN} - V_{OUT}$	$\Delta V_{OUT} \leq 0.2\%$, $I_{OUT} = 500\mu A$		100	200	mV	
Short-Circuit Current	I_{SC}	Short to GND		4		mA	
		Short to IN		4			
Temperature Hysteresis (Note 2)	$\Delta V_{OUT}/$ cycle			75		ppm	
Long-Term Stability	$\Delta V_{OUT}/$ time	1000hrs at $+25^\circ C$		50		ppm/ 1000hrs	
DYNAMIC							
Noise Voltage	e_{OUT}	0.1Hz to 10Hz		100		μV_{p-p}	
		10Hz to 10kHz		200		μV_{RMS}	
Ripple Rejection	V_{OUT}/V_{IN}	$V_{IN} = 5V \pm 100mV$, $f = 120Hz$		77		dB	
Turn-On Settling Time	t_R	To 0.1%, $C_{OUT} = 50pF$		160		μs	
Capacitive-Load Stability Range	C_{OUT}	(Note 3)	0		2.2	nF	
INPUT							
Supply Voltage Range	V_{IN}	Guaranteed by line-regulation test	$V_{OUT} + 0.2$		12.6	V	
Quiescent Supply Current	I_{IN}			27	35	μA	
Change in Supply Current	I_{IN}/V_{IN}	$(V_{OUT} + 0.2V) \leq V_{IN} \leq 12.6V$		0.8	2	$\mu A/V$	

Note 1: Temperature Coefficient is measured by the "box" method; i.e., the maximum ΔV_{OUT} is divided by the maximum Δt .

Note 2: Thermal Hysteresis is defined as the change in $+25^\circ C$ output voltage before and after cycling the device from T_{MIN} to T_{MAX} .

Note 3: Not production tested. Guaranteed by design.

Note 4: Dropout voltage is the minimum input voltage at which V_{OUT} changes $\leq 0.2\%$ from V_{OUT} at $V_{IN} = 5.0V$ ($V_{IN} = 5.5V$ for MAX6195).

Precision, Micropower, Low-Dropout Voltage References

Typical Operating Characteristics

($V_{IN} = +5V$ for MAX6190/1/2/3/4/8, $V_{IN} = +5.5V$ for MAX6195; $I_{OUT} = 0$; $T_A = +25^\circ C$; unless otherwise noted.) (Note 5)

MAX6190-MAX6195/MAX6198

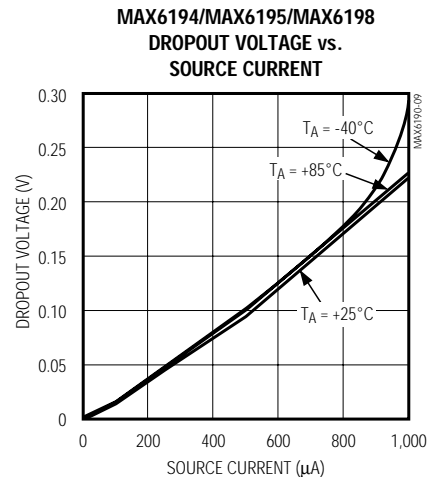
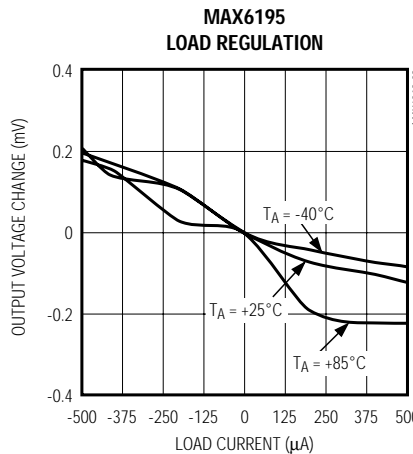
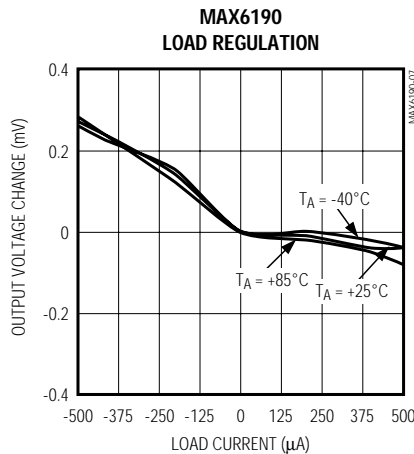
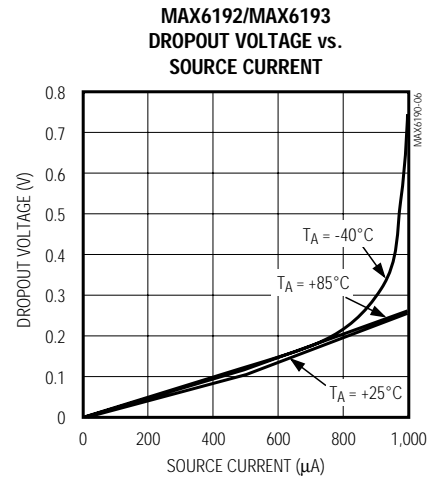
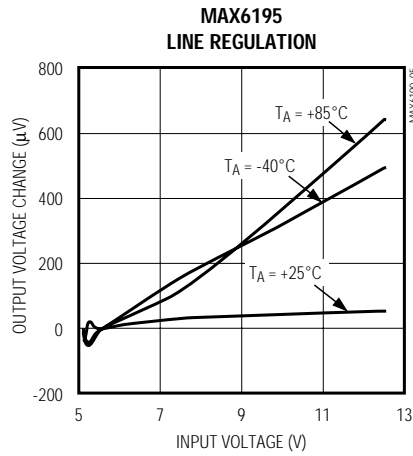
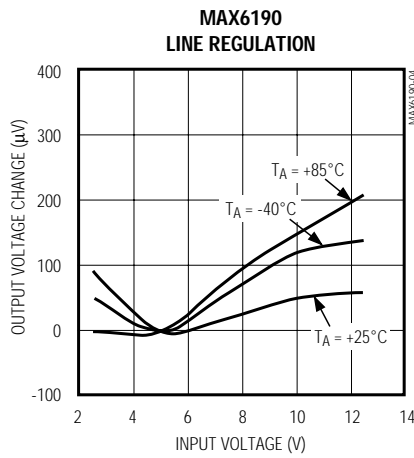
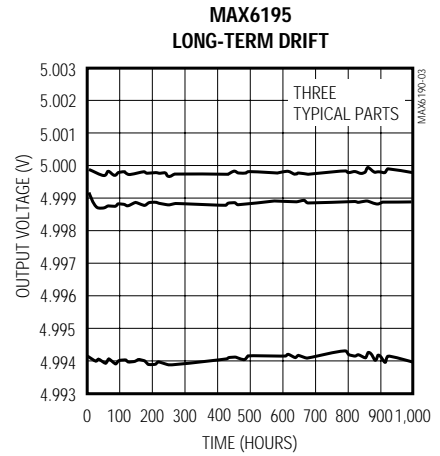
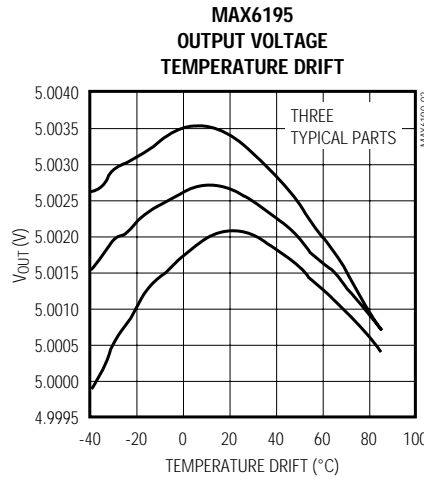
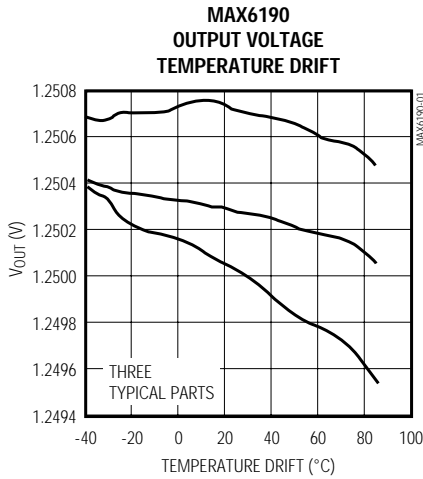

Precision, Micropower, Low-Dropout Voltage References

Typical Operating Characteristics (continued)

($V_{IN} = +5V$ for MAX6190/1/2/3/4/8, $V_{IN} = +5.5V$ for MAX6195; $I_{OUT} = 0$; $T_A = +25^\circ C$; unless otherwise noted.) (Note 5)

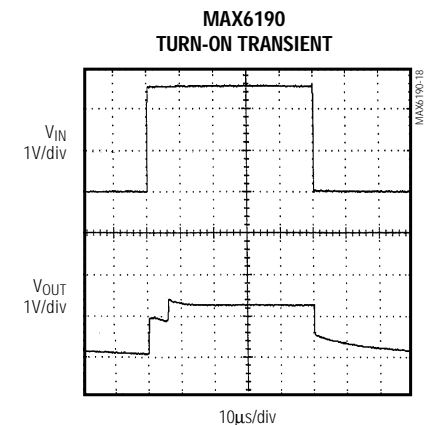
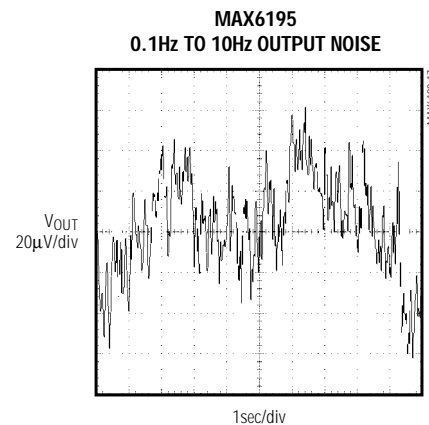
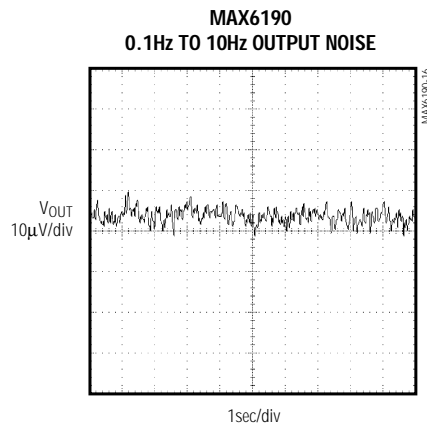
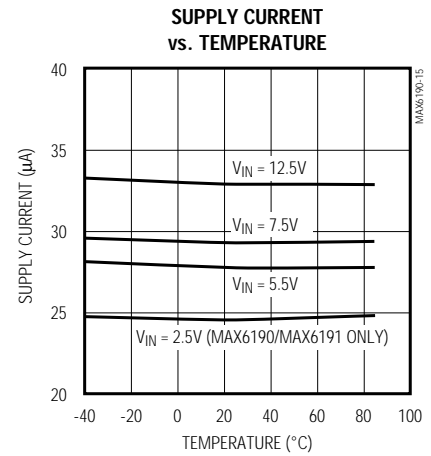
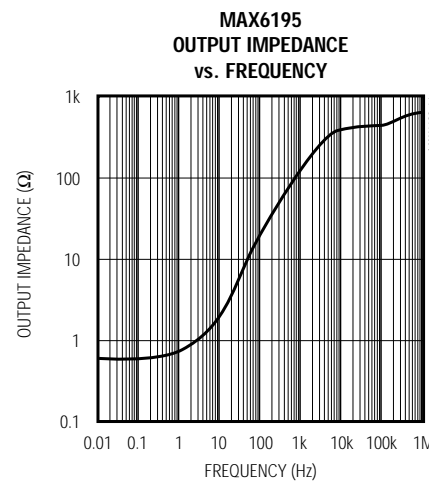
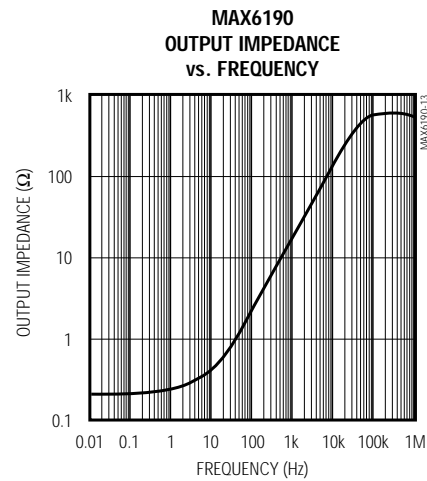
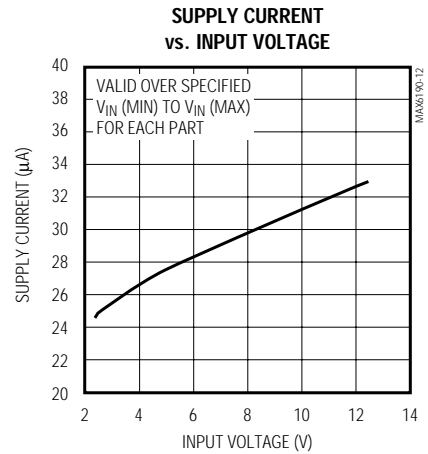
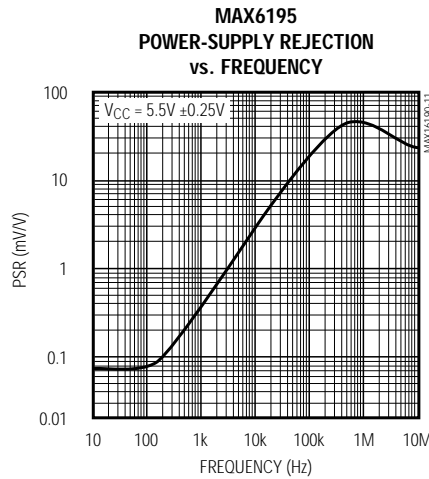
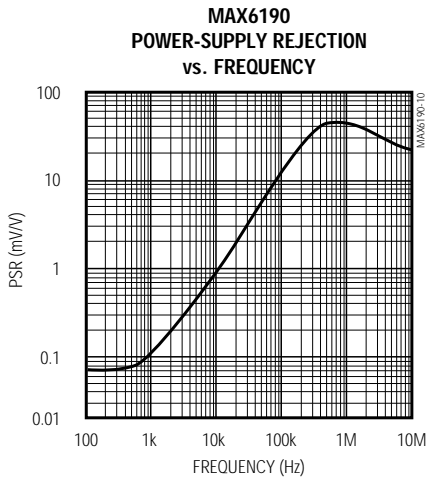

Precision, Micropower, Low-Dropout Voltage References

Typical Operating Characteristics (continued)

($V_{IN} = +5V$ for MAX6190/1/2/3/4/8, $V_{IN} = +5.5V$ for MAX6195; $I_{OUT} = 0$; $T_A = +25^\circ C$; unless otherwise noted.) (Note 5)

MAX6190-MAX6195/MAX6198

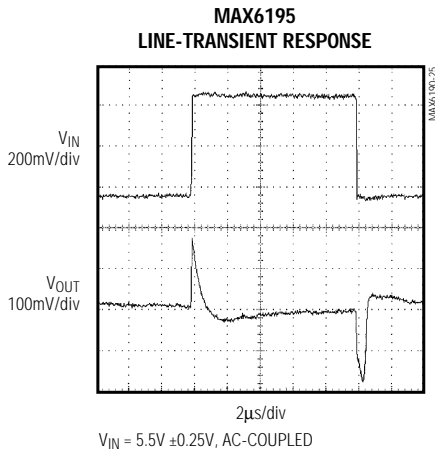
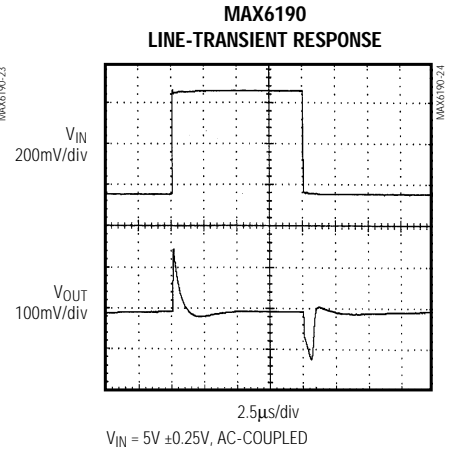
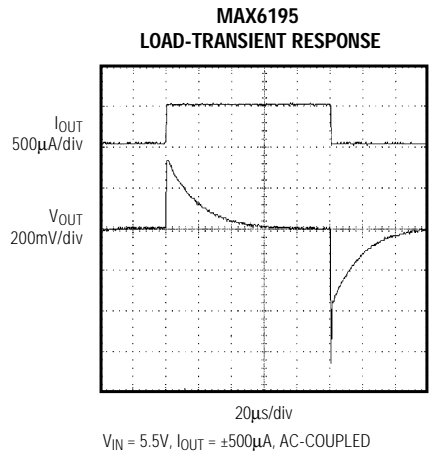
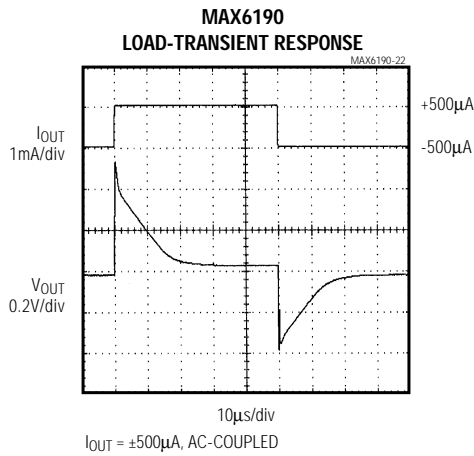
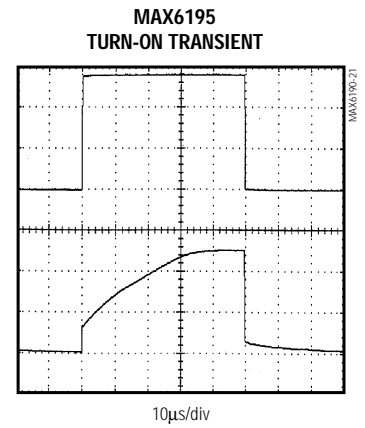
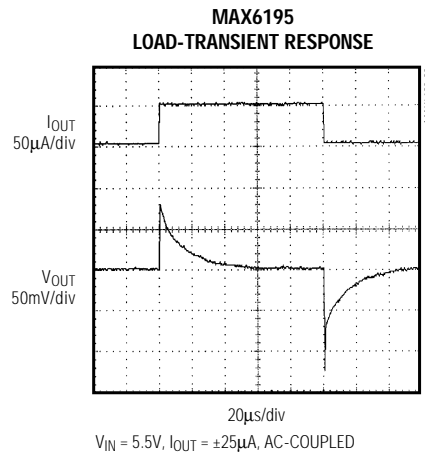
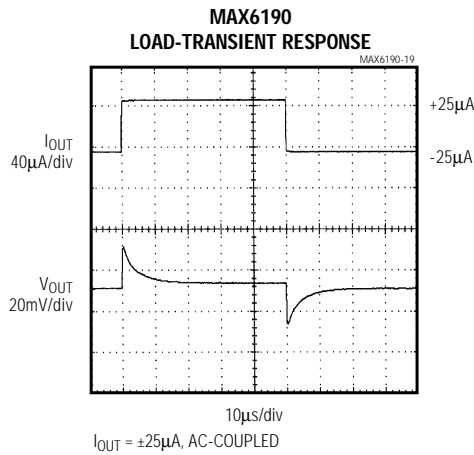

Note 5: Many of the *Typical Operating Characteristics* of the MAX6190 family are extremely similar. The extremes of these characteristics are found in the MAX6190 (1.2V output) and the MAX6195 (5.0V output) devices. The *Typical Operating Characteristics* of the remainder of the MAX6190 family typically lie between these two extremes and can be estimated based on their output voltage.

Precision, Micropower, Low-Dropout Voltage References

Pin Description

PIN	NAME	FUNCTION
1, 3, 5, 7, 8	N.C.	No Connection. Not internally connected.
2	IN	Supply Voltage Input
4	GND	Ground
6	OUT	Reference Voltage Output

Detailed Description

The MAX6190-MAX6195/MAX6198 precision bandgap references use a proprietary curvature-correction circuit and laser-trimmed thin-film resistors, resulting in a low temperature coefficient of <math><5\text{ppm}/^\circ\text{C}</math> and initial accuracy of better than 0.1%. These devices can sink and source up to 500 μA with <math><200\text{mV}</math> of dropout voltage, making them attractive for use in low-voltage applications.

Applications Information

Output/Load Capacitance

Devices in this family do not require an output capacitance for frequency stability. They are stable for capacitive loads from 0 to 2.2nF. However, in applications where the load or the supply can experience step changes, an output capacitor will reduce the amount of overshoot (or undershoot) and assist the circuit's transient response. Many applications do not need an external capacitor, and this family can offer a significant advantage in these applications when board space is critical.

Supply Current

The quiescent supply current of these series-mode references is a maximum of 35 μA and is virtually independent of the supply voltage, with only a 0.8 $\mu\text{A}/\text{V}$ variation with supply voltage. Unlike series references, shunt-mode references operate with a series resistor connected to the power supply. The quiescent current of a shunt-mode reference is thus a function of the input

voltage. Additionally, shunt-mode references have to be biased at the maximum expected load current, even if the load current is not present all the time. In the series-mode MAX6190 family, the load current is drawn from the input voltage only when required, so supply current is not wasted and efficiency is maximized at all input voltages. This improved efficiency can help reduce power dissipation and extend battery life.

When the supply voltage is below the minimum specified input voltage (as during turn-on), the devices can draw up to 200 μA beyond the nominal supply current. The input voltage source must be capable of providing this current to ensure reliable turn-on.

Output Voltage Hysteresis

Output voltage hysteresis is the change in the output voltage at $T_A = +25^\circ\text{C}$ before and after the device is cycled over its entire operating temperature range. Hysteresis is caused by differential package stress appearing across the bandgap core transistors. The typical temperature hysteresis value is 75ppm.

Turn-On Time

These devices typically turn on and settle to within 0.1% of their final value in 30 μs to 220 μs , depending on the device. The turn-on time can increase up to 1.5ms with the device operating at the minimum dropout voltage and the maximum load.

Positive and Negative Low-Power Voltage Reference

Figure 1 shows a typical method for developing a bipolar reference. The circuit uses a MAX681 voltage doubler/inverter charge-pump converter to power an ICL7652, thus creating a positive as well as a negative reference voltage.

Precision, Micropower, Low-Dropout Voltage References

MAX6190-MAX6195/MAX6198

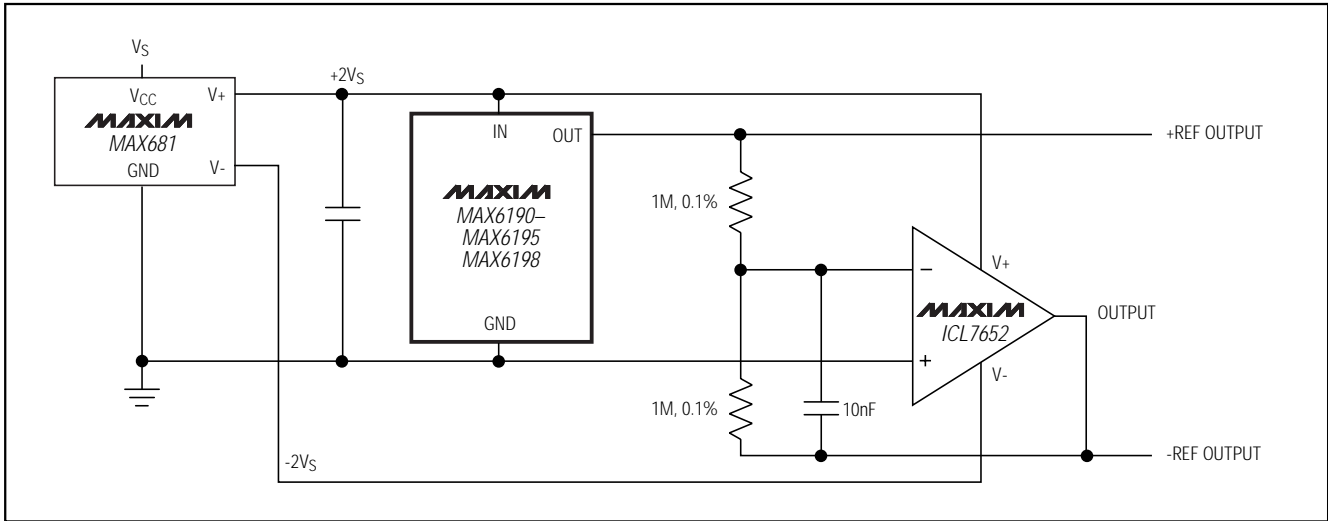
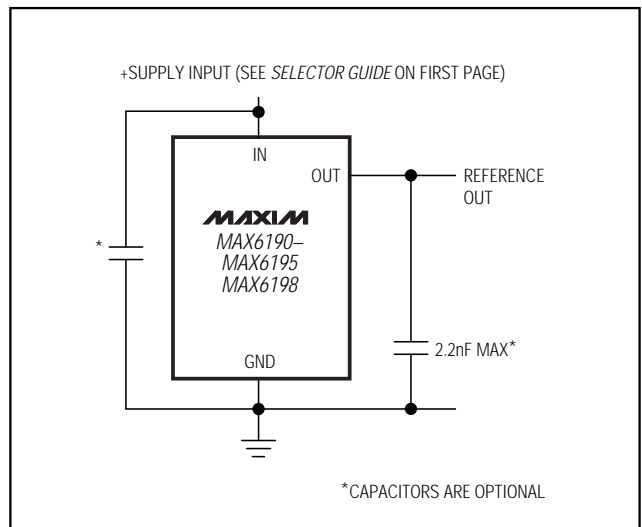

Figure 1. Positive and Negative References from Single +3V or +5V Supply

Ordering Information (continued)

PART	TEMP. RANGE	PIN-PACKAGE
MAX6193 AESA	-40°C to +85°C	8 SO
MAX6193BESA	-40°C to +85°C	8 SO
MAX6193CESA	-40°C to +85°C	8 SO
MAX6194 AESA	-40°C to +85°C	8 SO
MAX6194BESA	-40°C to +85°C	8 SO
MAX6194CESA	-40°C to +85°C	8 SO
MAX6195 AESA	-40°C to +85°C	8 SO
MAX6195BESA	-40°C to +85°C	8 SO
MAX6195CESA	-40°C to +85°C	8 SO
MAX6198 AESA	-40°C to +85°C	8 SO
MAX6198BESA	-40°C to +85°C	8 SO
MAX6198CESA	-40°C to +85°C	8 SO

Typical Operating Circuit



Chip Information

TRANSISTOR COUNT: 70

Precision, Micropower, Low-Dropout Voltage References

Package Information

	INCHES		MILLIMETERS	
	MIN	MAX	MIN	MAX
A	0.053	0.069	1.35	1.75
A1	0.004	0.010	0.10	0.25
B	0.014	0.019	0.35	0.49
C	0.007	0.010	0.19	0.25
e	0.050		1.27	
E	0.150	0.157	3.80	4.00
H	0.228	0.244	5.80	6.20
h	0.010	0.020	0.25	0.50
L	0.016	0.050	0.40	1.27

	INCHES		MILLIMETERS		N	MS012
	MIN	MAX	MIN	MAX		
D	0.189	0.197	4.80	5.00	8	A
D	0.337	0.344	8.55	8.75	14	B
D	0.386	0.394	9.80	10.00	16	C

NOTES:
 1. D&E DO NOT INCLUDE MOLD FLASH
 2. MOLD FLASH OR PROTRUSIONS NOT TO EXCEED .15mm (.006")
 3. LEADS TO BE COPLANAR WITHIN .102mm (.004")
 4. CONTROLLING DIMENSION: MILLIMETER
 5. MEETS JEDEC MS012-XX AS SHOWN IN ABOVE TABLE
 6. N = NUMBER OF PINS

SOIC195

MAXIM PACKAGE FAMILY OUTLINE: SOIC .150" 1/1 21-0041 A
130 SAN CARLOS, OR SAN JOSE, CA 95050, FAX (408) 737-7704 PROPRIETARY INFORMATION TITLE DOCUMENT CONTROL NUMBER REV

*Precision, Micropower,
Low-Dropout Voltage References*

NOTES

MAX6190-MAX6195/MAX6198

Precision, Micropower, Low-Dropout Voltage References

NOTES

MAX6190-MAX6195/MAX6198

Maxim cannot assume responsibility for use of any circuitry other than circuitry entirely embodied in a Maxim product. No circuit patent licenses are implied. Maxim reserves the right to change the circuitry and specifications without notice at any time.

16 _____ Maxim Integrated Products, 120 San Gabriel Drive, Sunnyvale, CA 94086 408-737-7600

© 1999 Maxim Integrated Products

Printed USA

MAXIM is a registered trademark of Maxim Integrated Products.