



5V/3.3V/3V/Adjustable-Output, Step-Up/Step-Down DC-DC Converters

General Description

The MAX877/MAX878/MAX879 are pulse-skipping, step-up/step-down DC-DC converters that provide a regulated output from inputs both above and below the output. They require only three external components—an inductor (typically 22 μ H) and two filter capacitors.

The MAX877 delivers a regulated 5V output from 2.5V to 6.2V inputs. The MAX878 generates pin-selectable voltages of 3.0V or 3.3V from 1.5V to 6.2V inputs. The MAX879 output can be adjusted from 2.5V to 6V via an external resistor divider from 2.5V to 6V inputs.

A unique high-power, internal, synchronous rectifier design (Active Rectifier™) enables the devices to regulate in a switched linear mode if the input voltage is higher than the desired output voltage. When the input voltage falls below the output voltage, the MAX877/MAX878/MAX879 will smoothly switch into a pulse-skipping boost mode and step up from input voltages as low as 1V. In shutdown, the active rectifier disconnects the output from the source. This stops the current drain from input to output associated with conventional step-up converters.

High-frequency operation (up to 300kHz) allows the use of small surface-mount inductors. Supply current is 195 μ A under no load, and only 20 μ A in shutdown mode. For 1-cell (1V) step-up converters with similar performance and the same pinout, refer to the MAX777/MAX778/MAX779 data sheet.

Applications

Two or Three NiCd Cells to 3V/3.3V Conversion
Three or Four Alkaline Cells to 5V Conversion
One Lithium Cell to 3V/3.3V Conversion
Pagers
Palmtop and Notebook Computers
Battery-Powered and Hand-Held Instruments

Pin Configuration

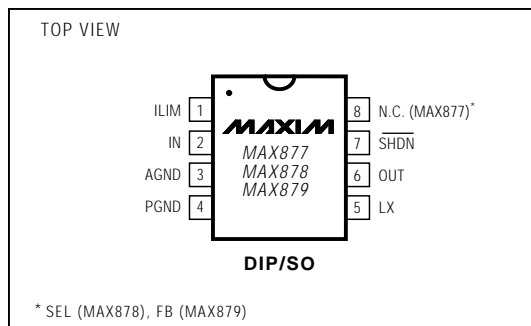

™ Active Rectifier is a trademark of Maxim Integrated Products.

Features

- ◆ Regulates from Inputs Above & Below the Output
- ◆ 1V to 6.2V Supply-Voltage Range
- ◆ Internal 1A Active Rectifier with Input-to-Output Disconnect in Shutdown
- ◆ Up to 210mA Load Currents, Guaranteed
- ◆ 85% Efficiency
- ◆ Only 3 External Components
- ◆ Adjustable Current Limit
- ◆ 195 μ A Quiescent Supply Current
- ◆ 20 μ A Shutdown Supply Current
- ◆ 3V/3.3V/5V and Adjustable Output Voltage Versions
- ◆ Available in 8-Pin DIP and SO Packages

Ordering Information

PART	TEMP. RANGE	PIN-PACKAGE
MAX877CPA	0°C to +70°C	8 Plastic DIP
MAX877CSA	0°C to +70°C	8 SO
MAX877C/D	0°C to +70°C	Dice*
MAX877EPA	-40°C to +85°C	8 Plastic DIP
MAX877ESA	-40°C to +85°C	8 SO
MAX877MJA	-55°C to +125°C	8 CERDIP

Ordering Information continued on last page.

* Contact factory for dice specifications.

Typical Operating Circuit

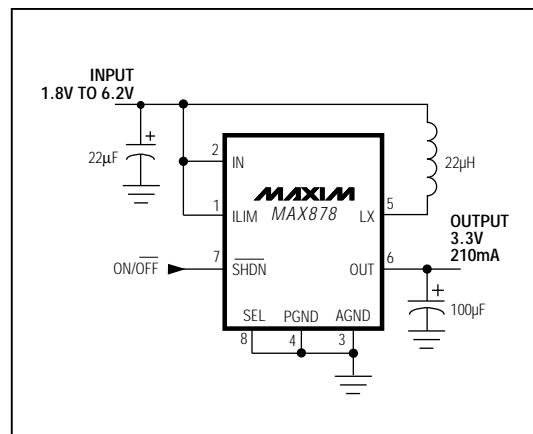

MAX877/MAX878/MAX879

5V/3.3V/3V/Adjustable-Output, Step-Up/Step-Down DC-DC Converters

ABSOLUTE MAXIMUM RATINGS

Supply Voltage (IN to PGND)	0V to +7V
Output Short-Circuit Duration to PGND, AGND (Note 1).....	30sec
Voltage Applied to:	
LX (switch off).....	-0.3V to +7V
(switch on).....	30sec short to IN or OUT
OUT, SHDN.....	-0.3V to +7V
FB	-0.3V to (OUT + 0.3V)
AGND to PGND	-0.3V, +0.3V
Reverse Battery Current.....	900mA

Continuous Power Dissipation (T _A = +70°C)	
Plastic DIP (derate 9.09mW/°C above +70°C)	727mW
SO (derate 5.88mW/°C above +70°C)	471mW
CERDIP (derate 8.00mW/°C above +70°C)	640mW
Operating Temperature Ranges:	
MAX87_C_A	0°C to +70°C
MAX87_E_A	-40°C to +85°C
MAX87_MJA	-55°C to +125°C
Storage Temperature Range	-65°C to +150°C
Lead Temperature (soldering, 10sec)	+300°C

Note 1: The output may be shorted to ground continuously if the package power dissipation is not exceeded.

Stresses beyond those listed under "Absolute Maximum Ratings" may cause permanent damage to the device. These are stress ratings only, and functional operation of the device at these or any other conditions beyond those indicated in the operational sections of the specifications is not implied. Exposure to absolute maximum rating conditions for extended periods may affect device reliability.

ELECTRICAL CHARACTERISTICS

(V_{IN} = 2.7V, I_{LOAD} = 0mA, LX = 22μH, C_{OUT} = 100μF, SHDN and ILIM connected to IN, AGND connected to PGND, T_A = T_{MIN} to T_{MAX}, typical values are at T_A = +25°C, unless otherwise noted.)

PARAMETER		CONDITIONS	MIN	TYP	MAX	UNITS	
Minimum Start-Up Voltage (Notes 2, 6)		I _{LOAD} = 0mA, T _A = +25°C		1		V	
		MAX877/MAX879 (V _{OUT} = 5V), 0mA < I _{LOAD} < 180mA, T _A = +25°C			2.5		
		MAX878/MAX879 (V _{OUT} = 3.3V), 0mA < I _{LOAD} < 120mA, T _A = +25°C			1.5		
Maximum Operating Voltage		(Notes 2, 3)	6.2			V	
Output Voltage (MAX879 set to 5V) (Note 3)		MAX877C/MAX879C: 0mA ≤ I _{LOAD} ≤ 240mA, 2.7V ≤ V _{IN} ≤ 6.2V; MAX877E/MAX879E: 0mA ≤ I _{LOAD} ≤ 220mA, 2.7V ≤ V _{IN} ≤ 6.2V; MAX877M/MAX879M: 0mA ≤ I _{LOAD} ≤ 180mA, 2.7V ≤ V _{IN} ≤ 6.2V	4.80	5.00	5.20	V	
Output Voltage (MAX879 set to 3.3V) (Note 3)	SEL = 0V	MAX878C/MAX879C: 0mA ≤ I _{LOAD} ≤ 210mA, 1.8V ≤ V _{IN} ≤ 6.2V; MAX878E/MAX879E: 0mA ≤ I _{LOAD} ≤ 200mA, 1.8V ≤ V _{IN} ≤ 6.2V; MAX878M/MAX879M: 0mA ≤ I _{LOAD} ≤ 180mA, 1.8V ≤ V _{IN} ≤ 6.2V	3.17	3.30	3.43	V	
	SEL = Open	MAX878C: 0mA ≤ I _{LOAD} ≤ 210mA, 1.8V ≤ V _{IN} ≤ 6.2V; MAX878E: 0mA ≤ I _{LOAD} ≤ 200mA, 1.8V ≤ V _{IN} ≤ 6.2V; MAX878M: 0mA ≤ I _{LOAD} ≤ 180mA, 1.8V ≤ V _{IN} ≤ 6.2V	2.88	3.00	3.12		
Output Voltage Range		MAX879, I _{LOAD} = 0mA (Note 4)	2.5		6.0	V	
Efficiency		MAX877/MAX879 (V _{OUT} = 5V), I _{LOAD} = 100mA, V _{IN} = 4V		85		%	
		MAX878/MAX879 (V _{OUT} = 3.3V), I _{LOAD} = 100mA, V _{IN} = 2.5V		82			
No-Load Supply Current		I _{LOAD} = 0mA (switch off)		195	310	μA	
Shutdown Supply Current		SHDN = 0V	MAX87_C, MAX87_E		20	30	μA
			MAX87_M		20	35	
SHDN Bias Current		0V < SHDN < V _{IN}		15	100	nA	
		V _{IN} < SHDN < 5V		12	40	μA	

5V/3.3V/3V/Adjustable-Output, Step-Up/Step-Down DC-DC Converters

ELECTRICAL CHARACTERISTICS (continued)

($V_{IN} = 2.7V$, $I_{LOAD} = 0mA$, $LX = 22\mu H$, $C_{OUT} = 100\mu F$, \overline{SHDN} and $ILIM$ connected to IN , $AGND$ connected to $PGND$, $T_A = T_{MIN}$ to T_{MAX} , typical values are at $T_A = +25^\circ C$, unless otherwise noted.)

PARAMETER	CONDITIONS	MIN	TYP	MAX	UNITS
\overline{SHDN} Threshold	$V_{IN} = 1V$ to $6.2V$	$V_{IN}/2 + 0.25$			V
	$V_{IN} = 2.7V$	1.3		1.7	
\overline{SHDN} Enable Delay			150		μs
Current Limit			1.0		A
Current-Limit Temperature Coefficient			-0.3		$\%/^\circ C$
Switch Saturation Voltage	$I_{SW} = 400mA$		0.275		V
	$I_{SW} = 600mA$		0.33		
	$I_{SW} = 1000mA$		0.50		
Maximum Switch On Time	$V_{IN} = 2.5V$		4.0		μs
	$V_{IN} = 1.8V$		5.9		
	$V_{IN} = 1V$		12.6		
Minimum Switch Off Time	MAX877/MAX879		1.3		μs
	MAX878		2.3		
Rectifier Forward Voltage Drop	$I_{SW} = 400mA$		0.21		V
	$I_{SW} = 600mA$		0.31		
	$I_{SW} = 1000mA$		0.50		
Error-Comparator Trip Point (V_{REF})	MAX879, $V_{IN} = 1.8V$ to $5V$ (Note 5)	197.5	202.5	207.5	mV
FB Pin Bias Current	MAX879		10	40	nA
Switch Off Leakage Current			0.1		μA
Rectifier Off Leakage Current			0.1		μA

Note 2: Output in regulation, $V_{OUT} = V_{OUT}(\text{nominal}) \pm 4\%$.

Note 3: At high V_{IN} to V_{OUT} differentials, the maximum load current is limited by the maximum allowable power dissipation in the package (see *Absolute Maximum Ratings* and Maximum Output Current graphs in the *Typical Operating Characteristics*).

Note 4: Minimum value is production tested. Maximum value is guaranteed by design and is not production tested.

Note 5: V_{OUT} is set to a target value of $5V$ by 0.1% external feedback resistors. V_{OUT} is measured to be within $5V \pm 2.5\%$ to guarantee error-comparator trip point.

Note 6: Startup guaranteed under these load conditions.

MAX877/MAX878/MAX879

5V/3.3V/3V/Adjustable-Output, Step-Up/Step-Down DC-DC Converters

Typical Operating Characteristics

(Circuit of Figure 4, $T_A = +25^\circ\text{C}$, unless otherwise noted.)

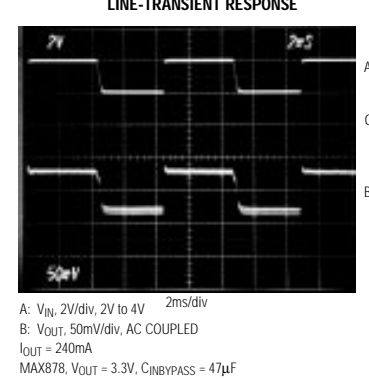
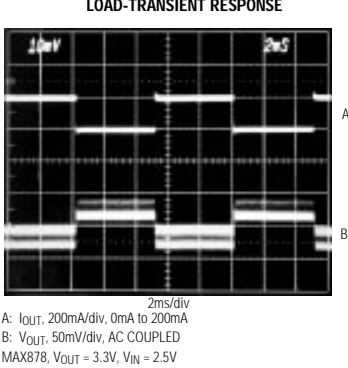
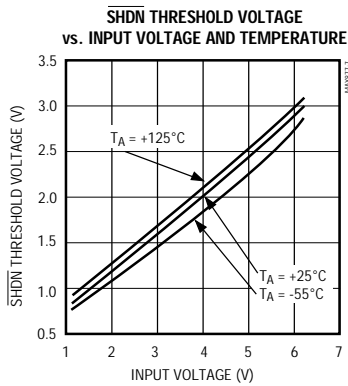
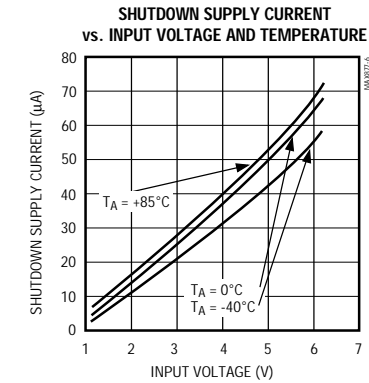
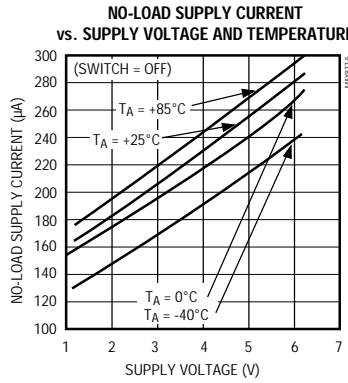
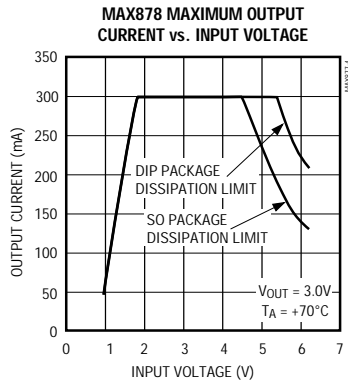
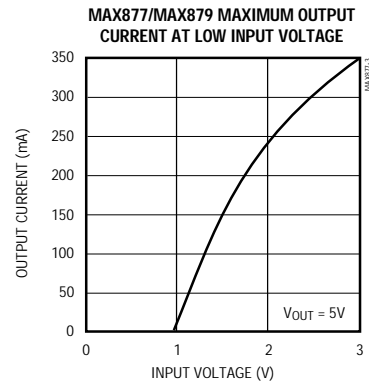
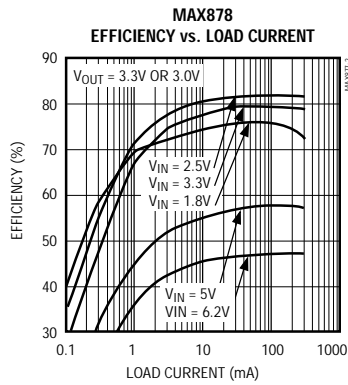
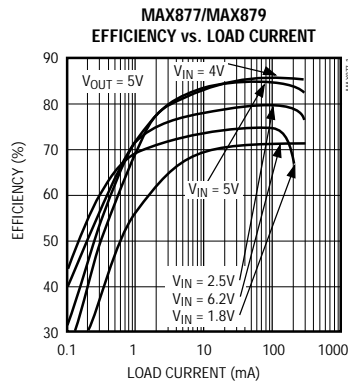

5V/3.3V/3V/Adjustable-Output, Step-Up/Step-Down DC-DC Converters

Typical Operating Characteristics (continued)

(Circuit of Figure 4, $T_A = +25^\circ\text{C}$, unless otherwise noted.)

MAX877/MAX878/MAX879

**SWITCHING WAVEFORMS—
CONTINUOUS CONDUCTION**

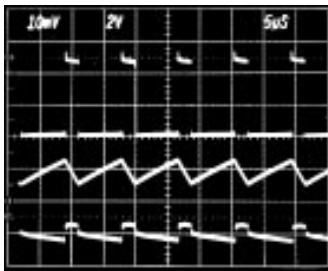

A: SWITCH VOLTAGE (LX PIN), 2V/div
B: INDUCTOR CURRENT, 0.5A/div
C: OUTPUT VOLTAGE RIPPLE, 50mV/div
MAX877, $V_{IN} = 1.5\text{V}$, $I_{OUT} = 100\text{mA}$

**SWITCHING WAVEFORMS—
DISCONTINUOUS CONDUCTION**

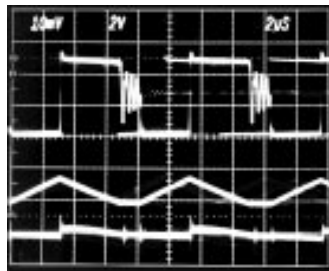

A: SWITCH VOLTAGE (LX PIN), 2V/div
B: INDUCTOR CURRENT, 0.5A/div
C: OUTPUT VOLTAGE RIPPLE, 50mV/div
MAX877, $V_{IN} = 3\text{V}$, $I_{OUT} = 70\text{mA}$

STEP-DOWN CONVERSION

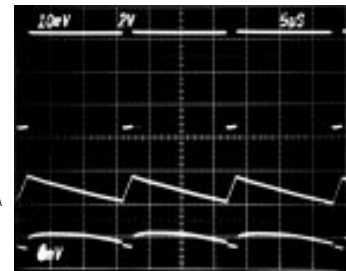

A: SWITCH VOLTAGE (LX PIN), 2V/div
B: INDUCTOR CURRENT, 0.5A/div
C: OUTPUT VOLTAGE RIPPLE, 50mV/div
MAX878, $V_{IN} = 6.0\text{V}$, $V_{OUT} = 5.0\text{V}$, $I_{OUT} = 210\text{mA}$

**STEP-UP/STEP-DOWN
OPERATION**

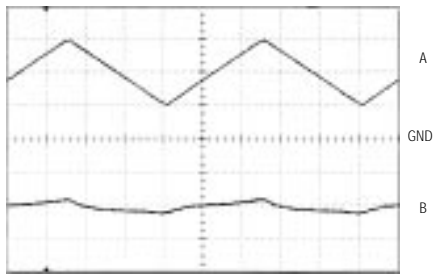

A: INPUT VOLTAGE, 2V/div, 2V to 6V
B: OUTPUT VOLTAGE, 50mV/div
MAX878, $I_{OUT} = 100\text{mA}$, $V_{OUT} = 3.3\text{V}$

**MAX878
START-UP TIME**

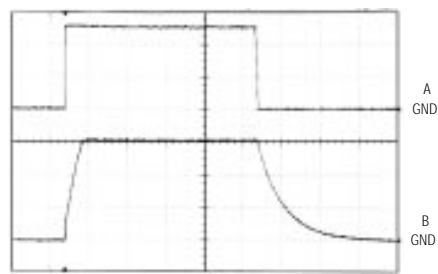

A: SHDN, 2V/div
B: V_{OUT} , 1V/div
 $V_{OUT} = 3\text{V}$

5V/3.3V/3V/Adjustable-Output, Step-Up/Step-Down DC-DC Converters

Pin Description

PIN	NAME	FUNCTION
1	ILIM	Sets switch current-limit input. Connect to IN for 1A current limit. A resistor from ILIM to IN sets lower peak inductor currents.
2	IN	Input supply.
3	AGND	Analog ground. Not internally connected to PGND.
4	PGND	Power ground must be low impedance: solder directly to ground plane or star ground. Connect to AGND, close to the device.
5	LX	1A NPN power switch collector and active-rectifier PNP emitter.
6	OUT	Voltage output. Connect filter capacitor close to pin.
7	$\overline{\text{SHDN}}$	Shutdown input disables power supply when low. Also disconnects load from input. Threshold is set at $V_{\text{IN}}/2$. Connect to IN for normal operation.
8	N.C. (MAX877)	No connect, not internally connected.
	SEL (MAX878)	Selects the main output voltage: 3.3V when connected to AGND, 3.0V when left open.
	FB (MAX879)	Feedback input for adjustable-output operation. Connect to an external voltage divider between V_{OUT} and AGND.

Detailed Description

Operating Principle

The MAX877/MAX878/MAX879 combine a switch-mode regulator with an NPN bipolar power switch and current limit, a precision voltage reference, and a synchronous rectifier—all in a single monolithic device. In shutdown mode, the internal rectifier is completely turned off and disconnects the load from the source. Only two external components are required in addition to the input bypass capacitor—a 22 μH inductor, and a 100 μF filter capacitor.

A minimum-off-time, current-limited, pulse-frequency-modulation (PFM) control scheme combines the high output power and efficiency of pulse-width modulation (PWM) with the low quiescent currents of traditional PFM pulse skippers.

External conditions (inductor value, load, and input voltage) determine the way the converter operates, as follows:

At light loads, the current through the inductor starts at zero, rises to a peak value, and drops down to zero in each cycle (discontinuous-conduction mode). In this case, the switching frequency is governed by a pair of one-shots, which set a maximum on-time inversely pro-

portional to V_{IN} [$t_{\text{ON}} = 8.8/(V_{\text{IN}} - 0.25)$] and a minimum off-time (1.3 μs for MAX877/MAX879, or 2.3 μs for MAX878). With a 22 μH inductor, LX's peak current is about 400mA and is independent of input voltage. Efficiency at light loads is improved because of lower peak currents.

At very light loads, more energy is stored in the coil than is required by the load in each cycle. The converter regulates by skipping entire cycles. Efficiency is typically 65% to 75% in the pulse-skipping mode. Pulse-skipping waveforms can be irregular, and the output waveform contains a low-frequency component. Larger, low equivalent-series-resistance (ESR) filter capacitors can help reduce the ripple voltage if needed.

At heavy loads above approximately 100mA, the converter enters continuous-conduction mode, where current always flows in the inductor. The switch ON state is controlled on a cycle-by-cycle basis, either by the $t_{\text{ON(max)}}$ time or the preset current limit in the switch. This prevents exceeding the switch current rating or saturating the inductor. At very heavy loads, the inductor current self-oscillates between this peak current limit and some lower value governed by the minimum off-time, the inductance value, and the input/output differential.

5V/3.3V/3V/Adjustable-Output, Step-Up/Step-Down DC-DC Converters

MAX877/MAX878/MAX879

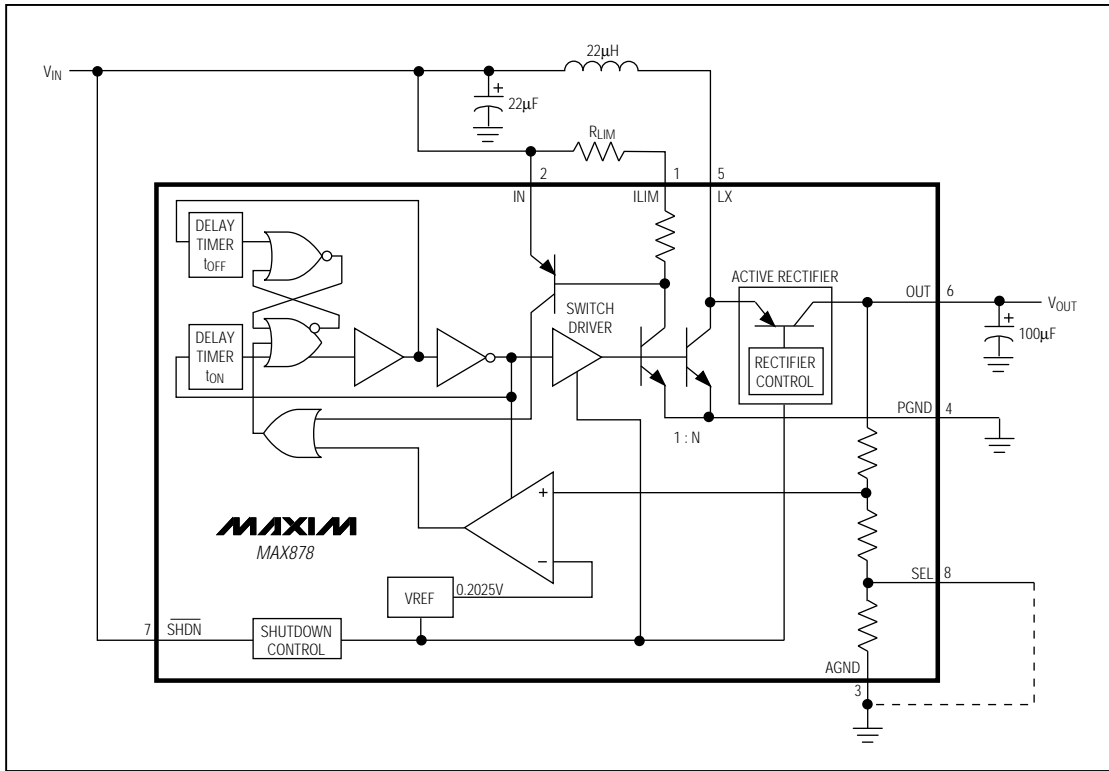

Figure 1. MAX878 Block Diagram

With ILIM shorted to IN, the peak switch current of the internal NPN power switch is set to 1A. It can be set to a lower value by connecting a resistor between ILIM and IN (see *Current Limit* section). This enables the use of physically smaller inductors with lower saturation-current ratings. At 1A, the switch voltage drop (V_{SW}) is about 500mV. V_{SW} decreases to about 250mV at 0.1A. Conventional PWM converters generate constant-frequency switching noise, while this architecture produces variable-frequency switching noise. The output ripple is the product of the peak inductor current and the output capacitor's ESR. Unlike conventional pulse-skippers, the MAX877/MAX878/MAX879 peak currents are scaled down at light loads, resulting in lower output ripple.

Step-Down Mode and Power Dissipation
In battery-powered applications, for example, where the input voltage exceeds the output voltage, the MAX877/MAX878/MAX879 behave as "switched" linear regulators. If the output voltage starts to drop, the switch turns on and energy is stored in the coil, as in normal step-up mode. After the switch turns off, the voltage at LX flies high. The active rectifier turns on when LX rises above V_{IN} . As in a linear regulator, the voltage difference between V_{IN} and V_{OUT} appears across the rectifier (actually a PNP transistor) until the current goes to zero and the rectifier turns off. At high V_{IN} to V_{OUT} differentials, the maximum load current is limited by the maximum allowable power dissipation in the package (see *Typical Operating Characteristics*).

5V/3.3V/3V/Adjustable-Output, Step-Up/Step-Down DC-DC Converters

Active Rectifier

The internal active rectifier of the MAX877/MAX878/MAX879 replaces the external Schottky catch diode in normal boost operation. The rectifier consists of a PNP pass transistor and a unique control circuit which, in shutdown mode, entirely disconnects the load from the source. This is a distinct advantage over standard boost topologies, since it prevents battery drain in shutdown. The MAX877/MAX878/MAX879 can withstand a momentary short at the output in normal operation.

The active rectifier also acts as a zero-dropout regulator if the input exceeds the regulated output. The device still switches to deliver power to the output, and the difference between the input and output voltage appears across the rectifier. Efficiency is similar to that of a linear regulator if the MAX877/MAX878/MAX879 are used as step-down converters. The maximum output current ($I_{OUT(MAX)}$) with larger input/output differentials is determined by package power dissipation. $I_{OUT(MAX)}$ can be approximated by:

$$I_{OUT(MAX)} \approx \left(\frac{P_{DISS}}{(V_{IN} - V_{OUT})} \right) \times 0.9$$

Shutdown

Shutdown (\overline{SHDN}) is a high-impedance, active-low input. Connect it to IN for normal operation. Keeping \overline{SHDN} at ground holds the converters in shutdown mode. Since the active rectifier is turned off in this mode, the path from input to load is cut, and the output effectively drops to 0V. The supply current in shutdown mode ranges from 4 μ A at $V_{IN} = 1V$ to 50 μ A at $V_{IN} = 5V$. The shutdown-circuit threshold is set nominally to $V_{IN}/2 + 250mV$. When \overline{SHDN} is below this threshold, the device is shut down; it is enabled with \overline{SHDN} above the threshold. When driven from external logic, \overline{SHDN} can be driven to a higher voltage than V_{IN} , (6.2V max).

Current Limit

Connecting ILIM to IN sets an LX current limit of 1A. For smaller output power levels that do not require the maximum peak current, reduce the peak inductor current by connecting a resistor between ILIM and IN. This optimizes overall efficiency and allows very small, low-cost coils with lower current ratings. See Figure 2 to select the resistor (see also *Inductor Selection* section).

Output Voltage Selection

The MAX877's output voltage is fixed at 5V. The MAX878's output voltage can be set to 3V by leaving the SEL pin open, or to 3.3V by connecting SEL to AGND.

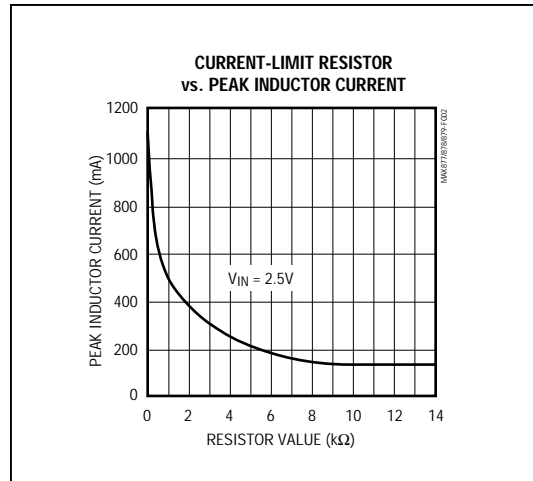

Figure 2. Current-Limit Resistor vs. Peak Inductor Current

The MAX879's output voltage is set by two resistors, R1 and R2 (Figure 3), which form a voltage divider between the output and the FB pin. The output voltage can be set from 2.5V to 6.0V by the equation:

$$V_{OUT} = V_{REF} \frac{(R1 + R2)}{R2}$$

where $V_{REF} = 0.2025V$.

To simplify the resistor selection:

$$R1 = R2 \left(\frac{V_{OUT}}{V_{REF}} - 1 \right)$$

Since the input current at FB has a maximum of 40nA, large values (10k Ω to 50k Ω for R2) can be used without significant accuracy loss. For 1% error, the current through R2 should be at least 100 times FB's bias current.

When large values are used for the feedback resistors ($R1 > 50k\Omega$), stray output impedance at FB can add a "lag" to the feedback response, destabilizing the regulator and creating a larger ripple at the output. Lead lengths and circuit board traces at the FB node should be kept short. Reduce ripple by adding a "lead" compensation capacitor (C3, 100pF to 50nF) in parallel with R1.

5V/3.3V/3V/Adjustable-Output, Step-Up/Step-Down DC-DC Converters

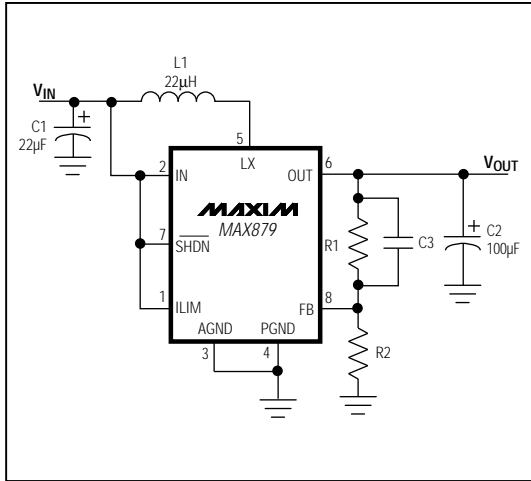

Figure 3. MAX879 Adjustable Voltage

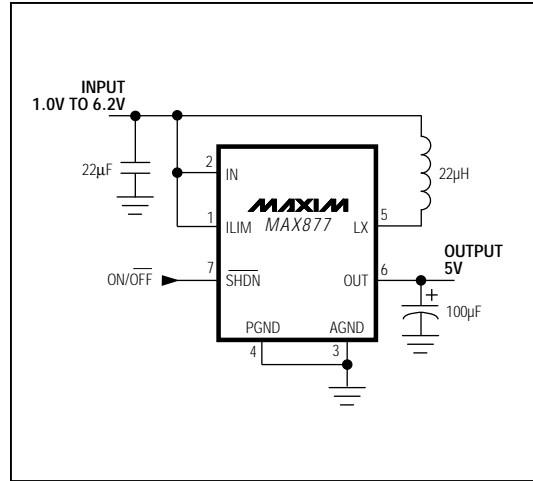

Figure 4. MAX877 Standard Application Circuit

MAX877/MAX878/MAX879

Applications Information

Figure 4 shows a MAX877 step-up application circuit. This circuit starts up and operates with inputs ranging from 1.0V to 6.2V. Start-up time is a function of the load, typically less than 5ms. Output current capability is a function of the input voltage (see *Typical Operating Characteristics*).

The converters will regulate down to the output voltage and seamlessly switch into boost mode as the input drops below the output voltage. This is especially useful in battery-powered applications, where the battery voltage may initially exceed the output voltage. To generate 5V from four alkaline cells in series, the input ranges from 6.2V to 3.6V. When the battery pack is fresh, the MAX877 will step down with the active rectifier acting as the switch. As the batteries approach 5V, or the desired output voltage, the converter's control circuitry will ensure a smooth transition into step-up mode. The converter operates until the batteries are less than 3V; efficiency is typically 80% with fresh batteries, and is close to 85% at $V_{IN} = 4V$.

Inductor Selection

The 22µH inductor shown in the *Typical Operating Circuit* is sufficient for most MAX877/MAX878/MAX879 designs. Other inductor values ranging from 10µH to 47µH are also suitable. The inductor should have a saturation rating equal to or greater than the peak switch-

current limit, which is 1A without an external current limit (ILIM connected to IN). It is acceptable to operate the inductor at 120% of its saturation rating; however, this may slightly reduce efficiency. For highest efficiency, use an inductor with a low **DC resistance**, preferably under 0.2Ω. Table 1 lists suggested inductor suppliers.

Capacitor Selection

The 100µF, 10V surface-mount tantalum (SMT) output capacitor shown in the *Typical Operating Circuit* will provide a 25mV output ripple or less, stepping up from 3V to 5V at 200mA. Smaller capacitors, down to 10µF, are acceptable for light loads or in applications that can tolerate higher output ripple. The input capacitor may be omitted if the supply has low output impedance and the input lead length is less than 2 inches (5cm) or the loads are small.

The primary factor in selecting both the output and input filter capacitor is low ESR. The ESR of both bypass and filter capacitors affects efficiency. Optimize performance by increasing filter capacitors or using specialized low-ESR capacitors. The smallest low-ESR SMT tantalum capacitors currently available are Sprague 595D or 695D series. Sanyo OS-CON organic-semiconductor through-hole capacitors also exhibit very low ESR, are rated for the wide temperature range, and are especially suitable for operation at cold temperatures (below 0°C).

Table 1 lists suggested capacitor suppliers.

5V/3.3V/3V/Adjustable-Output, Step-Up/Step-Down DC-DC Converters

Layout

The MAX877/MAX878/MAX879's high peak currents and high-frequency operation make PC layout important for minimum ground bounce and noise. Locate input bypass and output filter capacitors close to the device pins. All connections to the FB pin (MAX879)

should also be kept as short as possible. A ground plane is recommended. Solder AGND (pin 3) and PGND (pin 4) directly to the ground plane. Refer to the MAX877/MAX878/MAX879 evaluation kit (EV kit) manual for a suggested surface-mount layout.

Table 1. Component Suppliers

PRODUCTION METHOD	INDUCTORS	CAPACITORS
Surface Mount	Sumida CD54-220 (22μH) Murata-Erie LQHYN1501K04M00-D5 (15μH) CoilCraft DO3316-223 (22μH) Coiltronics CTX20-1 (22μH)	Sprague 595D Sprague 695D Matsuo 267 series AVX TPS series
Miniature Through-Hole	Sumida RCH654-220 (22μH)	Sanyo OS-CON (low-ESR organic semiconductor)
Low-Cost Through-Hole	Renco RL 1284-22 (22μH) CoilCraft PCH-27-223 (22μH)	Nichicon PL series (low-ESR electrolytic) United Chemi-Con LXF series

AVX	USA:	(207) 282-5111	FAX (207) 283-1941
CoilCraft	USA:	(708) 639-6400	FAX (708) 639-1469
Coiltronics	USA:	(407) 241-7876	FAX (407) 241-9339
Matsuo	USA:	(714) 969-2491	FAX (714) 960-6492
	Japan:	(06) 332-0871	
Murata-Erie	USA:	(800) 831-9172	FAX (814) 238-0490
Nichicon	USA:	(708) 843-7500	FAX (708) 843-2798
	Japan:	(81) 7-5231-8461	FAX (81) 7-5256-4158
Renco	USA:	(516) 586-5566	FAX (516) 586-5562
Sanyo	USA:	(619) 661-6835	FAX (619) 661-1055
	Japan:	(0720) 70-1005	FAX (0720) 70-1174
Sprague	USA:	(603) 224-1961	FAX (603) 224-1430
Sumida	USA:	(708) 956-0666	FAX (708) 956-0702
	Japan:	(81) 3607-5111	FAX (81) 2070-1174
United Chemi-Con	USA:	(714) 255-9500	FAX (714) 255-9400

5V/3.3V/3V/Adjustable-Output, Step-Up/Step-Down DC-DC Converters

Ordering Information (continued)

PART	TEMP. RANGE	PIN-PACKAGE
MAX878 CPA	0°C to +70°C	8 Plastic DIP
MAX878CSA	0°C to +70°C	8 SO
MAX878C/D	0°C to +70°C	Dice*
MAX878EPA	-40°C to +85°C	8 Plastic DIP
MAX878ESA	-40°C to +85°C	8 SO
MAX878MJA	-55°C to +125°C	8 CERDIP
MAX879 CPA	0°C to +70°C	8 Plastic DIP
MAX879CSA	0°C to +70°C	8 SO
MAX879C/D	0°C to +70°C	Dice*
MAX879EPA	-40°C to +85°C	8 Plastic DIP
MAX879ESA	-40°C to +85°C	8 SO
MAX879MJA	-55°C to +125°C	8 CERDIP

* Contact factory for dice specifications.

Chip Topography

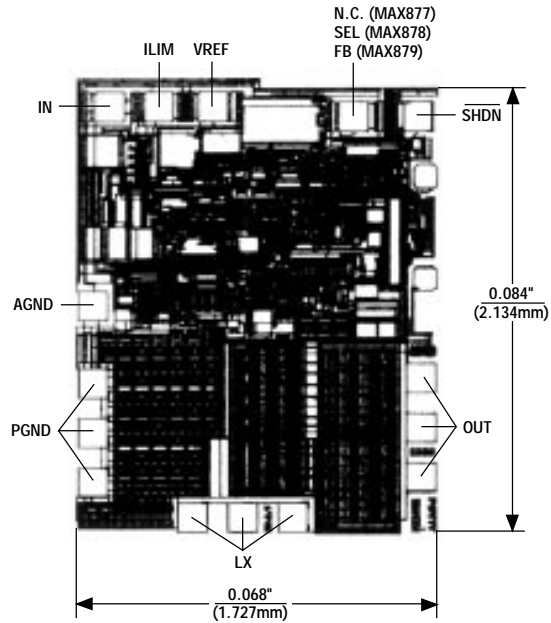

MAX877/MAX878/MAX879

TRANSISTOR COUNT: 170
SUBSTRATE CONNECTED TO AGND

5V/3.3V/3V/Adjustable-Output, Step-Up/Step-Down DC-DC Converters

Package Information

