

High-Speed CMOS Logic Quad Bilateral Switch

Features

- **Wide Analog-Input-Voltage Range** **0V - 10V**
- **Low "ON" Resistance**
 - $V_{CC} = 4.5V$ **25 Ω**
 - $V_{CC} = 9V$ **15 Ω**
- **Fast Switching and Propagation Delay Times**
- **Low "OFF" Leakage Current**
- **Wide Operating Temperature Range** . . . **-55°C to 125°C**
- **HC Types**
 - **2V to 10V Operation**
 - **High Noise Immunity: $N_{IL} = 30\%$, $N_{IH} = 30\%$ of V_{CC} at $V_{CC} = 5V$ and $10V$**
- **HCT Types**
 - **Direct LSTTL Input Logic Compatibility, $V_{IL} = 0.8V$ (Max), $V_{IH} = 2V$ (Min)**
 - **CMOS Input Compatibility, $I_I \leq 1\mu A$ at V_{OL} , V_{OH}**

Description

The 'HC4066 and CD74HCT4066 contain four independent digitally controlled analog switches that use silicon-gate CMOS technology to achieve operating speeds similar to LSTTL with the low power consumption of standard CMOS integrated circuits.

These switches feature the characteristic linear "ON" resistance of the metal-gate CD4066B. Each switch is turned on by a high-level voltage on its control input.

Ordering Information

PART NUMBER	TEMP. RANGE (°C)	PACKAGE
CD54HC4066F3A	-55 to 125	14 Ld CERDIP
CD74HC4066E	-55 to 125	14 Ld PDIP
CD74HC4066M	-55 to 125	14 Ld SOIC
CD74HC4066MT	-55 to 125	14 Ld SOIC
CD74HC4066M96	-55 to 125	14 Ld SOIC
CD74HC4066PW	-55 to 125	14 Ld TSSOP
CD74HC4066PWR	-55 to 125	14 Ld TSSOP
CD74HC4066PWT	-55 to 125	14 Ld TSSOP
CD74HCT4066E	-55 to 125	14 Ld PDIP
CD74HCT4066M	-55 to 125	14 Ld SOIC
CD74HCT4066MT	-55 to 125	14 Ld SOIC
CD74HCT4066M96	-55 to 125	14 Ld SOIC

NOTE: When ordering, use the entire part number. The suffixes 96 and R denote tape and reel. The suffix T denotes a small-quantity reel of 250.

Pinout

CD54HC4066 (CERDIP)
 CD74HC4066 (PDIP, SOIC, TSSOP)
 CD74HCT4066 (PDIP, SOIC)
 TOP VIEW

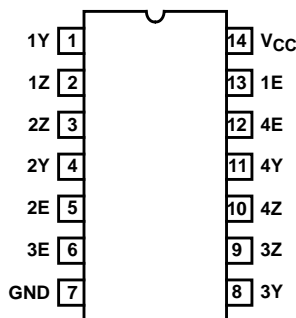

Functional Diagram

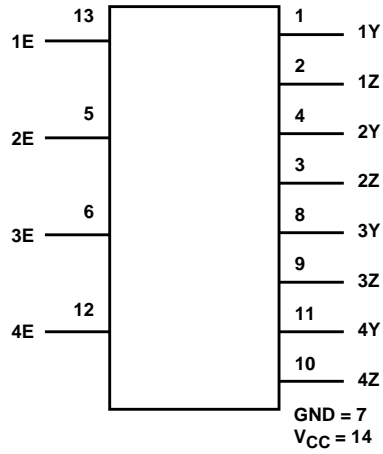

TRUTH TABLE

INPUT nE	SWITCH
L	Off
H	On

H= High Level
 L= Low Level

Logic Diagram

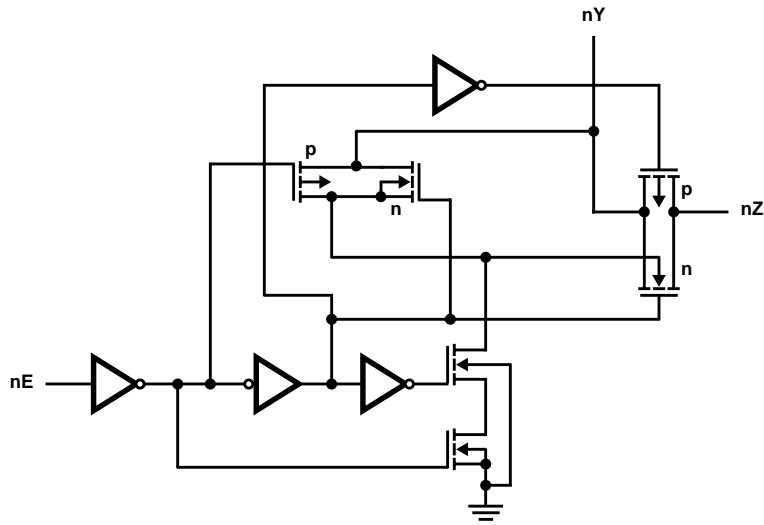

CD54HC4066, CD74HC4066, CD74HCT4066

Absolute Maximum Ratings

DC Supply Voltage, V_{CC}	
HCT Types	-0.5V to 7V
HC Types	-0.5V to 10.5V
DC Input Diode Current, I_{IK}	
For $V_I < -0.5V$ or $V_I > V_{CC} + 0.5V$	±20mA
DC Switch Current, I_O (Note 1)	
For $-0.5V < V_O < V_{CC} + 0.5V$	±25mA
DC Output Diode Current, I_{OK}	
For $V_O < -0.5V$ or $V_O > V_{CC} + 0.5V$	±20mA
DC Output Source or Sink Current per Output Pin, I_O	
For $V_O > -0.5V$ or $V_O < V_{CC} + 0.5V$	±25mA
DC V_{CC} or Ground Current, I_{CC}	±50mA

Thermal Information

Thermal Resistance (Typical, Note 2)	θ_{JA}
E (PDIP) Package	80°C/W
M (SOIC) Package	86°C/W
PW (TSSOP) Package	113°C/W
Maximum Junction Temperature (Hermetic Package or Die)	175°C
Maximum Junction Temperature (Plastic Package)	150°C
Maximum Storage Temperature Range	-65°C to 150°C
Maximum Lead Temperature (Soldering 10s)	300°C
(SOIC - Lead Tips Only)	

Operating Conditions

Temperature Range, T_A	-55°C to 125°C
Supply Voltage Range, V_{CC}	
HC Types	2V to 10V
HCT Types	4.5V to 5.5V
DC Input or Output Voltage, V_I, V_O	0V to V_{CC}
Input Rise and Fall Time	
2V	1000ns (Max)
4.5V	500ns (Max)
6V	400ns (Max)

CAUTION: Stresses above those listed in "Absolute Maximum Ratings" may cause permanent damage to the device. This is a stress only rating and operation of the device at these or any other conditions above those indicated in the operational sections of this specification is not implied.

NOTES:

- In certain applications, the external load-resistor current may include both V_{CC} and signal-line components. To avoid drawing V_{CC} current when switch current flows into the transmission gate inputs, (terminals 1, 4, 8 and 11) the voltage drop across the bidirectional switch must not exceed 0.6V (calculated from R_{ON} values shown in the DC Electrical Specifications Table). No V_{CC} current will flow through R_L if the switch current flows into terminals 2, 3, 9 and 10.
- The package thermal impedance is calculated in accordance with JESD 51-7.

DC Electrical Specifications

PARAMETER	SYMBOL	TEST CONDITIONS		V_{CC} (V)	25°C			-40°C TO 85°C		-55°C TO 125°C		UNITS
		V_I (V)	V_{IS} (V)		MIN	TYP	MAX	MIN	MAX	MIN	MAX	
HC TYPES												
High Level Input Voltage	V_{IH}	-	-	2	1.5	-	-	1.5	-	1.5	-	V
				4.5	3.15	-	-	3.15	-	3.15	-	V
				9	6.3	-	-	6.3	-	6.3	-	V
Low Level Input Voltage	V_{IL}	-	-	2	-	-	0.5	-	0.5	-	0.5	V
				4.5	-	-	1.35	-	1.35	-	1.35	V
				9	-	-	2.7	-	2.7	-	2.7	V
Input Leakage Current (Any Control)	I_{IL}	V_{CC} or GND	-	10	-	-	±0.1	-	±1	-	±1	μA
Off-Switch Leakage Current	I_Z	V_{IL}	V_{CC} or GND	10	-	-	±0.1	-	±1	-	±1	μA

CD54HC4066, CD74HC4066, CD74HCT4066

DC Electrical Specifications (Continued)

PARAMETER	SYMBOL	TEST CONDITIONS		V _{CC} (V)	25°C			-40°C TO 85°C		-55°C TO 125°C		UNITS
		V _I (V)	V _{IS} (V)		MIN	TYP	MAX	MIN	MAX	MIN	MAX	
"ON" Resistance I _O = 1mA (Figure 1)	R _{ON}	V _{CC}	V _{CC} or GND	4.5	-	25	80	-	106	-	128	Ω
				6	-	20	75	-	94	-	113	Ω
				9	-	15	60	-	78	-	95	Ω
		V _{CC} to GND	4.5	-	35	95	-	118	-	142	Ω	
			6	-	24	84	-	105	-	126	Ω	
			9	-	16	70	-	88	-	105	Ω	
"ON" Resistance Between Any Two Switches	ΔR _{ON}	V _{CC}	-	4.5	-	1	-	-	-	-	-	Ω
				6	-	0.75	-	-	-	-	-	Ω
				9	-	0.5	-	-	-	-	-	Ω
Quiescent Device Current	I _{CC}	V _{CC} or GND	-	6	-	-	2	-	20	-	40	μA
				10	-	-	16	-	160	-	320	μA
HCT TYPES												
High Level Input Voltage	V _{IH}	-	-	4.5 to 5.5	2	-	-	2	-	2	-	V
Low Level Input Voltage	V _{IL}	-	-	4.5 to 5.5	-	-	0.8	-	0.8	-	0.8	V
Input Leakage Current (Any Control)	I _{IL}	V _{CC} or GND	-	5.5	-	-	±0.1	-	±1	-	±1	μA
Off-Switch Leakage Current	I _Z	V _{IL}	V _{CC} or GND	5.5	-	-	±0.1	-	±1	-	±1	μA
"ON" Resistance I _O = 1mA (Figure 1)	R _{ON}	V _{CC}	V _{CC} or GND	4.5	-	25	80	-	106	-	128	Ω
			V _{CC} to GND	4.5	-	35	95	-	118	-	142	Ω
"ON" Resistance Between Any Two Switches	ΔR _{ON}	V _{CC}	-	4.5	-	1	-	-	-	-	-	Ω
Quiescent Device Current	I _{CC}	V _{CC} or GND	-	5.5	-	-	2	-	20	-	40	μA
Additional Quiescent Device Current Per Input Pin: 1 Unit Load	ΔI _{CC} (Note 3)	V _{CC} - 2.1	-	4.5 to 5.5	-	100	360	-	450	-	490	μA

NOTE:

- For dual-supply systems theoretical worst case (V_I = 2.4V, V_{CC} = 5.5V) specification is 1.8mA.

HCT Input Loading Table

INPUT	UNIT LOADS
All	1

NOTE: Unit Load is ΔI_{CC} limit specified in DC Electrical Specifications table, e.g., 360μA max at 25°C.

CD54HC4066, CD74HC4066, CD74HCT4066

Switching Specifications Input $t_r, t_f = 6\text{ns}$

PARAMETER	SYMBOL	TEST CONDITIONS	V _{CC} (V)	25°C			-40°C TO 85°C		-55°C TO 125°C		UNITS
				MIN	TYP	MAX	MIN	MAX	MIN	MAX	
HC TYPES											
Propagation Delay Time Switch In to Out	t _{PLH} , t _{PHL}	C _L = 50pF	2	-	-	60	-	75	-	90	ns
			4.5	-	-	12	-	15	-	18	ns
			9	-	-	8	-	11	-	13	ns
		C _L = 15pF	5	-	4	-	-	-	-	-	ns
Propagation Delay Time Switch Turn On Delay	t _{PZH} , t _{PZL}	C _L = 50pF	2	-	-	100	-	125	-	150	ns
			4.5	-	-	20	-	25	-	30	ns
			9	-	-	12	-	15	-	18	ns
		C _L = 15pF	5	-	8	-	-	-	-	-	ns
Propagation Delay Time Switch Turn Off Delay	t _{PHZ} , t _{PLZ}	C _L = 50pF	2	-	-	150	-	190	-	225	ns
			4.5	-	-	30	-	38	-	45	ns
			9	-	-	24	-	30	-	36	ns
		C _L = 15pF	5	-	12	-	-	-	-	-	ns
Input (Control) Capacitance	C _I	-	-	-	10	-	10	-	10	pF	
Power Dissipation Capacitance (Notes 4, 5)	C _{PD}	-	5	-	25	-	-	-	-	pF	
HCT TYPES											
Propagation Delay Time Switch In to Out	t _{PLH} , t _{PHL}	C _L = 50pF	4.5	-	-	12	-	15	-	18	ns
		C _L = 15pF	5	-	4	-	-	-	-	-	ns
Propagation Delay Time Switch Turn On Delay	t _{PZH} , t _{PZL}	C _L = 50pF	4.5	-	-	24	-	30	-	36	ns
		C _L = 15pF	5	-	9	-	-	-	-	-	ns
Propagation Delay Time Switch Turn Off Delay	t _{PHZ} , t _{PLZ}	C _L = 50pF	4.5	-	-	35	-	44	-	53	ns
		C _L = 15pF	5	-	14	-	-	-	-	-	ns
Input (Control) Capacitance	C _I	-	-	-	10	-	10	-	10	pF	
Power Dissipation Capacitance (Notes 4, 5)	C _{PD}	-	5	-	38	-	-	-	-	pF	

NOTES:

- C_{PD} is used to determine the dynamic power consumption, per package.
- $P_D = C_{PD} V_{CC}^2 f_i + \sum (C_L + C_S) V_{CC}^2 f_o$ where f_i = input frequency, f_o = output frequency, C_L = output load capacitance, C_S = switch capacitance, V_{CC} = supply voltage.

Analog Channel Specifications T_A = 25°C

PARAMETER	TEST CONDITIONS	V _{CC} (V)	HC4066	CD74HCT4066	UNITS
Switch Frequency Response Bandwidth at -3dB Figure 2	Figure 5, Notes 6, 7	4.5	200	200	MHz
Cross Talk Between Any Two Switches Figure 3	Figure 4, Notes 7, 8	4.5	-72	-72	dB
Total Harmonic Distortion	Figure 6, 1kHz, V _{IS} = 4V _{P-P}	4.5	0.022	0.023	%
	Figure 6, 1kHz, V _{IS} = 8V _{P-P}	9	0.008	N/A	%

CD54HC4066, CD74HC4066, CD74HCT4066

Analog Channel Specifications $T_A = 25^\circ\text{C}$ (Continued)

PARAMETER	TEST CONDITIONS	V_{CC} (V)	HC4066	CD74HCT4066	UNITS
Control to Switch Feedthrough Noise	Figure 7	4.5	200	130	mV
		9	550	N/A	mV
Switch "OFF" Signal Feedthrough Figure 3	Figure 8, Notes 7, 8	4.5	-72	-72	dB
Switch Input Capacitance, C_S		-	5	5	pF

NOTES:

6. Adjust input level for 0dBm at output, $f = 1\text{MHz}$.
7. V_{IS} is centered at $V_{CC}/2$.
8. Adjust input for 0dBm at V_{IS} .

Typical Performance Curves

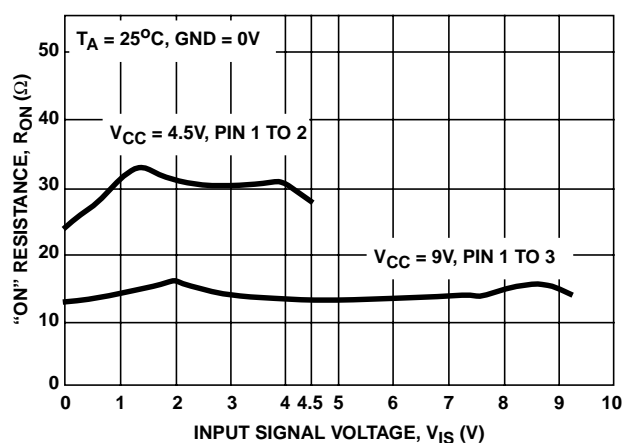

FIGURE 1. TYPICAL "ON" RESISTANCE vs INPUT SIGNAL VOLTAGE

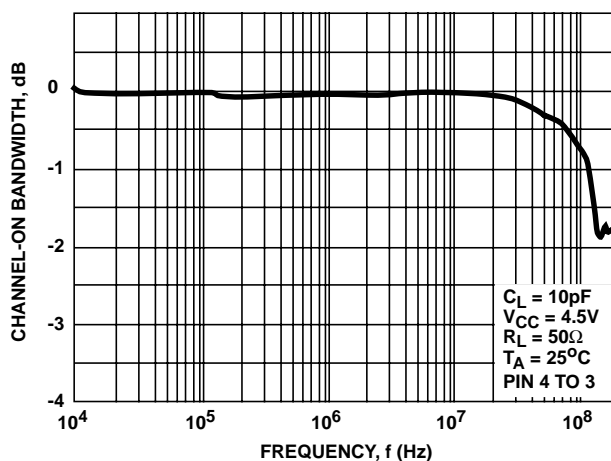

FIGURE 2. SWITCH FREQUENCY RESPONSE, $V_{CC} = 4.5\text{V}$

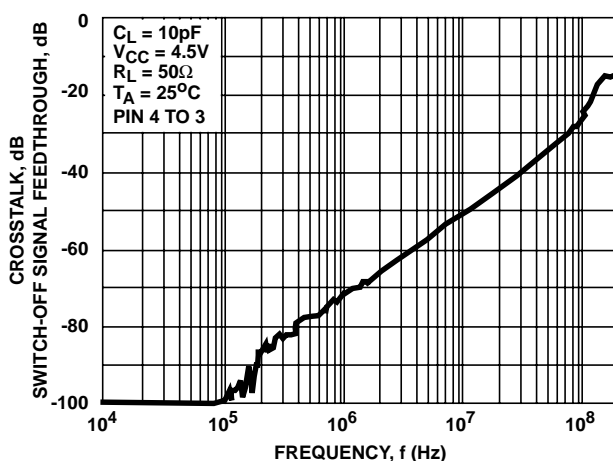

FIGURE 3. SWITCH-OFF SIGNAL FEEDTHROUGH AND CROSSTALK vs FREQUENCY, $V_{CC} = 4.5\text{V}$

Analog Test Circuits

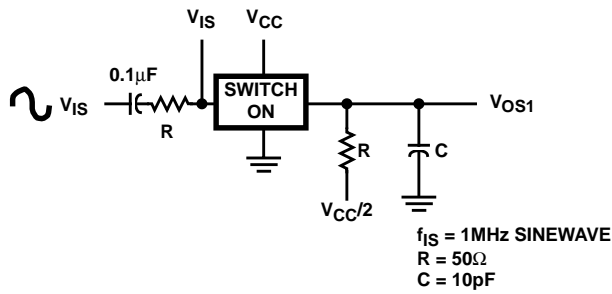

FIGURE 4. CROSTALK BETWEEN TWO SWITCHES TEST CIRCUIT

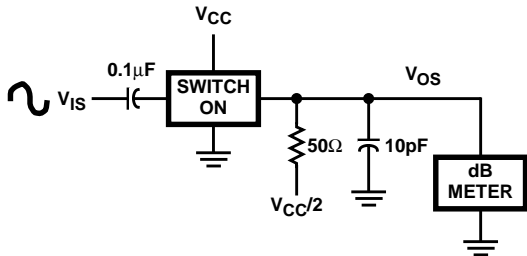
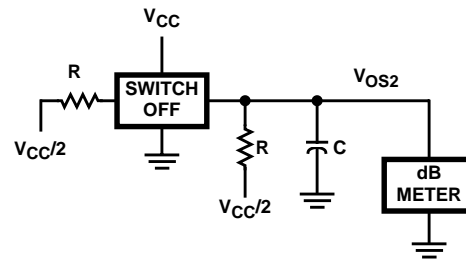

FIGURE 6. TOTAL HARMONIC DISTORTION TEST CIRCUIT

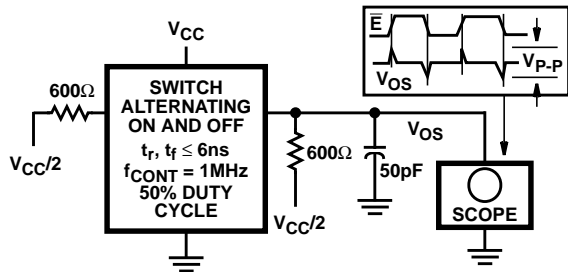

FIGURE 7. CONTROL-TO-SWITCH FEEDTHROUGH NOISE TEST CIRCUIT

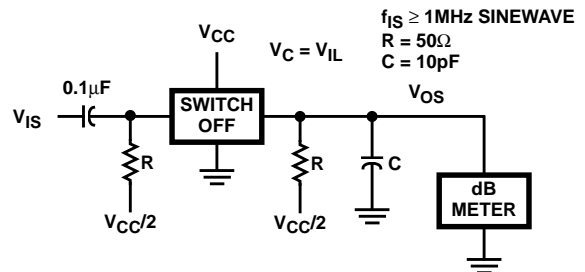

FIGURE 8. SWITCH OFF SIGNAL FEEDTHROUGH

Test Circuits and Waveforms

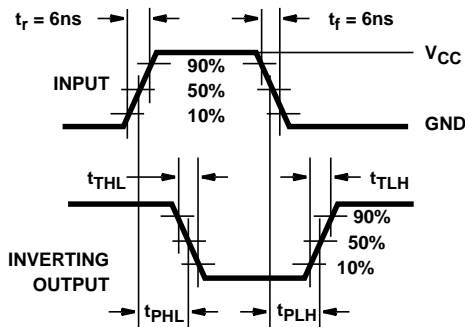

FIGURE 9. HC TRANSITION TIMES AND PROPAGATION DELAY TIMES, COMBINATION LOGIC

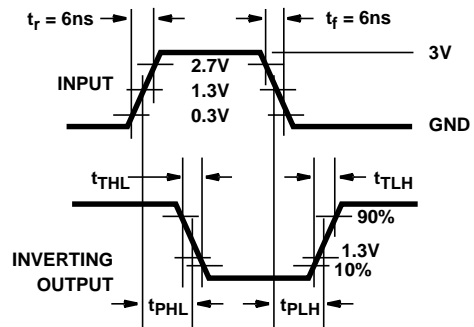

FIGURE 10. HCT TRANSITION TIMES AND PROPAGATION DELAY TIMES, COMBINATION LOGIC

PACKAGING INFORMATION

Orderable Device	Status ⁽¹⁾	Package Type	Package Drawing	Pins	Package Qty	Eco Plan ⁽²⁾	Lead/Ball Finish	MSL Peak Temp ⁽³⁾
5962-8950701CA	ACTIVE	CDIP	J	14	1	None	Call TI	Level-NC-NC-NC
CD54HC4066F3A	ACTIVE	CDIP	J	14	1	None	Call TI	Level-NC-NC-NC
CD74HC4066E	ACTIVE	PDIP	N	14	25	Pb-Free (RoHS)	CU NIPDAU	Level-NC-NC-NC
CD74HC4066M	ACTIVE	SOIC	D	14	50	Pb-Free (RoHS)	CU NIPDAU	Level-2-260C-1 YEAR/ Level-1-235C-UNLIM
CD74HC4066M96	ACTIVE	SOIC	D	14	2500	Pb-Free (RoHS)	CU NIPDAU	Level-2-260C-1 YEAR/ Level-1-235C-UNLIM
CD74HC4066MT	ACTIVE	SOIC	D	14	250	Pb-Free (RoHS)	CU NIPDAU	Level-2-260C-1 YEAR/ Level-1-235C-UNLIM
CD74HC4066PW	ACTIVE	TSSOP	PW	14	90	Pb-Free (RoHS)	CU NIPDAU	Level-1-250C-UNLIM
CD74HC4066PWR	ACTIVE	TSSOP	PW	14	2000	Pb-Free (RoHS)	CU NIPDAU	Level-1-250C-UNLIM
CD74HC4066PWT	ACTIVE	TSSOP	PW	14	250	Pb-Free (RoHS)	CU NIPDAU	Level-1-250C-UNLIM
CD74HCT4066E	ACTIVE	PDIP	N	14	25	Pb-Free (RoHS)	CU NIPDAU	Level-NC-NC-NC
CD74HCT4066M	ACTIVE	SOIC	D	14	50	Pb-Free (RoHS)	CU NIPDAU	Level-2-260C-1 YEAR/ Level-1-235C-UNLIM
CD74HCT4066M96	ACTIVE	SOIC	D	14	2500	Pb-Free (RoHS)	CU NIPDAU	Level-2-260C-1 YEAR/ Level-1-235C-UNLIM
CD74HCT4066MT	ACTIVE	SOIC	D	14	250	Pb-Free (RoHS)	CU NIPDAU	Level-2-260C-1 YEAR/ Level-1-235C-UNLIM

⁽¹⁾ The marketing status values are defined as follows:

ACTIVE: Product device recommended for new designs.

LIFEBUY: TI has announced that the device will be discontinued, and a lifetime-buy period is in effect.

NRND: Not recommended for new designs. Device is in production to support existing customers, but TI does not recommend using this part in a new design.

PREVIEW: Device has been announced but is not in production. Samples may or may not be available.

OBSELETE: TI has discontinued the production of the device.

⁽²⁾ Eco Plan - May not be currently available - please check <http://www.ti.com/productcontent> for the latest availability information and additional product content details.

None: Not yet available Lead (Pb-Free).

Pb-Free (RoHS): TI's terms "Lead-Free" or "Pb-Free" mean semiconductor products that are compatible with the current RoHS requirements for all 6 substances, including the requirement that lead not exceed 0.1% by weight in homogeneous materials. Where designed to be soldered at high temperatures, TI Pb-Free products are suitable for use in specified lead-free processes.

Green (RoHS & no Sb/Br): TI defines "Green" to mean "Pb-Free" and in addition, uses package materials that do not contain halogens, including bromine (Br) or antimony (Sb) above 0.1% of total product weight.

⁽³⁾ MSL, Peak Temp. -- The Moisture Sensitivity Level rating according to the JEDEC industry standard classifications, and peak solder temperature.

Important Information and Disclaimer:The information provided on this page represents TI's knowledge and belief as of the date that it is provided. TI bases its knowledge and belief on information provided by third parties, and makes no representation or warranty as to the accuracy of such information. Efforts are underway to better integrate information from third parties. TI has taken and continues to take reasonable steps to provide representative and accurate information but may not have conducted destructive testing or chemical analysis on incoming materials and chemicals. TI and TI suppliers consider certain information to be proprietary, and thus CAS numbers and other limited information may not be available for release.

In no event shall TI's liability arising out of such information exceed the total purchase price of the TI part(s) at issue in this document sold by TI

to Customer on an annual basis.

J (R-GDIP-T**)

14 LEADS SHOWN

CERAMIC DUAL IN-LINE PACKAGE

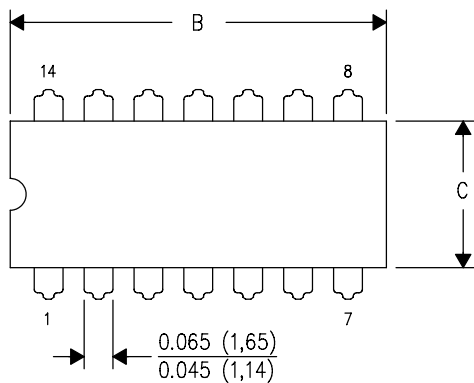

DIM \ PINS **	14	16	18	20
A	0.300 (7,62) BSC	0.300 (7,62) BSC	0.300 (7,62) BSC	0.300 (7,62) BSC
B MAX	0.785 (19,94)	.840 (21,34)	0.960 (24,38)	1.060 (26,92)
B MIN	—	—	—	—
C MAX	0.300 (7,62)	0.300 (7,62)	0.310 (7,87)	0.300 (7,62)
C MIN	0.245 (6,22)	0.245 (6,22)	0.220 (5,59)	0.245 (6,22)



4040083/F 03/03

- NOTES:
- All linear dimensions are in inches (millimeters).
 - This drawing is subject to change without notice.
 - This package is hermetically sealed with a ceramic lid using glass frit.
 - Index point is provided on cap for terminal identification only on press ceramic glass frit seal only.
 - Falls within MIL STD 1835 GDIP1-T14, GDIP1-T16, GDIP1-T18 and GDIP1-T20.

N (R-PDIP-T**)

PLASTIC DUAL-IN-LINE PACKAGE

16 PINS SHOWN



- NOTES:
- A. All linear dimensions are in inches (millimeters).
 - B. This drawing is subject to change without notice.
 - Falls within JEDEC MS-001, except 18 and 20 pin minimum body length (Dim A).
 - The 20 pin end lead shoulder width is a vendor option, either half or full width.

D (R-PDSO-G14)

PLASTIC SMALL-OUTLINE PACKAGE



- NOTES:
- A. All linear dimensions are in inches (millimeters).
 - B. This drawing is subject to change without notice.
 - C. Body dimensions do not include mold flash or protrusion not to exceed 0.006 (0,15).
 - D. Falls within JEDEC MS-012 variation AB.

PW (R-PDSO-G**)

PLASTIC SMALL-OUTLINE PACKAGE

14 PINS SHOWN



4040064/F 01/97

- NOTES: A. All linear dimensions are in millimeters.
 B. This drawing is subject to change without notice.
 C. Body dimensions do not include mold flash or protrusion not to exceed 0,15.
 D. Falls within JEDEC MO-153

IMPORTANT NOTICE

Texas Instruments Incorporated and its subsidiaries (TI) reserve the right to make corrections, modifications, enhancements, improvements, and other changes to its products and services at any time and to discontinue any product or service without notice. Customers should obtain the latest relevant information before placing orders and should verify that such information is current and complete. All products are sold subject to TI's terms and conditions of sale supplied at the time of order acknowledgment.

TI warrants performance of its hardware products to the specifications applicable at the time of sale in accordance with TI's standard warranty. Testing and other quality control techniques are used to the extent TI deems necessary to support this warranty. Except where mandated by government requirements, testing of all parameters of each product is not necessarily performed.

TI assumes no liability for applications assistance or customer product design. Customers are responsible for their products and applications using TI components. To minimize the risks associated with customer products and applications, customers should provide adequate design and operating safeguards.

TI does not warrant or represent that any license, either express or implied, is granted under any TI patent right, copyright, mask work right, or other TI intellectual property right relating to any combination, machine, or process in which TI products or services are used. Information published by TI regarding third-party products or services does not constitute a license from TI to use such products or services or a warranty or endorsement thereof. Use of such information may require a license from a third party under the patents or other intellectual property of the third party, or a license from TI under the patents or other intellectual property of TI.

Reproduction of information in TI data books or data sheets is permissible only if reproduction is without alteration and is accompanied by all associated warranties, conditions, limitations, and notices. Reproduction of this information with alteration is an unfair and deceptive business practice. TI is not responsible or liable for such altered documentation.

Resale of TI products or services with statements different from or beyond the parameters stated by TI for that product or service voids all express and any implied warranties for the associated TI product or service and is an unfair and deceptive business practice. TI is not responsible or liable for any such statements.

Following are URLs where you can obtain information on other Texas Instruments products and application solutions:

Products		Applications	
Amplifiers	amplifier.ti.com	Audio	www.ti.com/audio
Data Converters	dataconverter.ti.com	Automotive	www.ti.com/automotive
DSP	dsp.ti.com	Broadband	www.ti.com/broadband
Interface	interface.ti.com	Digital Control	www.ti.com/digitalcontrol
Logic	logic.ti.com	Military	www.ti.com/military
Power Mgmt	power.ti.com	Optical Networking	www.ti.com/opticalnetwork
Microcontrollers	microcontroller.ti.com	Security	www.ti.com/security
		Telephony	www.ti.com/telephony
		Video & Imaging	www.ti.com/video
		Wireless	www.ti.com/wireless

Mailing Address: Texas Instruments
Post Office Box 655303 Dallas, Texas 75265