

TLE2027, TLE2037, TLE2027A, TLE2037A, TLE2027Y, TLE2037Y EXCALIBUR LOW-NOISE HIGH-SPEED PRECISION OPERATIONAL AMPLIFIERS

SLOS192A – FEBRUARY 1997 REVISED MARCH 2002

- **Outstanding Combination of dc Precision and AC Performance:**

Unity-Gain Bandwidth . . . 15 MHz Typ
 V_n **3.3 nV/ $\sqrt{\text{Hz}}$ at $f = 10$ Hz Typ,**
 2.5 nV/ $\sqrt{\text{Hz}}$ at $f = 1$ kHz Typ
 V_{IO} **25 μV Max**
 A_{VD} . . . **45 V/ μV Typ With $R_L = 2$ k Ω ,**
 19 V/ μV Typ With $R_L = 600$ Ω

- **Available in Standard-Pinout Small-Outline Package**
- **Output Features Saturation Recovery Circuitry**
- **Macromodels and Statistical information**

description

The TLE20x7 and TLE20x7A contain innovative circuit design expertise and high-quality process control techniques to produce a level of ac performance and dc precision previously unavailable in single operational amplifiers. Manufactured using Texas Instruments state-of-the-art Excalibur process, these devices allow upgrades to systems that use lower-precision devices.

In the area of dc precision, the TLE20x7 and TLE20x7A offer maximum offset voltages of 100 μV and 25 μV , respectively, common-mode rejection ratio of 131 dB (typ), supply voltage rejection ratio of 144 dB (typ), and dc gain of 45 V/ μV (typ).

**D, JG, OR P PACKAGE
(TOP VIEW)**

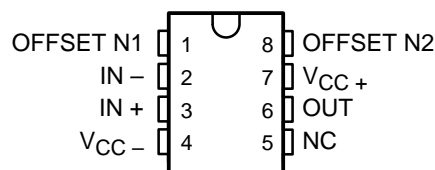

**FK PACKAGE
(TOP VIEW)**

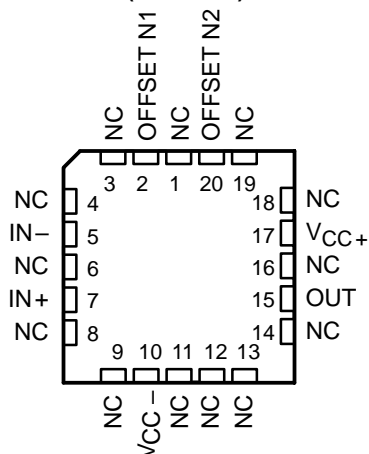

AVAILABLE OPTIONS

T_A	V_{IOmax} AT 25°C	PACKAGED DEVICES				CHIP FORM‡ (Y)
		SMALL OUTLINE† (D)	CHIP CARRIER (FK)	CERAMIC DIP (JG)	PLASTIC DIP (P)	
0°C to 70°C	25 μV	TLE2027ACD TLE2037ACD	—	—	TLE2027ACP TLE2037ACP	TLE2027Y TLE2037Y
	100 μV	TLE2027CD TLE2037CD	—	—	TLE2027CP TLE2037CP	TLE2027Y TLE2037Y
-40°C to 105°C	25 μV	TLE2027AID TLE2037AID	—	—	TLE2027AIP TLE2037AIP	—
	100 μV	TLE2027ID TLE2037ID	—	—	TLE2027IP TLE2037IP	—
-55°C to 125°C	25 μV	TLE2027AMD TLE2037AMD	TLE2027AMFK TLE2037AMFK	TLE2027AMJG TLE2037AMJG	TLE2027AMP TLE2037AMP	—
	100 μV	TLE2027MD TLE2037MD	TLE2027MFK TLE2037MFK	TLE2027MJG TLE2037MJG	TLE2027MP TLE2037MP	—

† The D packages are available taped and reeled. Add R suffix to device type (e.g., TLE2027ACDR).

‡ Chip forms are tested at 25°C only.



Please be aware that an important notice concerning availability, standard warranty, and use in critical applications of Texas Instruments semiconductor products and disclaimers thereto appears at the end of this data sheet.

PRODUCTION DATA information is current as of publication date. Products conform to specifications per the terms of Texas Instruments standard warranty. Production processing does not necessarily include testing of all parameters.



POST OFFICE BOX 655303 • DALLAS, TEXAS 75265

Copyright © 2002, Texas Instruments Incorporated

TLE2027, TLE2037, TLE2027A, TLE2037A, TLE2027Y, TLE2037Y EXCALIBUR LOW-NOISE HIGH-SPEED PRECISION OPERATIONAL AMPLIFIERS

SLOS192A – FEBRUARY 1997 REVISED MARCH 2002

description (continued)

The ac performance of the TLE2027 and TLE2037 is highlighted by a typical unity-gain bandwidth specification of 15 MHz, 55° of phase margin, and noise voltage specifications of 3.3 nV/ $\sqrt{\text{Hz}}$ and 2.5 nV/ $\sqrt{\text{Hz}}$ at frequencies of 10 Hz and 1 kHz respectively. The TLE2037 and TLE2037A have been decompensated for faster slew rate ($-7.5 \text{ V}/\mu\text{s}$, typical) and wider bandwidth (50 MHz). To ensure stability, the TLE2037 and TLE2037A should be operated with a closed-loop gain of 5 or greater.

Both the TLE20x7 and TLE20x7A are available in a wide variety of packages, including the industry-standard 8-pin small-outline version for high-density system applications. The C-suffix devices are characterized for operation from 0°C to 70°C. The I-suffix devices are characterized for operation from -40°C to 105°C. The M-suffix devices are characterized for operation over the full military temperature range of -55°C to 125°C.

symbol

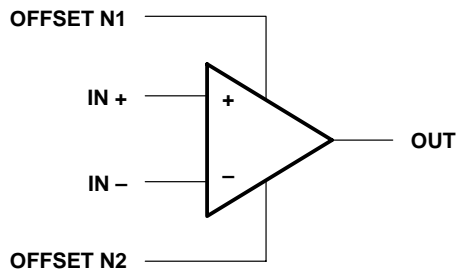

TLE2027, TLE2037, TLE2027A, TLE2037A, TLE2027Y, TLE2037Y
**EXCALIBUR LOW-NOISE HIGH-SPEED
 PRECISION OPERATIONAL AMPLIFIERS**

SLOS192A – FEBRUARY 1997 REVISED MARCH 2002

TLE202xY chip information

This chip, when properly assembled, displays characteristics similar to the TLE202xC. Thermal compression or ultrasonic bonding may be used on the doped-aluminum bonding pads. The chip may be mounted with conductive epoxy or a gold-silicon preform.

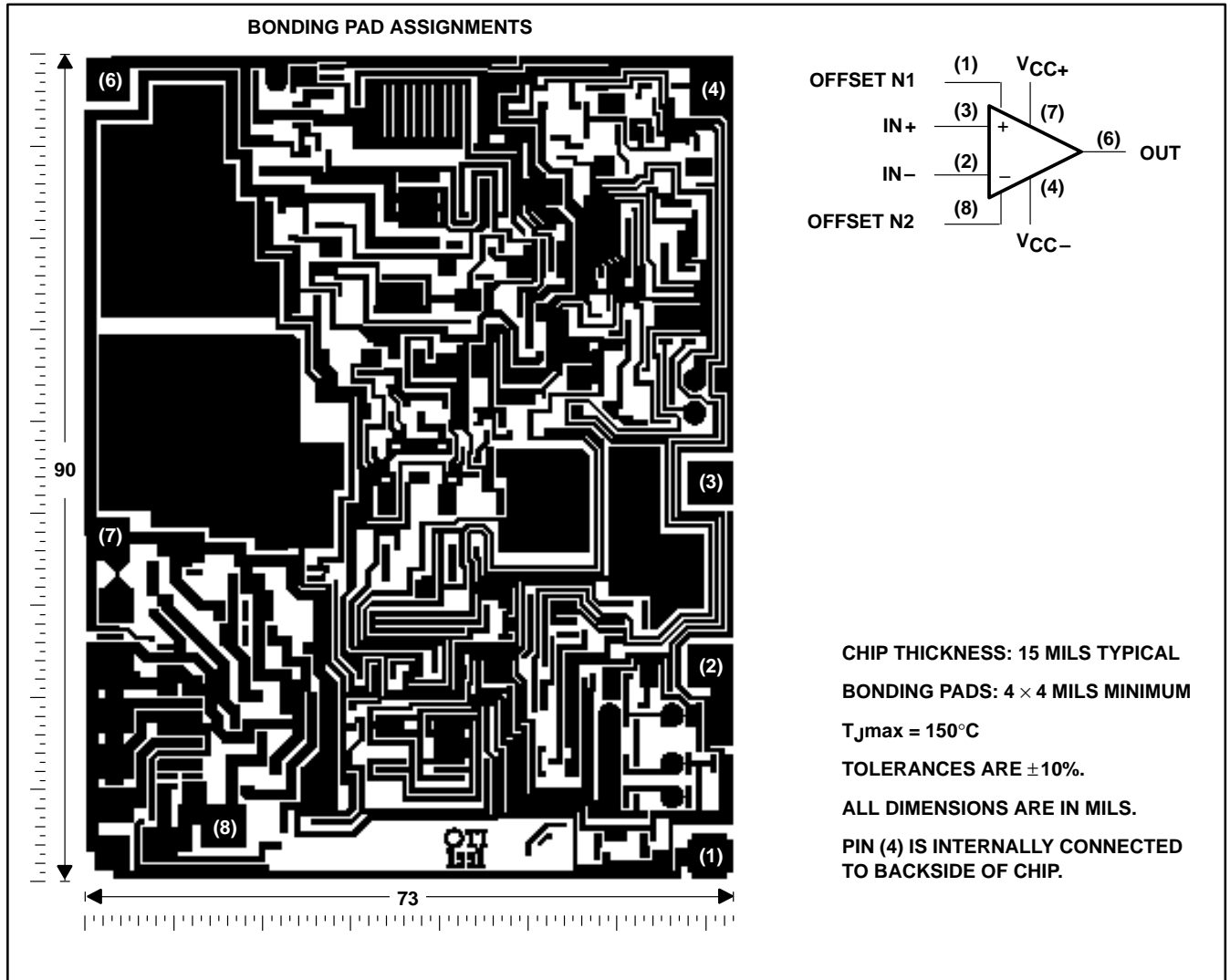

TLE2027, TLE2037, TLE2027A, TLE2037A, TLE2027Y, TLE2037Y
EXCALIBUR LOW-NOISE HIGH-SPEED
PRECISION OPERATIONAL AMPLIFIERS
 SLOS192A - FEBRUARY 1997 REVISED MARCH 2002

equivalent schematic

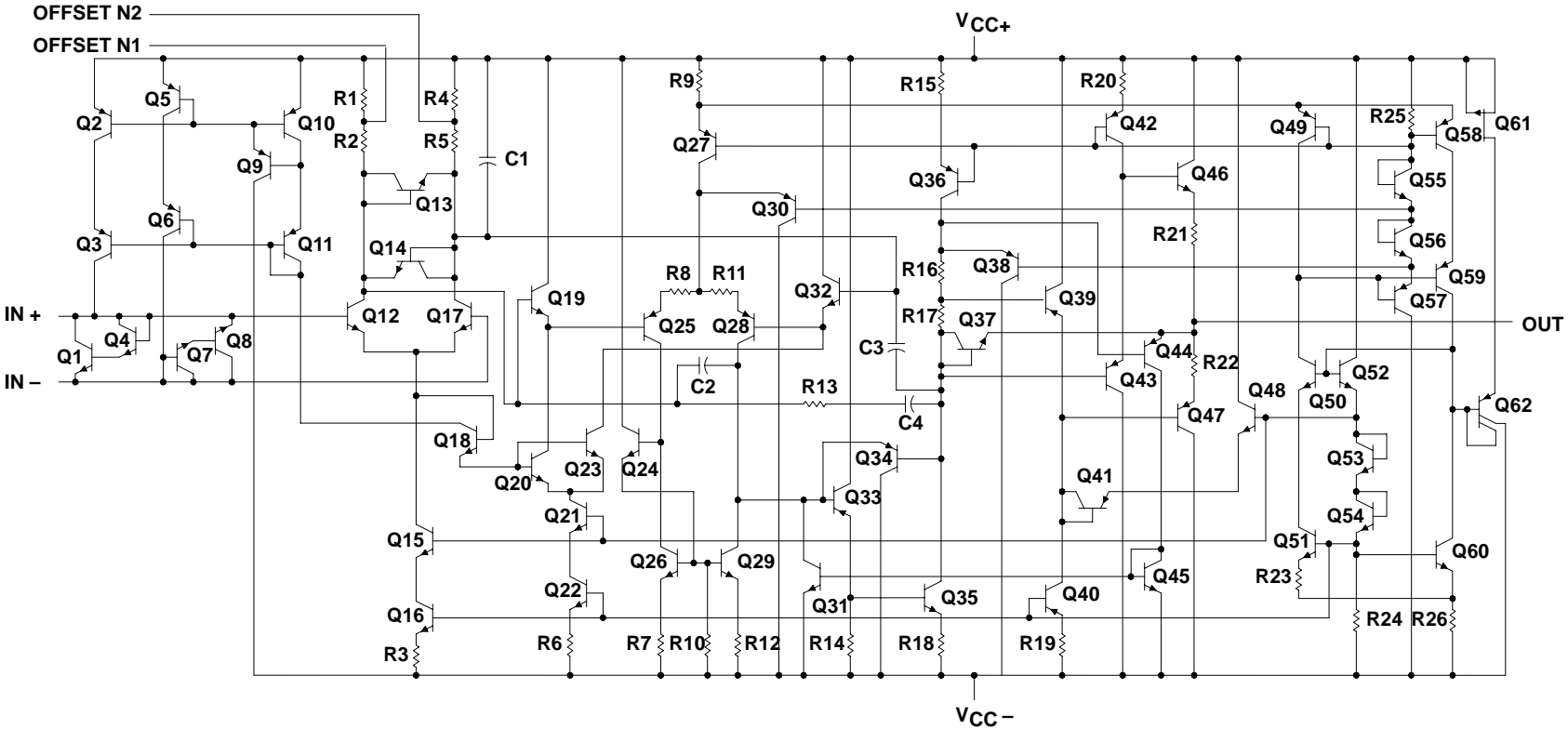

ACTUAL DEVICE COMPONENT COUNT		
COMPONENT	TLE2027	TLE2037
Transistors	61	61
Resistors	26	26
epiFET	1	1
Capacitors	4	4

TLE2027, TLE2037, TLE2027A, TLE2037A, TLE2027Y, TLE2037Y EXCALIBUR LOW-NOISE HIGH-SPEED PRECISION OPERATIONAL AMPLIFIERS

SLOS192A – FEBRUARY 1997 REVISED MARCH 2002

absolute maximum ratings over operating free-air temperature range (unless otherwise noted)†

Supply voltage, V_{CC+} (see Note 1)	19 V
Supply voltage, V_{CC-}	-19 V
Differential input voltage, V_{ID} (see Note 2)	± 1.2 V
Input voltage range, V_I (any input)	$V_{CC\pm}$
Input current, I_I (each Input)	± 1 mA
Output current, I_O	± 50 mA
Total current into V_{CC+}	50 mA
Total current out of V_{CC-}	50 mA
Duration of short-circuit current at (or below) 25°C (see Note 3)	unlimited
Continuous total power dissipation	See Dissipation Rating Table
Operating free-air temperature range, T_A : C suffix	0°C to 70°C
I suffix	-40°C to 105°C
M suffix	-55°C to 125°C
Storage temperature range, T_{stg}	-65°C to 150°C
Case temperature for 60 seconds, T_C : FK package	260°C
Lead temperature 1,6 mm (1/16 inch) from case for 10 seconds: D or P package	260°C
Lead temperature 1,6 mm (1/16 inch) from case for 60 seconds: JG package	300°C

† Stresses beyond those listed under “absolute maximum ratings” may cause permanent damage to the device. These are stress ratings only, and functional operation of the device at these or any other conditions beyond those indicated under “recommended operating conditions” is not implied. Exposure to absolute-maximum-rated conditions for extended periods may affect device reliability.

- NOTES:
- All voltage values, except differential voltages, are with respect to the midpoint between V_{CC+} and V_{CC-} .
 - Differential voltages are at $IN+$ with respect to $IN-$. Excessive current flows if a differential input voltage in excess of approximately ± 1.2 V is applied between the inputs unless some limiting resistance is used.
 - The output may be shorted to either supply. Temperature and/or supply voltages must be limited to ensure that the maximum dissipation rating is not exceeded.

DISSIPATION RATING TABLE

PACKAGE	$T_A \leq 25^\circ\text{C}$	DERATING FACTOR ABOVE $T_A = 25^\circ\text{C}$	$T_A = 70^\circ\text{C}$	$T_A = 105^\circ\text{C}$	$T_A = 125^\circ\text{C}$
	POWER RATING		POWER RATING	POWER RATING	POWER RATING
D	725 mW	5.8 mW/°C	464 mW	261 mW	145 mW
FK	1375 mW	11.0 mW/°C	880 mW	495 mW	275 mW
JG	1050 mW	8.4 mW/°C	672 mW	378 mW	210 mW
P	1000 mW	8.0 mW/°C	640 mW	360 mW	200 mW

recommended operating conditions

		C SUFFIX		I SUFFIX		M SUFFIX		UNIT
		MIN	MAX	MIN	MAX	MIN	MAX	
Supply voltage, $V_{CC\pm}$		± 4	± 19	± 4	± 19	± 4	± 19	V
Common-mode input voltage, V_{IC}	$T_A = 25^\circ\text{C}$	-11	11	-11	11	-11	11	V
	$T_A = \text{Full range}^\ddagger$	-10.5	10.5	-10.4	10.4	-10.2	10.2	
Operating free-air temperature, T_A		0	70	-40	105	-55	125	°C

‡ Full range is 0°C to 70°C for C-suffix devices, -40°C to 105°C for I-suffix devices, and -55°C to 125°C for M-suffix devices.



TLE2027, TLE2037, TLE2027A, TLE2037A, TLE2027Y, TLE2037Y EXCALIBUR LOW-NOISE HIGH-SPEED PRECISION OPERATIONAL AMPLIFIERS

SLOS192A – FEBRUARY 1997 REVISED MARCH 2002

TLE20x7C electrical characteristics at specified free-air temperature, $V_{CC\pm} = \pm 15\text{ V}$ (unless otherwise noted)

PARAMETER	TEST CONDITIONS	T_A †	TLE20x7C			TLE20x7AC			UNIT
			MIN	TYP	MAX	MIN	TYP	MAX	
V_{IO} Input offset voltage	$V_{IC} = 0, R_S = 50\ \Omega$	25°C	20	100		10	25	μV	
		Full range		145		70			
α_{VIO} Temperature coefficient of input offset voltage		Full range	0.4	1		0.2	1	$\mu\text{V}/^\circ\text{C}$	
Input offset voltage long-term drift (see Note 4)		25°C	0.006	1		0.006	1	$\mu\text{V}/\text{mo}$	
I_{IO} Input offset current		25°C	6	90		6	90	nA	
		Full range		150		150			
I_{IB} Input bias current	25°C	15	90		15	90	nA		
	Full range		150		150				
V_{ICR} Common-mode input voltage range	$R_S = 50\ \Omega$	25°C	-11 to 11	-13 to 13		-11 to 11	-13 to 13	V	
		Full range	-10.5 to 10.5			-10.5 to 10.5			
V_{OM+} Maximum positive peak output voltage swing	$R_L = 600\ \Omega$	25°C	10.5	12.9		10.5	12.9	V	
		Full range	10			10			
	$R_L = 2\ \text{k}\Omega$	25°C	12	13.2		12	13.2		
		Full range	11			11			
V_{OM-} Maximum negative peak output voltage swing	$R_L = 600\ \Omega$	25°C	-10.5	-13		-10.5	-13	V	
		Full range	-10			-10			
	$R_L = 2\ \text{k}\Omega$	25°C	-12	-13.5		-12	-13.5		
		Full range	-11			-11			
A_{VD} Large-signal differential voltage amplification	$V_O = \pm 11\ \text{V}, R_L = 2\ \text{k}\Omega$	25°C	5	45		10	45	$\text{V}/\mu\text{V}$	
		Full range	2			4			
	$V_O = \pm 10\ \text{V}, R_L = 2\ \text{k}\Omega$	25°C	3.5	38		8	38		
		Full range	1			2.5			
	$V_O = \pm 10\ \text{V}, R_L = 600\ \Omega$	25°C	2	19		5	19		
		Full range	0.5			2			
C_i Input capacitance		25°C	8		8		pF		
z_o Open-loop output impedance	$I_O = 0$	25°C	50		50		Ω		
CMRR Common-mode rejection ratio	$V_{IC} = V_{ICR\text{min}}, R_S = 50\ \Omega$	25°C	100	131		117	131	dB	
		Full range	98			114			
k_{SVR} Supply-voltage rejection ratio ($\Delta V_{CC\pm} / \Delta V_{IO}$)	$V_{CC\pm} = \pm 4\ \text{V to } \pm 18\ \text{V}, R_S = 50\ \Omega$	25°C	94	144		110	144	dB	
		Full range	92			106			
I_{CC} Supply current	$V_O = 0, \text{ No load}$	25°C	3.8	5.3		3.8	5.3	mA	
		Full range		5.6			5.6		

† Full range is 0°C to 70°C.

NOTE 4: Typical values are based on the input offset voltage shift observed through 168 hours of operating life test at $T_A = 150^\circ\text{C}$ extrapolated to $T_A = 25^\circ\text{C}$ using the Arrhenius equation and assuming an activation energy of 0.96 eV.



TLE2027, TLE2037, TLE2027A, TLE2037A, TLE2027Y, TLE2037Y
EXCALIBUR LOW-NOISE HIGH-SPEED
PRECISION OPERATIONAL AMPLIFIERS

SLOS192A – FEBRUARY 1997 REVISED MARCH 2002

TLE20x7C operating characteristics at specified free-air temperature, $V_{CC} \pm = \pm 15\text{ V}$, $T_A = 25^\circ\text{C}$ (unless otherwise specified)

PARAMETER	TEST CONDITIONS		TLE20x7C			TLE20x7AC			UNIT
			MIN	TYP	MAX	MIN	TYP	MAX	
SR Slew rate at unity gain	$R_L = 2\text{ k}\Omega$, $C_L = 100\text{ pF}$, See Figure 1	TLE2027	1.7	2.8		1.7	2.8	V/ μ s	
		TLE2037	6	7.5		6	7.5		
	$R_L = 2\text{ k}\Omega$, $C_L = 100\text{ pF}$, $T_A = 0^\circ\text{C to } 70^\circ\text{C}$, See Figure 1	TLE2027	1.2			1.2			
		TLE2037	5			5			
V_n Equivalent input noise voltage (see Figure 2)	$R_S = 20\ \Omega$, $f = 10\text{ Hz}$			3.3	8		3.3	4.5	nV/ $\sqrt{\text{Hz}}$
	$R_S = 20\ \Omega$, $f = 1\text{ kHz}$			2.5	4.5		2.5	3.8	
$V_N(\text{PP})$ Peak-to-peak equivalent input noise voltage	$f = 0.1\text{ Hz to } 10\text{ Hz}$			50	250		50	130	nV
I_n Equivalent input noise current	$f = 10\text{ Hz}$			10	25		10	25	pA/ $\sqrt{\text{Hz}}$
	$f = 1\text{ kHz}$			0.8	1.8		0.8	1.8	
THD Total harmonic distortion	$V_O = +10\text{ V}$, $A_{VD} = 1$, See Note 5	TLE2027	<0.002%			<0.002%			
	$V_O = +10\text{ V}$, $A_{VD} = 5$, See Note 5	TLE2037	<0.002%			<0.002%			
B_1 Unity-gain bandwidth (see Figure 3)	$R_L = 2\text{ k}\Omega$, $C_L = 100\text{ pF}$	TLE2027	7	13		9	13	MHz	
		TLE2037	35	50		35	50		
B_{OM} Maximum output-swing bandwidth	$R_L = 2\text{ k}\Omega$	TLE2027	30			30			kHz
		TLE2037	80			80			
ϕ_m Phase margin at unity gain (see Figure 3)	$R_L = 2\text{ k}\Omega$, $C_L = 100\text{ pF}$	TLE2027	55°			55°			
		TLE2037	50°			50°			

NOTE 5: Measured distortion of the source used in the analysis was 0.002%.

TLE2027, TLE2037, TLE2027A, TLE2037A, TLE2027Y, TLE2037Y EXCALIBUR LOW-NOISE HIGH-SPEED PRECISION OPERATIONAL AMPLIFIERS

SLOS192A – FEBRUARY 1997 REVISED MARCH 2002

TLE20x7I electrical characteristics at specified free-air temperature, $V_{CC\pm} = \pm 15\text{ V}$ (unless otherwise noted)

PARAMETER	TEST CONDITIONS	T_A †	TLE20x7I			TLE20x7AI			UNIT
			MIN	TYP	MAX	MIN	TYP	MAX	
V_{IO} Input offset voltage	$V_{IC} = 0, R_S = 50\ \Omega$	25°C	20	100		10	25	μV	
		Full range			180		105		
α_{VIO} Temperature coefficient of input offset voltage		Full range	0.4	1		0.2	1	$\mu\text{V}/^\circ\text{C}$	
Input offset voltage long-term drift (see Note 4)		25°C	0.006	1		0.006	1	$\mu\text{V}/\text{mo}$	
I_{IO} Input offset current		25°C	6	90		6	90	nA	
		Full range			150		150		
I_{IB} Input bias current	25°C	15	90		15	90	nA		
	Full range			150		150			
V_{ICR} Common-mode input voltage range	$R_S = 50\ \Omega$	25°C	-11 to 11	-13 to 13		-11 to 11	-13 to 13	V	
		Full range	-10.4 to 10.4			-10.4 to 10.4			
V_{OM+} Maximum positive peak output voltage swing	$R_L = 600\ \Omega$	25°C	10.5	12.9		10.5	12.9	V	
		Full range	10			10			
	$R_L = 2\ \text{k}\Omega$	25°C	12	13.2		12	13.2		
		Full range	11			11			
V_{OM-} Maximum negative peak output voltage swing	$R_L = 600\ \Omega$	25°C	-10.5	-13		-10.5	-13	V	
		Full range	-10			-10			
	$R_L = 2\ \text{k}\Omega$	25°C	-12	-13.5		-12	-13.5		
		Full range	-11			-11			
A_{VD} Large-signal differential voltage amplification	$V_O = \pm 11\ \text{V}, R_L = 2\ \text{k}\Omega$	25°C	5	45		10	45	$\text{V}/\mu\text{V}$	
	$V_O = \pm 10\ \text{V}, R_L = 2\ \text{k}\Omega$	Full range	2			3.5			
	$V_O = \pm 10\ \text{V}, R_L = 1\ \text{k}\Omega$	25°C	3.5	38		8	38		
		Full range	1			2.2			
	$V_O = \pm 10\ \text{V}, R_L = 600\ \Omega$	25°C	2	19		5	19		
		Full range	0.5			1.1			
C_i Input capacitance		25°C		8		8	pF		
z_o Open-loop output impedance	$I_O = 0$	25°C		50		50	Ω		
CMRR Common-mode rejection ratio	$V_{IC} = V_{ICRmin}, R_S = 50\ \Omega$	25°C	100	131		117	131	dB	
		Full range	96			113			
k_{SVR} Supply-voltage rejection ratio ($\Delta V_{CC\pm} / \Delta V_{IO}$)	$V_{CC\pm} = \pm 4\ \text{V to } \pm 18\ \text{V}, R_S = 50\ \Omega$	25°C	94	144		110	144	dB	
	$V_{CC\pm} = \pm 4\ \text{V to } \pm 18\ \text{V}, R_S = 50\ \Omega$	Full range	90			105			
I_{CC} Supply current	$V_O = 0, \text{ No load}$	25°C	3.8	5.3		3.8	5.3	mA	
		Full range			5.6		5.6		

† Full range is -40°C to 105°C .

NOTE 4: Typical values are based on the input offset voltage shift observed through 168 hours of operating life test at $T_A = 150^\circ\text{C}$ extrapolated to $T_A = 25^\circ\text{C}$ using the Arrhenius equation and assuming an activation energy of 0.96 eV.



TLE2027, TLE2037, TLE2027A, TLE2037A, TLE2027Y, TLE2037Y
EXCALIBUR LOW-NOISE HIGH-SPEED
PRECISION OPERATIONAL AMPLIFIERS

SLOS192A – FEBRUARY 1997 REVISED MARCH 2002

TLE20x7I operating characteristics at specified free-air temperature, $V_{CC \pm} = \pm 15\text{ V}$, $T_A = 25^\circ\text{C}$ (unless otherwise specified)

PARAMETER	TEST CONDITIONS		TLE20x7I			TLE20x7AI			UNIT	
			MIN	TYP	MAX	MIN	TYP	MAX		
SR	Slew rate at unity gain	$R_L = 2\text{ k}\Omega$, $C_L = 100\text{ pF}$, See Figure 1	TLE2027	1.7	2.8		1.7	2.8	V/ μs	
			TLE2037	6	7.5		6	7.5		
	$R_L = 2\text{ k}\Omega$, $C_L = 100\text{ pF}$, $T_A = -40^\circ\text{C}$ to 85°C , See Figure 1	TLE2027	1.1			1.1				
		TLE2037	4.7			4.7				
V_n	Equivalent input noise voltage (see Figure 2)	$R_S = 20\ \Omega$, $f = 10\text{ Hz}$		3.3	8		3.3	4.5	nV/ $\sqrt{\text{Hz}}$	
			$R_S = 20\ \Omega$, $f = 1\text{ kHz}$		2.5	4.5		2.5		3.8
$V_{N(PP)}$	Peak-to-peak equivalent input noise voltage	$f = 0.1\text{ Hz}$ to 10 Hz			50	250		50	130	nV
I_n	Equivalent input noise current	$f = 10\text{ Hz}$			10	25		10	25	pA/ $\sqrt{\text{Hz}}$
		$f = 1\text{ kHz}$			0.8	1.8		0.8	1.8	
THD	Total harmonic distortion	$V_O = +10\text{ V}$, $A_{VD} = 1$, See Note 5	TLE2027	< 0.002%		< 0.002%		< 0.002%		
		$V_O = +10\text{ V}$, $A_{VD} = 5$, See Note 5	TLE2037	< 0.002%		< 0.002%		< 0.002%		
B_1	Unity-gain bandwidth (see Figure 3)	$R_L = 2\text{ k}\Omega$, $C_L = 100\text{ pF}$	TLE2027	7	13		9	13	MHz	
			TLE2037	35	50		35	50		
B_{OM}	Maximum output-swing bandwidth	$R_L = 2\text{ k}\Omega$	TLE2027	30		30		30		kHz
			TLE2037	80		80		80		
ϕ_m	Phase margin at unity gain (see Figure 3)	$R_L = 2\text{ k}\Omega$, $C_L = 100\text{ pF}$	TLE2027	55°		55°		55°		
			TLE2037	50°		50°		50°		

NOTE 5: Measured distortion of the source used in the analysis was 0.002%.

TLE2027, TLE2037, TLE2027A, TLE2037A, TLE2027Y, TLE2037Y
EXCALIBUR LOW-NOISE HIGH-SPEED
PRECISION OPERATIONAL AMPLIFIERS

SLOS192A – FEBRUARY 1997 REVISED MARCH 2002

TLE20x7M electrical characteristics at specified free-air temperature, $V_{CC\pm} = \pm 15\text{ V}$ (unless otherwise noted)

PARAMETER	TEST CONDITIONS	T_A †	TLE20x7M			TLE20x7AM			UNIT
			MIN	TYP	MAX	MIN	TYP	MAX	
V_{IO} Input offset voltage	$V_{IC} = 0, R_S = 50\ \Omega$	25°C	20	100		10	25	μV	
		Full range			200		105		
α_{VIO} Temperature coefficient of input offset voltage		Full range	0.4	1*		0.2	1*	$\mu\text{V}/^\circ\text{C}$	
Input offset voltage long-term drift (see Note 4)		25°C	0.006	1*		0.006	1*	$\mu\text{V}/\text{mo}$	
I_{IO} Input offset current		25°C	6	90		6	90	nA	
		Full range			150		150		
I_{IB} Input bias current	25°C	15	90		15	90	nA		
	Full range			150		150			
V_{ICR} Common-mode input voltage range	$R_S = 50\ \Omega$	25°C	-11 to 11	-13 to 13		-11 to 11	-13 to 13	V	
		Full range	-10.3 to 10.3			-10.4 to 10.4			
V_{OM+} Maximum positive peak output voltage swing	$R_L = 600\ \Omega$	25°C	10.5	12.9		10.5	12.9	V	
		Full range	10			10			
	$R_L = 2\ \text{k}\Omega$	25°C	12	13.2		12	13.2		
		Full range	11			11			
V_{OM-} Maximum negative peak output voltage swing	$R_L = 600\ \Omega$	25°C	-10.5	-13		-10.5	-13	V	
		Full range	-10			-10			
	$R_L = 2\ \text{k}\Omega$	25°C	-12	-13.5		-12	-13.5		
		Full range	-11			-11			
A_{VD} Large-signal differential voltage amplification	$V_O = \pm 11\ \text{V}, R_L = 2\ \text{k}\Omega$	25°C	5	45		10	45	$\text{V}/\mu\text{V}$	
	$V_O = \pm 10\ \text{V}, R_L = 2\ \text{k}\Omega$	Full range	2.5			3.5			
	$V_O = \pm 10\ \text{V}, R_L = 1\ \text{k}\Omega$	25°C	3.5	38		8	38		
		Full range	1.8			2.2			
	$V_O = \pm 10\ \text{V}, R_L = 600\ \Omega$	25°C	2	19		5	19		
C_i Input capacitance		25°C	8			8	pF		
Z_o Open-loop output impedance	$I_O = 0$	25°C	50			50	Ω		
CMRR Common-mode rejection ratio	$V_{IC} = V_{ICRmin}, R_S = 50\ \Omega$	25°C	100	131		117	131	dB	
		Full range	96			113			
k_{SVR} Supply-voltage rejection ratio ($\Delta V_{CC\pm} / \Delta V_{IO}$)	$V_{CC\pm} = \pm 4\ \text{V to } \pm 18\ \text{V}, R_S = 50\ \Omega$	25°C	94	144		110	144	dB	
	$V_{CC\pm} = \pm 4\ \text{V to } \pm 18\ \text{V}, R_S = 50\ \Omega$	Full range	90			105			
I_{CC} Supply current	$V_O = 0, \text{ No load}$	25°C	3.8	5.3		3.8	5.3	mA	
		Full range			5.6		5.6		

* On products compliant to MIL-PRF-38535, this parameter is not production tested.

† Full range is -55°C to 125°C.

NOTE 4: Typical values are based on the input offset voltage shift observed through 168 hours of operating life test at $T_A = 150^\circ\text{C}$ extrapolated to $T_A = 25^\circ\text{C}$ using the Arrhenius equation and assuming an activation energy of 0.96 eV.



TLE2027, TLE2037, TLE2027A, TLE2037A, TLE2027Y, TLE2037Y
EXCALIBUR LOW-NOISE HIGH-SPEED
PRECISION OPERATIONAL AMPLIFIERS

SLOS192A – FEBRUARY 1997 REVISED MARCH 2002

TLE20x7M operating characteristics at specified free-air temperature, $V_{CC} \pm = \pm 15\text{ V}$, $T_A = 25^\circ\text{C}$ (unless otherwise specified)

PARAMETER	TEST CONDITIONS		TLE20x7M			TLE20x7AM			UNIT
			MIN	TYP	MAX	MIN	TYP	MAX	
SR	Slew rate at unity gain	$R_L = 2\text{ k}\Omega$, $C_L = 100\text{ pF}$, See Figure 1	TLE2027	1.7	2.8		1.7	2.8	V/ μ s
			TLE2037	6*	7.5		6*	7.5	
	$R_L = 2\text{ k}\Omega$, $C_L = 100\text{ pF}$, $T_A = -55^\circ\text{C}$ to 125°C , See Figure 1	TLE2027	1			1			
		TLE2037	4.4*			4.4*			
V_n	Equivalent input noise voltage (see Figure 2)	$R_S = 20\ \Omega$, $f = 10\text{ Hz}$		3.3	8*		3.3	4.5*	nV/ $\sqrt{\text{Hz}}$
			$R_S = 20\ \Omega$, $f = 1\text{ kHz}$		2.5	4.5*		2.5	
$V_N(\text{PP})$	Peak-to-peak equivalent input noise voltage	$f = 0.1\text{ Hz}$ to 10 Hz		50	250*		50	130*	nV
I_n	Equivalent input noise current	$f = 10\text{ Hz}$		1.5	4*		1.5	4*	pA/ $\sqrt{\text{Hz}}$
		$f = 1\text{ kHz}$		0.4	0.6*		0.4	0.6*	
THD	Total harmonic distortion	$V_O = +10\text{ V}$, $A_{VD} = 1$, See Note 5	TLE2027	< 0.002%			< 0.002%		
		$V_O = +10\text{ V}$, $A_{VD} = 5$, See Note 5	TLE2037	< 0.002%			< 0.002%		
B_1	Unity-gain bandwidth (see Figure 3)	$R_L = 2\text{ k}\Omega$, $C_L = 100\text{ pF}$	TLE2027	7*	13		9*	13	MHz
			TLE2037	35	50		35	50	
B_{OM}	Maximum output-swing bandwidth	$R_L = 2\text{ k}\Omega$	TLE2027	30			30		kHz
			TLE2037	80			80		
ϕ_m	Phase margin at unity gain (see Figure 3)	$R_L = 2\text{ k}\Omega$, $C_L = 100\text{ pF}$	TLE2027	55°			55°		
			TLE2037	50°			50°		

* On products compliant to MIL-PRF-38535, this parameter is not production tested.

NOTE 5: Measured distortion of the source used in the analysis was 0.002%.

TLE2027, TLE2037, TLE2027A, TLE2037A, TLE2027Y, TLE2037Y
EXCALIBUR LOW-NOISE HIGH-SPEED
PRECISION OPERATIONAL AMPLIFIERS

SLOS192A – FEBRUARY 1997 REVISED MARCH 2002

TLE20x7Y electrical characteristics, $V_{CC\pm} = \pm 15\text{ V}$, $T_A = 25^\circ\text{C}$ (unless otherwise noted)

PARAMETER	TEST CONDITIONS	TLE20x7Y			UNIT
		MIN	TYP	MAX	
V_{IO} Input offset voltage	$V_{IC} = 0, R_S = 50\ \Omega$	20			μV
Input offset voltage long-term drift (see Note 4)		0.006			$\mu\text{V}/\text{mo}$
I_{IO} Input offset current		6			nA
I_{IB} Input bias current		15			nA
V_{ICR} Common-mode input voltage range	$R_S = 50\ \Omega$	-13 to 13			V
V_{OM+} Maximum positive peak output voltage swing	$R_L = 600\ \Omega$	12.9			V
	$R_L = 2\ \text{k}\Omega$	13.2			
V_{OM-} Maximum negative peak output voltage swing	$R_L = 600\ \Omega$	-13			V
	$R_L = 2\ \text{k}\Omega$	-13.5			
A_{VD} Large-signal differential voltage amplification	$V_O = \pm 11\ \text{V}, R_L = 2\ \text{k}\Omega$	45			V/ μV
	$V_O = \pm 10\ \text{V}, R_L = 1\ \text{k}\Omega$	38			
	$V_O = \pm 10\ \text{V}, R_L = 600\ \Omega$	19			
C_i Input capacitance		8			pF
z_o Open-loop output impedance	$I_O = 0$	50			Ω
CMRR Common-mode rejection ratio	$V_{IC} = V_{ICRmin}, R_S = 50\ \Omega$	131			dB
k_{SVR} Supply-voltage rejection ratio ($\Delta V_{CC\pm} / \Delta V_{IO}$)	$V_{CC\pm} = \pm 4\ \text{V to } \pm 18\ \text{V}, R_S = 50\ \Omega$	144			dB
I_{CC} Supply current	$V_O = 0, \text{ No load}$	3.8			mA

NOTE 4: Typical values are based on the input offset voltage shift observed through 168 hours of operating life test at $T_A = 150^\circ\text{C}$ extrapolated to $T_A = 25^\circ\text{C}$ using the Arrhenius equation and assuming an activation energy of 0.96 eV.



TLE2027, TLE2037, TLE2027A, TLE2037A, TLE2027Y, TLE2037Y
EXCALIBUR LOW-NOISE HIGH-SPEED
PRECISION OPERATIONAL AMPLIFIERS

SLOS192A – FEBRUARY 1997 REVISED MARCH 2002

TLE20x7Y operating characteristics at specified free-air temperature, $V_{CC \pm} = \pm 15$ V

PARAMETER		TEST CONDITIONS		TLE20x7Y			UNIT
				MIN	TYP	MAX	
SR	Slew rate at unity gain	$R_L = 2 \text{ k}\Omega$, $C_L = 100 \text{ pF}$, See Figure 1	TLE2027	2.8		V/ μ s	
			TLE2037	7.5			
V_n	Equivalent input noise voltage (see Figure 2)	$R_S = 20 \Omega$, $f = 10 \text{ Hz}$ $R_S = 20 \Omega$, $f = 1 \text{ kHz}$	3.3		nV/ $\sqrt{\text{Hz}}$		
			2.5				
$V_{N(PP)}$	Peak-to-peak equivalent input noise voltage	$f = 0.1 \text{ Hz to } 10 \text{ Hz}$	50		nV		
I_n	Equivalent input noise current	$f = 10 \text{ Hz}$	10		pA/ $\sqrt{\text{Hz}}$		
		$f = 1 \text{ kHz}$	0.8				
THD	Total harmonic distortion	$V_O = +10 \text{ V}$, $A_{VD} = 1$, See Note 5	TLE2027	<0.002%			
		$V_O = +10 \text{ V}$, $A_{VD} = 5$, See Note 5	TLE2037	<0.002%			
B_1	Unity-gain bandwidth (see Figure 3)	$R_L = 2 \text{ k}\Omega$, $C_L = 100 \text{ pF}$	TLE2027	13		MHz	
			TLE2037	50			
B_{OM}	Maximum output-swing bandwidth	$R_L = 2 \text{ k}\Omega$	TLE2027	30		kHz	
			TLE2037	80			
ϕ_m	Phase margin at unity gain (see Figure 3)	$R_L = 2 \text{ k}\Omega$, $C_L = 100 \text{ pF}$	TLE2027	55°			
			TLE2037	50°			

NOTE 5: Measured distortion of the source used in the analysis was 0.002%.

TLE2027, TLE2037, TLE2027A, TLE2037A, TLE2027Y, TLE2037Y
EXCALIBUR LOW-NOISE HIGH-SPEED
PRECISION OPERATIONAL AMPLIFIERS

SLOS192A – FEBRUARY 1997 REVISED MARCH 2002

PARAMETER MEASUREMENT INFORMATION

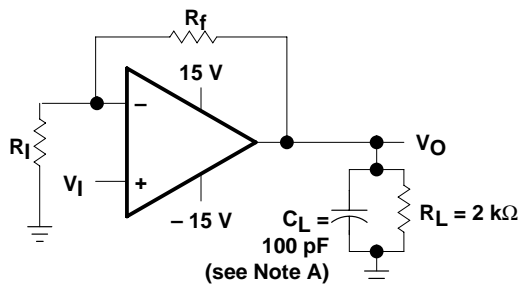

NOTE A: C_L includes fixture capacitance.

Figure 1. Slew-Rate Test Circuit

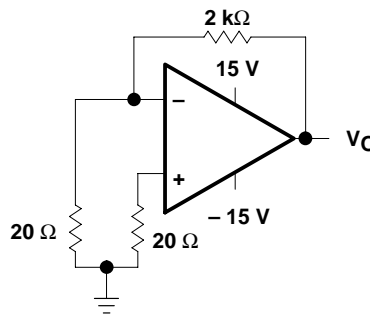
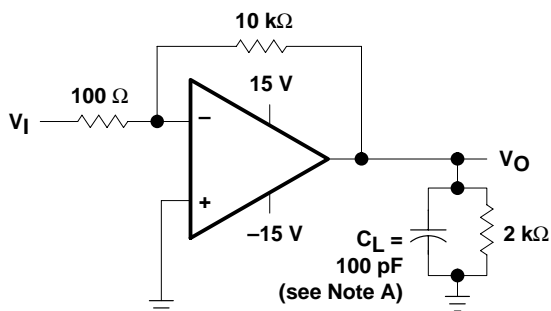
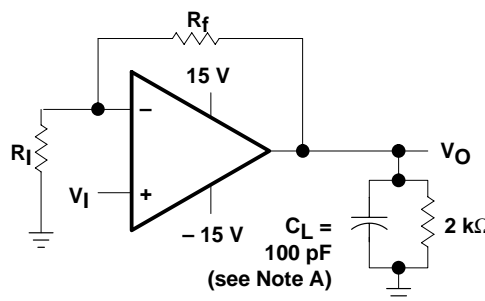

Figure 2. Noise-Voltage Test Circuit



NOTE A: C_L includes fixture capacitance.

Figure 3. Unity-Gain Bandwidth and Phase-Margin Test Circuit (TLE2027 Only)



NOTES: A. C_L includes fixture capacitance.
 B. For the TLE2037 and TLE2037A, A_{VD} must be ≥ 5 .

Figure 4. Small-Signal Pulse-Response Test Circuit

typical values

Typical values presented in this data sheet represent the median (50% point) of device parametric performance.

initial estimates of parameter distributions

In the ongoing program of improving data sheets and supplying more information to our customers, Texas Instruments has added an estimate of not only the typical values but also the spread around these values. These are in the form of distribution bars that show the 95% (upper) points and the 5% (lower) points from the characterization of the initial wafer lots of this new device type (see Figure 5). The distribution bars are shown at the points where data was actually collected. The 95% and 5% points are used instead of ± 3 sigma since some of the distributions are not true Gaussian distributions.

The number of units tested and the number of different wafer lots used are on all of the graphs where distribution bars are shown. As noted in Figure 5, there were a total of 835 units from two wafer lots. In this case, there is a good estimate for the within-lot variability and a possibly poor estimate of the lot-to-lot variability. This is always the case on newly released products since there can only be data available from a few wafer lots.

The distribution bars are not intended to replace the minimum and maximum limits in the electrical tables. Each distribution bar represents 90% of the total units tested at a specific temperature. While 10% of the units tested fell outside any given distribution bar, this should not be interpreted to mean that the same individual devices fell outside every distribution bar.

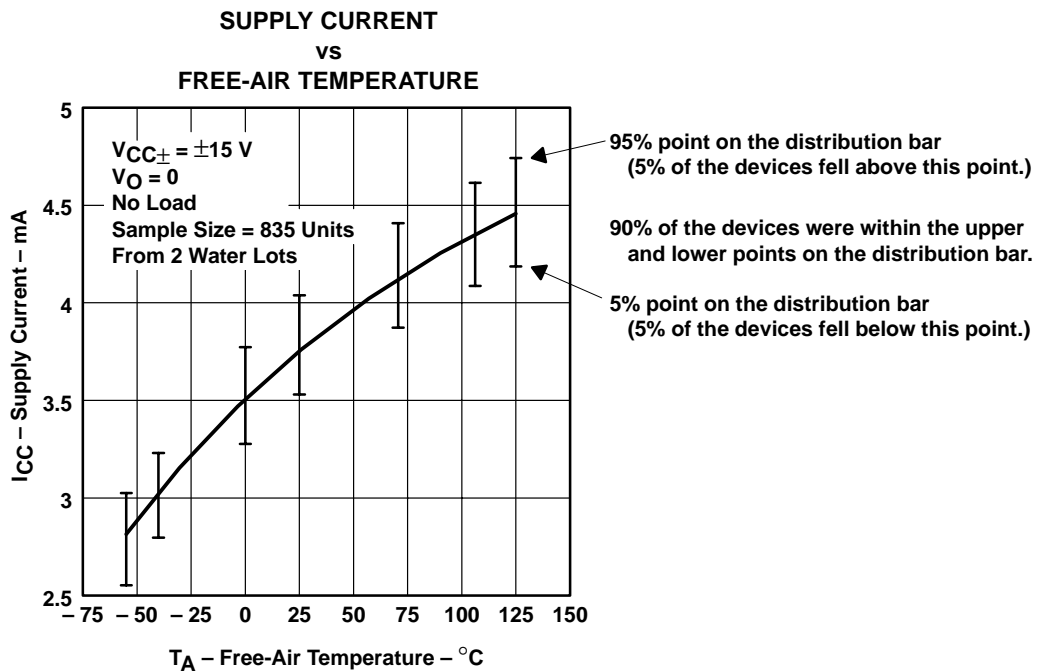

Figure 5. Sample Graph With Distribution Bars

TLE2027, TLE2037, TLE2027A, TLE2037A, TLE2027Y, TLE2037Y
EXCALIBUR LOW-NOISE HIGH-SPEED
PRECISION OPERATIONAL AMPLIFIERS

SLOS192A – FEBRUARY 1997 REVISED MARCH 2002

TYPICAL CHARACTERISTICS

Table of Graphs

		FIGURE	
V_{IO}	Input offset voltage	Distribution	6, 7
ΔV_{IO}	Input offset voltage change	vs Time after power on	8, 9
I_{IO}	Input offset current	vs Free-air temperature	10
I_{IB}	Input bias current	vs Free-air temperature vs Common-mode input voltage	11 12
I_I	Input current	vs Differential input voltage	13
$V_{O(PP)}$	Maximum peak-to-peak output voltage	vs Frequency	14, 15
V_{OM}	Maximum (positive/negative) peak output voltage	vs Load resistance vs Free-air temperature	16, 17 18, 19
A_{VD}	Large-signal differential voltage amplification	vs Supply voltage vs Load resistance vs Frequency vs Free-air temperature	20 21 22 – 25 26
z_o	Output impedance	vs Frequency	27
CMRR	Common-mode rejection ratio	vs Frequency	28
k_{SVR}	Supply-voltage rejection ratio	vs Frequency	29
I_{OS}	Short-circuit output current	vs Supply voltage vs Elapsed time vs Free-air temperature	30, 31 32, 33 34, 35
I_{CC}	Supply current	vs Supply voltage vs Free-air temperature	36 37
	Voltage-follower pulse response	Small signal Large signal	38, 40 39, 41
V_n	Equivalent input noise voltage	vs Frequency	42
	Noise voltage (referred to input)	Over 10-second interval	43
B_1	Unity-gain bandwidth	vs Supply voltage vs Load capacitance	44 45
	Gain bandwidth product	vs Supply voltage vs Load capacitance	46 47
SR	Slew rate	vs Free-air temperature	48, 49
ϕ_m	Phase margin	vs Supply voltage vs Load capacitance vs Free-air temperature	50, 51 52, 53 54, 55
	Phase shift	vs Frequency	22 – 25



TYPICAL CHARACTERISTICS

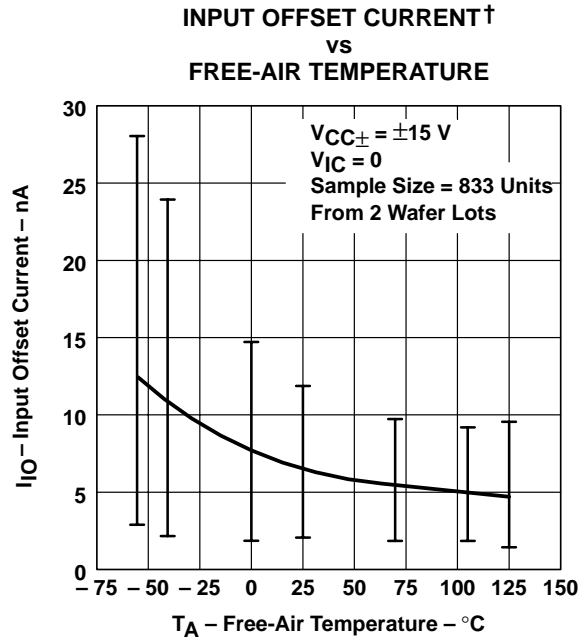
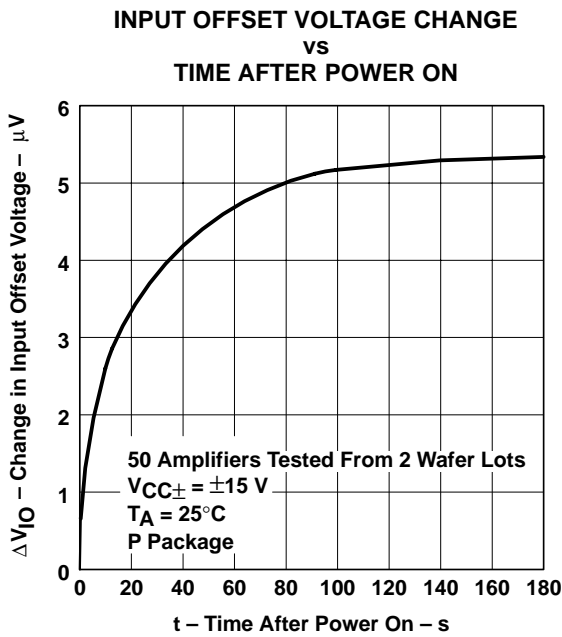
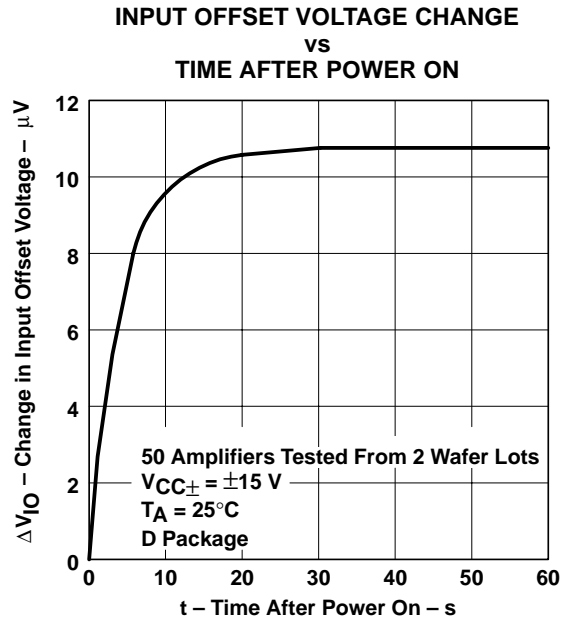
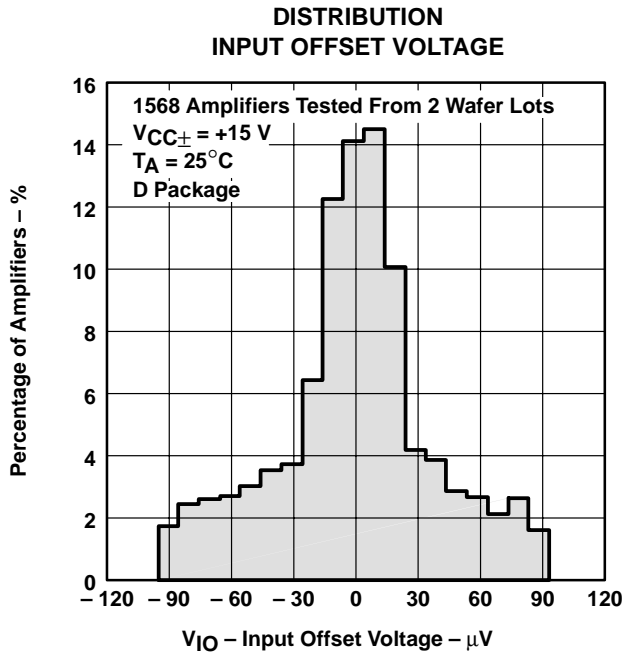

† Data at high and low temperatures are applicable only within the rated operating free-air temperature ranges of the various devices.

TLE2027, TLE2037, TLE2027A, TLE2037A, TLE2027Y, TLE2037Y
EXCALIBUR LOW-NOISE HIGH-SPEED
PRECISION OPERATIONAL AMPLIFIERS

SLOS192A – FEBRUARY 1997 REVISED MARCH 2002

TYPICAL CHARACTERISTICS

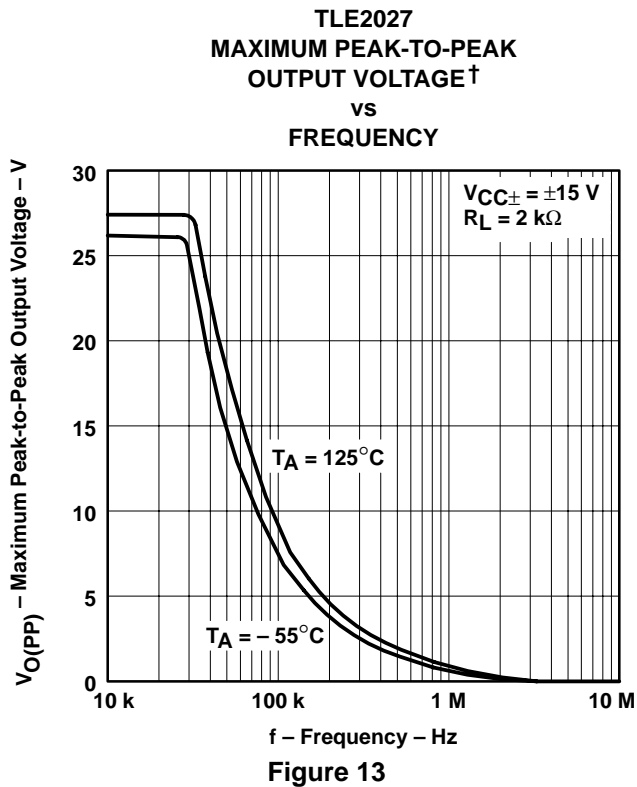
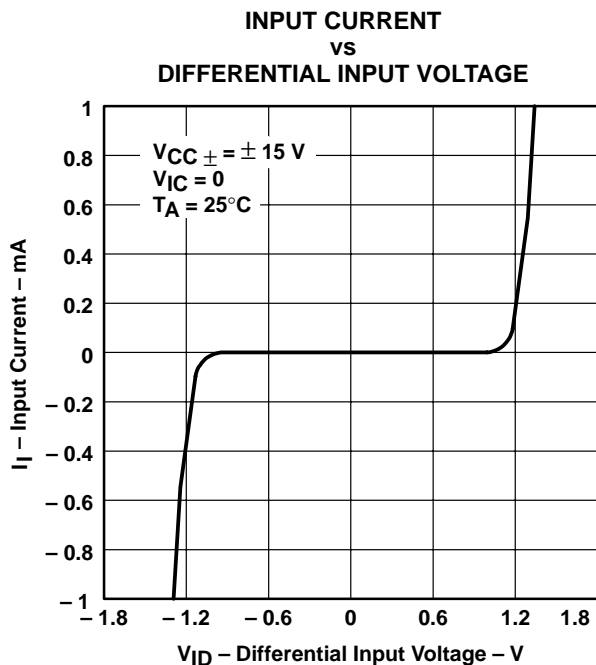
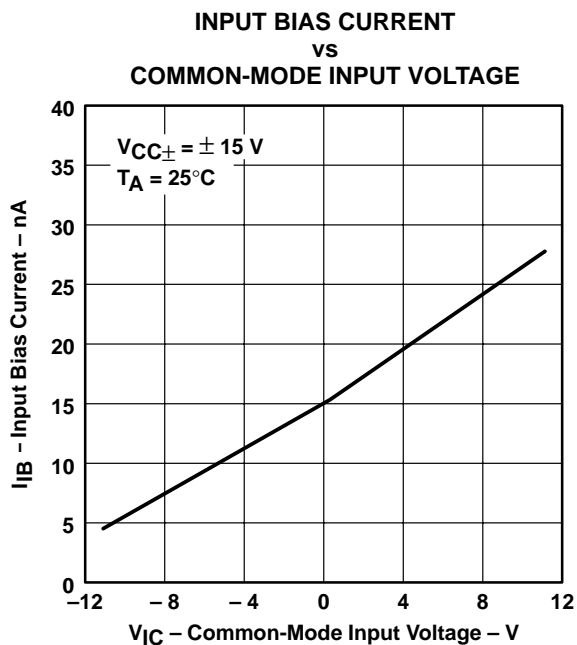
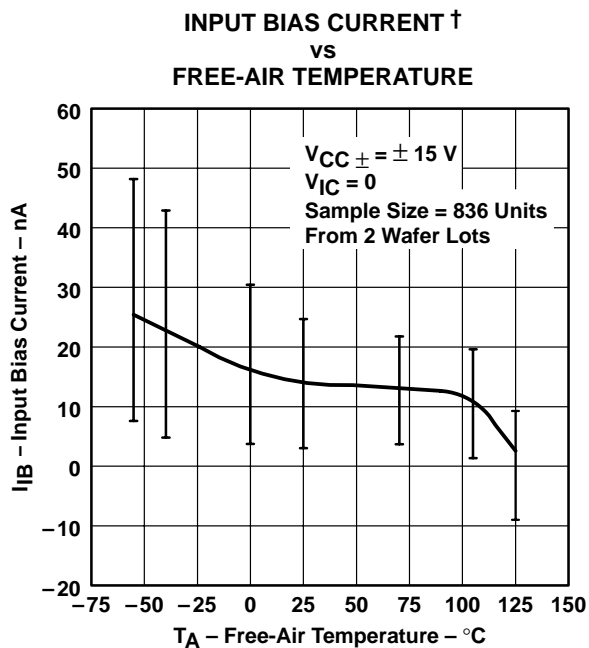

† Data at high and low temperatures are applicable only within the rated operating free-air temperature ranges of the various devices.



TYPICAL CHARACTERISTICS

**TLE2037
 MAXIMUM PEAK-TO-PEAK
 OUTPUT VOLTAGE†
 vs
 FREQUENCY**

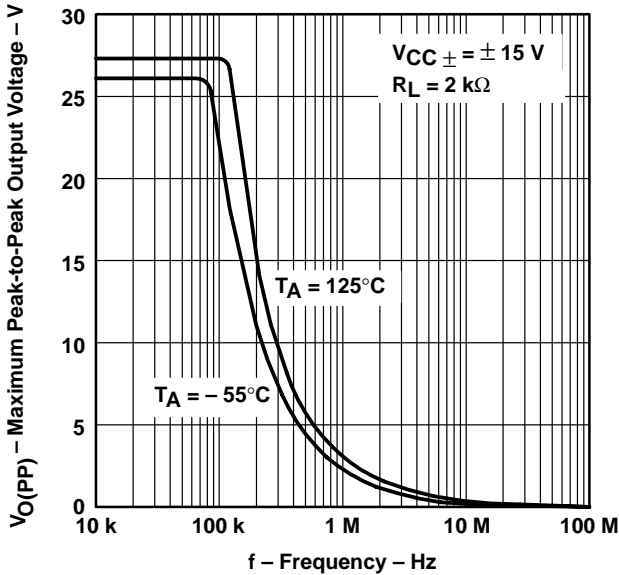

Figure 14

**MAXIMUM POSITIVE PEAK
 OUTPUT VOLTAGE
 vs
 LOAD RESISTANCE**

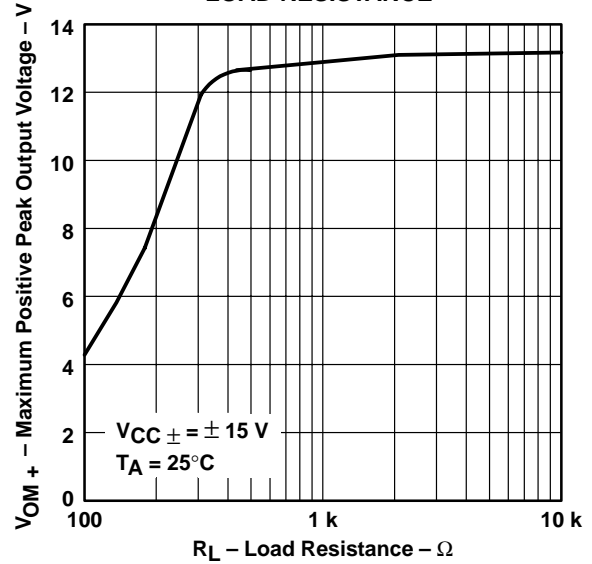

Figure 15

**MAXIMUM NEGATIVE PEAK
 OUTPUT VOLTAGE
 vs
 LOAD RESISTANCE**

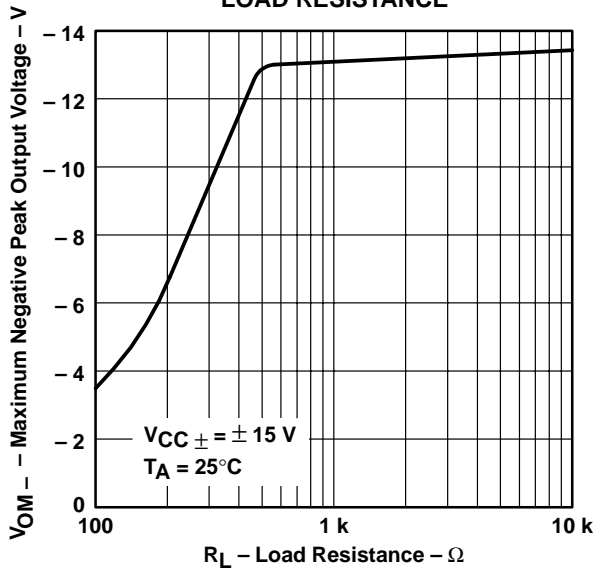

Figure 16

**MAXIMUM POSITIVE PEAK
 OUTPUT VOLTAGE†
 vs
 FREE-AIR TEMPERATURE**

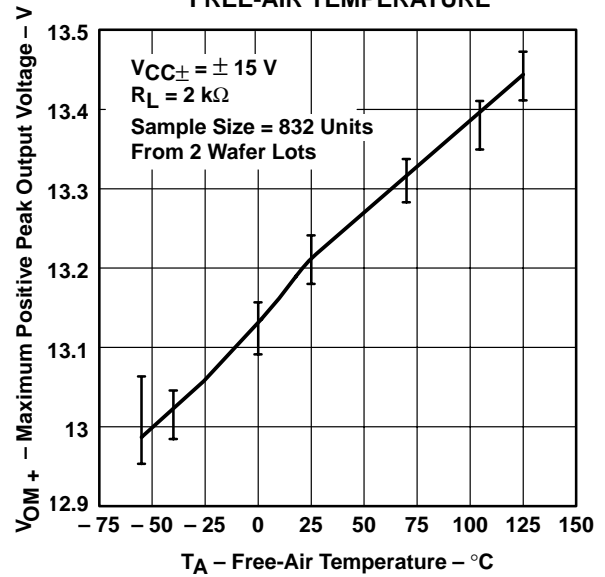

Figure 17

† Data at high and low temperatures are applicable only within the rated operating free-air temperature ranges of the various devices.

TLE2027, TLE2037, TLE2027A, TLE2037A, TLE2027Y, TLE2037Y
EXCALIBUR LOW-NOISE HIGH-SPEED
PRECISION OPERATIONAL AMPLIFIERS

SLOS192A – FEBRUARY 1997 REVISED MARCH 2002

TYPICAL CHARACTERISTICS

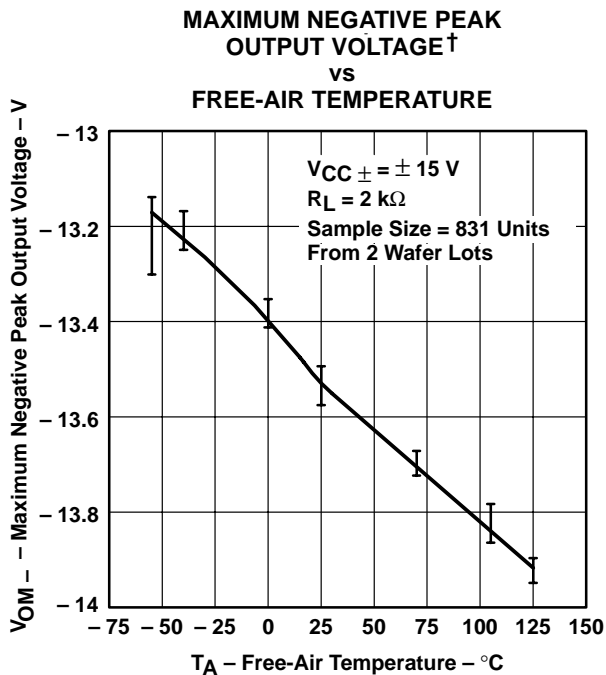

Figure 18

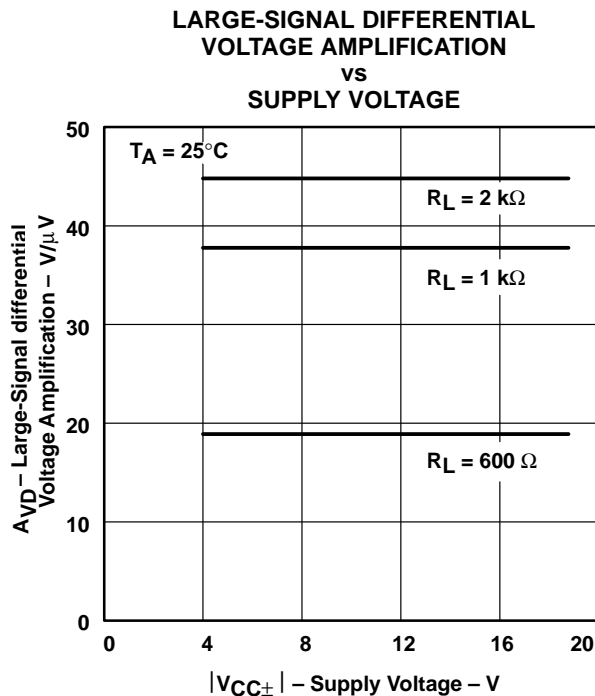

Figure 19

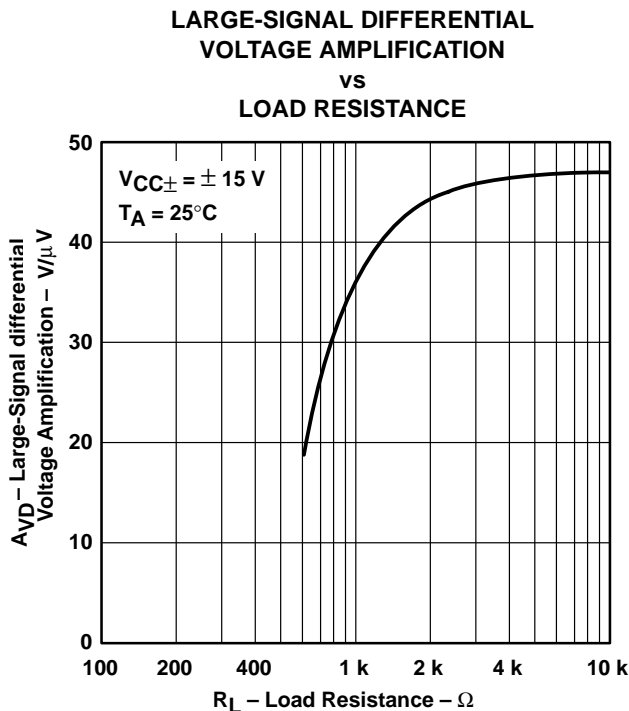

Figure 20

† Data at high and low temperatures are applicable only within the rated operating free-air temperature ranges of the various devices.



TYPICAL CHARACTERISTICS

**TLE2027
 LARGE-SIGNAL DIFFERENTIAL VOLTAGE
 AMPLIFICATION AND PHASE SHIFT
 vs
 FREQUENCY**

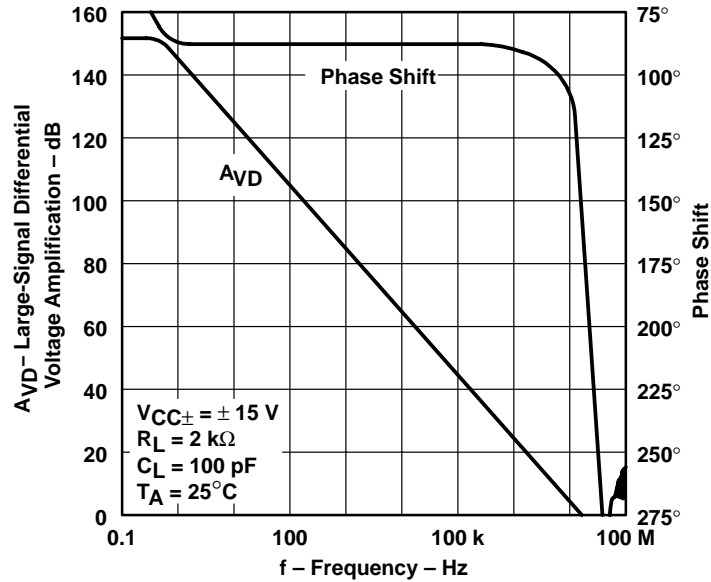

Figure 21

**TLE2037
 LARGE-SIGNAL DIFFERENTIAL VOLTAGE
 AMPLIFICATION AND PHASE SHIFT
 vs
 FREQUENCY**

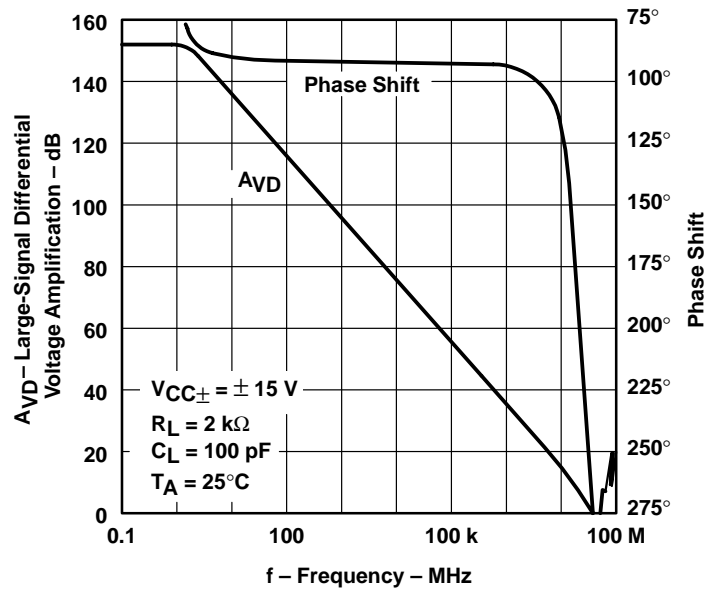

Figure 22

TLE2027, TLE2037, TLE2027A, TLE2037A, TLE2027Y, TLE2037Y
EXCALIBUR LOW-NOISE HIGH-SPEED
PRECISION OPERATIONAL AMPLIFIERS

SLOS192A – FEBRUARY 1997 REVISED MARCH 2002

TYPICAL CHARACTERISTICS

TLE2027
LARGE-SIGNAL DIFFERENTIAL VOLTAGE
AMPLIFICATION AND PHASE SHIFT
vs
FREQUENCY

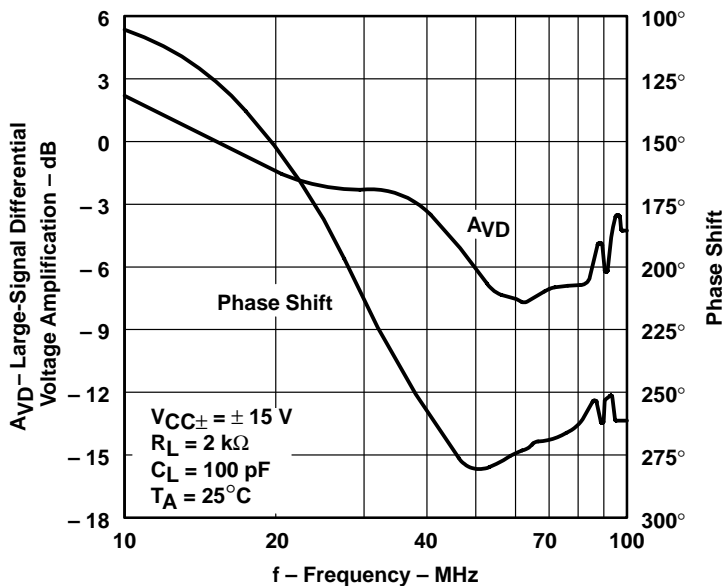

Figure 23

TLE2037
LARGE-SIGNAL DIFFERENTIAL VOLTAGE
AMPLIFICATION AND PHASE SHIFT
vs
FREQUENCY

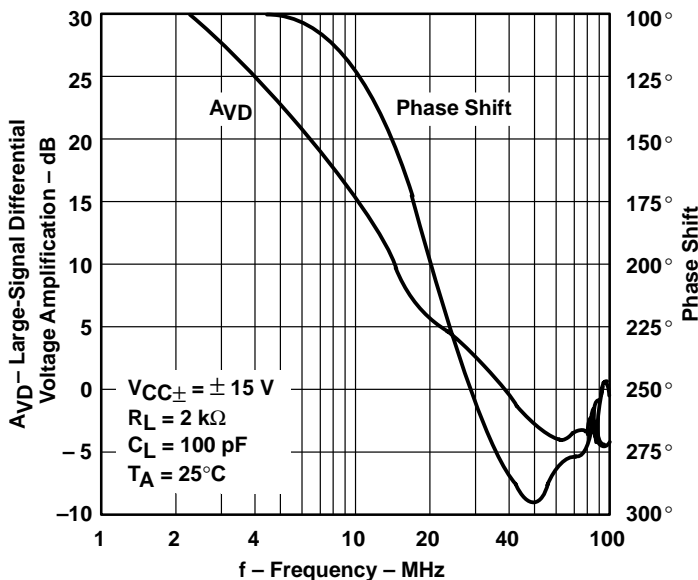

Figure 24



TYPICAL CHARACTERISTICS

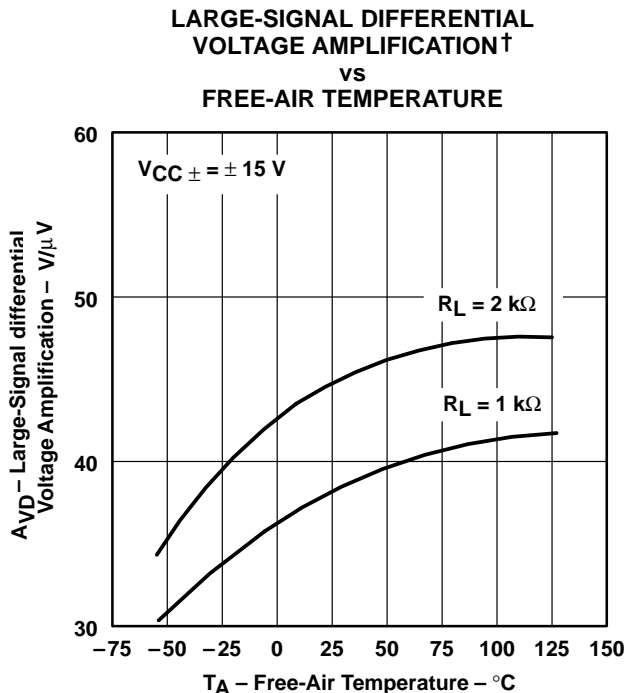
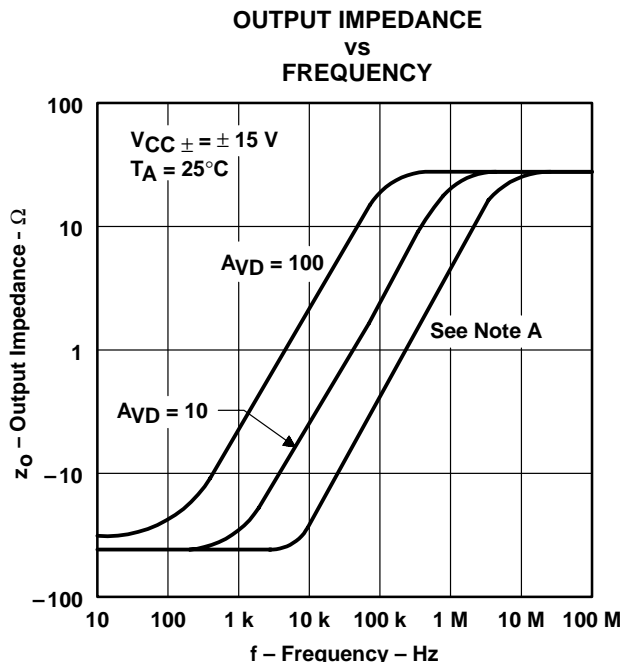

Figure 25



NOTE A: For this curve, the TLE2027 is $A_{VD} = 1$ and the TLE2037 is $A_{VD} = 5$.

Figure 26

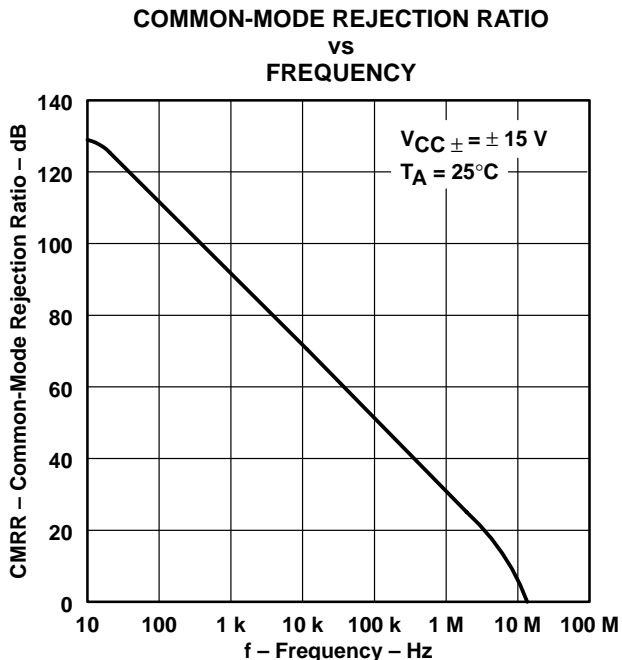

Figure 27

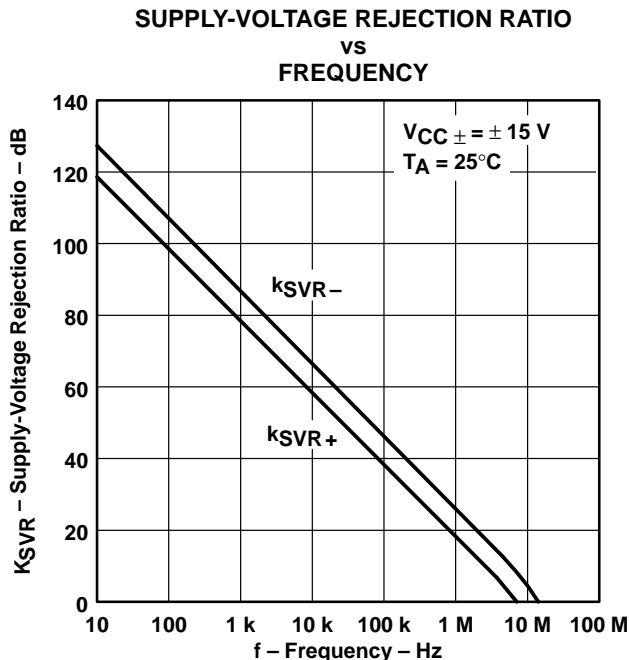

Figure 28

† Data at high and low temperatures are applicable only within the rated operating free-air temperature ranges of the various devices.

TYPICAL CHARACTERISTICS

**SHORT-CIRCUIT OUTPUT CURRENT
 vs
 SUPPLY VOLTAGE**

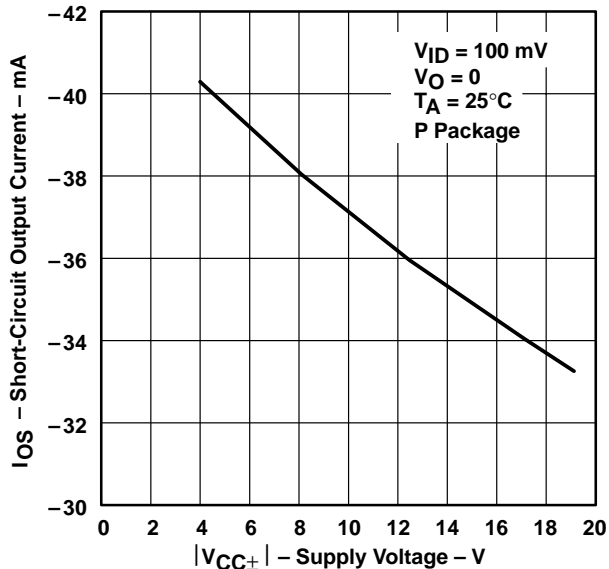

Figure 29

**SHORT-CIRCUIT OUTPUT CURRENT
 vs
 SUPPLY VOLTAGE**

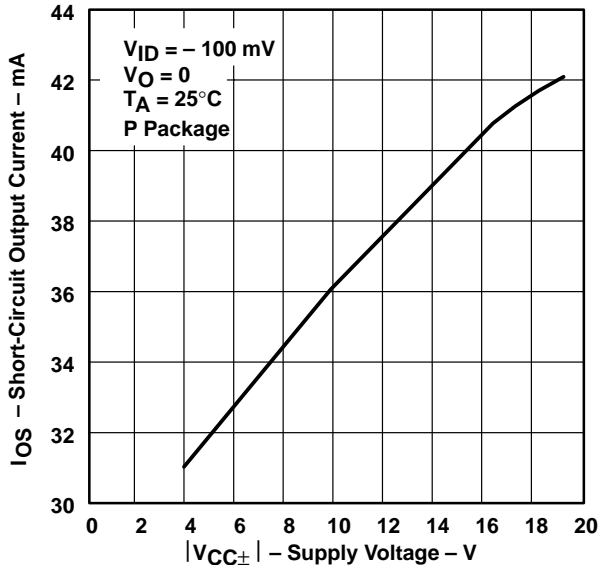

Figure 30

**SHORT-CIRCUIT OUTPUT CURRENT
 vs
 ELAPSED TIME**

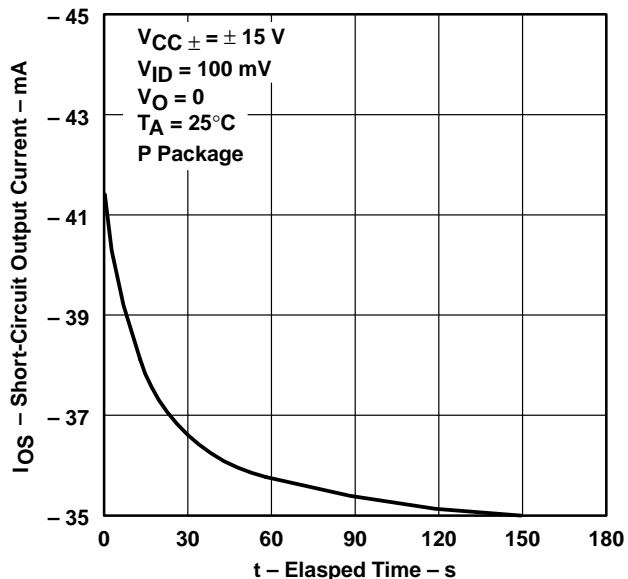

Figure 31

**SHORT-CIRCUIT OUTPUT CURRENT
 vs
 ELAPSED TIME**

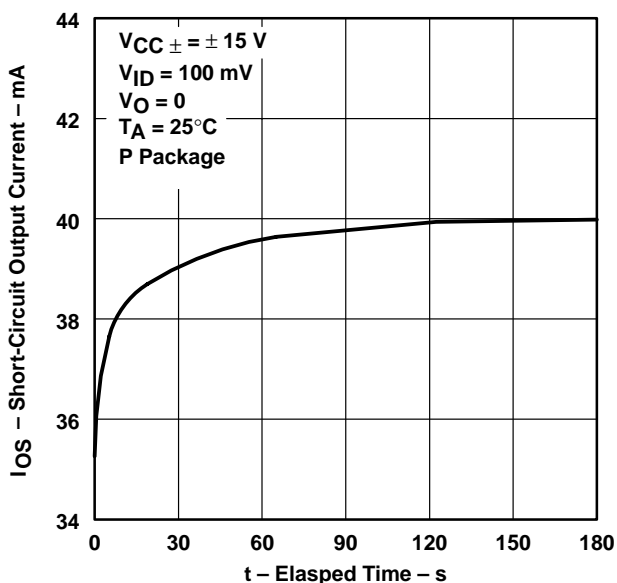

Figure 32

TYPICAL CHARACTERISTICS

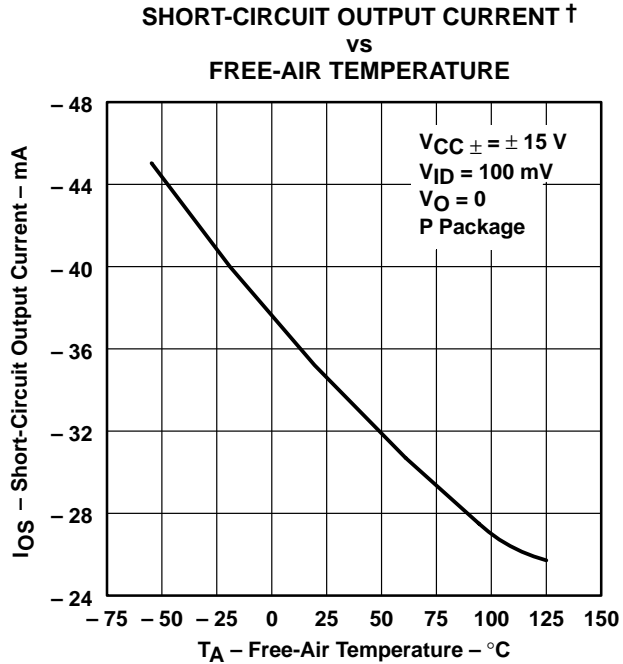

Figure 33

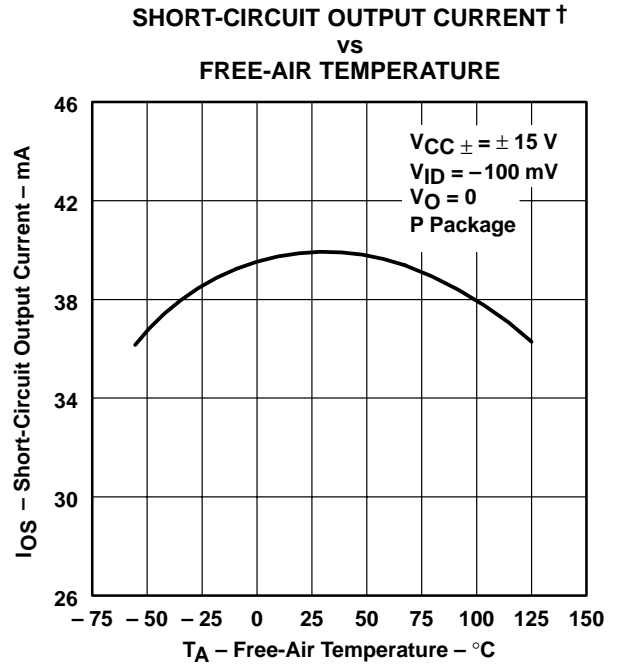

Figure 34

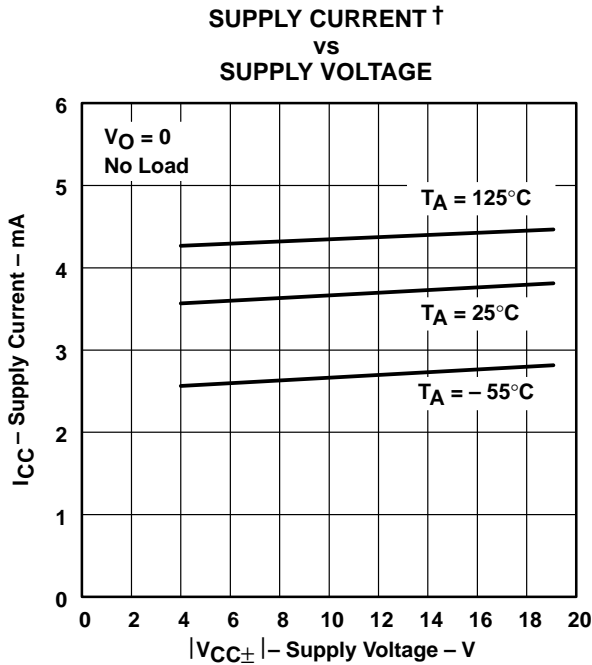

Figure 35

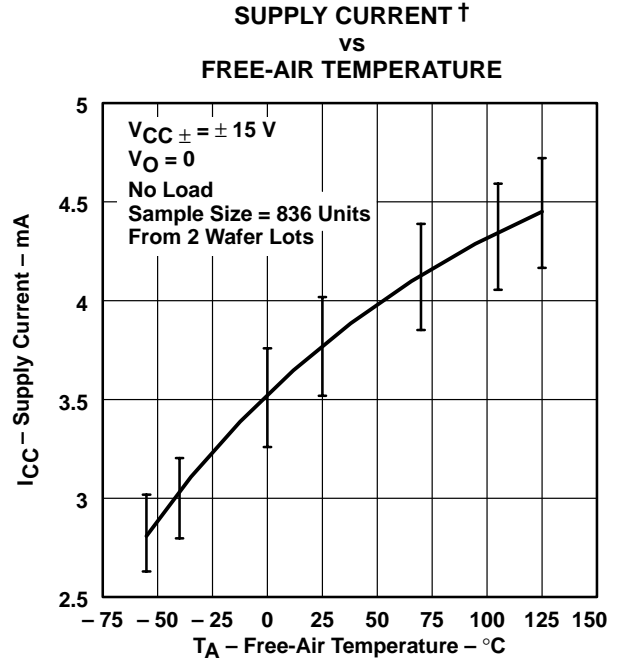

Figure 36

† Data at high and low temperatures are applicable only within the rated operating free-air temperature ranges of the various devices.

TLE2027, TLE2037, TLE2027A, TLE2037A, TLE2027Y, TLE2037Y
EXCALIBUR LOW-NOISE HIGH-SPEED
PRECISION OPERATIONAL AMPLIFIERS

SLOS192A – FEBRUARY 1997 REVISED MARCH 2002

TYPICAL CHARACTERISTICS

TLE2027
VOLTAGE-FOLLOWER
SMALL-SIGNAL
PULSE RESPONSE

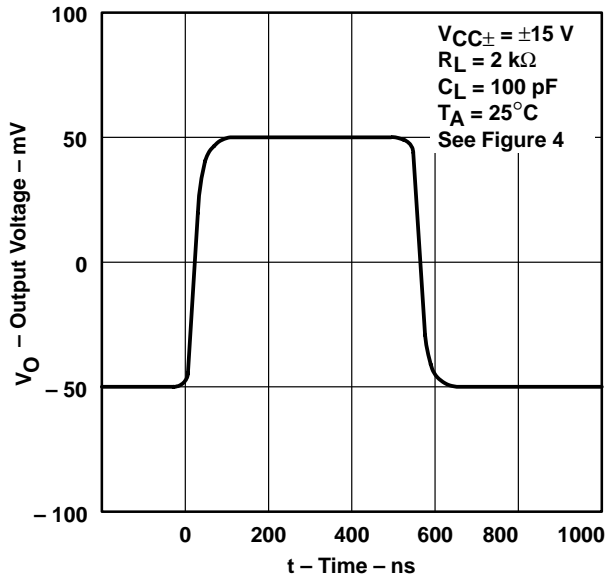

Figure 37

TLE2027
VOLTAGE-FOLLOWER
LARGE-SIGNAL
PULSE RESPONSE

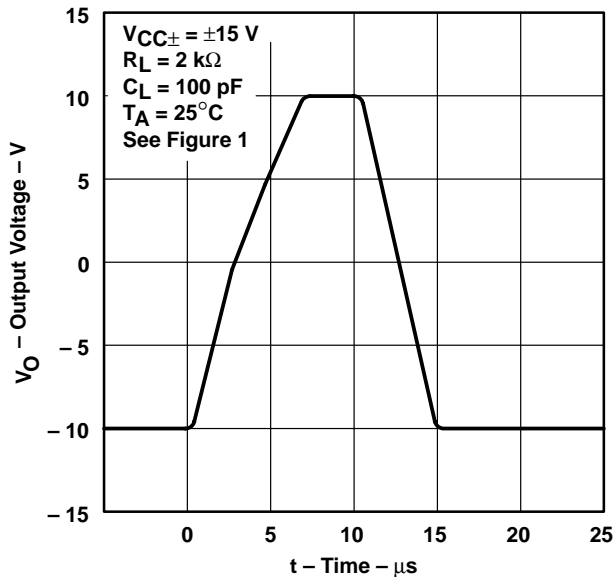

Figure 38

TLE2037
VOLTAGE-FOLLOWER
SMALL-SIGNAL
PULSE RESPONSE

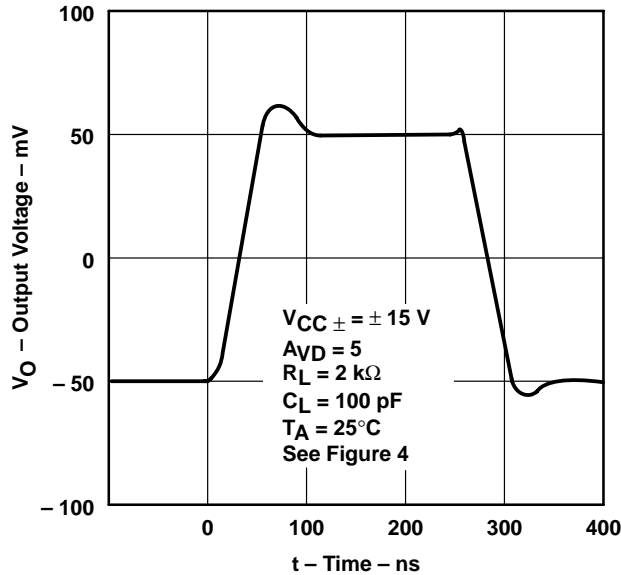

Figure 39

TLE2037
VOLTAGE-FOLLOWER
LARGE-SIGNAL
PULSE RESPONSE

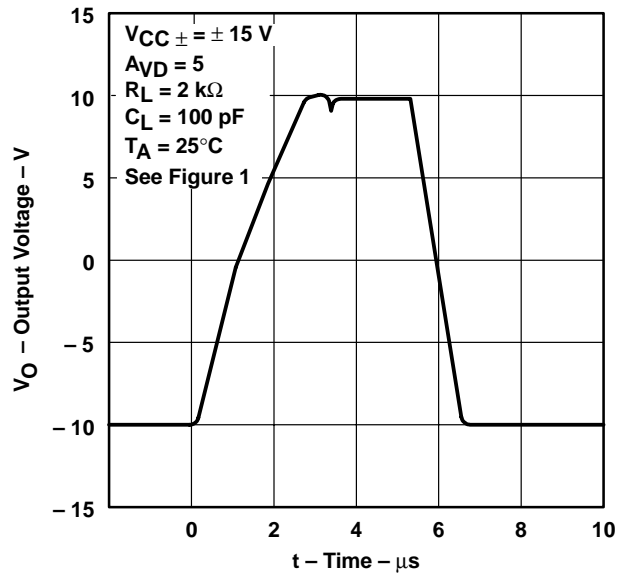
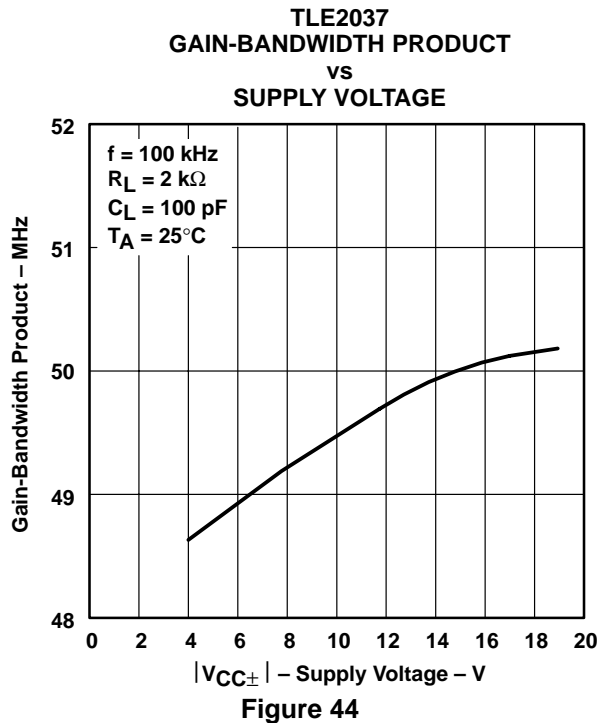
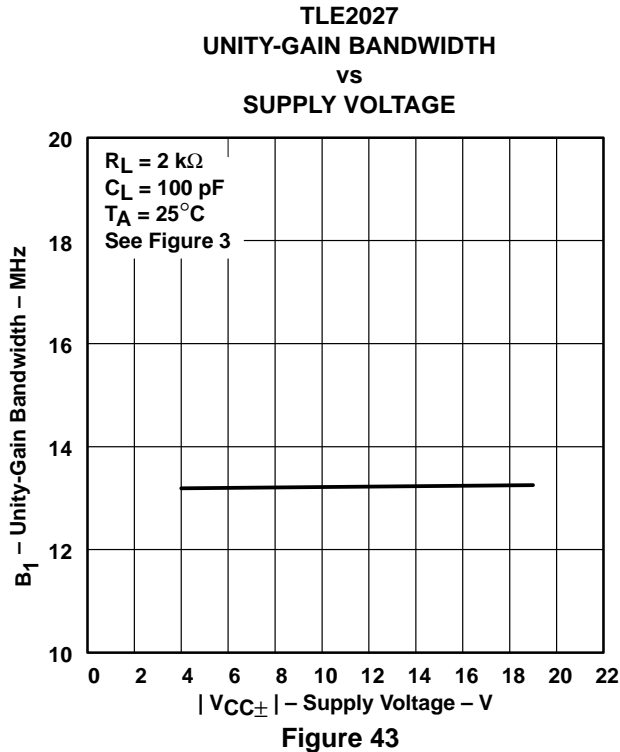
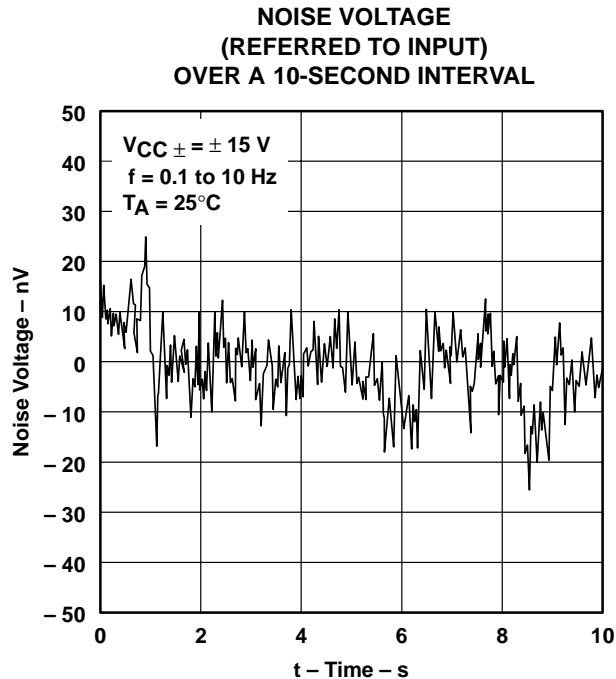
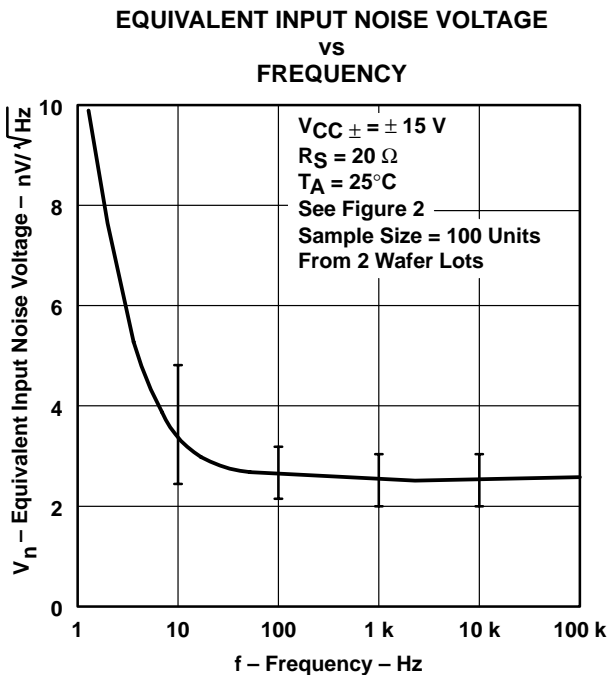

Figure 40



TYPICAL CHARACTERISTICS



TLE2027, TLE2037, TLE2027A, TLE2037A, TLE2027Y, TLE2037Y
EXCALIBUR LOW-NOISE HIGH-SPEED
PRECISION OPERATIONAL AMPLIFIERS

SLOS192A – FEBRUARY 1997 REVISED MARCH 2002

TYPICAL CHARACTERISTICS

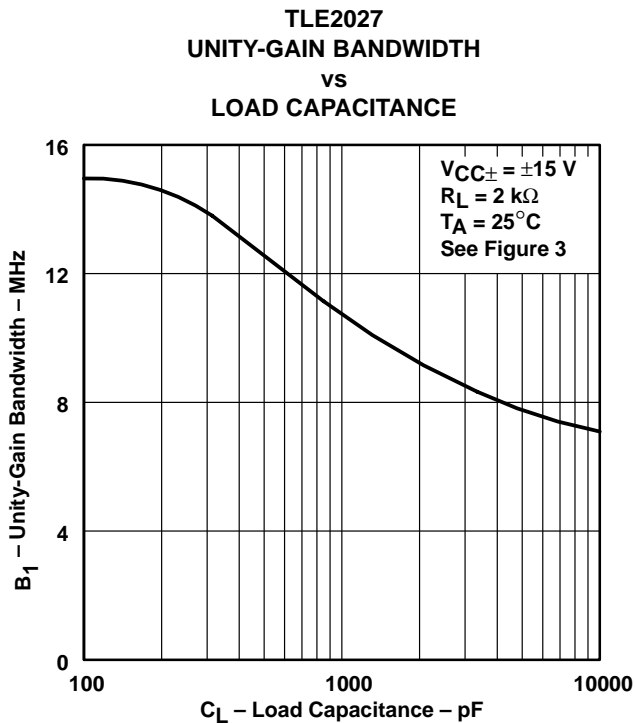

Figure 45

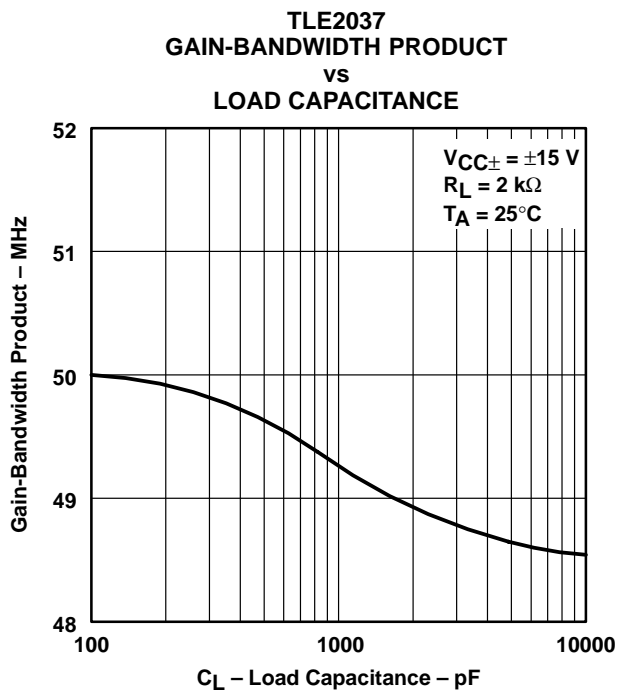

Figure 46

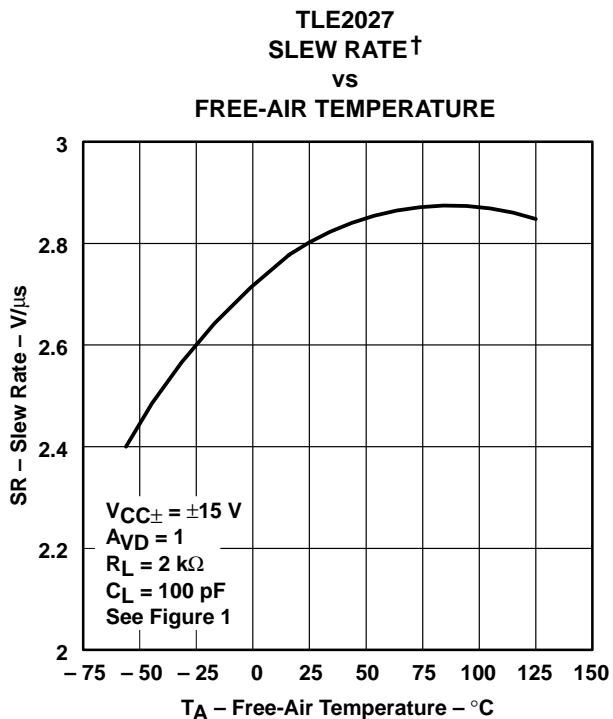

Figure 47

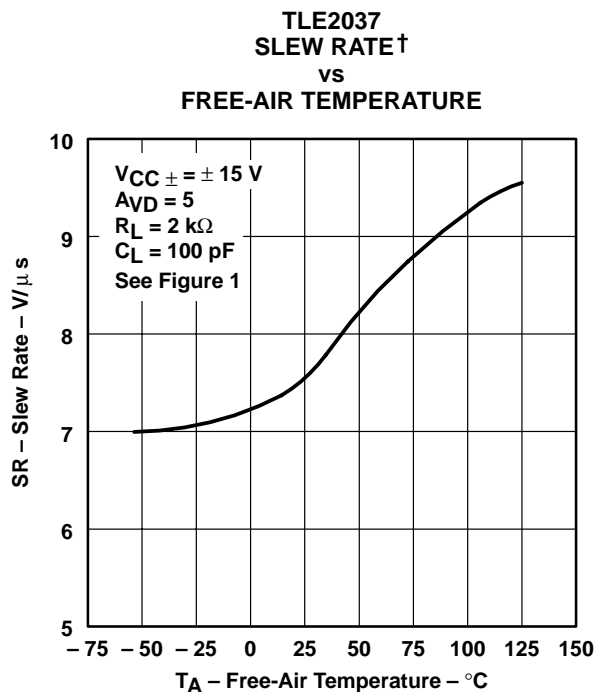

Figure 48

† Data at high and low temperatures are applicable only within the rated operating free-air temperature ranges of the various devices.



TYPICAL CHARACTERISTICS

**TLE2027
 PHASE MARGIN
 vs
 SUPPLY VOLTAGE**

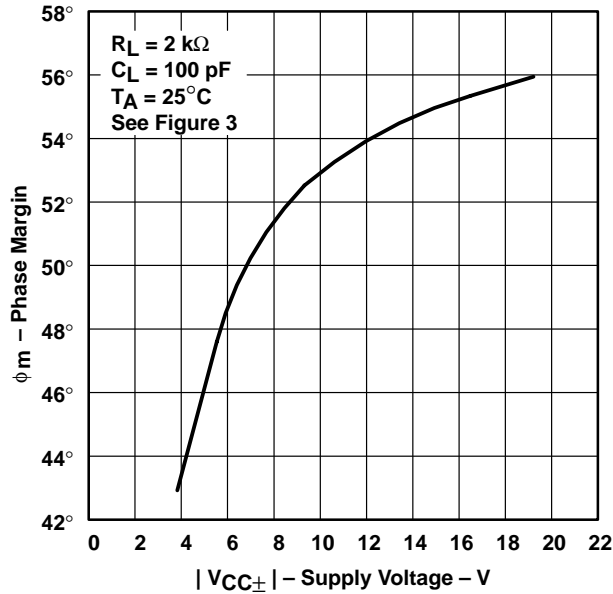

Figure 49

**TLE2037
 PHASE MARGIN
 vs
 SUPPLY VOLTAGE**

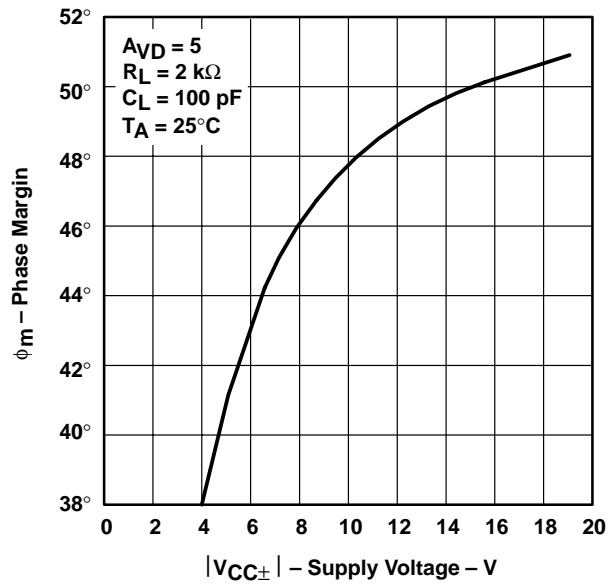

Figure 50

**TLE2027
 PHASE MARGIN
 vs
 LOAD CAPACITANCE**

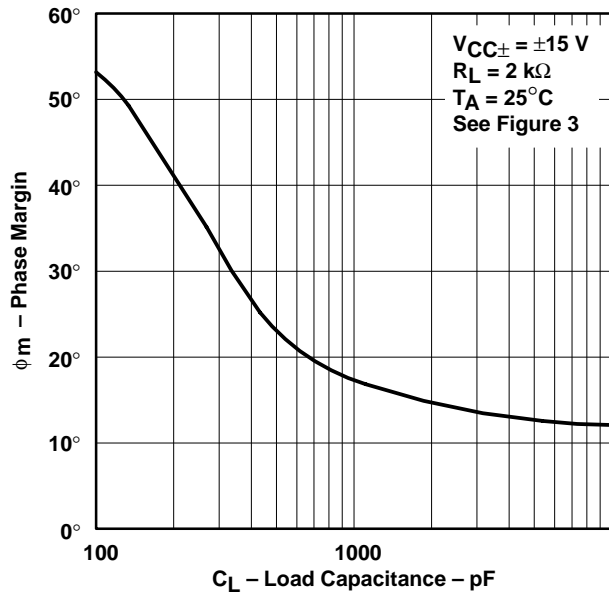

Figure 51

**TLE2037
 PHASE MARGIN
 vs
 LOAD CAPACITANCE**

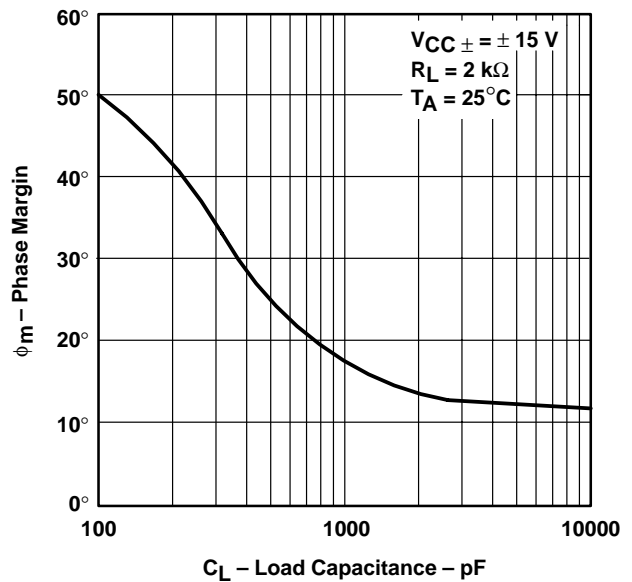

Figure 52

TLE2027, TLE2037, TLE2027A, TLE2037A, TLE2027Y, TLE2037Y
EXCALIBUR LOW-NOISE HIGH-SPEED
PRECISION OPERATIONAL AMPLIFIERS

SLOS192A – FEBRUARY 1997 REVISED MARCH 2002

TYPICAL CHARACTERISTICS

TLE2027
PHASE MARGIN†
vs
FREE-AIR TEMPERATURE

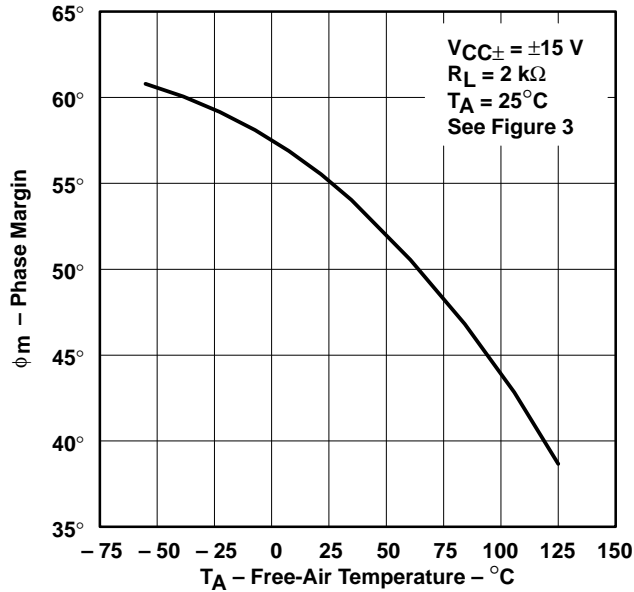

Figure 53

TLE2037
PHASE MARGIN†
vs
FREE-AIR TEMPERATURE

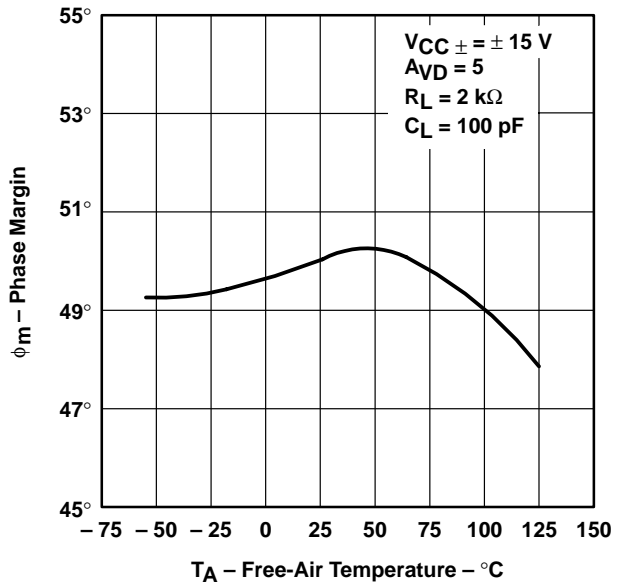

Figure 54

† Data at high and low temperatures are applicable only within the rated operating free-air temperature ranges of the various devices.

APPLICATION INFORMATION

input offset voltage nulling

The TLE2027 and TLE2037 series offers external null pins that can be used to further reduce the input offset voltage. The circuits of Figure 55 can be connected as shown if the feature is desired. If external nulling is not needed, the null pins may be left disconnected.

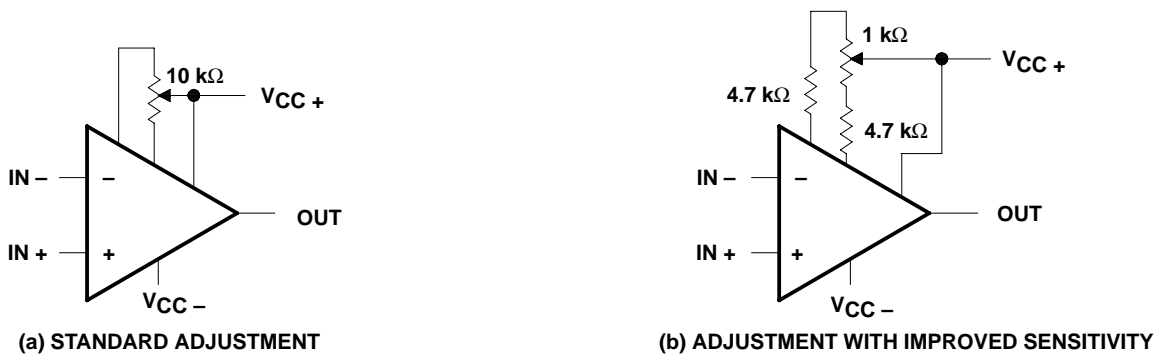

Figure 55. Input Offset Voltage Nulling Circuits

voltage-follower applications

The TLE2027 circuitry includes input-protection diodes to limit the voltage across the input transistors; however, no provision is made in the circuit to limit the current if these diodes are forward biased. This condition can occur when the device is operated in the voltage-follower configuration and driven with a fast, large-signal pulse. It is recommended that a feedback resistor be used to limit the current to a maximum of 1 mA to prevent degradation of the device. Also, this feedback resistor forms a pole with the input capacitance of the device. For feedback resistor values greater than 10 kΩ, this pole degrades the amplifier phase margin. This problem can be alleviated by adding a capacitor (20 pF to 50 pF) in parallel with the feedback resistor (see Figure 56).

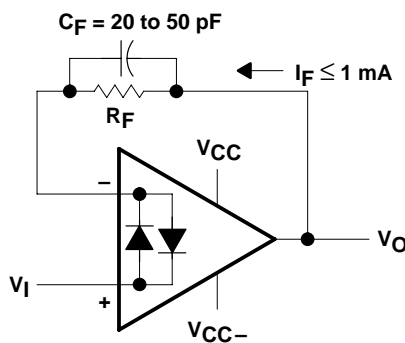

Figure 56. Voltage Follower

TLE2027, TLE2037, TLE2027A, TLE2037A, TLE2027Y, TLE2037Y EXCALIBUR LOW-NOISE HIGH-SPEED PRECISION OPERATIONAL AMPLIFIERS

SLOS192A – FEBRUARY 1997 REVISED MARCH 2002

APPLICATION INFORMATION

macromodel information

Macromodel information provided was derived using Microsim *Parts*™, the model generation software used with Microsim *PSpice*™. The Boyle macromodel (see Note 6) and subcircuit in Figure 57, Figure 58, and Figure 59 were generated using the TLE20x7 typical electrical and operating characteristics at 25°C. Using this information, output simulations of the following key parameters can be generated to a tolerance of 20% (in most cases):

- Maximum positive output voltage swing
- Maximum negative output voltage swing
- Slew rate
- Quiescent power dissipation
- Input bias current
- Open-loop voltage amplification
- Gain-bandwidth product
- Common-mode rejection ratio
- Phase margin
- DC output resistance
- AC output resistance
- Short-circuit output current limit

NOTE 6: G. R. Boyle, B. M. Cohn, D. O. Pederson, and J. E. Solomon, "Macromodeling of Integrated Circuit Operational Amplifiers", IEEE Journal of Solid-State Circuits, SC-9, 353 (1974).

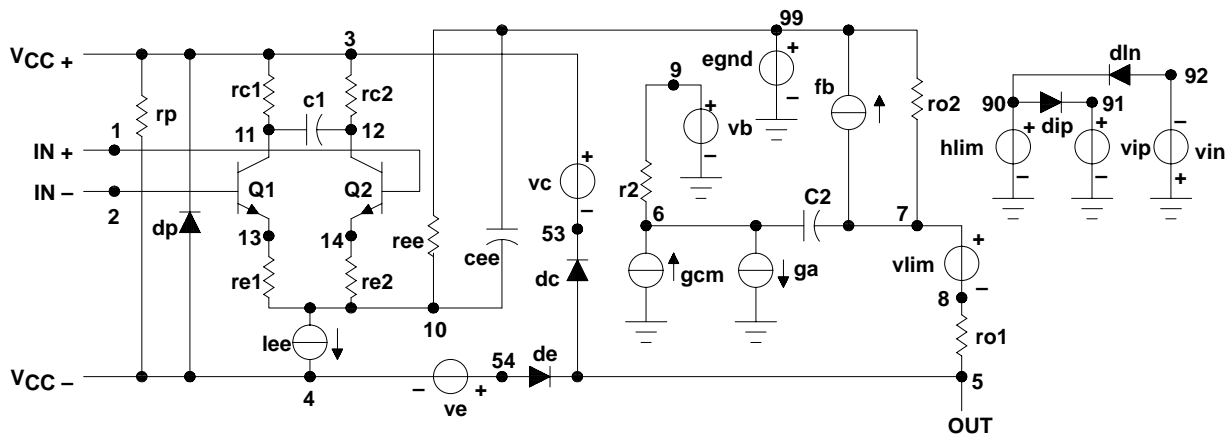

Figure 57. Boyle Macromodel

PSpice and *Parts* are trademarks of MicroSim Corporation.



POST OFFICE BOX 655303 • DALLAS, TEXAS 75265

APPLICATION INFORMATION

macromodel information (continued)

```
.subckt TLE2027 1 2 3 4 5
*
c1      11  12  4.003E-12
c2      6   7   20.00E-12
dc      5  53  dz
de      54  5   dz
dlp     90  91  dz
dln     92  90  dx
dp      4   3   dz
egnd    99   0  poly(2) (3,0)
(4,0) 0 5 .5
fb      7   99  poly(5) vb vc
ve vlp vln 0 954.8E6 -1E9 1E9 1E9
-1E9
ga      6   0  11  12
2.062E-3
gcm     0   6  10  99
531.3E-12
iee     10  4   dc 56.01E-6
hlim    90  0   vlim 1K
ql      11  2   13 qx
q2      12  1   14 qx
r2      6   9   100.0E3
rc1     3   11  530.5
rc2     3   12  530.5
re1     13  10  -393.2
re2     14  10  -393.2
ree     10  99  3.571E6
ro1     8   5   25
ro2     7   99  25
rp      3   4   8.013E3
vb      9   0   dc 0
vc      3   53  dc 2.400
ve      54  4   dc 2.100
vlim    7   8   dc 0
vlp     91  0   dc 40
vln     0   92  dc 40
.modeldx D(Is=800.0E-18)
.modelqx NPN(Is=800.0E-18
Bf=7.000E3)
.ends
```

Figure 58. TLE2027 Macromodel Subcircuit

```
.subckt TLE2037 1 2 3 4 5
*
c1      11  12  4.003E-12
c2      6   7   7.500E-12
dc      5  53  dz
de      54  5   dz
dlp     90  91  dz
dln     92  90  dx
dp      4   3   dz
egnd    99   0  poly(2) (3,0)
(4,0) 0 .5 .5
fb      7   99  poly(5) vb vc
ve vip vln 0 923.4E6 A800E6
800E6 800E6 A800E6
ga      6   0  11  12 2.121E-3
gcm     0   6  10  99 597.7E-12
iee     10  4   dc 56.26E-6
hlim    90  0   vlim 1K
ql      11  2   13 qx
q2      12  1   14 qz
r2      6   9   100.0E3
rc1     3   11  471.5
rc2     3   12  471.5
re1     13  10  A448
re2     14  10  A448
ree     10  99  3.555E6
ro1     8   5   25
ro2     7   99  25
rp      3   4   8.013E3
vb      9   0   dc 0
vc      3   53  dc 2.400
ve      54  4   dc 2.100
vlim    7   8   dc 0
vlp     91  0   dc 40
vln     0   92  dc 40
.model  dxD(Is=800.0E-18)
.model  qxNPN(Is=800.0E-18
Bf=7.031E3)
.ends
```

Figure 59. TLE2037 Macromodel Subcircuit

PACKAGING INFORMATION

Orderable Device	Status ⁽¹⁾	Package Type	Package Drawing	Pins	Package Qty	Eco Plan ⁽²⁾	Lead/Ball Finish	MSL Peak Temp ⁽³⁾
5962-9089601M2A	ACTIVE	LCCC	FK	20	1	None	POST-PLATE	Level-NC-NC-NC
5962-9089601MPA	ACTIVE	CDIP	JG	8	1	None	A42 SNPB	Level-NC-NC-NC
5962-9089602MPA	OBSOLETE	CDIP	JG	8		None	Call TI	Call TI
5962-9089603Q2A	ACTIVE	LCCC	FK	20	1	None	POST-PLATE	Level-NC-NC-NC
5962-9089603QPA	ACTIVE	CDIP	JG	8	1	None	A42 SNPB	Level-NC-NC-NC
TLE2027ACD	OBSOLETE	SOIC	D	8		None	Call TI	Call TI
TLE2027ACP	OBSOLETE	PDIP	P	8		Pb-Free (RoHS)	CU NIPDAU	Level-NC-NC-NC
TLE2027AID	OBSOLETE	SOIC	D	8		Pb-Free (RoHS)	CU NIPDAU	Level-2-260C-1YEAR/ Level-1-220C-UNLIM
TLE2027AIP	OBSOLETE	PDIP	P	8		Pb-Free (RoHS)	CU NIPDAU	Level-NC-NC-NC
TLE2027AMD	ACTIVE	SOIC	D	8	75	None	CU NIPDAU	Level-1-220C-UNLIM
TLE2027AMFKB	ACTIVE	LCCC	FK	20	1	None	POST-PLATE	Level-NC-NC-NC
TLE2027AMJG	ACTIVE	CDIP	JG	8	1	None	A42 SNPB	Level-NC-NC-NC
TLE2027AMJGB	ACTIVE	CDIP	JG	8	1	None	A42 SNPB	Level-NC-NC-NC
TLE2027CD	ACTIVE	SOIC	D	8	75	None	CU NIPDAU	Level-1-220C-UNLIM
TLE2027CDR	ACTIVE	SOIC	D	8	2500	None	CU NIPDAU	Level-1-220C-UNLIM
TLE2027CP	OBSOLETE	PDIP	P	8		None	Call TI	Call TI
TLE2027ID	ACTIVE	SOIC	D	8	75	Pb-Free (RoHS)	CU NIPDAU	Level-2-260C-1YEAR/ Level-1-220C-UNLIM
TLE2027IDR	ACTIVE	SOIC	D	8	2500	Pb-Free (RoHS)	CU NIPDAU	Level-2-260C-1YEAR/ Level-1-220C-UNLIM
TLE2027IP	OBSOLETE	PDIP	P	8		None	Call TI	Call TI
TLE2027MD	ACTIVE	SOIC	D	8	75	None	CU NIPDAU	Level-1-220C-UNLIM
TLE2027MFKB	ACTIVE	LCCC	FK	20	1	None	POST-PLATE	Level-NC-NC-NC
TLE2027MJG	ACTIVE	CDIP	JG	8	1	None	A42 SNPB	Level-NC-NC-NC
TLE2027MJGB	ACTIVE	CDIP	JG	8	1	None	A42 SNPB	Level-NC-NC-NC
TLE2037ACD	OBSOLETE	SOIC	D	8		None	Call TI	Call TI
TLE2037ACP	OBSOLETE	PDIP	P	8		None	Call TI	Call TI
TLE2037AID	OBSOLETE	SOIC	D	8		None	Call TI	Call TI
TLE2037AIP	OBSOLETE	PDIP	P	8		Pb-Free (RoHS)	CU NIPDAU	Level-NC-NC-NC
TLE2037AMD	ACTIVE	SOIC	D	8	75	None	CU NIPDAU	Level-1-220C-UNLIM
TLE2037AMJGB	OBSOLETE	CDIP	JG	8		None	Call TI	Call TI
TLE2037CD	ACTIVE	SOIC	D	8	75	Pb-Free (RoHS)	CU NIPDAU	Level-2-260C-1YEAR/ Level-1-220C-UNLIM
TLE2037CDR	ACTIVE	SOIC	D	8	2500	Pb-Free (RoHS)	CU NIPDAU	Level-2-260C-1YEAR/ Level-1-220C-UNLIM
TLE2037CP	OBSOLETE	PDIP	P	8		None	Call TI	Call TI
TLE2037ID	ACTIVE	SOIC	D	8	75	Pb-Free (RoHS)	CU NIPDAU	Level-2-260C-1YEAR/ Level-1-220C-UNLIM
TLE2037IDR	ACTIVE	SOIC	D	8	2500	Pb-Free (RoHS)	CU NIPDAU	Level-2-260C-1YEAR/ Level-1-220C-UNLIM
TLE2037IP	OBSOLETE	PDIP	P	8		None	Call TI	Call TI

Orderable Device	Status ⁽¹⁾	Package Type	Package Drawing	Pins	Package Qty	Eco Plan ⁽²⁾	Lead/Ball Finish	MSL Peak Temp ⁽³⁾
TLE2037MD	ACTIVE	SOIC	D	8	75	None	CU NIPDAU	Level-1-220C-UNLIM
TLE2037MFKB	OBSOLETE	LCCC	FK	20		None	Call TI	Call TI
TLE2037MJGB	OBSOLETE	CDIP	JG	8		None	Call TI	Call TI

⁽¹⁾ The marketing status values are defined as follows:

ACTIVE: Product device recommended for new designs.

LIFEBUY: TI has announced that the device will be discontinued, and a lifetime-buy period is in effect.

NRND: Not recommended for new designs. Device is in production to support existing customers, but TI does not recommend using this part in a new design.

PREVIEW: Device has been announced but is not in production. Samples may or may not be available.

OBSOLETE: TI has discontinued the production of the device.

⁽²⁾ Eco Plan - May not be currently available - please check <http://www.ti.com/productcontent> for the latest availability information and additional product content details.

None: Not yet available Lead (Pb-Free).

Pb-Free (RoHS): TI's terms "Lead-Free" or "Pb-Free" mean semiconductor products that are compatible with the current RoHS requirements for all 6 substances, including the requirement that lead not exceed 0.1% by weight in homogeneous materials. Where designed to be soldered at high temperatures, TI Pb-Free products are suitable for use in specified lead-free processes.

Green (RoHS & no Sb/Br): TI defines "Green" to mean "Pb-Free" and in addition, uses package materials that do not contain halogens, including bromine (Br) or antimony (Sb) above 0.1% of total product weight.

⁽³⁾ MSL, Peak Temp. -- The Moisture Sensitivity Level rating according to the JEDEC industry standard classifications, and peak solder temperature.

Important Information and Disclaimer: The information provided on this page represents TI's knowledge and belief as of the date that it is provided. TI bases its knowledge and belief on information provided by third parties, and makes no representation or warranty as to the accuracy of such information. Efforts are underway to better integrate information from third parties. TI has taken and continues to take reasonable steps to provide representative and accurate information but may not have conducted destructive testing or chemical analysis on incoming materials and chemicals. TI and TI suppliers consider certain information to be proprietary, and thus CAS numbers and other limited information may not be available for release.

In no event shall TI's liability arising out of such information exceed the total purchase price of the TI part(s) at issue in this document sold by TI to Customer on an annual basis.

IMPORTANT NOTICE

Texas Instruments Incorporated and its subsidiaries (TI) reserve the right to make corrections, modifications, enhancements, improvements, and other changes to its products and services at any time and to discontinue any product or service without notice. Customers should obtain the latest relevant information before placing orders and should verify that such information is current and complete. All products are sold subject to TI's terms and conditions of sale supplied at the time of order acknowledgment.

TI warrants performance of its hardware products to the specifications applicable at the time of sale in accordance with TI's standard warranty. Testing and other quality control techniques are used to the extent TI deems necessary to support this warranty. Except where mandated by government requirements, testing of all parameters of each product is not necessarily performed.

TI assumes no liability for applications assistance or customer product design. Customers are responsible for their products and applications using TI components. To minimize the risks associated with customer products and applications, customers should provide adequate design and operating safeguards.

TI does not warrant or represent that any license, either express or implied, is granted under any TI patent right, copyright, mask work right, or other TI intellectual property right relating to any combination, machine, or process in which TI products or services are used. Information published by TI regarding third-party products or services does not constitute a license from TI to use such products or services or a warranty or endorsement thereof. Use of such information may require a license from a third party under the patents or other intellectual property of the third party, or a license from TI under the patents or other intellectual property of TI.

Reproduction of information in TI data books or data sheets is permissible only if reproduction is without alteration and is accompanied by all associated warranties, conditions, limitations, and notices. Reproduction of this information with alteration is an unfair and deceptive business practice. TI is not responsible or liable for such altered documentation.

Resale of TI products or services with statements different from or beyond the parameters stated by TI for that product or service voids all express and any implied warranties for the associated TI product or service and is an unfair and deceptive business practice. TI is not responsible or liable for any such statements.

Following are URLs where you can obtain information on other Texas Instruments products and application solutions:

Products		Applications	
Amplifiers	amplifier.ti.com	Audio	www.ti.com/audio
Data Converters	dataconverter.ti.com	Automotive	www.ti.com/automotive
DSP	dsp.ti.com	Broadband	www.ti.com/broadband
Interface	interface.ti.com	Digital Control	www.ti.com/digitalcontrol
Logic	logic.ti.com	Military	www.ti.com/military
Power Mgmt	power.ti.com	Optical Networking	www.ti.com/opticalnetwork
Microcontrollers	microcontroller.ti.com	Security	www.ti.com/security
		Telephony	www.ti.com/telephony
		Video & Imaging	www.ti.com/video
		Wireless	www.ti.com/wireless

Mailing Address: Texas Instruments
Post Office Box 655303 Dallas, Texas 75265