

# TLE2161, TLE2161A, TLE2161B EXCALIBUR JFET-INPUT HIGH-OUTPUT-DRIVE μPOWER OPERATIONAL AMPLIFIERS

SLOS049D – NOVEMBER 1989 – REVISED MAY 1996

- **Excellent Output Drive Capability**  
 $V_O = \pm 2.5 \text{ V Min at } R_L = 100 \ \Omega,$   
 $V_{CC\pm} = \pm 5 \text{ V}$   
 $V_O = \pm 12.5 \text{ V Min at } R_L = 600 \ \Omega,$   
 $V_{CC\pm} = \pm 15 \text{ V}$
- **Low Supply Current . . . 280 μA Typ**
- **Decompensated for High Slew Rate and Gain-Bandwidth Product**  
 $A_{VD} = 0.5 \text{ Min}$   
**Slew Rate = 10 V/μs Typ**  
**Gain-Bandwidth Product = 6.5 MHz Typ**

- **Wide Operating Supply Voltage Range**  
 $V_{CC\pm} = \pm 3.5 \text{ V to } \pm 18 \text{ V}$
- **High Open-Loop Gain . . . 280 V/mV Typ**
- **Low Offset Voltage . . . 500 μV Max**
- **Low Offset Voltage Drift With Time**  
**0.04 μV/Month Typ**
- **Low Input Bias Current . . . 5 pA Typ**

## description

The TLE2161, TLE2161A, and TLE2161B are JFET-input, low-power, precision operational amplifiers manufactured using the Texas Instruments Excalibur process. Decompensated for stability with a minimum closed-loop gain of 5, these devices combine outstanding output drive capability with low power consumption, excellent dc precision, and high gain-bandwidth product.

In addition to maintaining the traditional JFET advantages of fast slew rates and low input bias and offset currents, the Excalibur process offers outstanding parametric stability over time and temperature. This results in a device that remains precise even with changes in temperature and over years of use.

**MAXIMUM PEAK-TO-PEAK OUTPUT VOLTAGE  
vs  
LOAD RESISTANCE**

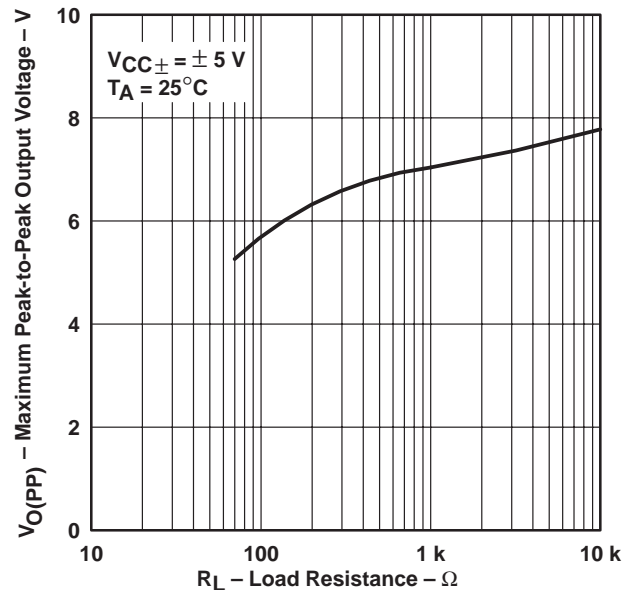

## AVAILABLE OPTIONS

$T_A$	$V_{IOmax}$ AT 25°C	PACKAGE			
		SMALL OUTLINE (D)	CHIP CARRIER (FK)	CERAMIC DIP (JG)	PLASTIC DIP (P)
0°C to 70°C	500 μV 1.5 mV 3 mV	— TLE2161ACD TLE2161CD	— — —	— — —	TLE2161BCP TLE2161ACP TLE2161CP
-40°C to 85°C	500 μV 1.5 mV 3 mV	— TLE2161AID TLE2161ID	— — —	— — —	TLE2161BIP TLE2161AIP TLE2161IP
-55°C to 125°C	500 μV 1.5 mV 3 mV	— TLE2161AMD TLE2161MD	— TLE2161AMFK TLE2161MFK	TLE2161BMJG TLE2161AMJG TLE2161MJG	TLE2161BMP TLE2161AMP TLE2161MP

The D packages are available taped and reeled. Add R suffix to device type (e.g., TLE2161ACDR).



Please be aware that an important notice concerning availability, standard warranty, and use in critical applications of Texas Instruments semiconductor products and disclaimers thereto appears at the end of this data sheet.

PRODUCTION DATA information is current as of publication date. Products conform to specifications per the terms of Texas Instruments standard warranty. Production processing does not necessarily include testing of all parameters.

**TEXAS  
INSTRUMENTS**

POST OFFICE BOX 655303 • DALLAS, TEXAS 75265

Copyright © 1996, Texas Instruments Incorporated

# TLE2161, TLE2161A, TLE2161B

## EXCALIBUR JFET-INPUT HIGH-OUTPUT-DRIVE

### μPOWER OPERATIONAL AMPLIFIERS

SLOS049D – NOVEMBER 1989 – REVISED MAY 1996

#### description (continued)

A variety of available options includes small-outline packages and chip-carrier versions for high-density system applications.

The C-suffix devices are characterized for operation from 0°C to 70°C. The I-suffix devices are characterized for operation from – 40°C to 85°C. The M-suffix devices are characterized for operation over the full military temperature range of – 55°C to 125°C.

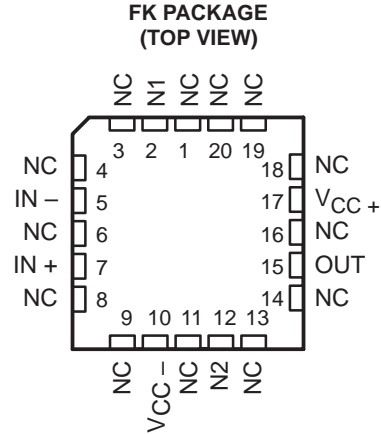
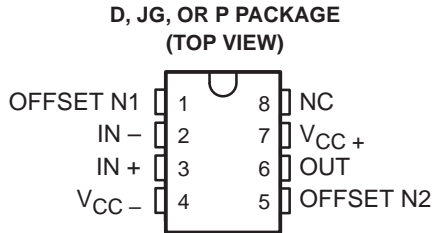

NC – No internal connection

#### equivalent schematic

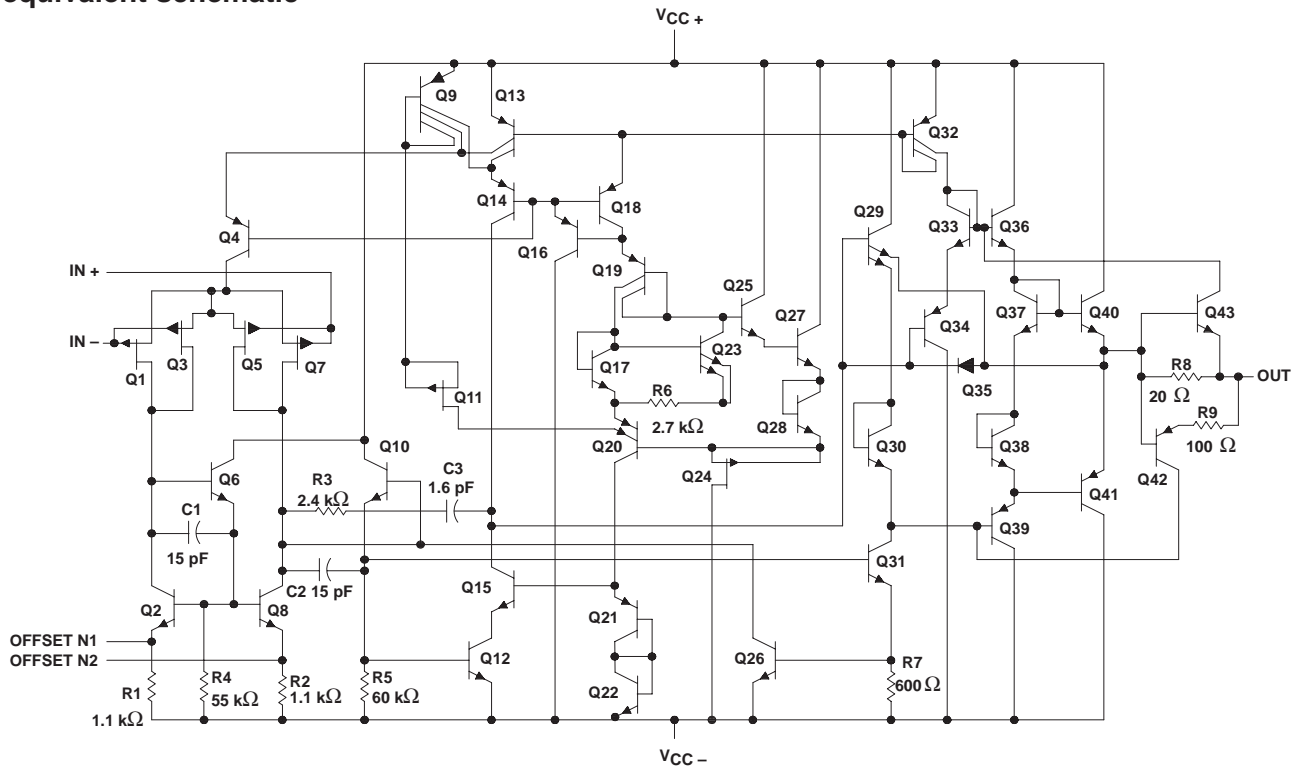

All component values are nominal.

**absolute maximum ratings over operating free-air temperature range (unless otherwise noted)†**

Supply voltage, $V_{CC+}$ (see Note 1)	19 V
Supply voltage, $V_{CC-}$	– 19 V
Differential input voltage, $V_{ID}$ (see Note 2)	$\pm 38$ V
Input voltage range, $V_I$ (any input)	$V_{CC\pm}$
Input current, $I_I$ (each input)	$\pm 1$ mA
Output current, $I_O$	$\pm 80$ mA
Total current into $V_{CC+}$	80 mA
Total current out of $V_{CC-}$	80 mA
Duration of short-circuit current at (or below) 25°C (see Note 3)	unlimited
Continuous total power dissipation	See Dissipation Rating Table
Operating free-air temperature range, $T_A$ : C suffix	0°C to 70°C
I suffix	– 40°C to 85°C
M suffix	– 55°C to 125°C
Storage temperature range, $T_{stg}$	– 65°C to 150°C
Case temperature for 60 seconds: FK package	260°C
Lead temperature 1,6 mm (1/16 inch) from case for 10 seconds: D or P package	260°C
Lead temperature 1,6 mm (1/16 inch) from case for 60seconds: JG package	300°C

† Stresses beyond those listed under “absolute maximum ratings” may cause permanent damage to the device. These are stress ratings only, and functional operation of the device at these or any other conditions beyond those indicated under “recommended operating conditions” is not implied. Exposure to absolute-maximum-rated conditions for extended periods may affect device reliability.

- NOTES:
1. All voltage values, except differential voltages, are with respect to the midpoint between  $V_{CC+}$  and  $V_{CC-}$ .
  2. Differential voltages are at  $IN+$  with respect to  $IN-$ .
  3. The output may be shorted to either supply. Temperature and /or supply voltages must be limited to ensure that the maximum dissipation rating is not exceeded.

**DISSIPATION RATING TABLE**

PACKAGE	$T_A \leq 25^\circ\text{C}$	DERATING FACTOR ABOVE $T_A = 25^\circ\text{C}$	$T_A = 70^\circ\text{C}$	$T_A = 85^\circ\text{C}$	$T_A = 125^\circ\text{C}$
	POWER RATING		POWER RATING	POWER RATING	POWER RATING
D	725 mW	5.8 mW/°C	464 mW	377 mW	145 mW
FK	1375 mW	11.0 mW/°C	880 mW	715 mW	275 mW
JG	1050 mW	8.4 mW/°C	672 mW	546 mW	210 mW
P	1000 mW	8.0 mW/°C	640 mW	520 mW	200 mW

**recommended operating conditions**

	C SUFFIX		I SUFFIX		M SUFFIX		UNIT
	MIN	MAX	MIN	MAX	MIN	MAX	
Supply voltage, $V_{CC\pm}$	$\pm 3.5$	$\pm 18$	$\pm 3.5$	$\pm 18$	$+3.5$	$\pm 18$	V
Common-mode input voltage, $V_{IC}$	$V_{CC\pm} = \pm 5$ V		–1.6	4	–1.6	4	V
	$V_{CC\pm} = \pm 15$ V		–11	13	–11	13	
Operating free-air temperature, $T_A$	0	70	–40	85	–55	125	°C

# TLE2161, TLE2161A, TLE2161B

## EXCALIBUR JFET-INPUT HIGH-OUTPUT-DRIVE

### μPOWER OPERATIONAL AMPLIFIERS

SLOS049D – NOVEMBER 1989 – REVISED MAY 1996

electrical characteristics at specified free-air temperature,  $V_{CC} \pm \pm 5\text{ V}$  (unless otherwise noted)

PARAMETER		TEST CONDITIONS	$T_A$ †	TLE2161C, TLE2161AC TLE2161BC			UNIT	
				MIN	TYP	MAX		
$V_{IO}$ Input offset voltage	TLE2161C	$V_{IC} = 0, R_S = 50\ \Omega$	25°C	0.8	3.1	mV		
			Full range	4				
			25°C	0.6	2.6			
	TLE2161AC		Full range	3.5				
			25°C	0.5	1.9			
			Full range	2.4				
	$\alpha_{VIO}$ Temperature coefficient of input offset voltage		Input offset voltage long-term drift (see Note 4)	Full range	6		$\mu\text{V}/^\circ\text{C}$	
				25°C	0.04		$\mu\text{V}/\text{mo}$	
	$I_{IO}$ Input offset current			25°C	1		pA	
Full range		0.8		nA				
$I_{IB}$ Input bias current		25°C	3		pA			
		Full range	2		nA			
$V_{ICR}$ Common-mode input voltage range		25°C	-1.6 to 4	-2 to 6	V			
		Full range	-1.6 to 4		V			
$V_{OM+}$ Maximum positive peak output voltage swing	$R_L = 10\ \text{k}\Omega$	25°C	3.5	3.7	V			
		Full range	3.3					
	$R_L = 100\ \Omega$	25°C	2.5	3.1				
		Full range	2					
$V_{OM-}$ Maximum negative peak output voltage swing	$R_L = 10\ \text{k}\Omega$	25°C	-3.7	-3.9	V			
		Full range	-3.3					
	$R_L = 100\ \Omega$	25°C	-2.5	-2.7				
		Full range	-2					
$A_{VD}$ Large-signal differential voltage amplification	$V_O = \pm 2.8\ \text{V}, R_L = 10\ \text{k}\Omega$	25°C	15	80	V/mV			
		Full range	2					
	$V_O = 0\ \text{to}\ 2\ \text{V}, R_L = 100\ \Omega$	25°C	0.75	45				
		Full range	0.5					
	$V_O = 0\ \text{to}\ -2\ \text{V}, R_L = 100\ \Omega$	25°C	0.5	3				
		Full range	0.25					
$r_i$ Input resistance		25°C	$10^{12}$		$\Omega$			
$c_i$ Input capacitance		25°C	4		pF			
$z_o$ Open-loop output impedance	$I_O = 0$	25°C	280		$\Omega$			
CMRR Common-mode rejection ratio	$V_{IC} = V_{ICRmin}, R_S = 50\ \Omega$	25°C	65	82	dB			
		Full range	65					
kSVR Supply-voltage rejection ratio ( $\Delta V_{CC\pm} / \Delta V_{IO}$ )	$V_{CC\pm} = \pm 5\ \text{V}\ \text{to}\ \pm 15\ \text{V}, R_S = 50\ \Omega$	25°C	75	93	dB			
		Full range	75					
$I_{CC}$ Supply current	$V_O = 0, \text{ No load}$	25°C	280	325	$\mu\text{A}$			
		Full range	350					
$\Delta I_{CC}$ Supply-current change over operating temperature range		Full range	29		$\mu\text{A}$			

† Full range is 0°C to 70°C.

NOTE 4: Typical values are based on the input offset voltage shift observed through 168 hours of operating life test at  $T_A = 150^\circ\text{C}$  extrapolated to  $T_A = 25^\circ\text{C}$  using the Arrhenius equation and assuming an activation energy of 0.96 eV.



TLE2161, TLE2161A, TLE2161B  
EXCALIBUR JFET-INPUT HIGH-OUTPUT-DRIVE  
 $\mu$ POWER OPERATIONAL AMPLIFIERS  
SLOS049D – NOVEMBER 1989 – REVISED MAY 1996

operating characteristics at specified free-air temperature,  $V_{CC} \pm = \pm 5$  V (unless otherwise noted)

PARAMETER	TEST CONDITIONS	$T_A$ †	TLE2161C, TLE2161AC TLE2161BC			UNIT
			MIN	TYP	MAX	
SR Slew rate (see Figure 1)	$A_{VD} = 5, R_L = 10 \text{ k}\Omega, C_L = 100 \text{ pF}$	25°C	7	10		V/ $\mu$ s
		Full range	5			
$V_n$ Equivalent input noise voltage (see Figure 2)	$R_S = 20 \Omega, f = 10 \text{ Hz}$	25°C		59	100	nV/ $\sqrt{\text{Hz}}$
	$R_S = 20 \Omega, f = 1 \text{ kHz}$			43	60	
$V_n(\text{PP})$ Peak-to-peak equivalent input noise voltage	$f = 0.1 \text{ Hz to } 10 \text{ Hz}$	25°C		1.1		$\mu$ V
$I_n$ Equivalent input noise current	$f = 1 \text{ kHz}$	25°C		1		fA/ $\sqrt{\text{Hz}}$
THD Total harmonic distortion	$V_O(\text{PP}) = 2 \text{ V}, A_{VD} = 5, f = 10 \text{ kHz}, R_L = 10 \text{ k}\Omega$	25°C		0.025%		
Gain-bandwidth product (see Figure 3)	$f = 100 \text{ kHz}, R_L = 10 \text{ k}\Omega, C_L = 100 \text{ pF}$	25°C		5.8		MHz
	$f = 100 \text{ kHz}, R_L = 100 \text{ k}\Omega, C_L = 100 \text{ pF}$			4.3		
$t_s$ Settling time	$\epsilon = 0.1\%$	25°C		5		$\mu$ s
	$\epsilon = 0.01\%$			10		
$B_{OM}$ Maximum output-swing bandwidth	$A_{VD} = 5, R_L = 10 \text{ k}\Omega$	25°C		420		kHz
$\phi_m$ Phase margin (see Figure 3)	$A_{VD} = 5, R_L = 10 \text{ k}\Omega, C_L = 100 \text{ pF}$	25°C		70°		
	$A_{VD} = 5, R_L = 100 \Omega, C_L = 100 \text{ pF}$			84°		

† Full range is 0°C to 70°C.

# TLE2161, TLE2161A, TLE2161B

## EXCALIBUR JFET-INPUT HIGH-OUTPUT-DRIVE

### μPOWER OPERATIONAL AMPLIFIERS

SLOS049D – NOVEMBER 1989 – REVISED MAY 1996

electrical characteristics at specified free-air temperature,  $V_{CC} \pm = \pm 15\text{ V}$  (unless otherwise noted)

PARAMETER		TEST CONDITIONS	$T_A$ †	TLE2161C, TLE2161AC TLE2161BC			UNIT
				MIN	TYP	MAX	
$V_{IO}$	Input offset voltage	$V_{IC} = 0,$ $R_S = 50\ \Omega$	25°C	0.6	3	mV	
			Full range	3.9			
			25°C	0.5	1.5		
			Full range	2.5			
			25°C	0.3	0.5		
			Full range	1			
$\alpha_{V_{IO}}$	Temperature coefficient of input offset voltage	$V_{IC} = 0,$ $R_S = 50\ \Omega$	Full range	6		$\mu\text{V}/^\circ\text{C}$	
	Input offset voltage long-term drift (see Note 4)		25°C	0.04		$\mu\text{V}/\text{mo}$	
$I_{IO}$	Input offset current		25°C	2		pA	
			Full range	1		nA	
$I_{IB}$	Input bias current		25°C	4		pA	
			Full range	3		nA	
$V_{ICR}$	Common-mode input voltage range		25°C	-11 to 13	-12 to 16	V	
			Full range	-11 to 13		V	
$V_{OM+}$	Maximum positive peak output voltage swing	$R_L = 10\ \text{k}\Omega$	25°C	13.2	13.7	V	
			Full range	13			
		$R_L = 600\ \Omega$	25°C	12.5	13.2		
			Full range	12			
$V_{OM-}$	Maximum negative peak output voltage swing	$R_L = 10\ \text{k}\Omega$	25°C	-13.2	-13.7	V	
			Full range	-13			
		$R_L = 600\ \Omega$	25°C	-12.5	-13		
			Full range	-12			
$A_{VD}$	Large-signal differential voltage amplification	$V_O = \pm 10\ \text{V},$ $R_L = 10\ \text{k}\Omega$	25°C	30	230	V/mV	
			Full range	20			
		$V_O = 0\ \text{to}\ 8\ \text{V},$ $R_L = 600\ \Omega$	25°C	25	100		
			Full range	10			
		$V_O = 0\ \text{to}\ -8\ \text{V},$ $R_L = 600\ \Omega$	25°C	3	25		
			Full range	1			
$r_i$	Input resistance		25°C	$10^{12}$		$\Omega$	
$c_i$	Input capacitance		25°C	4		pF	
$z_o$	Open-loop output impedance	$I_O = 0$	25°C	280		$\Omega$	
CMRR	Common-mode rejection ratio	$V_{IC} = V_{ICRmin},$ $R_S = 50\ \Omega$	25°C	72	90	dB	
			Full range	70			
$k_{SVR}$	Supply-voltage rejection ratio ( $\Delta V_{CC\pm} / \Delta V_{IO}$ )	$V_{CC\pm} = \pm 5\ \text{V}\ \text{to}\ \pm 15\ \text{V},$ $R_S = 50\ \Omega$	25°C	75	93	dB	
			Full range	75			
$I_{CC}$	Supply current	$V_O = 0,$ No load	25°C	290	350	$\mu\text{A}$	
			Full range	375			
$\Delta I_{CC}$	Supply-current change over operating temperature range		Full range	34		$\mu\text{A}$	

† Full range is 0°C to 70°C.

NOTE 4: Typical values are based on the input offset voltage shift observed through 168 hours of operating life test at  $T_A = 150^\circ\text{C}$  extrapolated to  $T_A = 25^\circ\text{C}$  using the Arrhenius equation and assuming an activation energy of 0.96 eV.



TLE2161, TLE2161A, TLE2161B  
EXCALIBUR JFET-INPUT HIGH-OUTPUT-DRIVE  
 $\mu$ POWER OPERATIONAL AMPLIFIERS  
SLOS049D – NOVEMBER 1989 – REVISED MAY 1996

operating characteristics at specified free-air temperature,  $V_{CC\pm} = \pm 15$  V (unless otherwise noted)

PARAMETER	TEST CONDITIONS	$T_A$ †	TLE2161C, TLE2161AC TLE2161BC			UNIT
			MIN	TYP	MAX	
SR Slew rate (see Figure 1)	$A_{VD} = 5$ , $R_L = 10$ k $\Omega$ , $C_L = 100$ pF	25°C	7	10		V/ $\mu$ s
		Full range	5			
$V_n$ Equivalent input noise voltage (see Figure 2)	$R_S = 20$ $\Omega$ , $f = 10$ Hz	25°C		70	100	nV/ $\sqrt{\text{Hz}}$
	$R_S = 20$ $\Omega$ , $f = 1$ kHz			40	60	
$V_{n(PP)}$ Peak-to-peak equivalent input noise voltage	$f = 0.1$ Hz to 10 Hz	25°C		1.1		$\mu$ V
$I_n$ Equivalent input noise current	$f = 1$ kHz	25°C		1.1		fA/ $\sqrt{\text{Hz}}$
THD Total harmonic distortion	$V_{O(PP)} = 2$ V, $A_{VD} = 5$ , $f = 10$ kHz, $R_L = 10$ k $\Omega$	25°C		0.025%		
Gain-bandwidth product (see Figure 3)	$f = 100$ kHz, $R_L = 10$ k $\Omega$ , $C_L = 100$ pF	25°C		6.4		MHz
	$f = 100$ kHz, $R_L = 600$ $\Omega$ , $C_L = 100$ pF			5.6		
$t_s$ Settling time	$\epsilon = 0.1\%$	25°C		5		$\mu$ s
	$\epsilon = 0.01\%$			10		
BOM Maximum output-swing bandwidth	$A_{VD} = 5$ , $R_L = 10$ k $\Omega$	25°C		116		kHz
$\phi_m$ Phase margin (see Figure 3)	$A_{VD} = 5$ , $R_L = 10$ k $\Omega$ , $C_L = 100$ pF	25°C		72°		
	$A_{VD} = 5$ , $R_L = 600$ $\Omega$ , $C_L = 100$ pF			78°		

† Full range is 0°C to 70°C.

**TLE2161, TLE2161A, TLE2161B**  
**EXCALIBUR JFET-INPUT HIGH-OUTPUT-DRIVE**  
**μPOWER OPERATIONAL AMPLIFIERS**

SLOS049D – NOVEMBER 1989 – REVISED MAY 1996

**electrical characteristics at specified free-air temperature,  $V_{CC} \pm \pm 5\text{ V}$  (unless otherwise noted)**

PARAMETER		TEST CONDITIONS	$T_A$ †	TLE2161I, TLE2161AI TLE2161BI			UNIT
				MIN	TYP	MAX	
$V_{IO}$	Input offset voltage	$V_{IC} = 0, R_S = 50\ \Omega$	25°C	0.8	3.1	mV	
			Full range	4.4			
			25°C	0.6	2.6		
			Full range	3.9			
			25°C	0.5	1.9		
			Full range	2.7			
$\alpha_{VIO}$	Temperature coefficient of input offset voltage	$V_{IC} = 0, R_S = 50\ \Omega$	Full range	6		$\mu\text{V}/^\circ\text{C}$	
	Input offset voltage long-term drift (see Note 4)		25°C	0.04		$\mu\text{V}/\text{mo}$	
$I_{IO}$	Input offset current		25°C	1		pA	
			Full range	2		nA	
$I_{IB}$	Input bias current	$V_{IC} = 0, R_S = 50\ \Omega$	25°C	3		pA	
			Full range	4		nA	
$V_{ICR}$	Common-mode input voltage range	$V_{IC} = 0, R_S = 50\ \Omega$	25°C	-1.6 to 4	-2 to 6	V	
			Full range	-1.6 to 4			
$V_{OM+}$	Maximum positive peak output voltage	$R_L = 10\ \text{k}\Omega$	25°C	3.5	3.7	V	
			Full range	3.1			
		$R_L = 100\ \Omega$	25°C	2.5	3.1		
			Full range	2			
$V_{OM-}$	Maximum negative peak output voltage swing	$R_L = 10\ \text{k}\Omega$	25°C	-3.7	-3.9	V	
			Full range	-3.1			
		$R_L = 100\ \Omega$	25°C	-2.5	-2.7		
			Full range	-2			
$A_{VD}$	Large-signal differential voltage amplification	$V_O = \pm 2.8\ \text{V}, R_L = 10\ \text{k}\Omega$	25°C	15	80	V/mV	
			Full range	2			
		$V_O = 0\ \text{to}\ 2\ \text{V}, R_L = 100\ \Omega$	25°C	0.75	45		
			Full range	0.5			
		$V_O = 0\ \text{to}\ -2\ \text{V}, R_L = 100\ \Omega$	25°C	0.5	3		
			Full range	0.25			
$r_i$	Input resistance		25°C	10 <sup>12</sup>		$\Omega$	
$c_i$	Input capacitance		25°C	4		pF	
$z_o$	Open-loop output impedance	$I_O = 0$	25°C	280		$\Omega$	
CMRR	Common-mode rejection ratio	$V_{IC} = V_{ICRmin}, R_S = 50\ \Omega$	25°C	65	82	dB	
			Full range	65			
kSVR	Supply-voltage rejection ratio ( $\Delta V_{CC\pm} / \Delta V_{IO}$ )	$V_{CC\pm} = \pm 5\ \text{V to } \pm 15\ \text{V}, R_S = 50\ \Omega$	25°C	75	93	dB	
			Full range	65			
$I_{CC}$	Supply current	$V_O = 0, \text{ No load}$	25°C	280	325	$\mu\text{A}$	
			Full range	350			
$\Delta I_{CC}$	Supply-current change over operating temperature range		Full range	29		$\mu\text{A}$	

† Full range is -40°C to 85°C.

NOTE 4: Typical values are based on the input offset voltage shift observed through 168 hours of operating life test at  $T_A = 150^\circ\text{C}$  extrapolated to  $T_A = 25^\circ\text{C}$  using the Arrhenius equation and assuming an activation energy of 0.96 eV.



**TLE2161, TLE2161A, TLE2161B**  
**EXCALIBUR JFET-INPUT HIGH-OUTPUT-DRIVE**  
**μPOWER OPERATIONAL AMPLIFIERS**  
SLOS049D – NOVEMBER 1989 – REVISED MAY 1996

**operating characteristics at specified free-air temperature,  $V_{CC} \pm = \pm 5\text{ V}$  (unless otherwise noted)**

PARAMETER		TEST CONDITIONS	$T_A$ †	TLE2161, TLE2161A TLE2161BI			UNIT
				MIN	TYP	MAX	
SR	Slew rate (see Figure 1)	$A_{VD} = 5$ , $R_L = 10\text{ k}\Omega$ , $C_L = 100\text{ pF}$	25°C	7	10		V/ $\mu\text{s}$
			Full range	5			
$V_n$	Equivalent input noise voltage (see Figure 2)	$R_S = 20\ \Omega$ , $f = 10\text{ Hz}$	25°C		59	100	nV/ $\sqrt{\text{Hz}}$
		$R_S = 20\ \Omega$ , $f = 1\text{ kHz}$			43	60	
$V_{n(PP)}$	Peak-to-peak equivalent input noise voltage	$f = 0.1\text{ Hz to }10\text{ Hz}$	25°C		1.1		$\mu\text{V}$
$I_n$	Equivalent input noise current	$f = 1\text{ kHz}$	25°C		1		fA/ $\sqrt{\text{Hz}}$
THD	Total harmonic distortion	$V_{O(PP)} = 2\text{ V}$ , $R_L = 10\text{ k}\Omega$ , $A_{VD} = 5$ , $f = 10\text{ kHz}$	25°C		0.025%		
	Gain-bandwidth product (see Figure 3)	$f = 100\text{ kHz}$ , $R_L = 10\text{ k}\Omega$ , $C_L = 100\text{ pF}$	25°C		5.8		MHz
		$f = 100\text{ kHz}$ , $R_L = 100\ \Omega$ , $C_L = 100\text{ pF}$			4.3		
$t_s$	Settling time	$\epsilon = 0.1\%$	25°C		5		$\mu\text{s}$
		$\epsilon = 0.01\%$			10		
$B_{OM}$	Maximum output-swing bandwidth	$A_{VD} = 5$ , $R_L = 10\text{ k}\Omega$	25°C		420		kHz
$\phi_m$	Phase margin (see Figure 3)	$A_{VD} = 5$ , $R_L = 10\text{ k}\Omega$ , $C_L = 100\text{ pF}$	25°C		70°		
		$A_{VD} = 5$ , $R_L = 100\ \Omega$ , $C_L = 100\text{ pF}$			84°		

† Full range is – 40°C to 85°C.

**TLE2161, TLE2161A, TLE2161B**  
**EXCALIBUR JFET-INPUT HIGH-OUTPUT-DRIVE**  
**μPOWER OPERATIONAL AMPLIFIERS**

SLOS049D – NOVEMBER 1989 – REVISED MAY 1996

**electrical characteristics at specified free-air temperature,  $V_{CC\pm} = \pm 15\text{ V}$  (unless otherwise noted)**

PARAMETER		TEST CONDITIONS	$T_A^\dagger$	TLE2161, TLE2161A TLE2161B			UNIT		
				MIN	TYP	MAX			
$V_{IO}$	Input offset voltage	$V_{IC} = 0, \quad R_S = 50\ \Omega$	25°C	0.6	3	mV			
			Full range	4.3					
			25°C	0.5	1.5				
			Full range	2.9					
			25°C	0.3	0.5				
			Full range	1.3					
			$\alpha_{VIO}$	Temperature coefficient of input offset voltage	Full range		6		$\mu\text{V}/^\circ\text{C}$
				Input offset voltage long-term drift (see Note 4)	25°C		0.04		$\mu\text{V}/\text{mo}$
			$I_{IO}$	Input offset current	25°C		2		pA
$I_{IB}$	Input bias current		25°C	4		pA			
			Full range	5		nA			
$V_{ICR}$	Common-mode input voltage range		25°C	-11 to 13	-12 to 16	V			
			Full range	-11 to 13		V			
$V_{OM+}$	Maximum positive peak output voltage swing	$R_L = 10\ \text{k}\Omega$	25°C	13.2	13.7	V			
			Full range	13					
		$R_L = 600\ \Omega$	25°C	12.5	13.2				
			Full range	12					
$V_{OM-}$	Maximum negative peak output voltage swing	$R_L = 10\ \text{k}\Omega$	25°C	-13.2	-13.7	V			
			Full range	-13					
		$R_L = 600\ \Omega$	25°C	-12.5	-13				
			Full range	-12					
$A_{VD}$	Large-signal differential voltage amplification	$V_0 = \pm 10\ \text{V}, \quad R_L = 10\ \text{k}\Omega$	25°C	30	230	V/mV			
			Full range	20					
		$V_0 = 0\ \text{to}\ 8\ \text{V}, \quad R_L = 600\ \Omega$	25°C	25	100				
			Full range	10					
		$V_0 = 0\ \text{to}\ -8\ \text{V}, \quad R_L = 600\ \Omega$	25°C	3	25				
			Full range	1					
$r_i$	Input resistance		25°C	$10^{12}$		$\Omega$			
$c_i$	Input capacitance		25°C	4		pF			
$z_o$	Open-loop output impedance	$I_O = 0$	25°C	280		$\Omega$			
CMRR	Common-mode rejection ratio	$V_{IC} = V_{ICRmin}, \quad R_S = 50\ \Omega$	25°C	72	90	dB			
			Full range	65					
$k_{SVR}$	Supply-voltage rejection ratio ( $\Delta V_{CC\pm} / \Delta V_{IO}$ )	$V_{CC\pm} = \pm 5\ \text{V}\ \text{to}\ \pm 15\ \text{V}, \quad R_S = 50\ \Omega$	25°C	75	93	dB			
			Full range	65					
$I_{CC}$	Supply current	$V_0 = 0, \quad \text{No load}$	25°C	290	350	$\mu\text{A}$			
			Full range	375					
$\Delta I_{CC}$	Supply-current change over operating temperature range		Full range	34		$\mu\text{A}$			

$^\dagger$  Full range is  $-40^\circ\text{C}$  to  $85^\circ\text{C}$ .

NOTE 4: Typical values are based on the input offset voltage shift observed through 168 hours of operating life test at  $T_A = 150^\circ\text{C}$  extrapolated to  $T_A = 25^\circ\text{C}$  using the Arrhenius equation and assuming an activation energy of 0.96 eV.



TLE2161, TLE2161A, TLE2161B  
EXCALIBUR JFET-INPUT HIGH-OUTPUT-DRIVE  
 $\mu$ POWER OPERATIONAL AMPLIFIERS  
SLOS049D – NOVEMBER 1989 – REVISED MAY 1996

operating characteristics at specified free-air temperature,  $V_{CC} \pm = \pm 15$  V (unless otherwise noted)

PARAMETER	TEST CONDITIONS	$T_A$ †	TLE2161, TLE2161A TLE2161B			UNIT
			MIN	TYP	MAX	
SR Slew rate (see Figure 1)	$A_{VD} = 5$ , $R_L = 10$ k $\Omega$ , $C_L = 100$ pF	25°C	7	10		V/ $\mu$ s
		Full range	5			
$V_n$ Equivalent input noise voltage (see Figure 2)	$R_S = 20$ $\Omega$ , $f = 10$ Hz	25°C		70	100	nV/ $\sqrt{\text{Hz}}$
	$R_S = 20$ $\Omega$ , $f = 1$ kHz			40	60	
$V_{n(PP)}$ Peak-to-peak equivalent input noise voltage	$f = 0.1$ Hz to 10 Hz	25°C		1.1		$\mu$ V
$I_n$ Equivalent input noise current	$f = 1$ kHz	25°C		1.1		fA/ $\sqrt{\text{Hz}}$
THD Total harmonic distortion	$V_{O(PP)} = 2$ V, $A_{VD} = 5$ , $f = 10$ kHz, $R_L = 10$ k $\Omega$	25°C		0.025%		
Gain-bandwidth product (see Figure 3)	$f = 100$ kHz, $R_L = 10$ k $\Omega$ , $C_L = 100$ pF	25°C		6.4		MHz
	$f = 100$ kHz, $R_L = 600$ $\Omega$ , $C_L = 100$ pF			5.6		
$t_s$ Settling time	$\epsilon = 0.1\%$	25°C		5		$\mu$ s
	$\epsilon = 0.01\%$			10		
$B_{OM}$ Maximum output-swing bandwidth	$A_{VD} = 5$ , $R_L = 10$ k $\Omega$	25°C		116		kHz
$\phi_m$ Phase margin (see Figure 3)	$A_{VD} = 5$ , $R_L = 10$ k $\Omega$ , $C_L = 100$ pF	25°C		72°		
	$A_{VD} = 5$ , $R_L = 600$ $\Omega$ , $C_L = 100$ pF			78°		

† Full range is – 40°C to 85°C.

**TLE2161, TLE2161A, TLE2161B**  
**EXCALIBUR JFET-INPUT HIGH-OUTPUT-DRIVE**  
**μPOWER OPERATIONAL AMPLIFIERS**

SLOS049D – NOVEMBER 1989 – REVISED MAY 1996

**electrical characteristics at specified free-air temperature,  $V_{CC} \pm \pm 5\text{ V}$  (unless otherwise noted)**

PARAMETER		TEST CONDITIONS	$T_A$ †	TLE2161M TLE2161AM TLE2161BM			UNIT	
				MIN	TYP	MAX		
$V_{IO}$	Input offset voltage	$V_{IC} = 0, R_S = 50\ \Omega$	25°C	0.8	3.1	mV		
			Full range	6				
			25°C	0.6	2.6			
			Full range	4.6				
			25°C	0.5	1.9			
			Full range	3.1				
$\alpha_{VIO}$	Temperature coefficient of input offset voltage	$V_{IC} = 0, R_S = 50\ \Omega$	Full range	6		$\mu\text{V}/^\circ\text{C}$		
	Input offset voltage long-term drift (see Note 4)		25°C	0.04		$\mu\text{V}/\text{mo}$		
$I_{IO}$	Input offset current		25°C	1		pA		
			Full range	15		nA		
$I_{IB}$	Input bias current	25°C	3		pA			
		Full range	30		nA			
$V_{ICR}$	Common-mode input voltage range		25°C	-1.6 to 4	-2 to 6	V		
			Full range	-1.6 to 4		V		
$V_{OM+}$	Maximum positive peak output voltage swing	All packages	$R_L = 10\ \text{k}\Omega$	25°C	3.5	3.7	V	
			Full range	3				
		FK and JG packages	$R_L = 600\ \Omega$	25°C	2.5	3.6	V	
			Full range	2				
		D and P packages	$R_L = 100\ \Omega$	25°C	2.5	3.1	V	
			Full range	2				
$V_{OM-}$	Maximum negative peak output voltage swing	All packages	$R_L = 10\ \text{k}\Omega$	25°C	-3.7	-3.9	V	
			Full range	-3				
		FK and JG packages	$R_L = 600\ \Omega$	25°C	-2.5	-3.5	V	
			Full range	-2				
		D and P packages	$R_L = 100\ \Omega$	25°C	-2.5	-2.7	V	
			Full range	-2				
AVD	Large-signal differential voltage amplification	All packages	$V_0 = \pm 2.8\ \text{V}, R_L = 10\ \text{k}\Omega$	25°C	15	80	V/mV	
				Full range	2			
			FK and JG packages	$V_0 = 0\ \text{to}\ 2.5\ \text{V}, R_L = 600\ \Omega$	25°C	1		65
					Full range	0.5		
				$V_0 = 0\ \text{to}\ -2.5\ \text{V}, R_L = 600\ \Omega$	25°C	1		16
					Full range	0.5		
		D and P packages	$V_0 = 0\ \text{to}\ 2\ \text{V}, R_L = 100\ \Omega$	25°C	0.75	45		
				Full range	0.5			
			$V_0 = 0\ \text{to}\ -2\ \text{V}, R_L = 100\ \Omega$	25°C	0.5	3		
				Full range	0.25			

† Full range is -55°C to 125°C.

NOTE 4: Typical values are based on the input offset voltage shift observed through 168 hours of operating life test at  $T_A = 150^\circ\text{C}$  extrapolated to  $T_A = 25^\circ\text{C}$  using the Arrhenius equation and assuming an activation energy of 0.96 eV.



electrical characteristics at specified free-air temperature,  $V_{CC} \pm = \pm 5\text{ V}$  (unless otherwise noted continued)

PARAMETER	TEST CONDITIONS	$T_A$ †	TLE2161M TLE2161AM TLE2161BM			UNIT
			MIN	TYP	MAX	
$r_i$ Input resistance		25°C	10 <sup>12</sup>			Ω
$c_i$ Input capacitance		25°C	4			pF
$z_o$ Open-loop output impedance	$I_O = 0$	25°C	280			Ω
CMRR Common-mode rejection ratio	$V_{IC} = V_{ICRmin}, R_S = 50\ \Omega$	25°C	65	82		dB
		Full range	60			
$k_{SVR}$ Supply-voltage rejection ratio ( $\Delta V_{CC\pm}/\Delta V_{IO}$ )	$V_{CC\pm} = \pm 5\text{ V to } \pm 15\text{ V}, R_S = 50\ \Omega$	25°C	75	93		dB
		Full range	65			
$I_{CC}$ Supply current	$V_O = 0, \text{ No load}$	25°C	280	325		μA
		Full range	350			
$\Delta I_{CC}$ Supply-current change over operating temperature range		Full range	39			μA

† Full range is –55°C to 125°C.

operating characteristics,  $V_{CC} \pm = \pm 5\text{ V}, T_A = 25^\circ\text{C}$

PARAMETER	TEST CONDITIONS	TLE2161M TLE2161AM TLE2161BM			UNIT
		MIN	TYP	MAX	
SR Slew rate (see Figure 1)	$A_{VD} = 5, R_L = 10\text{ k}\Omega, C_L = 100\text{ pF}$	10			V/μs
$V_n$ Equivalent input noise voltage (see Figure 2)	$R_S = 20\ \Omega, f = 10\text{ Hz}$	59			nV/√Hz
	$R_S = 20\ \Omega, f = 1\text{ kHz}$	43			
$V_n(PP)$ Peak-to-peak equivalent input noise voltage	$f = 0.1\text{ Hz to } 10\text{ Hz}$	1.1			μV
$I_n$ Equivalent input noise current	$f = 1\text{ kHz}$	1			fA/√Hz
THD Total harmonic distortion	$A_{VD} = 5, R_L = 10\text{ k}\Omega, V_O(PP) = 2\text{ V}, f = 10\text{ kHz}$	0.025%			
Gain-bandwidth product (see Figure 3)	$f = 100\text{ kHz}, R_L = 10\text{ k}\Omega, C_L = 100\text{ pF}$	5.8			MHz
	$f = 100\text{ kHz}, R_L = 600\text{ k}\Omega, C_L = 100\text{ pF}$	4.3			
$t_s$ Settling time	$\epsilon = 0.1\%$	5			μs
	$\epsilon = 0.01\%$	10			
$B_{OM}$ Maximum output-swing bandwidth	$A_{VD} = 5, R_L = 10\text{ k}\Omega$	420			kHz
$\phi_m$ Phase margin (see Figure 3)	$A_{VD} = 5, R_L = 10\text{ k}\Omega, C_L = 100\text{ pF}$	70°			
	$A_{VD} = 5, R_L = 600\ \Omega, C_L = 100\text{ pF}$	84°			

**TLE2161, TLE2161A, TLE2161B**  
**EXCALIBUR JFET-INPUT HIGH-OUTPUT-DRIVE**  
**μPOWER OPERATIONAL AMPLIFIERS**

SLOS049D – NOVEMBER 1989 – REVISED MAY 1996

**electrical characteristics at specified free-air temperature,  $V_{CC} \pm = \pm 15\text{ V}$  (unless otherwise noted)**

PARAMETER		TEST CONDITIONS	$T_A$ †	TLE2161M TLE2161AM TLE2161BM			UNIT
				MIN	TYP	MAX	
$V_{IO}$	Input offset voltage	$V_{IC} = 0, R_S = 50\ \Omega$	25°C	0.6	3	mV	
			Full range	6			
			25°C	0.5	1.5		
			Full range	3.6			
			25°C	0.3	0.5		
			Full range	1.7			
$\alpha V_{IO}$	Temperature coefficient of input offset voltage	$V_{IC} = 0, R_S = 50\ \Omega$	Full range	6		$\mu\text{V}/^\circ\text{C}$	
Input offset voltage long-term drift (see Note 4)			25°C	0.04		$\mu\text{V}/\text{mo}$	
$I_{IO}$	Input offset current		25°C	2		pA	
			Full range	20		nA	
$I_{IB}$	Input bias current	25°C	4		pA		
		Full range	40		nA		
$V_{ICR}$	Common-mode input voltage range	25°C	-11 to 13	-12 to 16	V		
		Full range	-11 to 13		V		
$V_{OM+}$	Maximum positive peak output voltage swing	$R_L = 10\ \text{k}\Omega$	25°C	13.2	13.7	V	
			Full range	12.5			
		$R_L = 600\ \Omega$	25°C	12.5	13.2		
			Full range	12			
$V_{OM-}$	Maximum negative peak output voltage swing	$R_L = 10\ \text{k}\Omega$	25°C	-13.2	-13.7	V	
			Full range	-12.5			
		$R_L = 600\ \Omega$	25°C	-12.5	-13		
			Full range	-12			
$A_{VD}$	Large-signal differential voltage amplification	$V_O = \pm 10\ \text{V}, R_L = 10\ \text{k}\Omega$	25°C	30	230	V/mV	
			Full range	20			
		$V_O = 0\ \text{to}\ 8\ \text{V}, R_L = 600\ \Omega$	25°C	25	100		
			Full range	7			
		$V_O = 0\ \text{to}\ -8\ \text{V}, R_L = 600\ \Omega$	25°C	3	25		
			Full range	1			
$r_i$	Input resistance		25°C	10 <sup>12</sup>		$\Omega$	
$c_i$	Input capacitance		25°C	4		pF	
$z_o$	Open-loop output impedance	$I_O = 0$	25°C	280		$\Omega$	
CMRR	Common-mode rejection ratio	$V_{IC} = V_{ICR\text{min}}, R_S = 50\ \Omega$	25°C	72	90	dB	
			Full range	65			
$k_{SVR}$	Supply-voltage rejection ratio ( $\Delta V_{CC\pm} / \Delta V_{IO}$ )	$V_{CC\pm} = \pm 5\ \text{V to } \pm 15\ \text{V}, R_S = 50\ \Omega$	25°C	75	93	dB	
			Full range	65			
$I_{CC}$	Supply current	$V_O = 0, \text{ No load}$	25°C	290	350	$\mu\text{A}$	
			Full range	375			
$\Delta I_{CC}$	Supply-current change over operating temperature range		Full range	46		$\mu\text{A}$	

† Full range is -55°C to 125°C.

NOTE 4: Typical values are based on the input offset voltage shift observed through 168 hours of operating life test at  $T_A = 150^\circ\text{C}$  extrapolated to  $T_A = 25^\circ\text{C}$  using the Arrhenius equation and assuming an activation energy of 0.96 eV.



TLE2161, TLE2161A, TLE2161B  
EXCALIBUR JFET-INPUT HIGH-OUTPUT-DRIVE  
 $\mu$ POWER OPERATIONAL AMPLIFIERS  
SLOS049D – NOVEMBER 1989 – REVISED MAY 1996

operating characteristics at specified free-air temperature,  $V_{CC} \pm = \pm 15$  V (unless otherwise noted)

PARAMETER	TEST CONDITIONS	$T_A$ †	TLE2161M TLE2161AM TLE2161BM			UNIT
			MIN	TYP	MAX	
SR Slew rate (see Figure 1)	$A_{VD} = 5, R_L = 10 \text{ k}\Omega, C_L = 100 \text{ pF}$	25°C	7	10		V/ $\mu$ s
		Full range	5			
$V_n$ Equivalent input noise voltage (see Figure 2)	$R_S = 20 \Omega, f = 10 \text{ Hz}$	25°C	70			nV/ $\sqrt{\text{Hz}}$
	$R_S = 20 \Omega, f = 1 \text{ kHz}$		40			
$V_{N(PP)}$ Peak-to-peak equivalent input noise voltage	$f = 0.1 \text{ Hz to } 10 \text{ Hz}$	25°C	1.1			$\mu$ V
$I_n$ Equivalent input noise current	$f = 1 \text{ Hz}$	25°C	1.1			fA/ $\sqrt{\text{Hz}}$
THD Total harmonic distortion	$V_{O(PP)} = 2 \text{ V}, A_{VD} = 5, f = 10 \text{ kHz}, R_L = 10 \text{ k}\Omega$	25°C	0.025%			
Gain-bandwidth product (see Figure 3)	$f = 100 \text{ kHz}, R_L = 10 \text{ k}\Omega, C_L = 100 \text{ pF}$	25°C	6.4			MHz
	$f = 100 \text{ kHz}, R_L = 600 \Omega, C_L = 100 \text{ pF}$		5.6			
$t_s$ Settling time	$\epsilon = 0.1\%$	25°C	5			$\mu$ s
	$\epsilon = 0.01\%$		10			
$B_{OM}$ Maximum output-swing bandwidth	$A_{VD} = 5, R_L = 10 \text{ k}\Omega$	25°C	116			kHz
$\phi_m$ Phase margin (see Figure 3)	$A_{VD} = 5, R_L = 10 \text{ k}\Omega, C_L = 100 \text{ pF}$	25°C	72°			
	$A_{VD} = 5, R_L = 600 \Omega, C_L = 100 \text{ pF}$		78°			

† Full range is – 55°C to 125°C.

PARAMETER MEASUREMENT INFORMATION

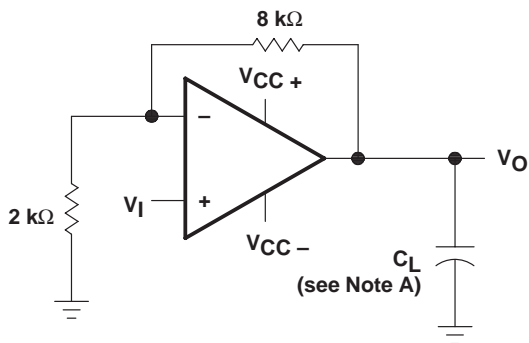

NOTE A: C<sub>L</sub> includes fixture capacitance.

Figure 1. Slew-Rate Test Circuit

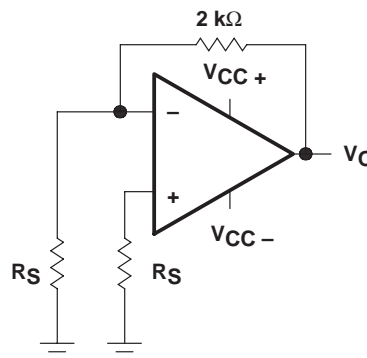
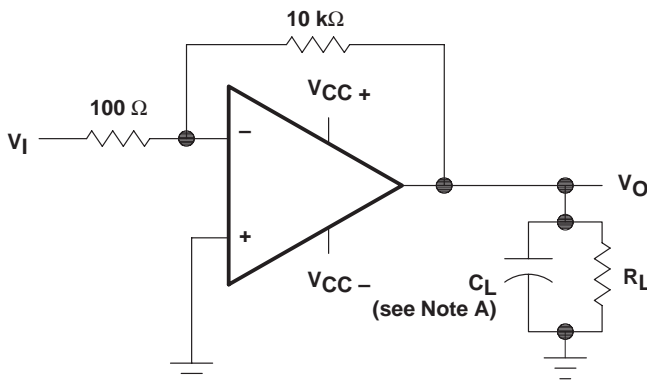

Figure 2. Noise-Voltage Test Circuit



NOTE A: C<sub>L</sub> includes fixture capacitance.

Figure 3. Gain-Bandwidth Product and Phase-Margin Test Circuit

typical values

Typical values presented in this data sheet represent the median (50% point) of device parametric performance.

Input bias and offset current

At the picoampere bias-current level typical of the TLE2161, TLE2161A, and TLE2161B, accurate measurement of the bias current becomes difficult. Not only does this measurement require a picoammeter, but test socket leakages can easily exceed the actual device bias currents. To accurately measure these small currents, Texas Instruments uses a two-step process. The socket leakage is measured using picoammeters with bias voltages applied but with no device in the socket. The device is then inserted into the socket, and a second test that measures both the socket leakage and the device input bias current is performed. The two measurements are then subtracted algebraically to determine the bias current of the device.

## TYPICAL CHARACTERISTICS

**Table of Graphs**

			FIGURE
$V_{IO}$	Input offset voltage	Distribution	4
$I_{IB}$	Input bias current	vs Common-mode input voltage	5
		vs Free-air temperature	6
$I_{IO}$	Input offset current	vs Free-air temperature	6
$V_{ICR}$	Common-mode input voltage range limits	vs Free-air temperature	7
$V_{OM}$	Maximum positive peak output voltage	vs Output current	8
$V_{OM}$	Maximum negative peak output voltage	vs Output current	9
$V_{OM}$	Maximum peak output voltage	vs Supply voltage	10, 11, 12
$V_{O(PP)}$	Maximum peak-to-peak output voltage	vs Frequency	13, 14, 15
$A_{VD}$	Large-signal differential voltage amplification	vs Frequency	16
		vs Free-air temperature	17
$I_{OS}$	Short-circuit output current	vs Elapsed time	18
		Large-signal voltage amplification	19
$z_o$	Output impedance	vs Frequency	20
CMRR	Common-mode rejection ratio	vs Frequency	21
$I_{CC}$	Supply current	vs Supply voltage	22
		vs Free-air temperature	23
	Pulse response	Small signal	24, 25
		Large signal	26, 27
	Noise voltage (referred to input)	0.1 to 10 Hz	28
$V_n$	Equivalent input noise voltage	vs Frequency	29
THD	Total harmonic distortion	vs Frequency	30, 31
		Gain-bandwidth product	32
		vs Supply voltage	33
		vs Free-air temperature	33
$\phi_m$	Phase margin	vs Supply voltage	34
		vs Free-air temperature	35
	Phase shift	vs Frequency	16

TYPICAL CHARACTERISTICS†

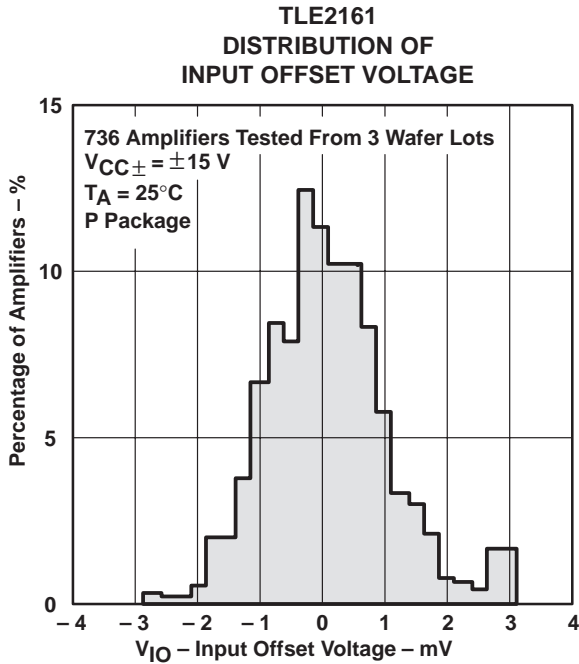

Figure 4

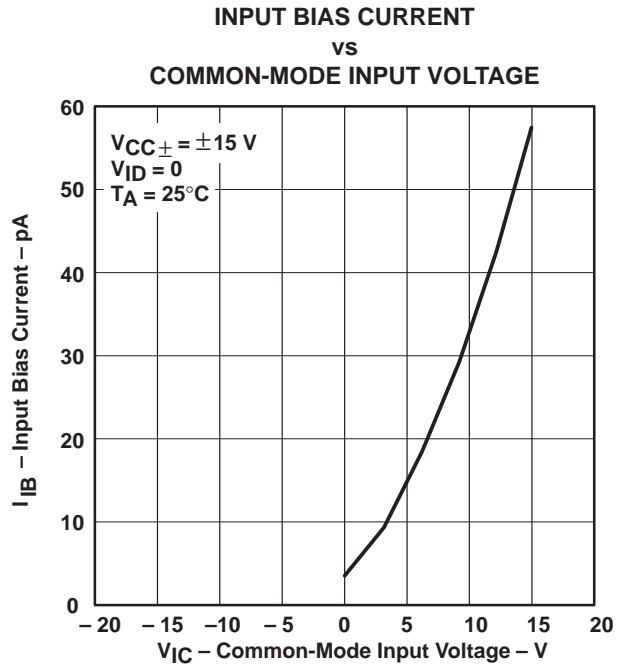

Figure 5

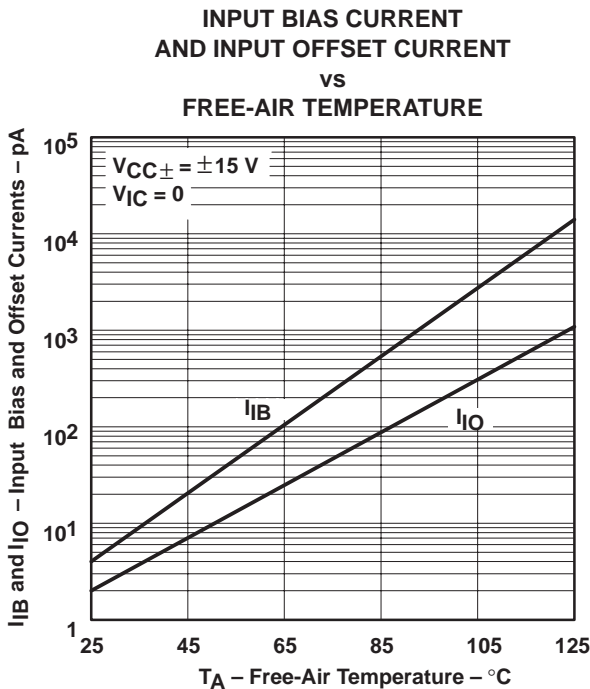

Figure 6

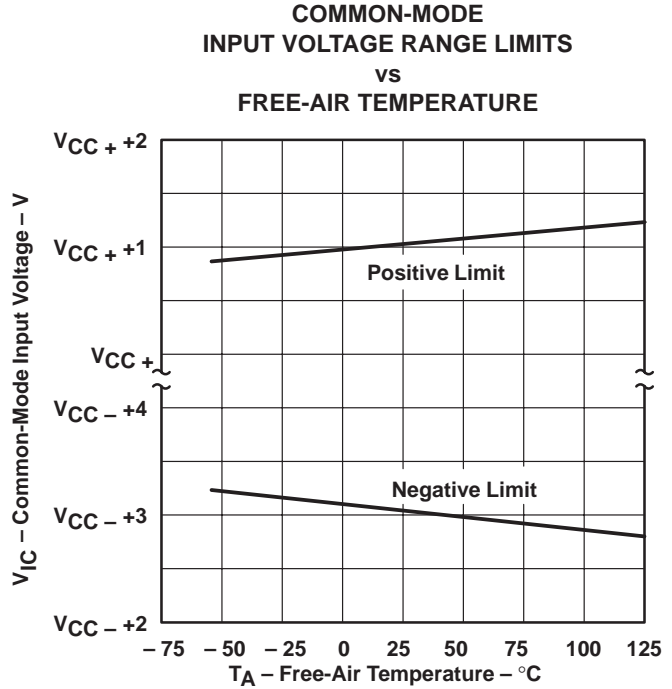

Figure 7

† Data at high and low temperatures are applicable only within the rated operating free-air temperature ranges of the various devices.

TYPICAL CHARACTERISTICS

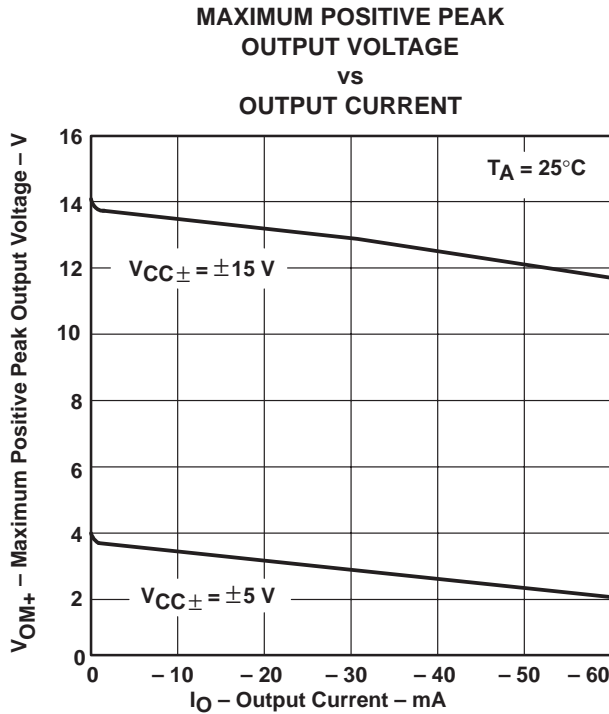

Figure 8

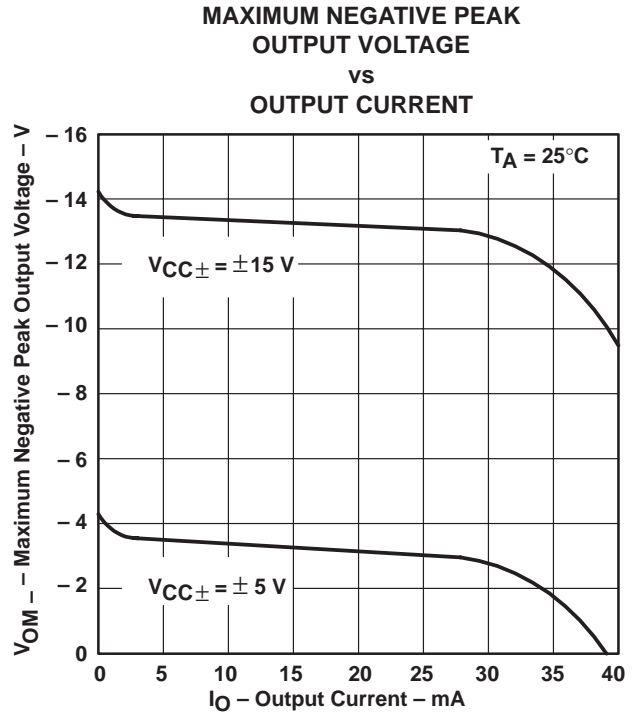

Figure 9

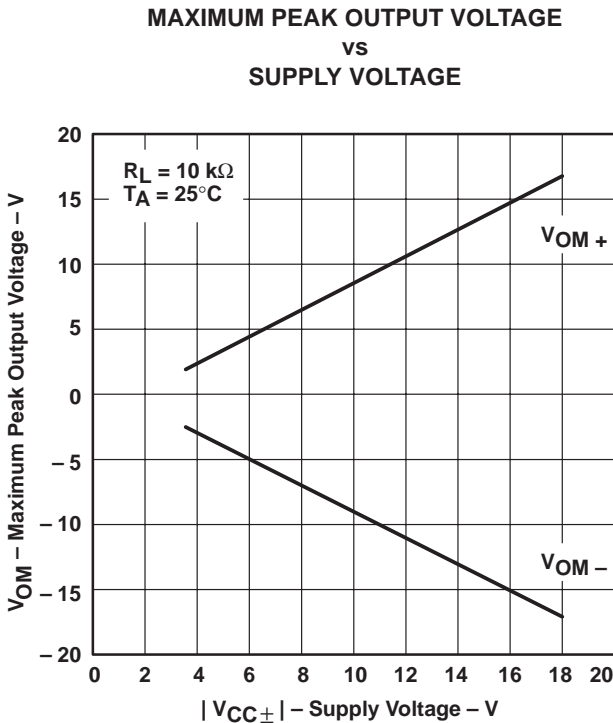

Figure 10

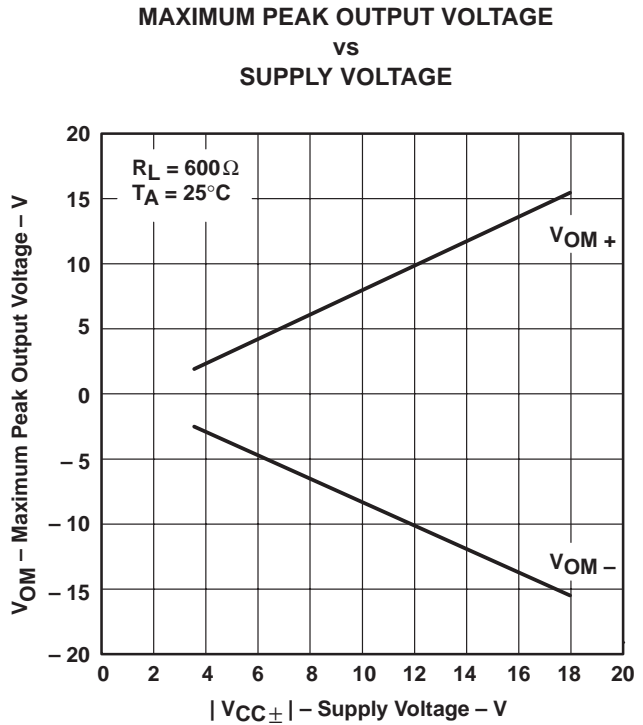

Figure 11

TYPICAL CHARACTERISTICS

MAXIMUM PEAK OUTPUT VOLTAGE  
 vs  
 SUPPLY VOLTAGE

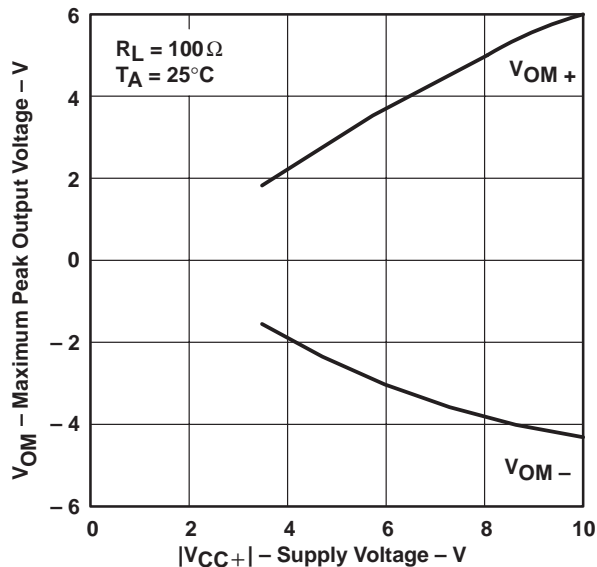

Figure 12

MAXIMUM PEAK-TO-PEAK  
 OUTPUT VOLTAGE  
 vs  
 FREQUENCY

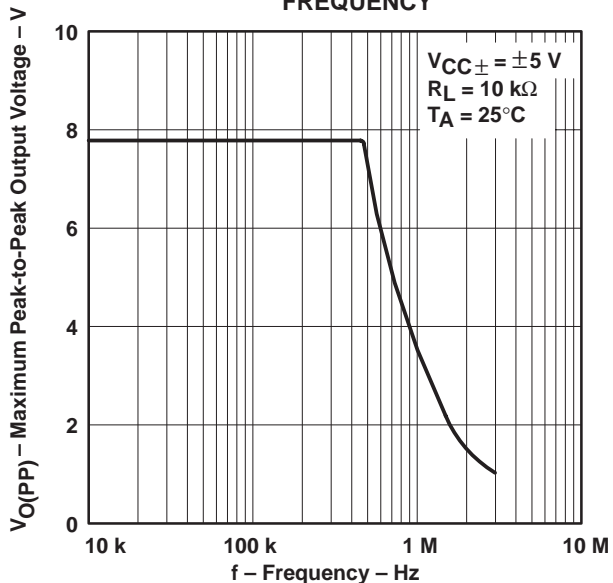

Figure 13

MAXIMUM PEAK-TO-PEAK  
 OUTPUT VOLTAGE  
 vs  
 FREQUENCY

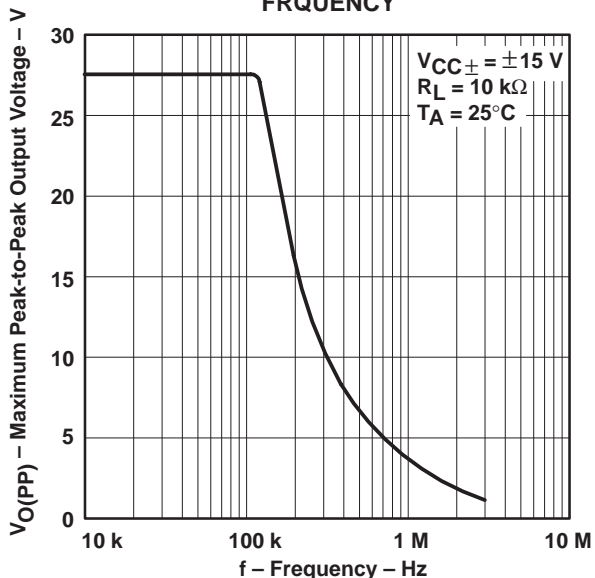

Figure 14

MAXIMUM PEAK-TO-PEAK  
 OUTPUT VOLTAGE  
 vs  
 FREQUENCY

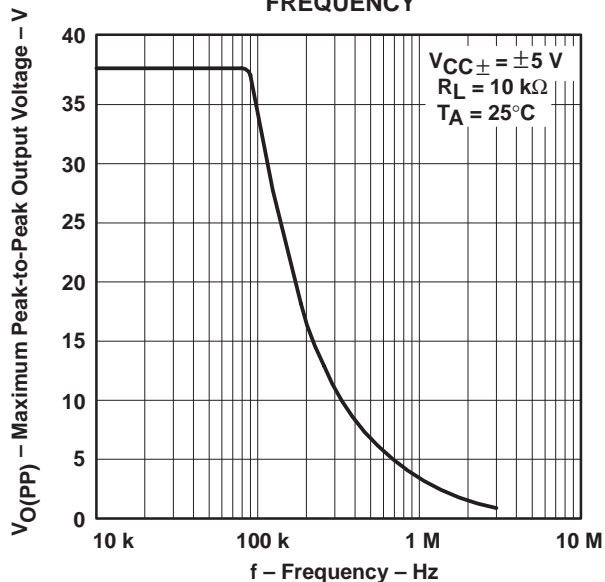

Figure 15

TYPICAL CHARACTERISTICS†

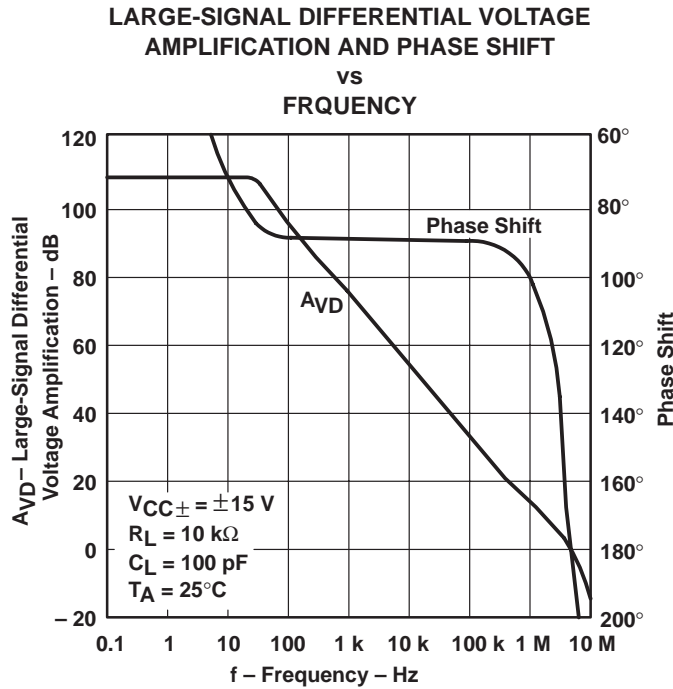

Figure 16

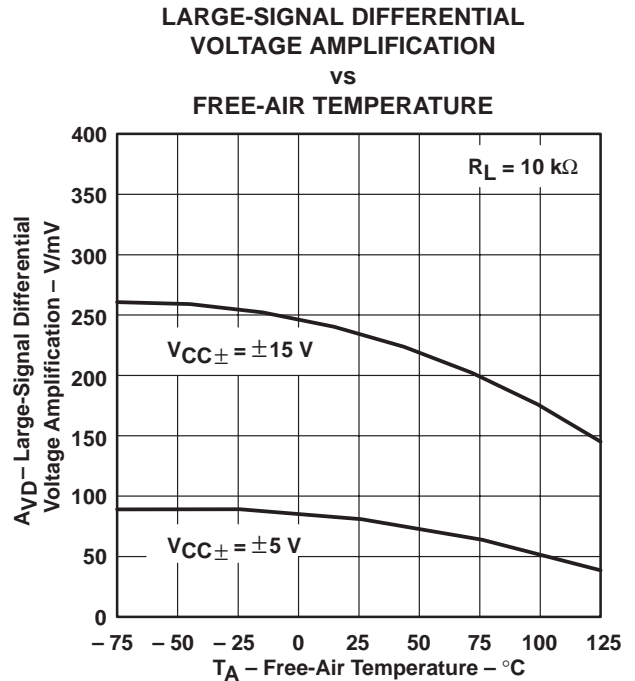

Figure 17

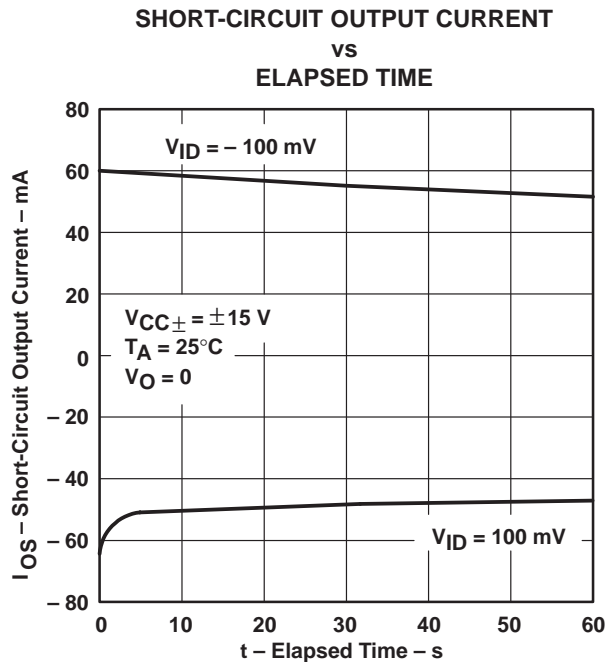

Figure 18

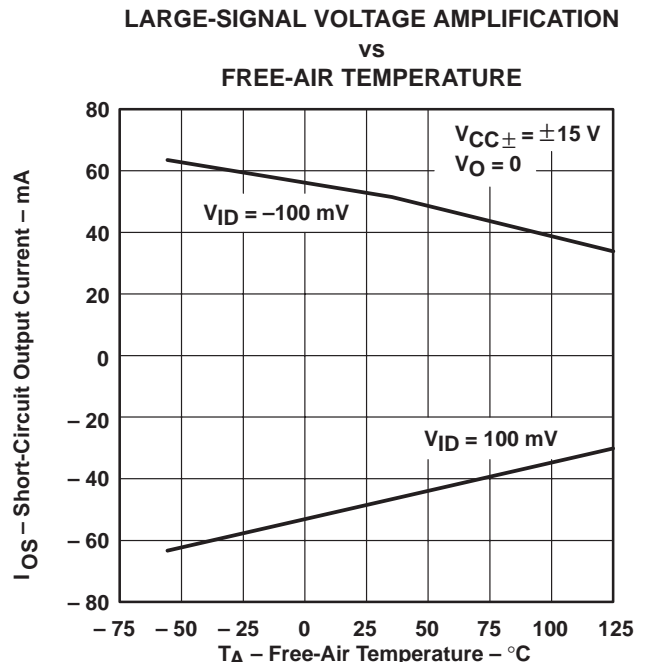

Figure 19

† Data at high and low temperatures are applicable only within the rated operating free-air temperature ranges of the various devices.

TYPICAL CHARACTERISTICS†

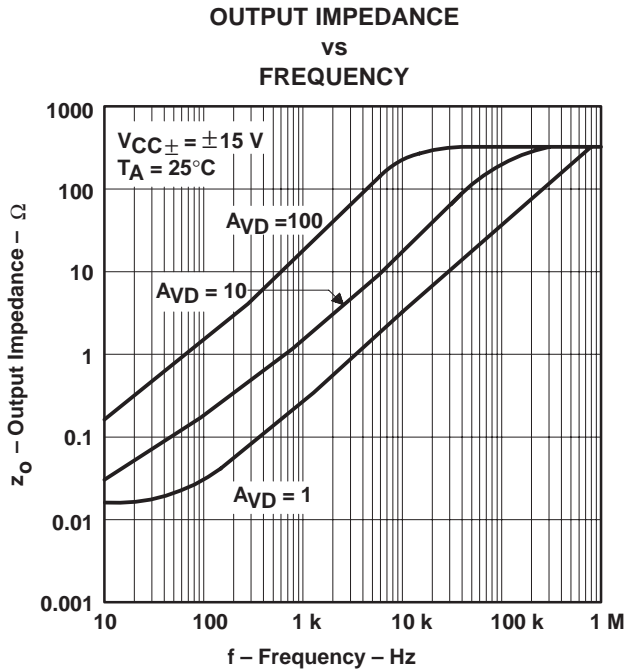

Figure 20

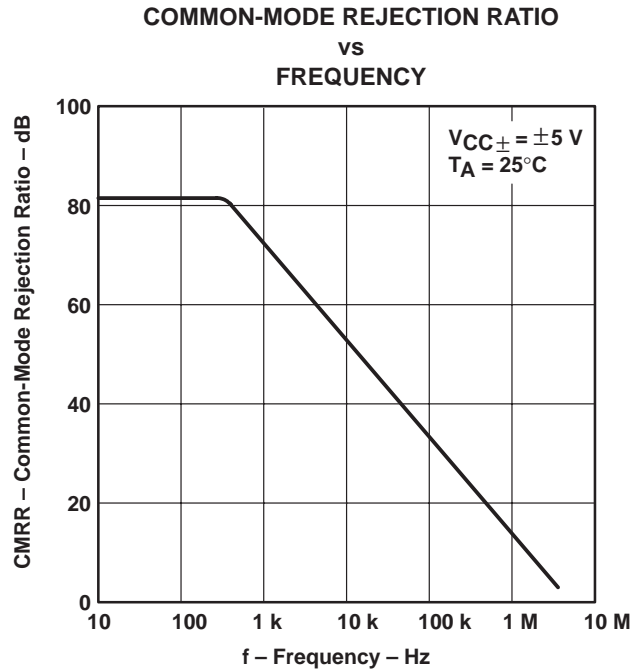

Figure 21

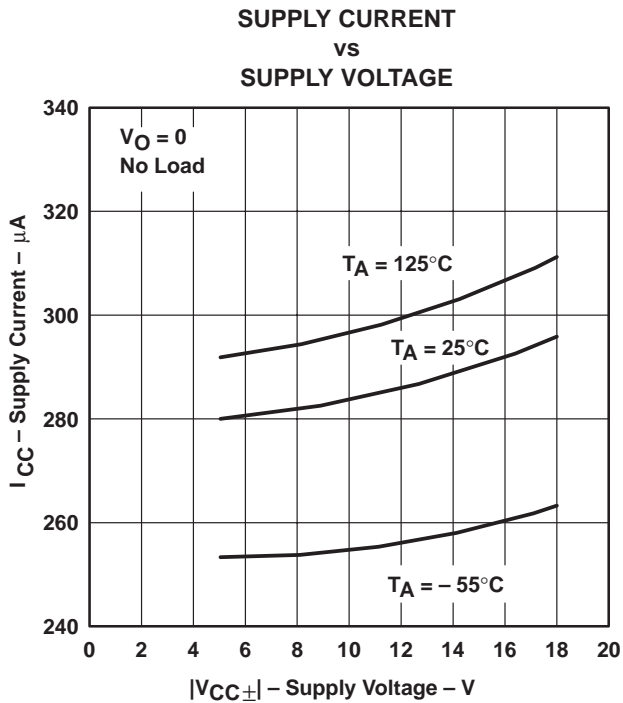

Figure 22

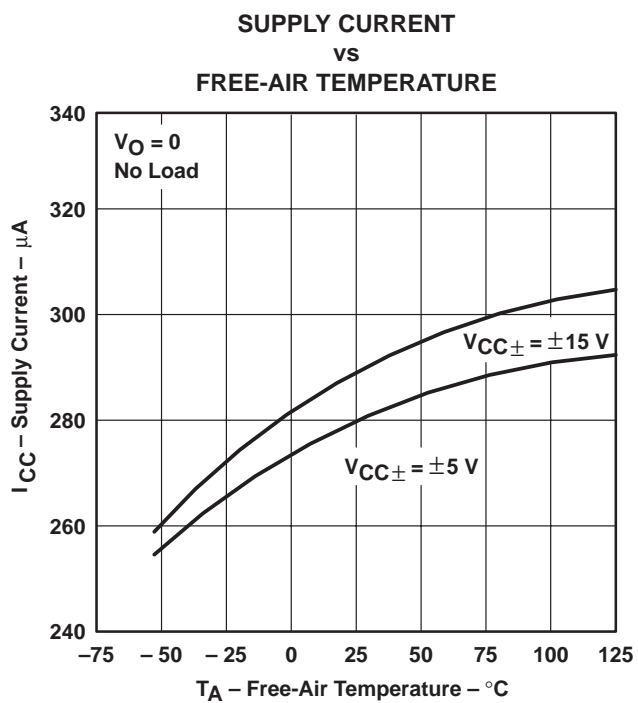

Figure 23

† Data at high and low temperatures are applicable only within the rated operating free-air temperature ranges of the various devices.

TYPICAL CHARACTERISTICS

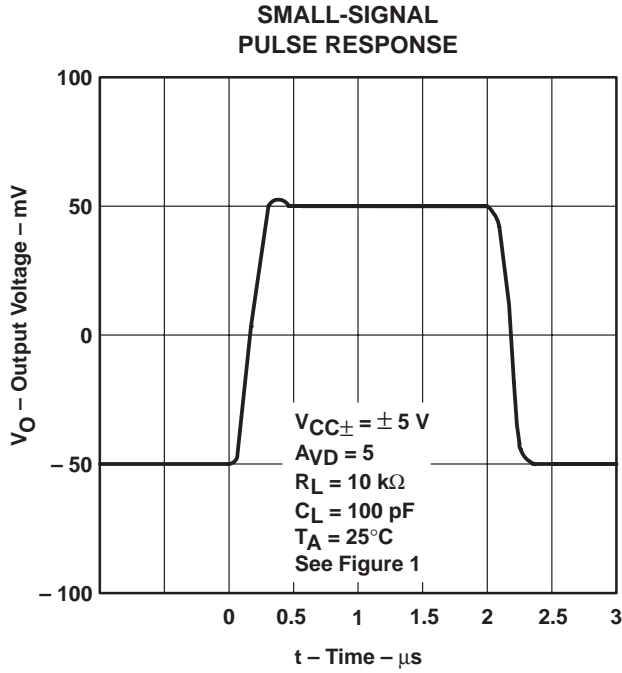

Figure 24

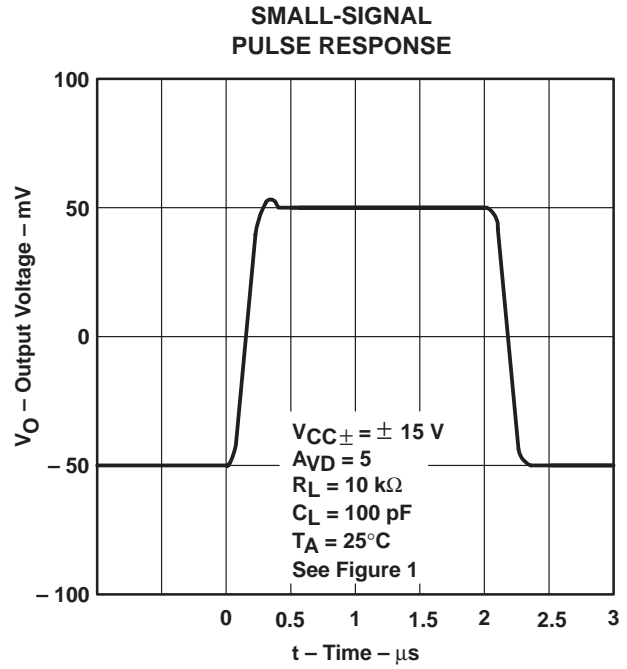

Figure 25

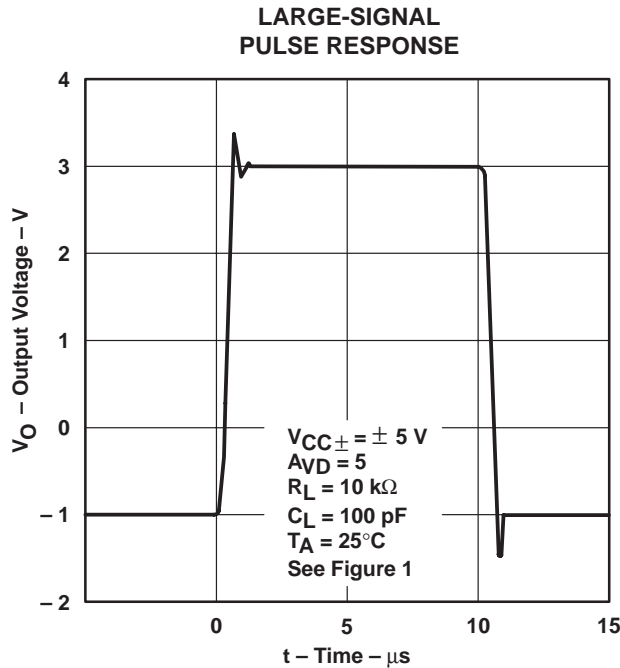

Figure 26

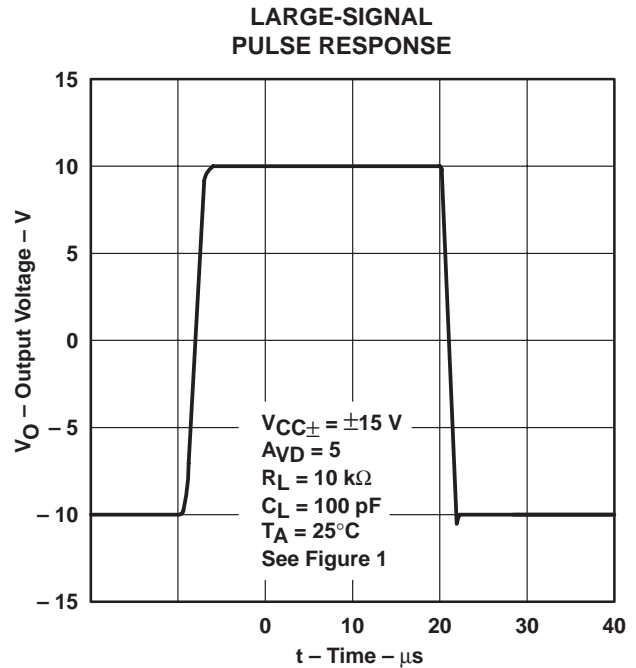

Figure 27

TYPICAL CHARACTERISTICS

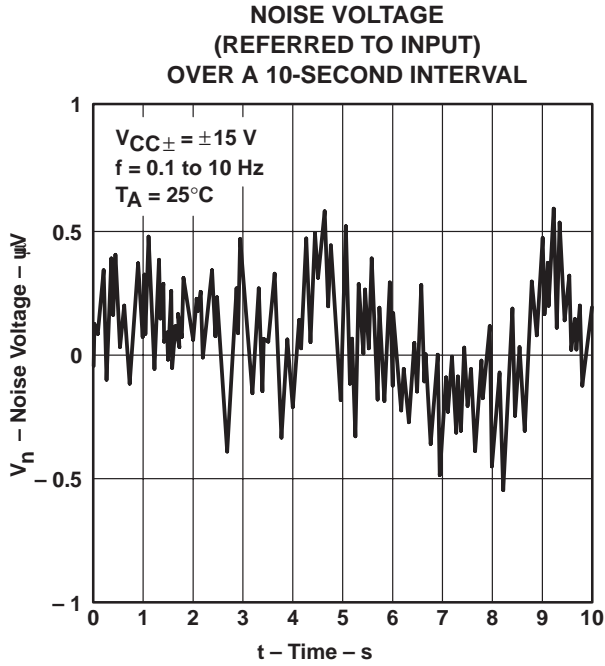

Figure 28

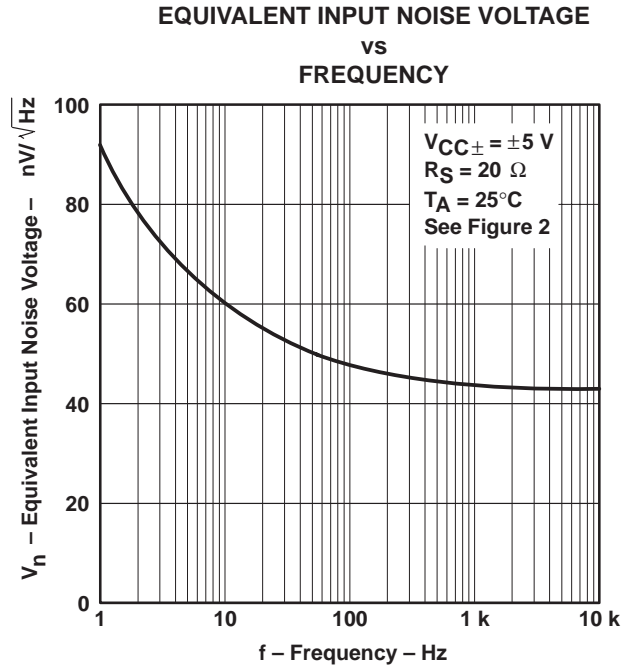

Figure 29

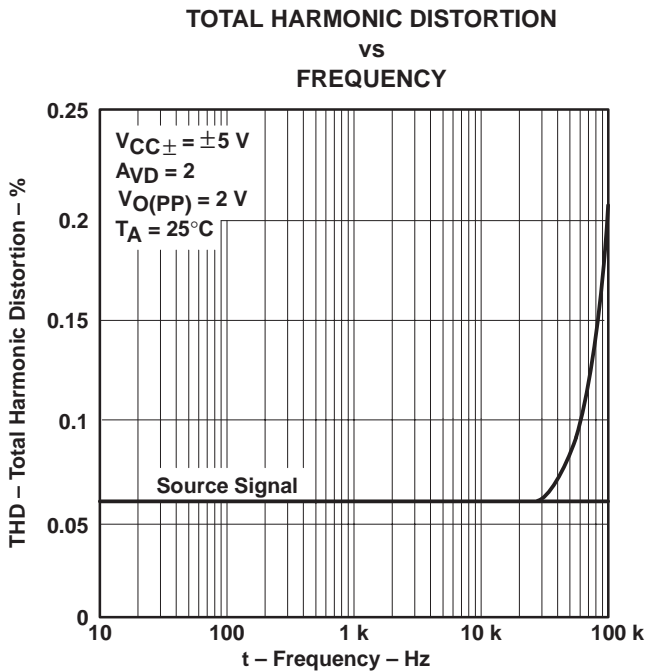

Figure 30

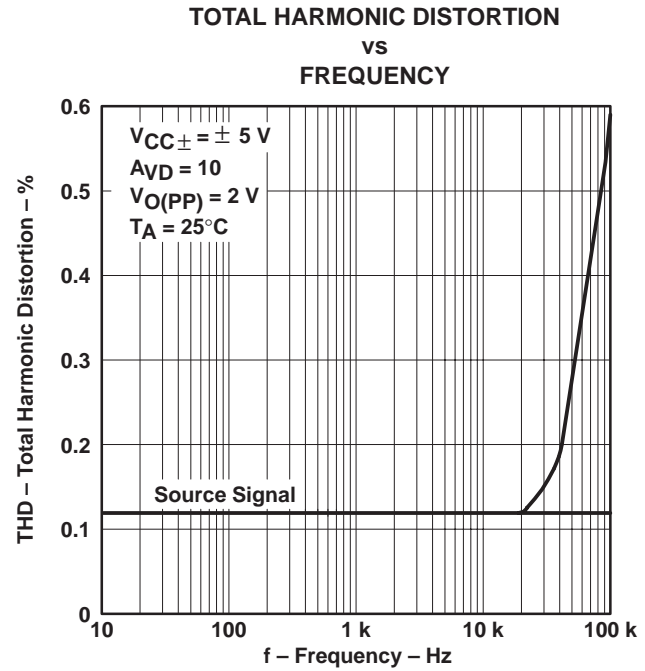

Figure 31

TYPICAL CHARACTERISTICS

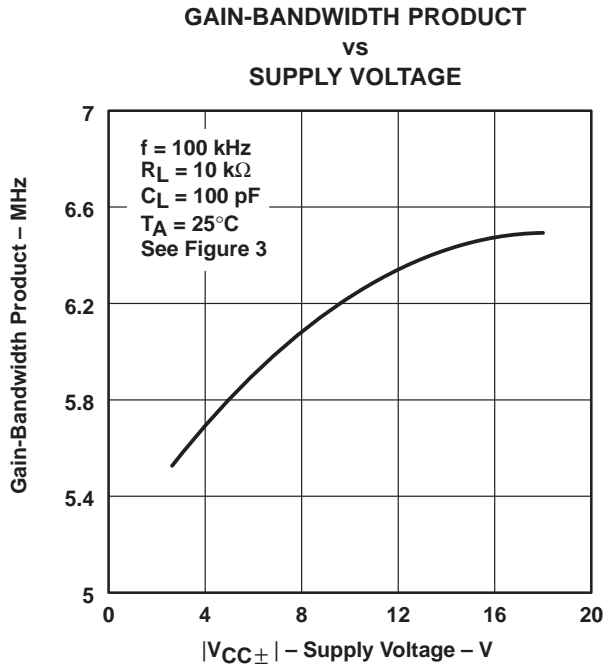

Figure 32

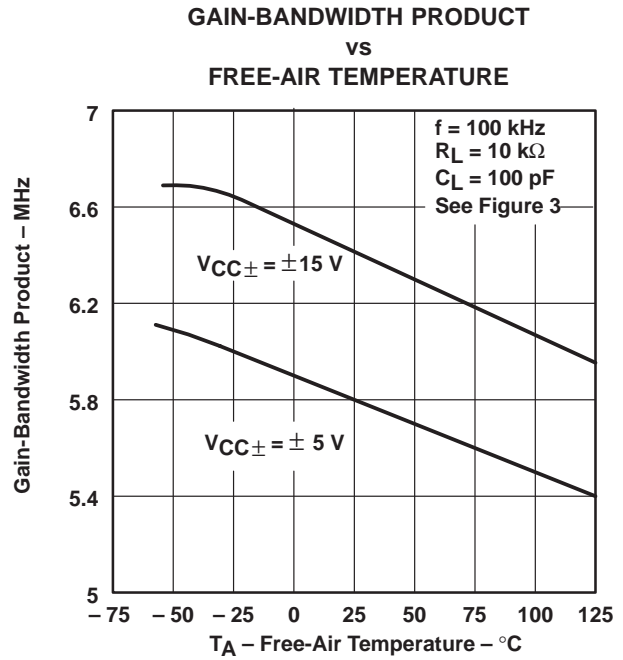

Figure 33

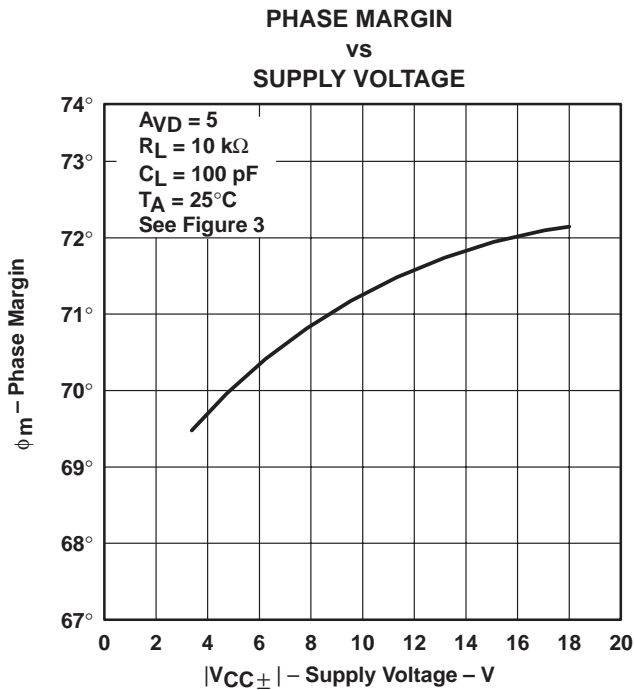

Figure 34

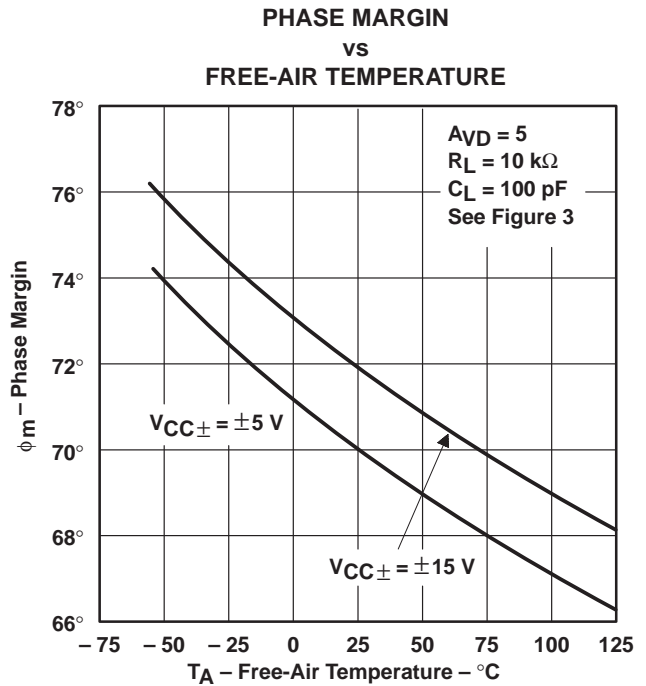

Figure 35

APPLICATION INFORMATION

macromodel information

Macromodel information provided was derived using Microsim *Parts*™, the model generation software used with Microsim *PSpice*™. The Boyle macromodel (see Note 5) and subcircuit in Figure 36 and Figure 37 were generated using the TLE2161 typical electrical and operating characteristics at 25°C. Using this information, output simulations of the following key parameters can be generated to a tolerance of 20% (in most cases):

- Maximum positive output voltage swing
- Maximum negative output voltage swing
- Slew rate
- Quiescent power dissipation
- Input bias current
- Open-loop voltage amplification
- Gain-bandwidth product
- Common-mode rejection ratio
- Phase margin
- DC output resistance
- AC output resistance
- Short-circuit output current limit

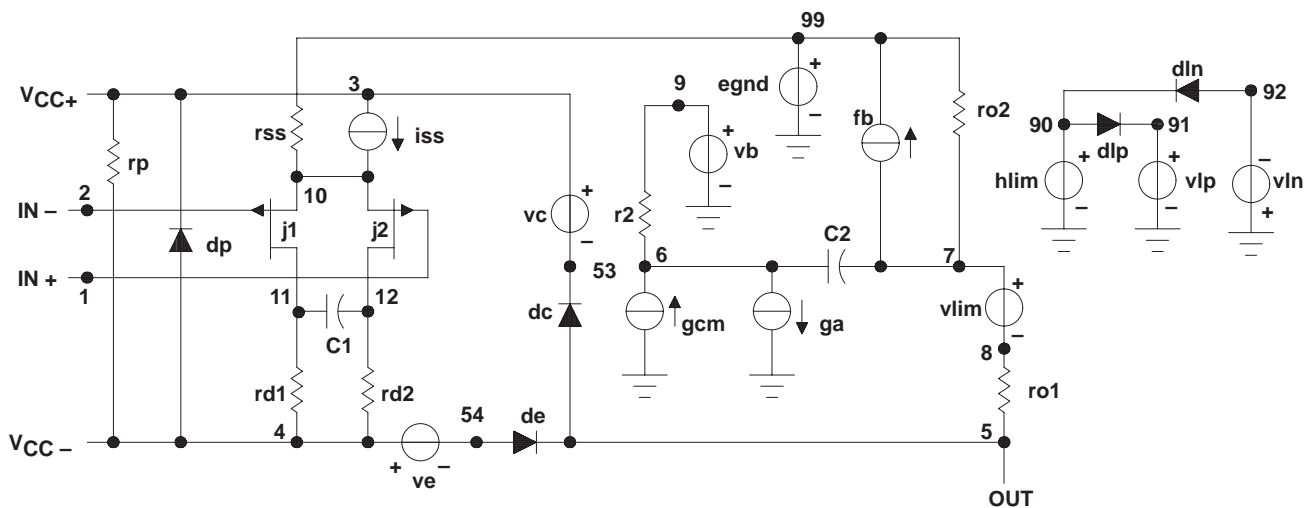

Figure 36. Boyle Macromodel

NOTE 5: G. R. Boyle, B. M. Cohn, D. O. Pederson, and J. E. Solomon, "Macromodeling of Integrated Circuit Operational Amplifiers", *IEEE Journal of Solid-State Circuits*, SC-9, 353 (1974).

*PSpice* and *Parts* are trademark of MicroSim Corporation.

**APPLICATION INFORMATION**

**macromodel information (continued)**

```
.subckt TLE2161 1 2 3 4 5
c1 11 12 125.4E-14
c2 6 7 5.000E-12
dc 5 53 dx
de 54 5d x
dlp 90 91 dx
dln 92 90 dx
dp 4 3 dx
egnd 99 0 poly(2) (3,0) (4,0) 0 .5 .5
fb 7 99 poly(5) vb vc ve vlp vln 0 4.085E6 -4E6 4E6 4E6 -4E6
ga 6 0 11 12 201.1E-6
gcm 0 6 10 99 3.576E-9
iss 3 10 dc 45.00E-6
hlim 90 0 vlim 1K
j1 11 2 10 jx
j2 12 1 10 jx
r2 6 9 100.0E3
rd1 4 11 4.973E3
rd2 4 12 4.973E3
ro1 8 5 280
ro2 7 99 280
rp 3 4 113.2E3
rss 10 99 4.444E6
vb 9 0 dc 0
vc 3 53 dc 2
ve 54 4 dc 2
vlim 7 8 dc 0
vlp 91 0 dc 50
vln 0 92 dc 50
.model dx D (Is=800.0E-18)
.model jx Pjf (Is=1.000E-12 Beta=480E-6 Vto=-1)
.ends
```

**Figure 37. Macromodel Subcircuit**

APPLICATION INFORMATION

input characteristics

The TLE2161, TLE2161A and TLE2161B are specified with a minimum and a maximum input voltage that if exceeded at either input could cause the device to malfunction.

Because of the extremely high input impedance and resulting low bias-current requirements, the TLE2161, TLE2161A, and TLE2161B are well suited for low-level signal processing; however, leakage currents on printed circuit boards and sockets can easily exceed bias-current requirements and cause degradation in system performance. It is a good practice to include guard rings around inputs (see Figure 38). These guards should be driven from a low-impedance source at the same voltage level as the common-mode input.

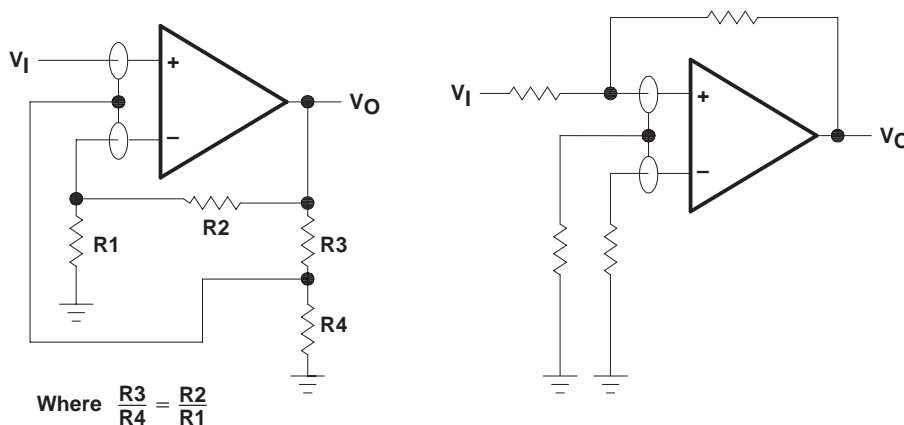

Figure 38. Use of Guard Rings

input offset voltage nulling

The TLE2161 series offers external null pins that can further reduce the input offset voltage. The circuit in Figure 39 can be connected as shown if the feature is desired. When external nulling is not needed, the null pins may be left disconnected.

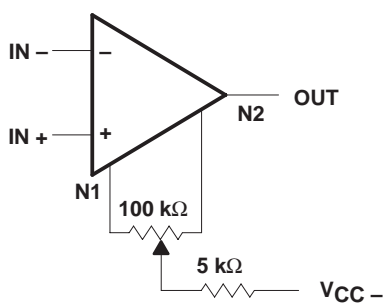

Figure 39. Input Offset Voltage Nulling

**PACKAGING INFORMATION**

Orderable Device	Status <sup>(1)</sup>	Package Type	Package Drawing	Pins	Package Qty	Eco Plan <sup>(2)</sup>	Lead/Ball Finish	MSL Peak Temp <sup>(3)</sup>
5962-9095801Q2A	ACTIVE	LCCC	FK	20	1	None	POST-PLATE	Level-NC-NC-NC
5962-9095801QPA	ACTIVE	CDIP	JG	8	1	None	A42 SNPB	Level-NC-NC-NC
5962-9095802Q2A	ACTIVE	LCCC	FK	20	1	None	POST-PLATE	Level-NC-NC-NC
5962-9095802QPA	ACTIVE	CDIP	JG	8	1	None	A42 SNPB	Level-NC-NC-NC
5962-9095803Q2A	ACTIVE	LCCC	FK	20	1	None	POST-PLATE	Level-NC-NC-NC
5962-9095803QPA	ACTIVE	CDIP	JG	8	1	None	A42 SNPB	Level-NC-NC-NC
TLE2161ACD	ACTIVE	SOIC	D	8	75	Pb-Free (RoHS)	CU NIPDAU	Level-2-260C-1YEAR/ Level-1-220C-UNLIM
TLE2161ACP	OBSOLETE	PDIP	P	8		None	Call TI	Call TI
TLE2161AID	ACTIVE	SOIC	D	8	75	Pb-Free (RoHS)	CU NIPDAU	Level-2-260C-1YEAR/ Level-1-220C-UNLIM
TLE2161AIDR	ACTIVE	SOIC	D	8	2500	Pb-Free (RoHS)	CU NIPDAU	Level-2-260C-1YEAR/ Level-1-220C-UNLIM
TLE2161AIP	OBSOLETE	PDIP	P	8		None	Call TI	Call TI
TLE2161AMFKB	ACTIVE	LCCC	FK	20	1	None	POST-PLATE	Level-NC-NC-NC
TLE2161AMJGB	ACTIVE	CDIP	JG	8	1	None	A42 SNPB	Level-NC-NC-NC
TLE2161BCP	OBSOLETE	PDIP	P	8		None	Call TI	Call TI
TLE2161BIP	OBSOLETE	PDIP	P	8		None	Call TI	Call TI
TLE2161BMFKB	ACTIVE	LCCC	FK	20	1	None	POST-PLATE	Level-NC-NC-NC
TLE2161BMJG	ACTIVE	CDIP	JG	8	1	None	A42 SNPB	Level-NC-NC-NC
TLE2161BMJGB	ACTIVE	CDIP	JG	8	1	None	A42 SNPB	Level-NC-NC-NC
TLE2161BMP	OBSOLETE	PDIP	P	8		None	Call TI	Call TI
TLE2161CD	ACTIVE	SOIC	D	8	75	Pb-Free (RoHS)	CU NIPDAU	Level-2-260C-1YEAR/ Level-1-220C-UNLIM
TLE2161CP	OBSOLETE	PDIP	P	8		None	Call TI	Call TI
TLE2161ID	ACTIVE	SOIC	D	8	75	Pb-Free (RoHS)	CU NIPDAU	Level-2-260C-1YEAR/ Level-1-220C-UNLIM
TLE2161IDR	ACTIVE	SOIC	D	8	2500	Pb-Free (RoHS)	CU NIPDAU	Level-2-260C-1YEAR/ Level-1-220C-UNLIM
TLE2161IP	OBSOLETE	PDIP	P	8		None	Call TI	Call TI
TLE2161MFKB	ACTIVE	LCCC	FK	20	1	None	POST-PLATE	Level-NC-NC-NC
TLE2161MJGB	ACTIVE	CDIP	JG	8	1	None	A42 SNPB	Level-NC-NC-NC
TLE2161MP	OBSOLETE	PDIP	P	8		None	Call TI	Call TI

<sup>(1)</sup> The marketing status values are defined as follows:

**ACTIVE:** Product device recommended for new designs.

**LIFEBUY:** TI has announced that the device will be discontinued, and a lifetime-buy period is in effect.

**NRND:** Not recommended for new designs. Device is in production to support existing customers, but TI does not recommend using this part in a new design.

**PREVIEW:** Device has been announced but is not in production. Samples may or may not be available.

**OBSOLETE:** TI has discontinued the production of the device.

<sup>(2)</sup> Eco Plan - May not be currently available - please check <http://www.ti.com/productcontent> for the latest availability information and additional product content details.

**None:** Not yet available Lead (Pb-Free).

**Pb-Free (RoHS):** TI's terms "Lead-Free" or "Pb-Free" mean semiconductor products that are compatible with the current RoHS requirements for all 6 substances, including the requirement that lead not exceed 0.1% by weight in homogeneous materials. Where designed to be soldered at high temperatures, TI Pb-Free products are suitable for use in specified lead-free processes.

**Green (RoHS & no Sb/Br):** TI defines "Green" to mean "Pb-Free" and in addition, uses package materials that do not contain halogens, including bromine (Br) or antimony (Sb) above 0.1% of total product weight.

<sup>(3)</sup> MSL, Peak Temp. -- The Moisture Sensitivity Level rating according to the JEDEC industry standard classifications, and peak solder temperature.

**Important Information and Disclaimer:** The information provided on this page represents TI's knowledge and belief as of the date that it is provided. TI bases its knowledge and belief on information provided by third parties, and makes no representation or warranty as to the accuracy of such information. Efforts are underway to better integrate information from third parties. TI has taken and continues to take reasonable steps to provide representative and accurate information but may not have conducted destructive testing or chemical analysis on incoming materials and chemicals. TI and TI suppliers consider certain information to be proprietary, and thus CAS numbers and other limited information may not be available for release.

In no event shall TI's liability arising out of such information exceed the total purchase price of the TI part(s) at issue in this document sold by TI to Customer on an annual basis.

## IMPORTANT NOTICE

Texas Instruments Incorporated and its subsidiaries (TI) reserve the right to make corrections, modifications, enhancements, improvements, and other changes to its products and services at any time and to discontinue any product or service without notice. Customers should obtain the latest relevant information before placing orders and should verify that such information is current and complete. All products are sold subject to TI's terms and conditions of sale supplied at the time of order acknowledgment.

TI warrants performance of its hardware products to the specifications applicable at the time of sale in accordance with TI's standard warranty. Testing and other quality control techniques are used to the extent TI deems necessary to support this warranty. Except where mandated by government requirements, testing of all parameters of each product is not necessarily performed.

TI assumes no liability for applications assistance or customer product design. Customers are responsible for their products and applications using TI components. To minimize the risks associated with customer products and applications, customers should provide adequate design and operating safeguards.

TI does not warrant or represent that any license, either express or implied, is granted under any TI patent right, copyright, mask work right, or other TI intellectual property right relating to any combination, machine, or process in which TI products or services are used. Information published by TI regarding third-party products or services does not constitute a license from TI to use such products or services or a warranty or endorsement thereof. Use of such information may require a license from a third party under the patents or other intellectual property of the third party, or a license from TI under the patents or other intellectual property of TI.

Reproduction of information in TI data books or data sheets is permissible only if reproduction is without alteration and is accompanied by all associated warranties, conditions, limitations, and notices. Reproduction of this information with alteration is an unfair and deceptive business practice. TI is not responsible or liable for such altered documentation.

Resale of TI products or services with statements different from or beyond the parameters stated by TI for that product or service voids all express and any implied warranties for the associated TI product or service and is an unfair and deceptive business practice. TI is not responsible or liable for any such statements.

Following are URLs where you can obtain information on other Texas Instruments products and application solutions:

<b>Products</b>		<b>Applications</b>	
Amplifiers	<a href="http://amplifier.ti.com">amplifier.ti.com</a>	Audio	<a href="http://www.ti.com/audio">www.ti.com/audio</a>
Data Converters	<a href="http://dataconverter.ti.com">dataconverter.ti.com</a>	Automotive	<a href="http://www.ti.com/automotive">www.ti.com/automotive</a>
DSP	<a href="http://dsp.ti.com">dsp.ti.com</a>	Broadband	<a href="http://www.ti.com/broadband">www.ti.com/broadband</a>
Interface	<a href="http://interface.ti.com">interface.ti.com</a>	Digital Control	<a href="http://www.ti.com/digitalcontrol">www.ti.com/digitalcontrol</a>
Logic	<a href="http://logic.ti.com">logic.ti.com</a>	Military	<a href="http://www.ti.com/military">www.ti.com/military</a>
Power Mgmt	<a href="http://power.ti.com">power.ti.com</a>	Optical Networking	<a href="http://www.ti.com/opticalnetwork">www.ti.com/opticalnetwork</a>
Microcontrollers	<a href="http://microcontroller.ti.com">microcontroller.ti.com</a>	Security	<a href="http://www.ti.com/security">www.ti.com/security</a>
		Telephony	<a href="http://www.ti.com/telephony">www.ti.com/telephony</a>
		Video & Imaging	<a href="http://www.ti.com/video">www.ti.com/video</a>
		Wireless	<a href="http://www.ti.com/wireless">www.ti.com/wireless</a>

Mailing Address: Texas Instruments  
Post Office Box 655303 Dallas, Texas 75265