

# TLV2432, TLV2432A, TLV2434, TLV2434A Advanced LinCMOS™ RAIL-TO-RAIL OUTPUT WIDE-INPUT-VOLTAGE OPERATIONAL AMPLIFIERS

SLOS168F – NOVEMBER 1996 – REVISED MARCH 2001

- Output Swing Includes Both Supply Rails
- Extended Common-Mode Input Voltage Range . . . 0 V to 4.5 V (Min) with 5-V Single Supply
- No Phase Inversion
- Low Noise . . . 18 nV/√Hz Typ at f = 1 kHz
- Low Input Offset Voltage  
950 μV Max at T<sub>A</sub> = 25°C (TLV243xA)
- Low Input Bias Current . . . 1 pA Typ
- Very Low Supply Current . . . 125 μA Per Channel Max
- 600-Ω Output Drive
- Macromodel Included
- Available in Q-Temp Automotive HighRel Automotive Applications Configuration Control / Print Support Qualification to Automotive Standards

## description

The TLV243x and TLV243xA are low-voltage operational amplifier from Texas Instruments. The common-mode input voltage range for each device is extended over the typical CMOS amplifiers making them suitable for a wide range of applications. In addition, these devices do not phase invert when the common-mode input is driven to the supply rails. This satisfies most design requirements without paying a premium for rail-to-rail input performance. They also exhibit rail-to-rail output performance for increased dynamic range in single- or split-supply applications. This family is fully characterized at 3-V and 5-V supplies and is optimized for low-voltage operation. The TLV243x only requires 100 μA (typ) of supply current per channel, making it ideal for battery-powered applications. The TLV243x also has increased output drive over previous rail-to-rail operational amplifiers and can drive 600-Ω loads for telecom applications.

The other members in the TLV243x family are the high-power, TLV244x, and micro-power, TLV2422, versions.

The TLV243x, exhibiting high input impedance and low noise, is excellent for small-signal conditioning for high-impedance sources, such as piezoelectric transducers. Because of the micropower dissipation levels and low-voltage operation, these devices work well in hand-held monitoring and remote-sensing applications. In addition, the rail-to-rail output feature with single- or split-supplies makes this family a great choice when interfacing with analog-to-digital converters (ADCs). For precision applications, the TLV243xA is available and has a maximum input offset voltage of 950 μV.

If the design requires single operational amplifiers, see the TI TLV2211/21/31. This is a family of rail-to-rail output operational amplifiers in the SOT-23 package. Their small size and low power consumption, make them ideal for high density, battery-powered equipment.

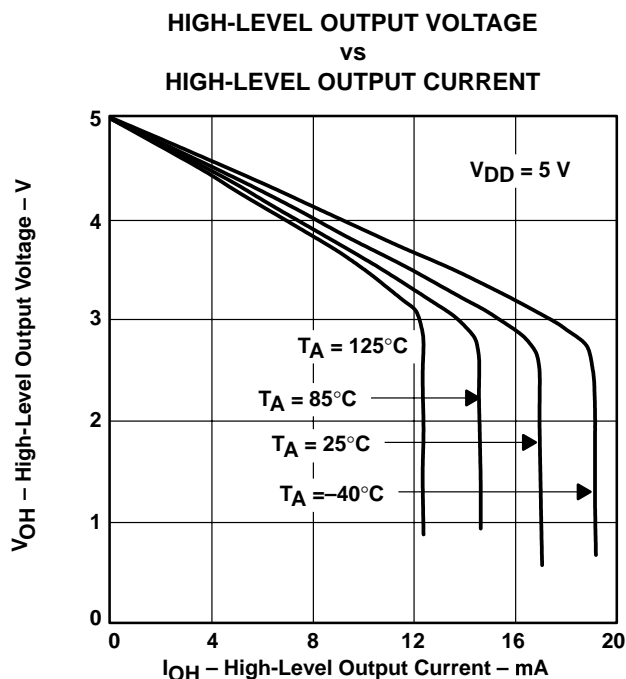

Figure 1



Please be aware that an important notice concerning availability, standard warranty, and use in critical applications of Texas Instruments semiconductor products and disclaimers thereto appears at the end of this data sheet.

Advanced LinCMOS is a trademark of Texas Instruments.

PRODUCTION DATA information is current as of publication date. Products conform to specifications per the terms of Texas Instruments standard warranty. Production processing does not necessarily include testing of all parameters.

 **TEXAS  
INSTRUMENTS**

POST OFFICE BOX 655303 • DALLAS, TEXAS 75265

Copyright © 2001, Texas Instruments Incorporated  
On products compliant to MIL-PRF-38535, all parameters are tested unless otherwise noted. On all other products, production processing does not necessarily include testing of all parameters.

# TLV2432, TLV2432A, TLV2434, TLV2434A

## Advanced LinCMOS™ RAIL-TO-RAIL OUTPUT

### WIDE-INPUT-VOLTAGE OPERATIONAL AMPLIFIERS

SLOS168F – NOVEMBER 1996 – REVISED MARCH 2001

#### TLV2432 and TLV2432A AVAILABLE OPTIONS

T <sub>A</sub>	V <sub>IO</sub> max AT 25°C	PACKAGED DEVICES				
		SMALL OUTLINE (D)	CHIP CARRIER (FK)	CERAMIC DIP (JG)	TSSOP (PW)	CERAMIC FLAT PACK (U)
0°C to 70°C	2.5 mV	TLV2432CD	—	—	TLV2432CPW	—
–40°C to 85°C	950 μV 2.5 mV	TLV2432AID TLV2432ID	— —	— —	TLV2432AIPW —	— —
–40°C to 125°C	950 μV 2.5 mV	TLV2432AQD TLV2432QD	— —	— —	— —	— —
–55°C to 125°C	950 μV 2.5 mV	— —	TLV2432AMFK TLV2432MFK	TLV2432AMJG TLV2432MJG	— —	TLV2432AMU TLV2432MU

The D packages are available taped and reeled. Add R suffix to device type (e.g., TLV2432CDR). The PW package is available only left-end taped and reeled.

#### TLV2434 AVAILABLE OPTIONS

T <sub>A</sub>	V <sub>IO</sub> max AT 25°C	PACKAGED DEVICES	
		SMALL OUTLINE (D)	TSSOP (PW)
0°C to 70°C	2.5 mV	TLV2434CD	TLV2434CPW
–40°C to 125°C	950 μV 2.5 mV	TLV2434AID TLV2434ID	TLV2434AIPW TLV2434IPW

The D packages are available taped and reeled. Add R suffix to device type (e.g., TLV2434CDR). The PW package is available only left-end taped and reeled.

**TLV2432  
D OR JG PACKAGE  
(TOP VIEW)**

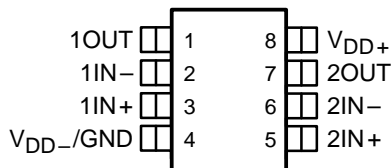

**TLV2432  
PW PACKAGE  
(TOP VIEW)**

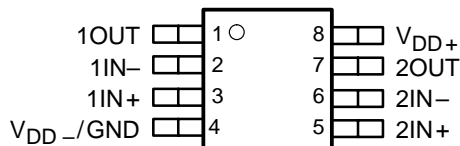

**TLV2432  
FK PACKAGE  
(TOP VIEW)**

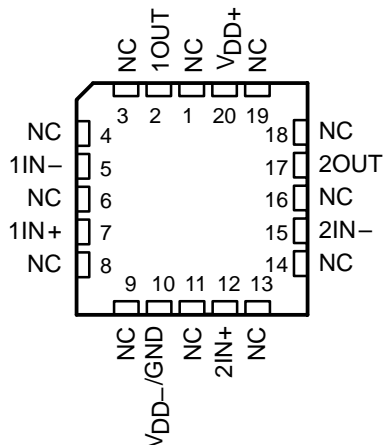

**TLV2432  
U PACKAGE  
(TOP VIEW)**

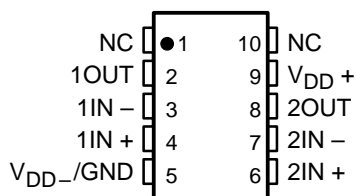

**TLV2434  
D OR PW PACKAGE  
(TOP VIEW)**

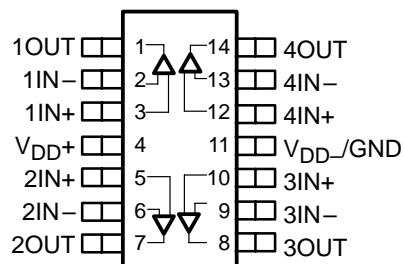

NC – No internal connection

TLV2432, TLV2432A, TLV2434, TLV2434A  
 Advanced LINCOS™ RAIL-TO-RAIL OUTPUT  
 WIDE-INPUT-VOLTAGE OPERATIONAL AMPLIFIERS  
 SLOS168F – NOVEMBER 1996 – REVISED MARCH 2001

equivalent schematic (each amplifier)

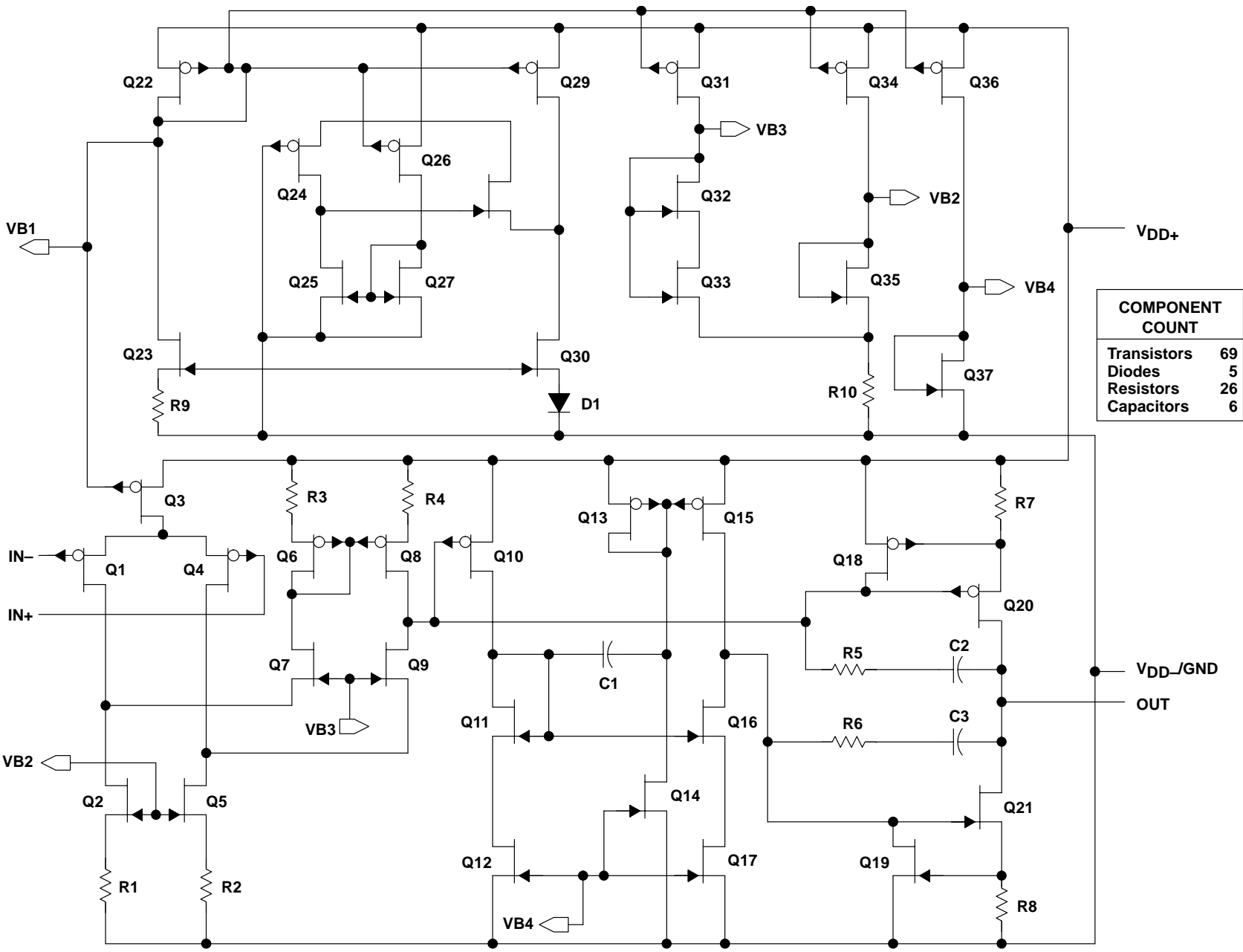

COMPONENT COUNT	
Transistors	69
Diodes	5
Resistors	26
Capacitors	6

**TLV2432, TLV2432A, TLV2434, TLV2434A**  
**Advanced LinCMOS™ RAIL-TO-RAIL OUTPUT**  
**WIDE-INPUT-VOLTAGE OPERATIONAL AMPLIFIERS**

SLOS168F – NOVEMBER 1996 – REVISED MARCH 2001

**absolute maximum ratings over operating free-air temperature range (unless otherwise noted)†**

Supply voltage, $V_{DD}$ (see Note 1)	12 V
Differential input voltage, $V_{ID}$ (see Note 2)	$\pm V_{DD}$
Input voltage, $V_I$ (any input, see Note 1): C and I suffix	-0.3 V to $V_{DD}$
Input current, $I_I$ (each input)	$\pm 5$ mA
Output current, $I_O$	$\pm 50$ mA
Total current into $V_{DD+}$	$\pm 50$ mA
Total current out of $V_{DD-}$	$\pm 50$ mA
Duration of short-circuit current at (or below) 25°C (see Note 3)	unlimited
Continuous total dissipation	See Dissipation Rating Table
Operating free-air temperature range, $T_A$ : C suffix	0°C to 70°C
I suffix (dual)	-40°C to 85°C
I suffix (quad)	-40°C to 125°C
Q suffix	-40°C to 125°C
M suffix	-55°C to 125°C
Storage temperature range, $T_{stg}$	-65°C to 150°C
Lead temperature 1,6 mm (1/16 inch) from case for 10 seconds	260°C

† Stresses beyond those listed under “absolute maximum ratings” may cause permanent damage to the device. These are stress ratings only, and functional operation of the device at these or any other conditions beyond those indicated under “recommended operating conditions” is not implied. Exposure to absolute-maximum-rated conditions for extended periods may affect device reliability.

- NOTES: 1. All voltage values, except differential voltages, are with respect to the midpoint between  $V_{DD+}$  and  $V_{DD-}$ .  
 2. Differential voltages are at  $IN+$  with respect to  $IN-$ . Excessive current flows if input is brought below  $V_{DD-} - 0.3$  V.  
 3. The output may be shorted to either supply. Temperature and/or supply voltages must be limited to ensure that the maximum dissipation rating is not exceeded.

**DISSIPATION RATING TABLE**

PACKAGE	$T_A \leq 25^\circ\text{C}$ POWER RATING	DERATING FACTOR ABOVE $T_A = 25^\circ\text{C}$	$T_A = 70^\circ\text{C}$ POWER RATING	$T_A = 85^\circ\text{C}$ POWER RATING	$T_A = 125^\circ\text{C}$ POWER RATING
D (8)	725 mW	5.8 mW/°C	464 mW	377 mW	145 mW
D (14)	1022 mW	7.6 mW/°C	900 mW	777 mW	450 mW
FK	1375 mW	11.0 mW/°C	880 mW	715 mW	275 mW
JG	1050 mW	8.4 mW/°C	672 mW	546 mW	210 mW
PW (8)	525 mW	4.2 mW/°C	336 mW	273 mW	105 mW
PW (14)	720 mW	5.6 mW/°C	634 mW	547 mW	317 mW
U	675 mW	5.4 mW/°C	432 mW	350 mW	135 mW

**recommended operating conditions**

	C SUFFIX		I SUFFIX		Q SUFFIX		M SUFFIX		UNIT
	MIN	MAX	MIN	MAX	MIN	MAX	MIN	MAX	
Supply voltage, $V_{DD}$	2.7	10	2.7	10	2.7	10	2.7	10	V
Input voltage range, $V_I$	$V_{DD-}$	$V_{DD+} - 0.8$	$V_{DD-}$	$V_{DD+} - 0.8$	$V_{DD-}$	$V_{DD+} - 0.8$	$V_{DD-}$	$V_{DD+} - 0.8$	V
Common-mode input voltage, $V_{IC}$	$V_{DD-}$	$V_{DD+} - 1.3$	$V_{DD-}$	$V_{DD+} - 1.3$	$V_{DD-}$	$V_{DD+} - 1.3$	$V_{DD-}$	$V_{DD+} - 1.3$	V
Operating free-air temperature, $T_A$	0	70	-40	125	-40	125	-55	125	°C



**TLV2432, TLV2432A, TLV2434, TLV2434A**  
**Advanced LinCMOS™ RAIL-TO-RAIL OUTPUT**  
**WIDE-INPUT-VOLTAGE OPERATIONAL AMPLIFIERS**

SLOS168F – NOVEMBER 1996 – REVISED MARCH 2001

**electrical characteristics at specified free-air temperature,  $V_{DD} = 3\text{ V}$  (unless otherwise noted)**

PARAMETER	TEST CONDITIONS		$T_A^\dagger$	TLV243x			UNIT
				MIN	TYP	MAX	
$V_{IO}$ Input offset voltage	$V_{IC} = 0,$ $V_O = 0,$ $V_{DD} \pm \pm 1.5\text{ V},$ $R_S = 50\ \Omega$	TLV243xC, TLV243xI	25°C	300	2000	$\mu\text{V}$	
			Full range	2500			
		TLV243xAI	25°C	300	950		
			Full range	1500			
$\alpha_{V_{IO}}$ Temperature coefficient of input offset voltage	$V_{IC} = 0,$ $V_O = 0,$ $V_{DD} \pm \pm 1.5\text{ V},$ $R_S = 50\ \Omega$		25°C to 70°C	2		$\mu\text{V}/^\circ\text{C}$	
Input offset voltage long-term drift (see Note 4)			25°C	0.003		$\mu\text{V}/\text{mo}$	
$I_{IO}$ Input offset current			25°C	0.5	60	$\text{pA}$	
			Full range	150			
$I_{IB}$ Input bias current	25°C	1	60	$\text{pA}$			
	Full range	150					
$V_{ICR}$ Common-mode input voltage range	$ V_{IO}  \leq 5\text{ mV},$ $R_S = 50\ \Omega$		25°C	0 to 2.5	-0.25 to 2.75	$\text{V}$	
			Full range	0 to 2.2			
$V_{OH}$ High-level output voltage	$I_{OH} = -100\ \mu\text{A}$		25°C	2.98		$\text{V}$	
			25°C	2.5			
			Full range	2.25			
$V_{OL}$ Low-level output voltage	$V_{IC} = 1.5\text{ V},$ $I_{OL} = 100\ \mu\text{A}$		25°C	0.02		$\text{V}$	
			25°C	0.83			
	$V_{IC} = 1.5\text{ V},$ $I_{OL} = 3\text{ mA}$	Full range	1				
$A_{VD}$ Large-signal differential voltage amplification	$V_{IC} = 2.5\text{ V},$ $V_O = 1\text{ V to }2\text{ V}$	$R_L = 2\text{ k}\Omega^\ddagger$	25°C	1.5	2.5	$\text{V/mV}$	
			Full range	1			
		$R_L = 1\text{ M}\Omega^\ddagger$	25°C	750			
$r_{i(d)}$ Differential input resistance			25°C	1000		$\text{G}\Omega$	
$r_{i(c)}$ Common-mode input resistance			25°C	1000		$\text{G}\Omega$	
$c_{i(c)}$ Common-mode input capacitance	$f = 10\text{ kHz}$		25°C	8		$\text{pF}$	
$z_o$ Closed-loop output impedance	$f = 100\text{ kHz},$ $A_V = 10$		25°C	130		$\Omega$	
CMRR Common-mode rejection ratio	$V_{IC} = 0\text{ to }2.5\text{ V},$ $V_O = 1.5\text{ V},$ $R_S = 50\ \Omega$		25°C	70	83	$\text{dB}$	
			Full range	70			
$k_{SVR}$ Supply-voltage rejection ratio ( $\Delta V_{DD}/\Delta V_{IO}$ )	$V_{DD} = 2.7\text{ V to }8\text{ V},$ $V_{IC} = V_{DD}/2,$ No load		25°C	80	95	$\text{dB}$	
			Full range	80			
$I_{DD}$ Supply current (per channel)	$V_O = 1.5\text{ V},$ No load		25°C	98	125	$\mu\text{A}$	
			Full range	125			

$^\dagger$  Full range for the C suffix is 0°C to 70°C. Full range for the dual I suffix is -40°C to 85°C. Full range for the quad I suffix is -40°C to 125°C.

$^\ddagger$  Referenced to 2.5 V

NOTE 4: Typical values are based on the input offset voltage shift observed through 500 hours of operating life test at  $T_A = 150^\circ\text{C}$  extrapolated to  $T_A = 25^\circ\text{C}$  using the Arrhenius equation and assuming an activation energy of 0.96 eV.

**TLV2432, TLV2432A, TLV2434, TLV2434A**  
**Advanced LinCMOS™ RAIL-TO-RAIL OUTPUT**  
**WIDE-INPUT-VOLTAGE OPERATIONAL AMPLIFIERS**

SLOS168F – NOVEMBER 1996 – REVISED MARCH 2001

**operating characteristics at specified free-air temperature,  $V_{DD} = 3\text{ V}$**

PARAMETER	TEST CONDITIONS	$T_A$ †	TLV243x			UNIT
			MIN	TYP	MAX	
SR Slew rate at unity gain	$V_O = 1\text{ V to }2\text{ V},$ $C_L = 100\text{ pF}‡$	$R_L = 2\text{ k}\Omega‡,$	25°C	0.15	0.25	V/ $\mu\text{s}$
			Full range	0.1		
$V_n$ Equivalent input noise voltage	$f = 10\text{ Hz}$	25°C	120		nV/ $\sqrt{\text{Hz}}$	
	$f = 1\text{ kHz}$	25°C	22			
$V_{N(PP)}$ Peak-to-peak equivalent input noise voltage	$f = 0.1\text{ Hz to }1\text{ Hz}$	25°C	2.7		$\mu\text{V}$	
	$f = 0.1\text{ Hz to }10\text{ Hz}$	25°C	4			
$I_n$ Equivalent input noise current		25°C	0.6		fA/ $\sqrt{\text{Hz}}$	
THD + N Total harmonic distortion plus noise	$V_O = 0.5\text{ V to }2.5\text{ V},$ $f = 1\text{ kHz},$ $R_L = 2\text{ k}\Omega‡$	$A_V = 1$	0.065%			
		$A_V = 10$	0.5%			
Gain-bandwidth product	$f = 10\text{ kHz},$ $C_L = 100\text{ pF}‡$	$R_L = 2\text{ k}\Omega‡,$	25°C	0.5		MHz
BOM Maximum output-swing bandwidth	$V_{O(PP)} = 1\text{ V},$ $R_L = 2\text{ k}\Omega‡,$	$A_V = 1,$ $C_L = 100\text{ pF}‡$	25°C	220		kHz
$t_s$ Settling time	$A_V = -1,$ Step = 0.5 V to 2.5 V, $R_L = 2\text{ k}\Omega‡,$ $C_L = 100\text{ pF}‡$	To 0.1%	25°C	6.4		$\mu\text{s}$
		To 0.01%		14.1		
$\phi_m$ Phase margin at unity gain	$R_L = 2\text{ k}\Omega‡,$	$C_L = 100\text{ pF}‡$	25°C	62°		
Gain margin			25°C	11		

† Full range for the C suffix is 0°C to 70°C. Full range for the dual I suffix is –40°C to 85°C. Full range for the quad I suffix is –40°C to 125°C.

‡ Referenced to 2.5 V



**TLV2432, TLV2432A, TLV2434, TLV2434A**  
**Advanced LinCMOS™ RAIL-TO-RAIL OUTPUT**  
**WIDE-INPUT-VOLTAGE OPERATIONAL AMPLIFIERS**

SLOS168F – NOVEMBER 1996 – REVISED MARCH 2001

**electrical characteristics at specified free-air temperature,  $V_{DD} = 3\text{ V}$  (unless otherwise noted)**

PARAMETER	TEST CONDITIONS		$T_A$ †	TLV243xQ, TLV243xM			UNIT
				MIN	TYP	MAX	
$V_{IO}$ Input offset voltage	$V_{IC} = 0,$ $V_O = 0,$ $V_{DD} \pm \pm 1.5\text{ V},$ $R_S = 50\ \Omega$	TLV243xQ, TLV243xM	25°C	300	2000	$\mu\text{V}$	
			Full range	2500			
		TLV243xAQ, TLV243xAM	25°C	300	950		
			Full range	2000			
$\alpha_{V_{IO}}$ Temperature coefficient of input offset voltage	$V_{IC} = 0,$ $V_O = 0,$ $V_{DD} \pm \pm 1.5\text{ V},$ $R_S = 50\ \Omega$		25°C to 70°C	2		$\mu\text{V}/^\circ\text{C}$	
Input offset voltage long-term drift (see Note 4)			25°C	0.003		$\mu\text{V}/\text{mo}$	
$I_{IO}$ Input offset current			25°C	0.5	60	$\text{pA}$	
			Full range	150			
$I_{IB}$ Input bias current			25°C	1	60	$\text{pA}$	
			Full range	300			
$V_{ICR}$ Common-mode input voltage range	$ V_{IO}  \leq 5\text{ mV},$ $R_S = 50\ \Omega$		25°C	0 to 2.5	-0.25 to 2.75	V	
			Full range	0 to 2.2			
$V_{OH}$ High-level output voltage	$I_{OH} = -100\ \mu\text{A}$		25°C	2.98		V	
			25°C	2.5			
			Full range	2.25			
$V_{OL}$ Low-level output voltage	$V_{IC} = 1.5\text{ V},$ $I_{OL} = 100\ \mu\text{A}$		25°C	0.02		V	
			25°C	0.83			
	$V_{IC} = 1.5\text{ V},$ $I_{OL} = 3\text{ mA}$	Full range	1				
$A_{VD}$ Large-signal differential voltage amplification	$V_{IC} = 2.5\text{ V},$ $V_O = 1\text{ V to }2\text{ V}$	$R_L = 2\text{ k}\Omega^\ddagger$	25°C	1.5	2.5	V/mV	
			Full range	0.5			
		$R_L = 1\text{ M}\Omega^\ddagger$	25°C	750			
$r_{i(d)}$ Differential input resistance			25°C	1000		$\text{G}\Omega$	
$r_{i(c)}$ Common-mode input resistance			25°C	1000		$\text{G}\Omega$	
$c_{i(c)}$ Common-mode input capacitance	$f = 10\text{ kHz}$		25°C	8		$\text{pF}$	
$z_o$ Closed-loop output impedance	$f = 100\text{ kHz},$ $A_V = 10$		25°C	130		$\Omega$	
CMRR Common-mode rejection ratio	$V_{IC} = 0\text{ to }2.5\text{ V},$ $V_O = 1.5\text{ V},$ $R_S = 50\ \Omega$		25°C	70	83	dB	
			Full range	70			
$k_{SVR}$ Supply-voltage rejection ratio ( $\Delta V_{DD}/\Delta V_{IO}$ )	$V_{DD} = 2.7\text{ V to }8\text{ V},$ $V_{IC} = V_{DD}/2,$ No load		25°C	80	95	dB	
			Full range	80			
$I_{DD}$ Supply current	$V_O = 1.5\text{ V},$ No load		25°C	195	250	$\mu\text{A}$	
			Full range	260			

† Full range is  $-40^\circ\text{C}$  to  $125^\circ\text{C}$  for Q level part,  $-55^\circ\text{C}$  to  $125^\circ\text{C}$  for M level part.

‡ Referenced to 2.5 V

NOTE 4: Typical values are based on the input offset voltage shift observed through 500 hours of operating life test at  $T_A = 150^\circ\text{C}$  extrapolated to  $T_A = 25^\circ\text{C}$  using the Arrhenius equation and assuming an activation energy of 0.96 eV.

**TLV2432, TLV2432A, TLV2434, TLV2434A**  
**Advanced LinCMOS™ RAIL-TO-RAIL OUTPUT**  
**WIDE-INPUT-VOLTAGE OPERATIONAL AMPLIFIERS**

SLOS168F – NOVEMBER 1996 – REVISED MARCH 2001

**operating characteristics at specified free-air temperature,  $V_{DD} = 3\text{ V}$**

PARAMETER	TEST CONDITIONS	$T_A$ †	TLV243xQ, TLV243xM, TLV243xAQ, TLV243xAM			UNIT
			MIN	TYP	MAX	
SR Slew rate at unity gain	$V_O = 1\text{ V to }2\text{ V},$ $C_L = 100\text{ pF}‡$ $R_L = 2\text{ k}\Omega‡$	25°C	0.15	0.25		V/ $\mu\text{s}$
		Full range	0.1			
$V_n$ Equivalent input noise voltage	$f = 10\text{ Hz}$	25°C	120		nV/ $\sqrt{\text{Hz}}$	
	$f = 1\text{ kHz}$	25°C	22			
$V_N(\text{PP})$ Peak-to-peak equivalent input noise voltage	$f = 0.1\text{ Hz to }1\text{ Hz}$	25°C	2.7		$\mu\text{V}$	
	$f = 0.1\text{ Hz to }10\text{ Hz}$	25°C	4			
$I_n$ Equivalent input noise current		25°C	0.6		fA/ $\sqrt{\text{Hz}}$	
THD + N Total harmonic distortion plus noise	$V_O = 0.5\text{ V to }2.5\text{ V},$ $f = 1\text{ kHz},$ $R_L = 2\text{ k}\Omega‡$	25°C	$A_V = 1$	0.065%		
			$A_V = 10$	0.5%		
Gain-bandwidth product	$f = 10\text{ kHz},$ $C_L = 100\text{ pF}‡$ $R_L = 2\text{ k}\Omega‡$	25°C	0.5		MHz	
BOM Maximum output-swing bandwidth	$V_O(\text{PP}) = 1\text{ V},$ $R_L = 2\text{ k}\Omega‡$ $A_V = 1,$ $C_L = 100\text{ pF}‡$	25°C	220		kHz	
$t_s$ Settling time	$A_V = -1,$ Step = 0.5 V to 2.5 V, $R_L = 2\text{ k}\Omega‡$ $C_L = 100\text{ pF}‡$	25°C	To 0.1%	6.4		$\mu\text{s}$
			To 0.01%	14.1		
$\phi_m$ Phase margin at unity gain	$R_L = 2\text{ k}\Omega‡$ $C_L = 100\text{ pF}‡$	25°C	62°			
Gain margin		25°C	11		dB	

† Full range is -40°C to 125°C for Q level part, -55°C to 125°C for M level part.

‡ Referenced to 2.5 V



**TLV2432, TLV2432A, TLV2434, TLV2434A**  
**Advanced LinCMOS™ RAIL-TO-RAIL OUTPUT**  
**WIDE-INPUT-VOLTAGE OPERATIONAL AMPLIFIERS**

SLOS168F – NOVEMBER 1996 – REVISED MARCH 2001

**electrical characteristics at specified free-air temperature,  $V_{DD} = 5\text{ V}$  (unless otherwise noted)**

PARAMETER	TEST CONDITIONS		$T_A^\dagger$	TLV243x			UNIT
				MIN	TYP	MAX	
$V_{IO}$ Input offset voltage	$V_{IC} = 0,$ $V_O = 0,$ $V_{DD} \pm \pm 2.5\text{ V},$ $R_S = 50\ \Omega$	TLV243x	25°C	300	2000	$\mu\text{V}$	
			Full range	2500			
		TLV243xA	25°C	300	950		
			Full range	1500			
$\alpha_{V_{IO}}$ Temperature coefficient of input offset voltage	$V_{IC} = 0,$ $V_O = 0,$ $V_{DD} \pm \pm 2.5\text{ V},$ $R_S = 50\ \Omega$		25°C to 70°C	2		$\mu\text{V}/^\circ\text{C}$	
Input offset voltage long-term drift (see Note 4)			25°C	0.003		$\mu\text{V}/\text{mo}$	
$I_{IO}$ Input offset current			25°C	0.5	60	$\text{pA}$	
			Full range	150			
$I_{IB}$ Input bias current			25°C	1	60	$\text{pA}$	
			Full range	150			
$V_{ICR}$ Common-mode input voltage range	$ V_{IO}  \leq 5\text{ mV},$ $R_S = 50\ \Omega$		25°C	0 to 4.5	-0.25 to 4.75	$\text{V}$	
			Full range	0 to 4.2			
$V_{OH}$ High-level output voltage	$I_{OH} = -100\ \mu\text{A}$		25°C	4.97		$\text{V}$	
			25°C	$I_{OH} = -5\text{ mA}$	4		4.35
					Full range		4
$V_{OL}$ Low-level output voltage	$V_{IC} = 2.5\text{ V},$ $I_{OL} = 100\ \mu\text{A}$		25°C	0.01		$\text{V}$	
			25°C	0.8			
	$V_{IC} = 2.5\text{ V},$ $I_{OL} = 5\text{ mA}$	Full range	1.25				
$A_{VD}$ Large-signal differential voltage amplification	$V_{IC} = 2.5\text{ V},$ $V_O = 1\text{ V to }4\text{ V}$	$R_L = 2\text{ k}\Omega^\ddagger$	25°C	2.5	3.8	$\text{V/mV}$	
			Full range	1.5			
		$R_L = 1\text{ M}\Omega^\ddagger$	25°C	950			
$r_{i(d)}$ Differential input resistance			25°C	1000		$\text{G}\Omega$	
$r_{i(c)}$ Common-mode input resistance			25°C	1000		$\text{G}\Omega$	
$c_{i(c)}$ Common-mode input capacitance	$f = 10\text{ kHz}$		25°C	8		$\text{pF}$	
$z_o$ Closed-loop output impedance	$f = 100\text{ kHz},$ $A_V = 10$		25°C	130		$\Omega$	
CMRR Common-mode rejection ratio	$V_{IC} = 0\text{ to }4.5\text{ V},$ $V_O = 2.5\text{ V},$ $R_S = 50\ \Omega$		25°C	70	90	$\text{dB}$	
			Full range	70			
$k_{SVR}$ Supply-voltage rejection ratio ( $\Delta V_{DD}/\Delta V_{IO}$ )	$V_{DD} = 4.4\text{ V to }8\text{ V},$ $V_{IC} = V_{DD}/2,$ No load		25°C	80	95	$\text{dB}$	
			Full range	80			
$I_{DD}$ Supply current (per channel)	$V_O = 2.5\text{ V},$ No load		25°C	100	125	$\mu\text{A}$	
			Full range	125			

$^\dagger$  Full range for the C suffix is 0°C to 70°C. Full range for the dual I suffix is -40°C to 85°C. Full range for the quad I suffix is -40°C to 125°C.

$^\ddagger$  Referenced to 2.5 V

NOTE 4: Typical values are based on the input offset voltage shift observed through 500 hours of operating life test at  $T_A = 150^\circ\text{C}$  extrapolated to  $T_A = 25^\circ\text{C}$  using the Arrhenius equation and assuming an activation energy of 0.96 eV.

**TLV2432, TLV2432A, TLV2434, TLV2434A**  
**Advanced LinCMOS™ RAIL-TO-RAIL OUTPUT**  
**WIDE-INPUT-VOLTAGE OPERATIONAL AMPLIFIERS**

SLOS168F – NOVEMBER 1996 – REVISED MARCH 2001

**operating characteristics at specified free-air temperature,  $V_{DD} = 5\text{ V}$**

PARAMETER	TEST CONDITIONS	$T_A$ †	TLV243x			UNIT
			MIN	TYP	MAX	
SR Slew rate at unity gain	$V_O = 1.5\text{ V to }3.5\text{ V}, R_L = 2\text{ k}\Omega\ddagger, C_L = 100\text{ pF}\ddagger$	25°C	0.15	0.25		V/ $\mu\text{s}$
		Full range	0.1			
$V_n$ Equivalent input noise voltage	$f = 10\text{ Hz}$	25°C	100		nV/ $\sqrt{\text{Hz}}$	
	$f = 1\text{ kHz}$	25°C	18			
$V_{N(PP)}$ Peak-to-peak equivalent input noise voltage	$f = 0.1\text{ Hz to }1\text{ Hz}$	25°C	1.9		$\mu\text{V}$	
	$f = 0.1\text{ Hz to }10\text{ Hz}$	25°C	2.8			
$I_n$ Equivalent input noise current		25°C	0.6		fA/ $\sqrt{\text{Hz}}$	
THD + N Total harmonic distortion plus noise	$V_O = 1.5\text{ V to }3.5\text{ V}, f = 1\text{ kHz}, R_L = 2\text{ k}\Omega\ddagger$	$A_V = 1$	0.045%			
		$A_V = 10$	0.4%			
Gain-bandwidth product	$f = 10\text{ kHz}, R_L = 2\text{ k}\Omega\ddagger, C_L = 100\text{ pF}\ddagger$	25°C	0.55		MHz	
BOM Maximum output-swing bandwidth	$V_{O(PP)} = 2\text{ V}, R_L = 2\text{ k}\Omega\ddagger, A_V = 1, C_L = 100\text{ pF}\ddagger$	25°C	100		kHz	
$t_s$ Settling time	$A_V = -1, \text{ Step} = 1.5\text{ V to }3.5\text{ V}, R_L = 2\text{ k}\Omega\ddagger, C_L = 100\text{ pF}\ddagger$	$T_o = 0.1\%$	6.4		$\mu\text{s}$	
		$T_o = 0.01\%$	13.1			
$\phi_m$ Phase margin at unity gain	$R_L = 2\text{ k}\Omega\ddagger, C_L = 100\text{ pF}\ddagger$	25°C	66°			
Gain margin		25°C	11		dB	

† Full range for the C suffix is 0°C to 70°C. Full range for the dual I suffix is –40°C to 85°C. Full range for the quad I suffix is –40°C to 125°C.  
 ‡ Referenced to 2.5 V



**TLV2432, TLV2432A, TLV2434, TLV2434A**  
**Advanced LinCMOS™ RAIL-TO-RAIL OUTPUT**  
**WIDE-INPUT-VOLTAGE OPERATIONAL AMPLIFIERS**

SLOS168F – NOVEMBER 1996 – REVISED MARCH 2001

**electrical characteristics at specified free-air temperature,  $V_{DD} = 5\text{ V}$  (unless otherwise noted)**

PARAMETER	TEST CONDITIONS		$T_A$ †	TLV243xQ, TLV243xM			UNIT
				MIN	TYP	MAX	
$V_{IO}$ Input offset voltage	$V_{IC} = 0,$ $V_O = 0,$ $V_{DD} \pm = \pm 2.5\text{ V},$ $R_S = 50\ \Omega$	TLV2453x	25°C	300	2000	$\mu\text{V}$	
			Full range	2500			
		TLV2453xA	25°C	300	950		
			Full range	2000			
$\alpha_{V_{IO}}$ Temperature coefficient of input offset voltage			25°C to 70°C	2		$\mu\text{V}/^\circ\text{C}$	
Input offset voltage long-term drift (see Note 4)			25°C	0.003		$\mu\text{V}/\text{mo}$	
$I_{IO}$ Input offset current	$V_{IC} = 0,$ $V_O = 0,$ $V_{DD} \pm = \pm 2.5\text{ V},$ $R_S = 50\ \Omega$		25°C	0.5	60	$\text{pA}$	
			Full range	150			
$I_{IB}$ Input bias current			25°C	1	60	$\text{pA}$	
			Full range	300			
$V_{ICR}$ Common-mode input voltage range	$ V_{IO}  \leq 5\text{ mV},$ $R_S = 50\ \Omega$		25°C	0 to 4.5	-0.25 to 4.75	V	
			Full range	0 to 4.2			
$V_{OH}$ High-level output voltage	$I_{OH} = -100\ \mu\text{A}$		25°C	4.97		V	
			25°C	4	4.35		
			Full range	4			
$V_{OL}$ Low-level output voltage	$V_{IC} = 2.5\text{ V},$ $I_{OL} = 100\ \mu\text{A}$		25°C	0.01		V	
			25°C	0.8			
	$V_{IC} = 2.5\text{ V},$ $I_{OL} = 5\text{ mA}$		Full range	1.25			
$A_{VD}$ Large-signal differential voltage amplification	$V_{IC} = 2.5\text{ V},$ $V_O = 1\text{ V to }4\text{ V}$	$R_L = 2\text{ k}\Omega^\ddagger$	25°C	2.5	3.8	V/mV	
			Full range	0.5			
		$R_L = 1\text{ M}\Omega^\ddagger$	25°C	950			
$r_{i(d)}$ Differential input resistance			25°C	1000		$\text{G}\Omega$	
$r_{i(c)}$ Common-mode input resistance			25°C	1000		$\text{G}\Omega$	
$c_{i(c)}$ Common-mode input capacitance	$f = 10\text{ kHz}$		25°C	8		$\text{pF}$	
$z_o$ Closed-loop output impedance	$f = 100\text{ kHz},$ $A_V = 10$		25°C	130		$\Omega$	
CMRR Common-mode rejection ratio	$V_{IC} = 0\text{ to }4.5\text{ V},$ $V_O = 2.5\text{ V},$ $R_S = 50\ \Omega$		25°C	70	90	dB	
			Full range	70			
$k_{SVR}$ Supply-voltage rejection ratio ( $\Delta V_{DD}/\Delta V_{IO}$ )	$V_{DD} = 4.4\text{ V to }8\text{ V},$ $V_{IC} = V_{DD}/2,$ No load		25°C	80	95	dB	
			Full range	80			
$I_{DD}$ Supply current	$V_O = 2.5\text{ V},$ No load		25°C	200	250	$\mu\text{A}$	
			Full range	270			

† Full range is  $-40^\circ\text{C}$  to  $125^\circ\text{C}$  for Q level part,  $-55^\circ\text{C}$  to  $125^\circ\text{C}$  for M level part.

‡ Referenced to 2.5 V

NOTE 4: Typical values are based on the input offset voltage shift observed through 500 hours of operating life test at  $T_A = 150^\circ\text{C}$  extrapolated to  $T_A = 25^\circ\text{C}$  using the Arrhenius equation and assuming an activation energy of 0.96 eV.

**TLV2432, TLV2432A, TLV2434, TLV2434A**  
**Advanced LinCMOS™ RAIL-TO-RAIL OUTPUT**  
**WIDE-INPUT-VOLTAGE OPERATIONAL AMPLIFIERS**

SLOS168F – NOVEMBER 1996 – REVISED MARCH 2001

**operating characteristics at specified free-air temperature,  $V_{DD} = 5\text{ V}$**

PARAMETER	TEST CONDITIONS	$T_A$ †	TLV243xQ, TLV243xM, TLV243xAQ, TLV243xAM			UNIT
			MIN	TYP	MAX	
SR Slew rate at unity gain	$V_O = 1.5\text{ V to }3.5\text{ V}, R_L = 2\text{ k}\Omega\ddagger, C_L = 100\text{ pF}\ddagger$	25°C	0.15	0.25		V/ $\mu\text{s}$
		Full range	0.1			
$V_n$ Equivalent input noise voltage	$f = 10\text{ Hz}$	25°C	100		nV/ $\sqrt{\text{Hz}}$	
	$f = 1\text{ kHz}$	25°C	18			
$V_{N(PP)}$ Peak-to-peak equivalent input noise voltage	$f = 0.1\text{ Hz to }1\text{ Hz}$	25°C	1.9		$\mu\text{V}$	
	$f = 0.1\text{ Hz to }10\text{ Hz}$	25°C	2.8			
$I_n$ Equivalent input noise current		25°C	0.6		fA/ $\sqrt{\text{Hz}}$	
THD + N Total harmonic distortion plus noise	$V_O = 1.5\text{ V to }3.5\text{ V}, f = 1\text{ kHz}, R_L = 2\text{ k}\Omega\ddagger$	$A_V = 1$	0.045%			
		$A_V = 10$	0.4%			
Gain-bandwidth product	$f = 10\text{ kHz}, C_L = 100\text{ pF}\ddagger, R_L = 2\text{ k}\Omega\ddagger$	25°C	0.55		MHz	
BOM Maximum output-swing bandwidth	$V_{O(PP)} = 2\text{ V}, R_L = 2\text{ k}\Omega\ddagger, A_V = 1, C_L = 100\text{ pF}\ddagger$	25°C	100		kHz	
$t_s$ Settling time	$A_V = -1, \text{ Step} = 1.5\text{ V to }3.5\text{ V}, R_L = 2\text{ k}\Omega\ddagger, C_L = 100\text{ pF}\ddagger$	To 0.1%	6.4		$\mu\text{s}$	
		To 0.01%	13.1			
$\phi_m$ Phase margin at unity gain	$R_L = 2\text{ k}\Omega\ddagger, C_L = 100\text{ pF}\ddagger$	25°C	66°			
Gain margin		25°C	11		dB	

† Full range is  $-40^\circ\text{C}$  to  $125^\circ\text{C}$  for Q level part,  $-55^\circ\text{C}$  to  $125^\circ\text{C}$  for M level part.

‡ Referenced to 2.5 V



**TLV2432, TLV2432A, TLV2434, TLV2434A**  
**Advanced LinCMOS™ RAIL-TO-RAIL OUTPUT**  
**WIDE-INPUT-VOLTAGE OPERATIONAL AMPLIFIERS**

SLOS168F – NOVEMBER 1996 – REVISED MARCH 2001

**TYPICAL CHARACTERISTICS**

**Table of Graphs**

			<b>FIGURE</b>
$V_{IO}$	Input offset voltage	Distribution vs Common-mode input voltage	2,3 4,5
$\alpha_{VIO}$	Temperature coefficient	Distribution	6,7
$I_{IB}/I_{IO}$	Input bias and input offset currents	vs Free-air temperature	8
$V_{OH}$	High-level output voltage	vs High-level output current	9,11
$V_{OL}$	Low-level output voltage	vs Low-level output current	10,12
$V_{O(PP)}$	Maximum peak-to-peak output voltage	vs Frequency	13
$I_{OS}$	Short-circuit output current	vs Supply voltage	14
		vs Free-air temperature	15
$V_{ID}$	Differential input voltage	vs Output voltage	16,17
		Differential gain	vs Load resistance
$A_{VD}$	Large-signal differential voltage amplification	vs Frequency	19,20
$A_{VD}$	Differential voltage amplification	vs Free-air temperature	21,22
$z_o$	Output impedance	vs Frequency	23,24
CMRR	Common-mode rejection ratio	vs Frequency	25
		vs Free-air temperature	26
$k_{SVR}$	Supply-voltage rejection ratio	vs Frequency	27,28
		vs Free-air temperature	29
$I_{DD}$	Supply current	vs Supply voltage	30
SR	Slew rate	vs Load capacitance	31
		vs Free-air temperature	32
$V_O$	Inverting large-signal pulse response		33,34
$V_O$	Voltage-follower large-signal pulse response		35,36
$V_O$	Inverting small-signal pulse response		37,38
$V_O$	Voltage-follower small-signal pulse response		39,40
$V_n$	Equivalent input noise voltage	vs Frequency	41, 42
		Noise voltage (referred to input)	Over a 10-second period
THD + N	Total harmonic distortion plus noise	vs Frequency	44,45
		Gain-bandwidth product	vs Free-air temperature vs Supply voltage
$\phi_m$	Phase margin	vs Frequency	19,20
		vs Load capacitance	48
	Gain margin	vs Load capacitance	49
$B_1$	Unity-gain bandwidth	vs Load capacitance	50

**TLV2432, TLV2432A, TLV2434, TLV2434A**  
**Advanced LinCMOS™ RAIL-TO-RAIL OUTPUT**  
**WIDE-INPUT-VOLTAGE OPERATIONAL AMPLIFIERS**

SLOS168F – NOVEMBER 1996 – REVISED MARCH 2001

**TYPICAL CHARACTERISTICS**

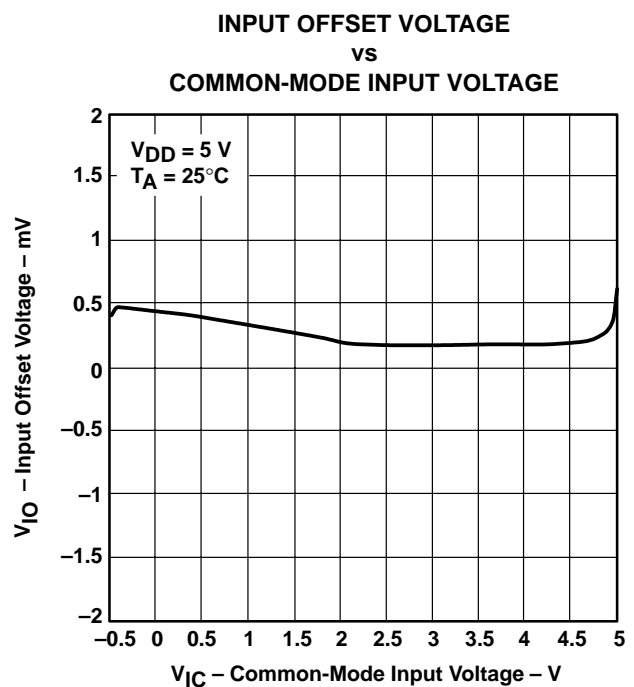
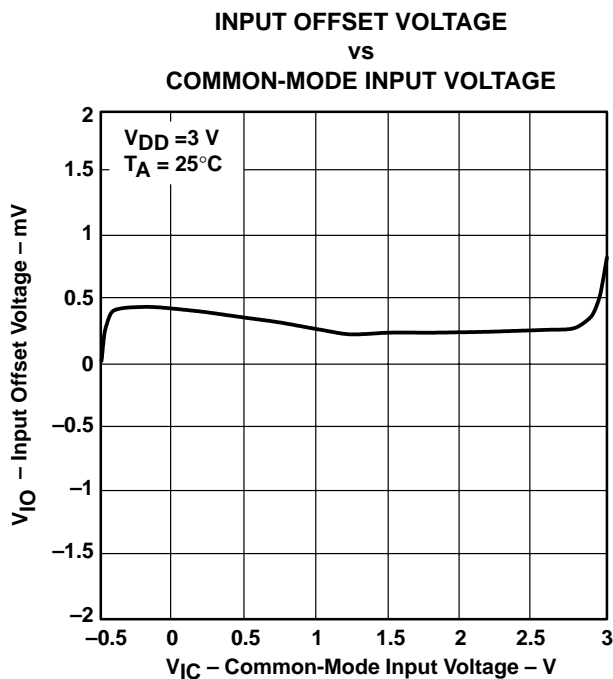
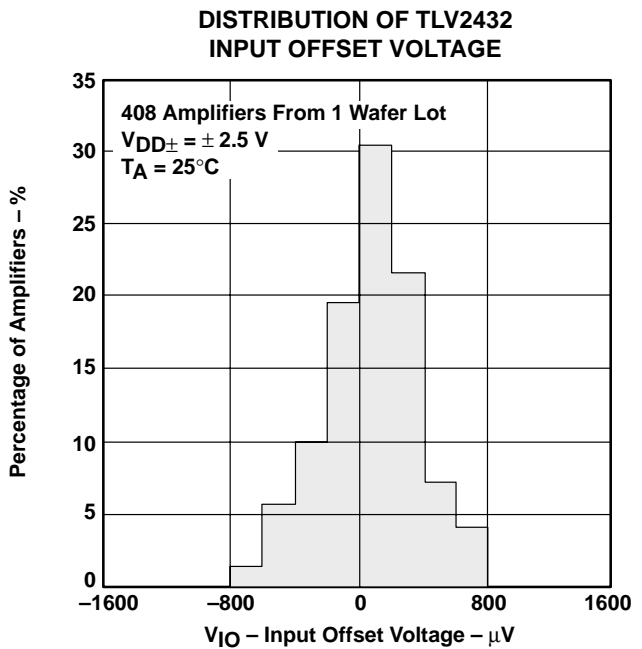
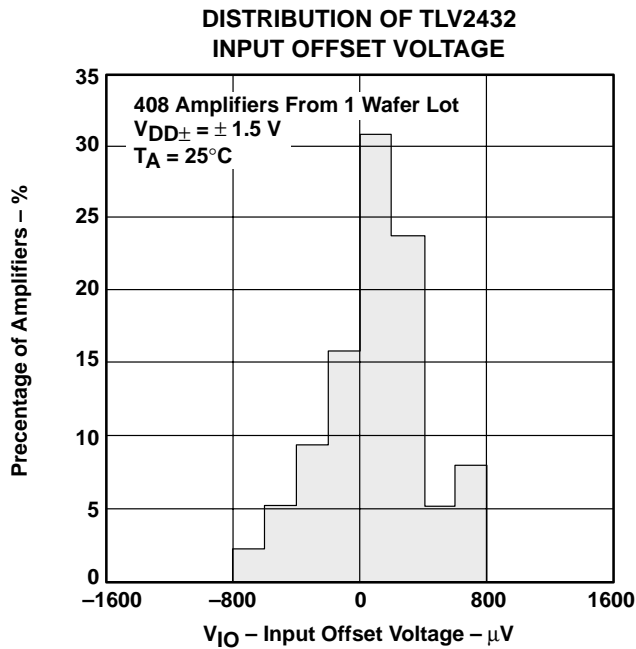

TYPICAL CHARACTERISTICS

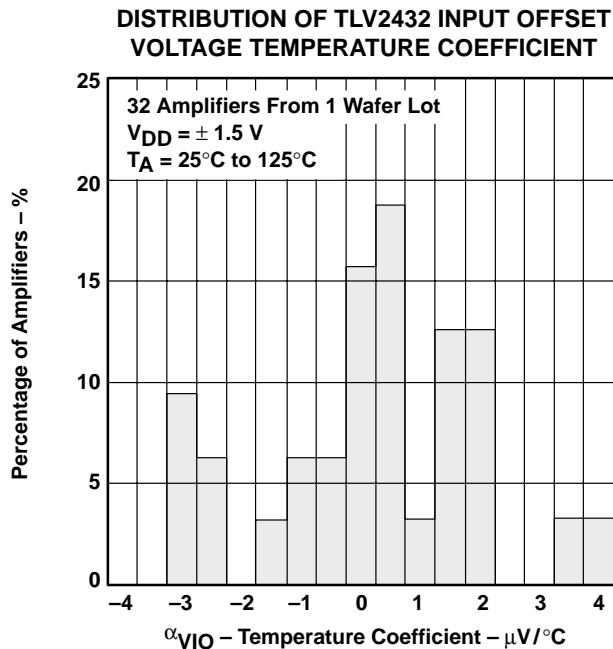

Figure 6

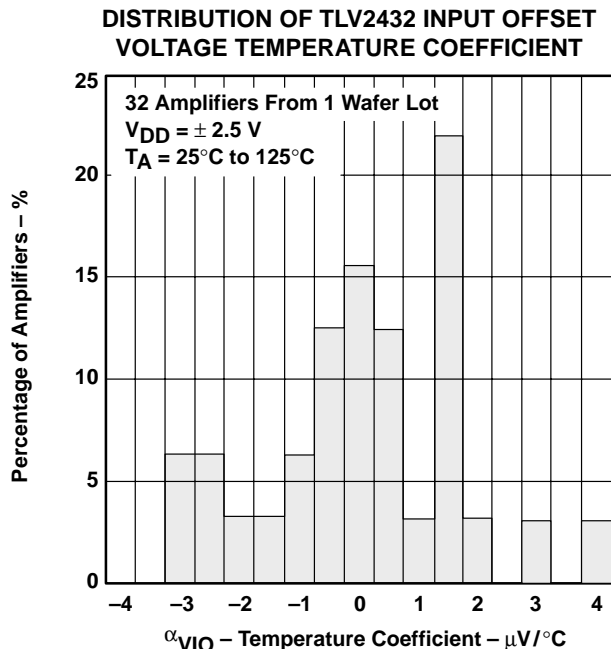

Figure 7

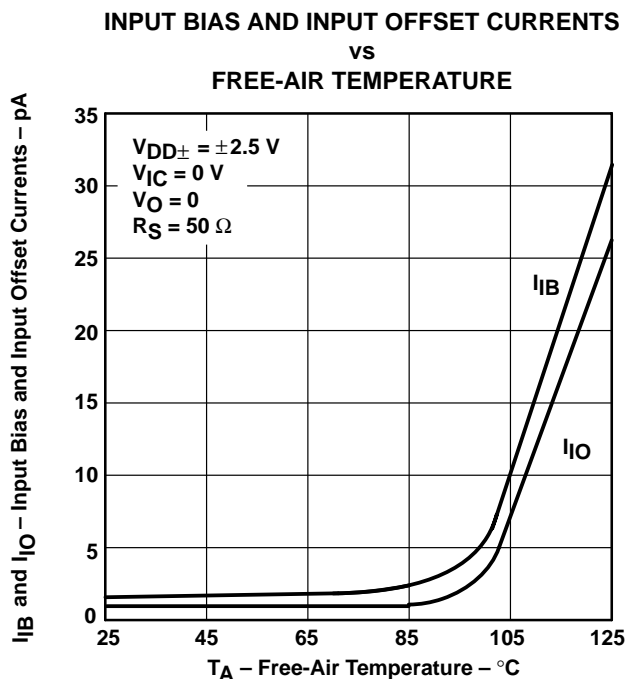

Figure 8

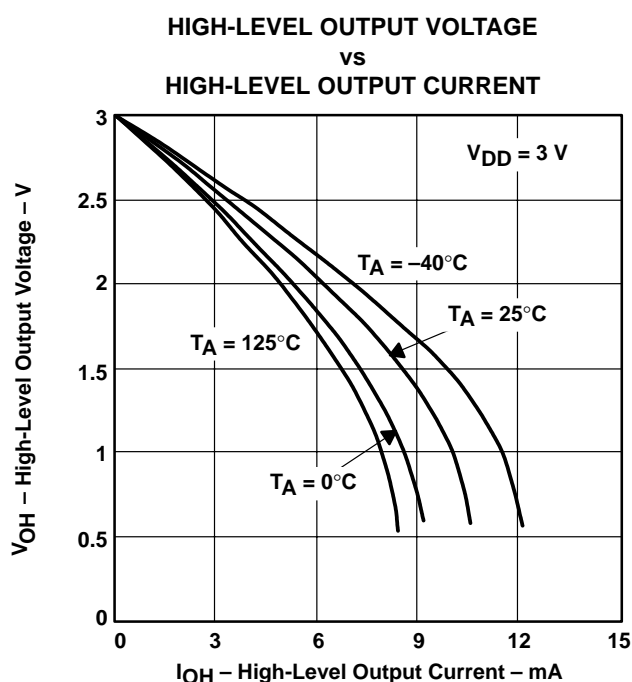
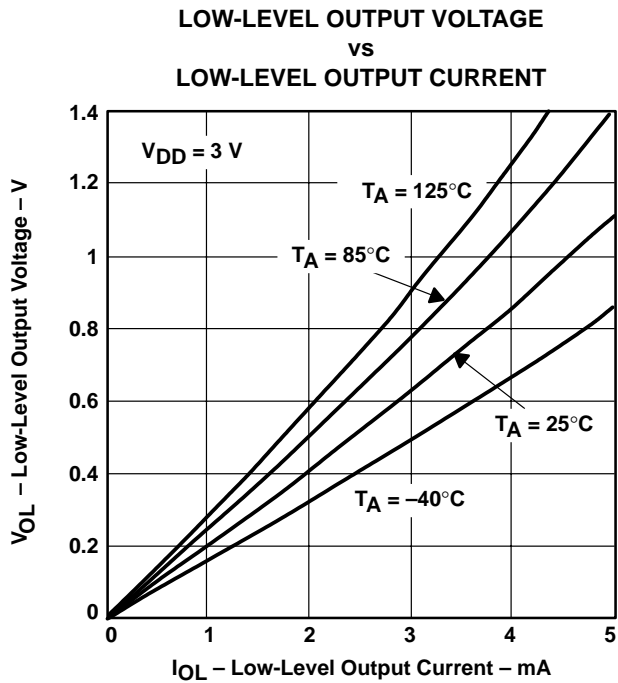

Figure 9

**TLV2432, TLV2432A, TLV2434, TLV2434A**  
**Advanced LinCMOS™ RAIL-TO-RAIL OUTPUT**  
**WIDE-INPUT-VOLTAGE OPERATIONAL AMPLIFIERS**

SLOS168F – NOVEMBER 1996 – REVISED MARCH 2001

**TYPICAL CHARACTERISTICS**



**Figure 10**

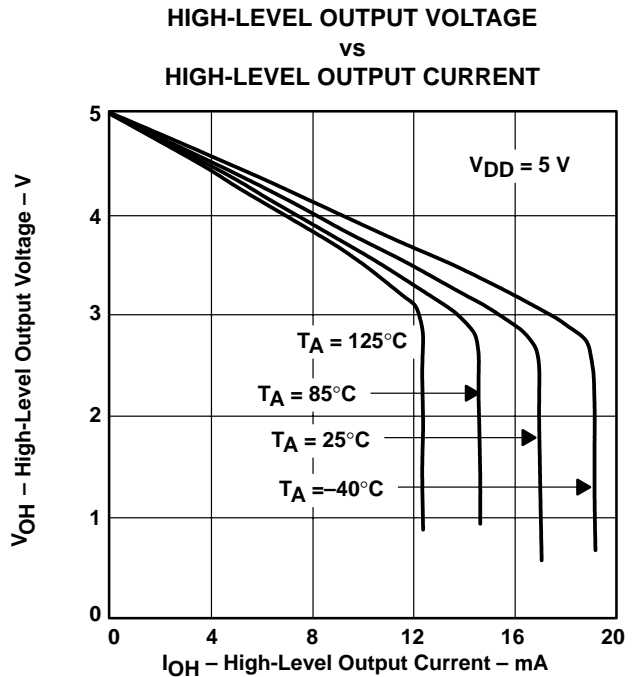

**Figure 11**

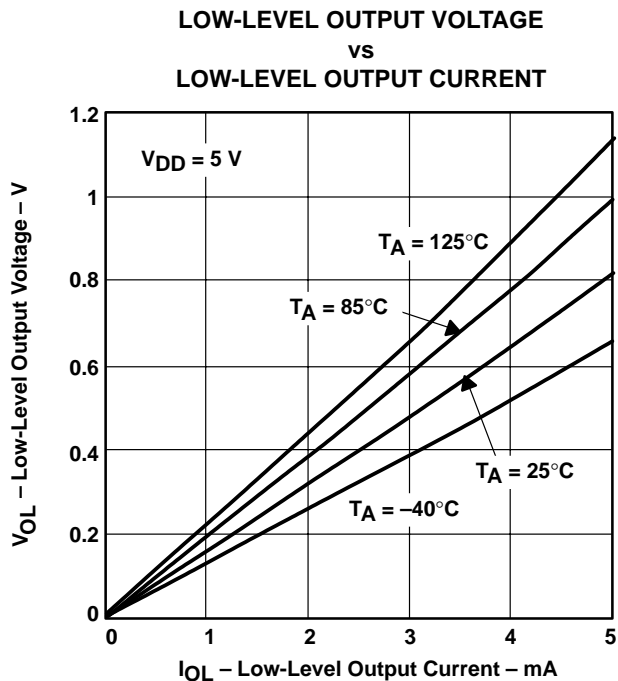

**Figure 12**

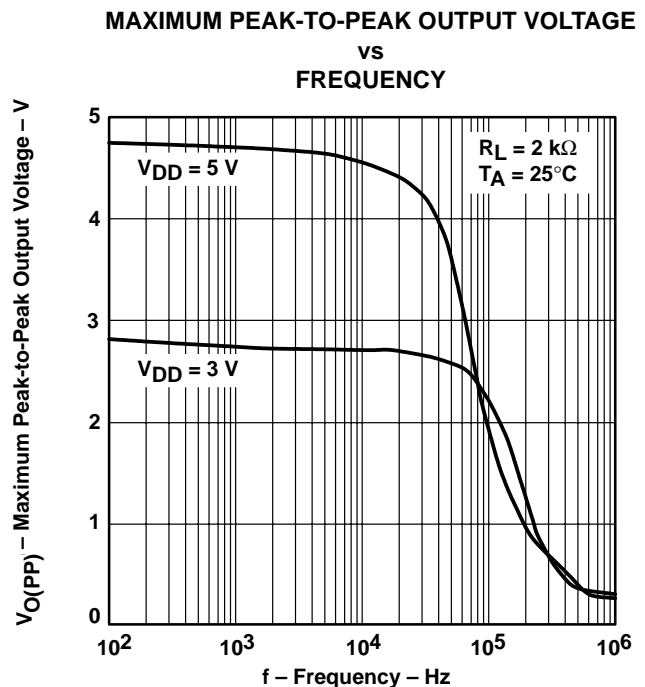

**Figure 13**



TYPICAL CHARACTERISTICS

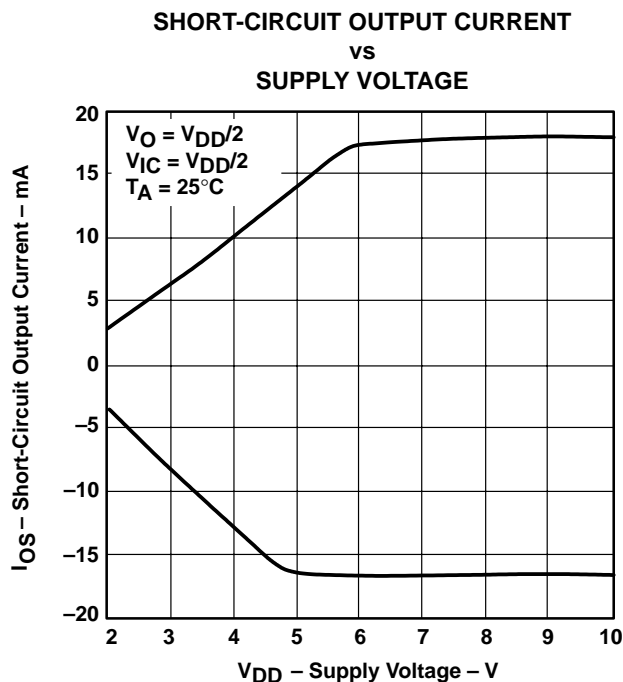

Figure 14

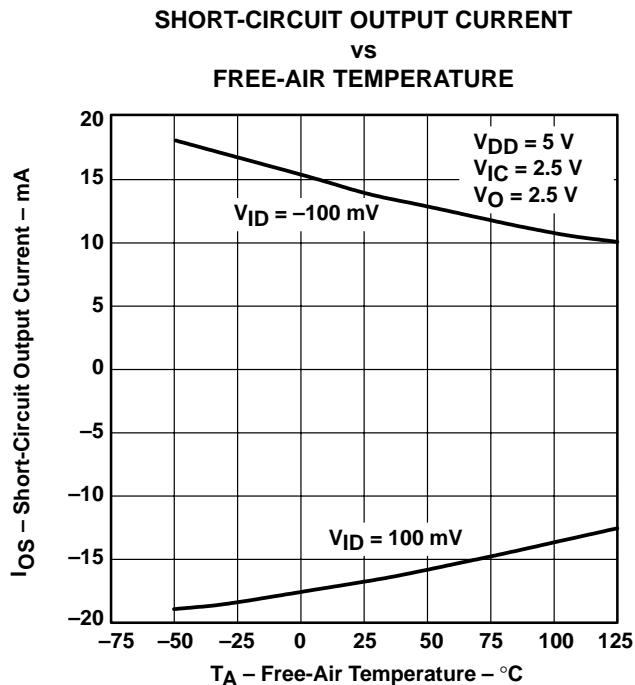

Figure 15

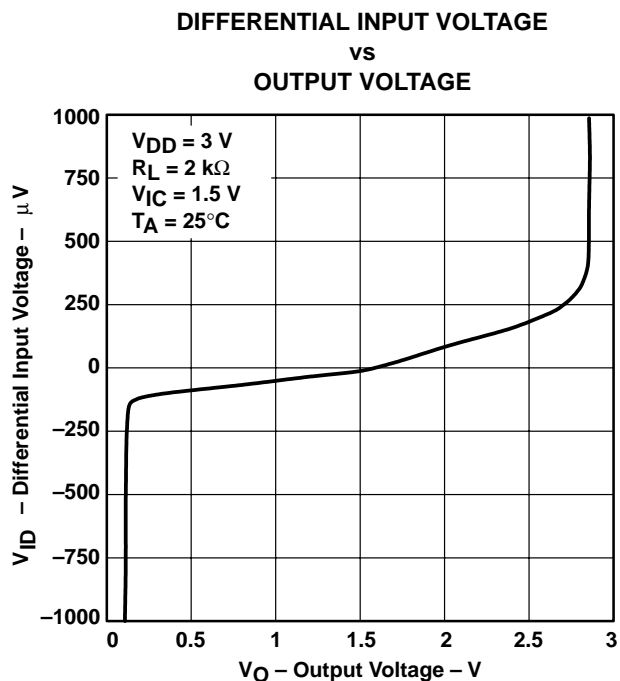

Figure 16

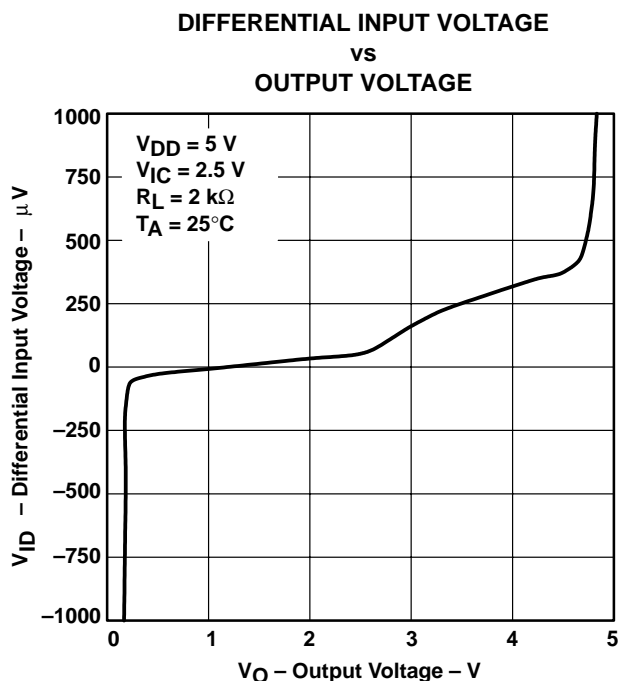
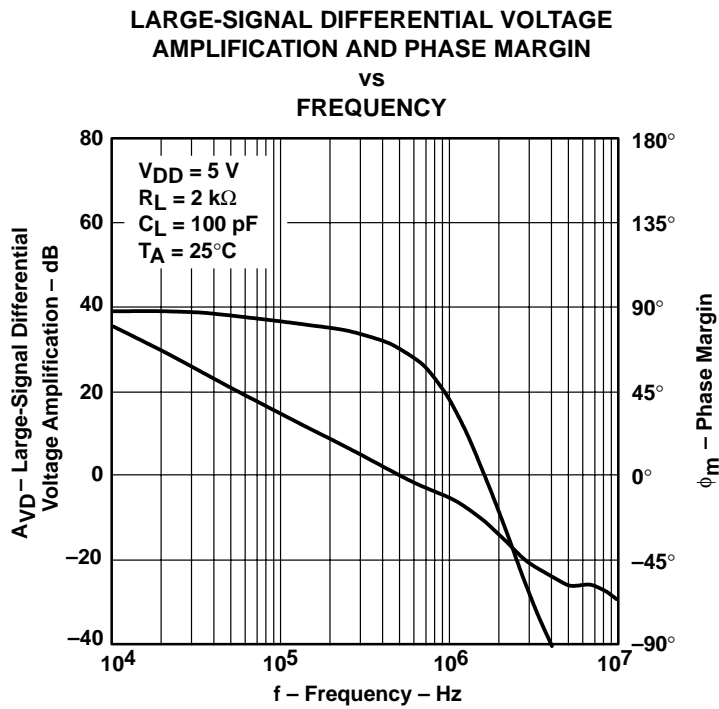
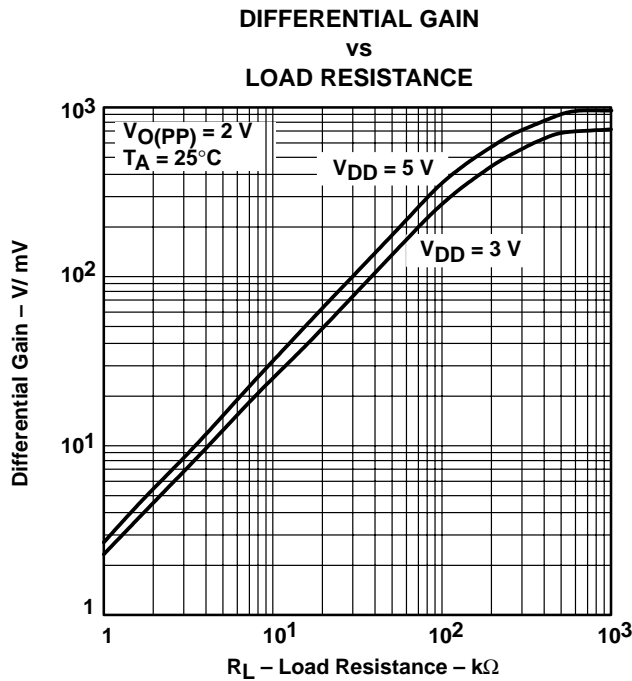

Figure 17

**TLV2432, TLV2432A, TLV2434, TLV2434A**  
**Advanced LinCMOS™ RAIL-TO-RAIL OUTPUT**  
**WIDE-INPUT-VOLTAGE OPERATIONAL AMPLIFIERS**

SLOS168F – NOVEMBER 1996 – REVISED MARCH 2001

**TYPICAL CHARACTERISTICS**



TYPICAL CHARACTERISTICS

LARGE-SIGNAL DIFFERENTIAL VOLTAGE  
 AMPLIFICATION AND PHASE MARGIN

vs  
 FREQUENCY

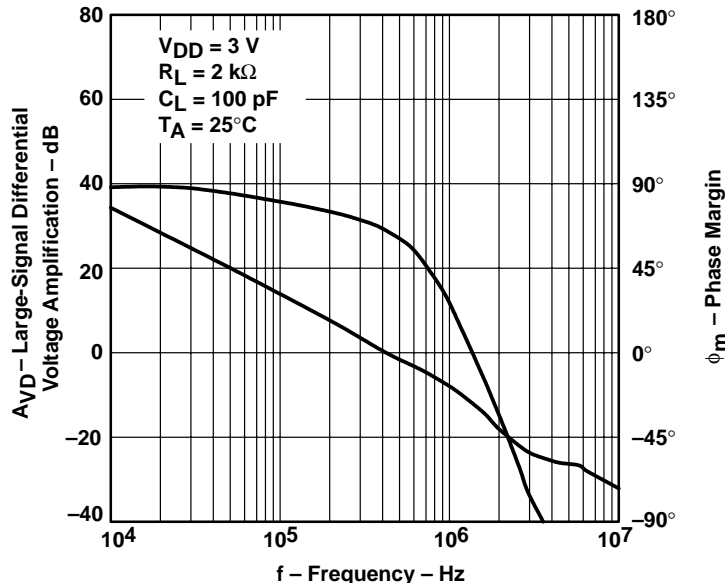

Figure 20

DIFFERENTIAL VOLTAGE AMPLIFICATION  
 vs  
 FREE-AIR TEMPERATURE

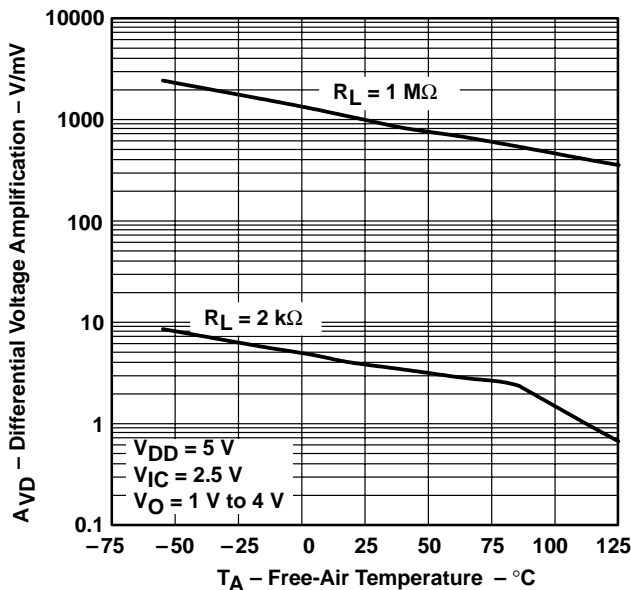

Figure 21

DIFFERENTIAL VOLTAGE AMPLIFICATION  
 vs  
 FREE-AIR TEMPERATURE

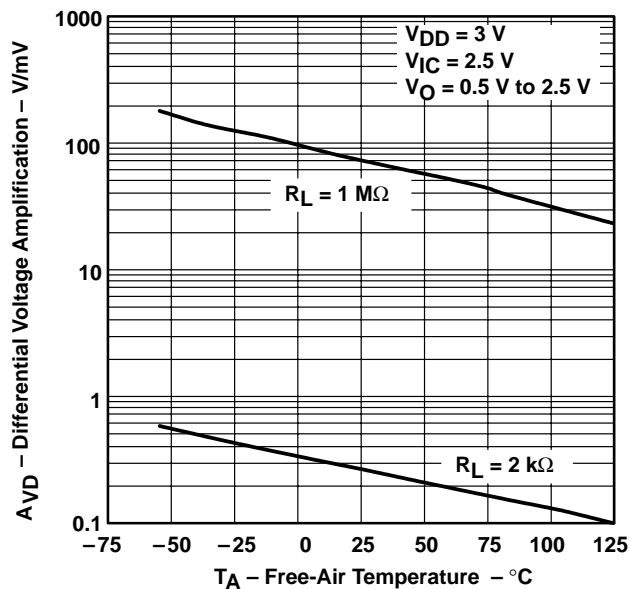

Figure 22

**TLV2432, TLV2432A, TLV2434, TLV2434A**  
**Advanced LinCMOS™ RAIL-TO-RAIL OUTPUT**  
**WIDE-INPUT-VOLTAGE OPERATIONAL AMPLIFIERS**

SLOS168F – NOVEMBER 1996 – REVISED MARCH 2001

**TYPICAL CHARACTERISTICS**

**OUTPUT IMPEDANCE**  
**VS**  
**FREQUENCY**

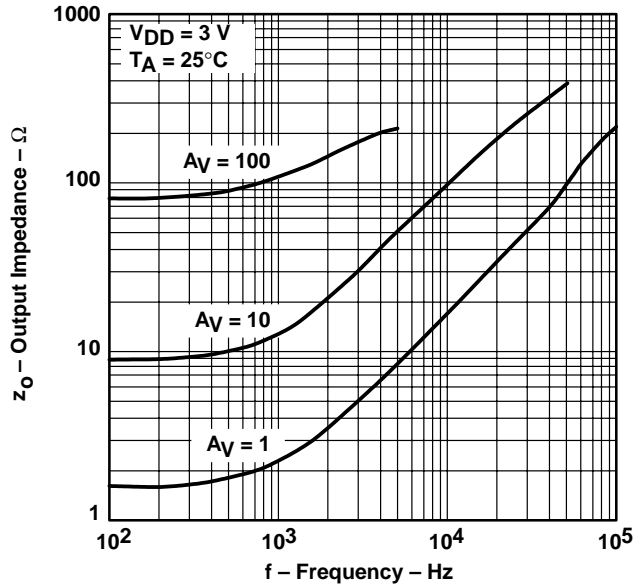

**Figure 23**

**OUTPUT IMPEDANCE**  
**VS**  
**FREQUENCY**

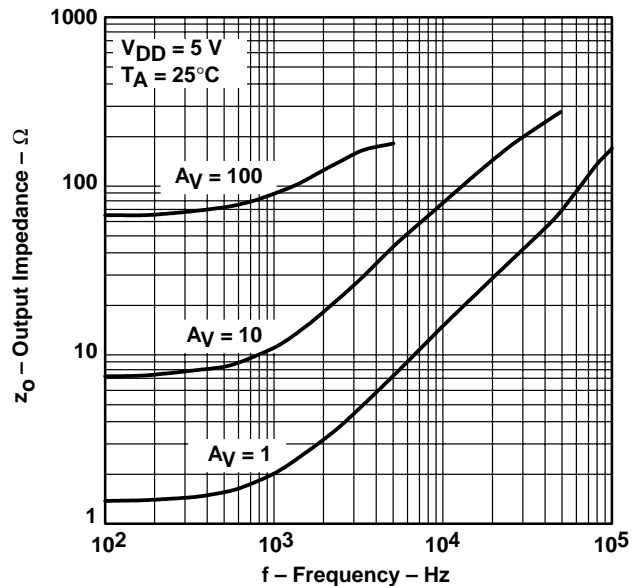

**Figure 24**

**COMMON-MODE REJECTION RATIO**  
**VS**  
**FREQUENCY**

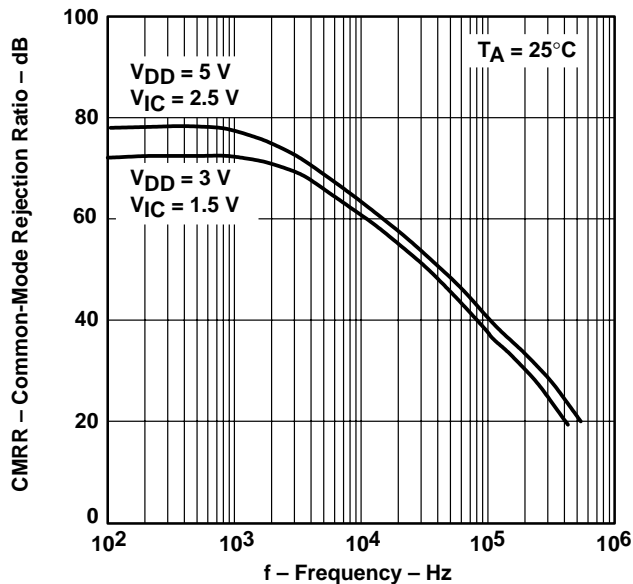

**Figure 25**

**COMMON-MODE REJECTION RATIO**  
**VS**  
**FREE-AIR TEMPERATURE**

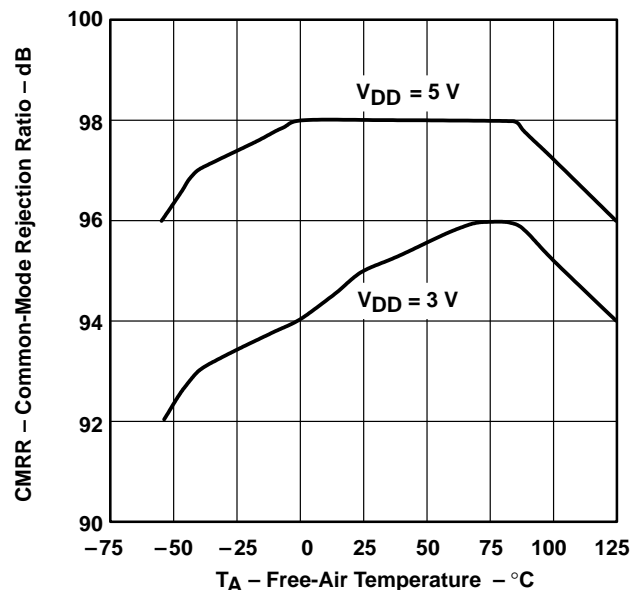

**Figure 26**



TYPICAL CHARACTERISTICS

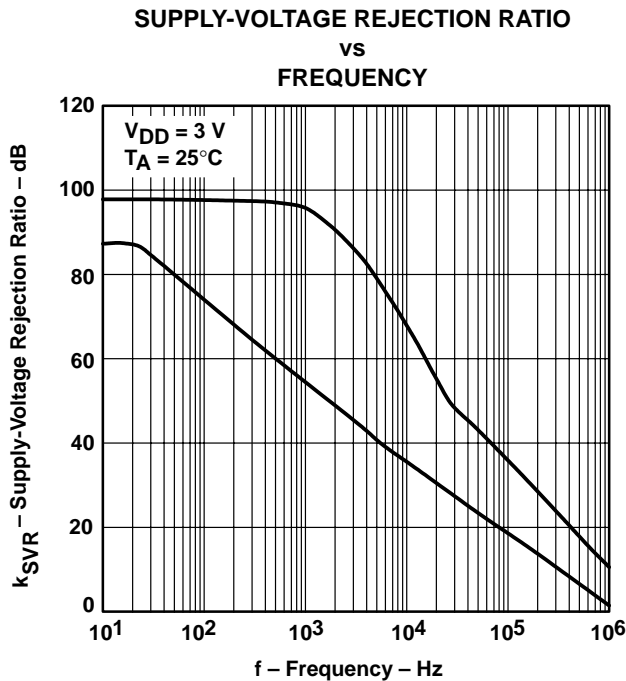

Figure 27

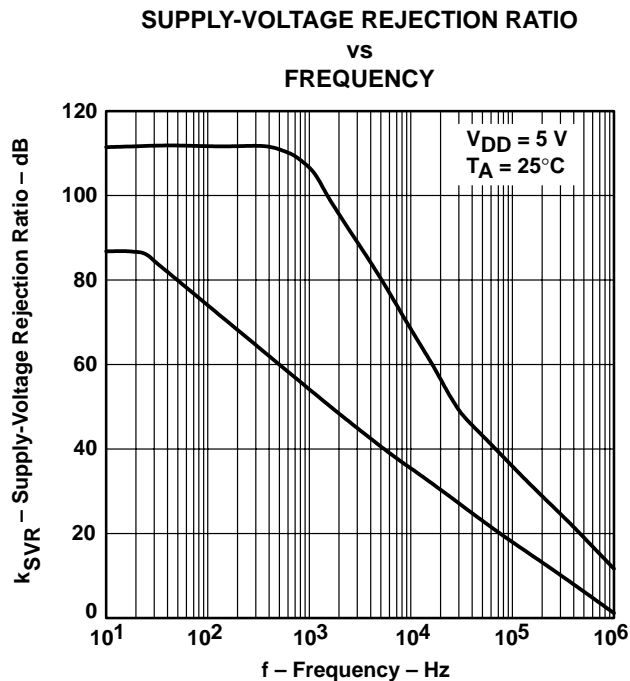

Figure 28

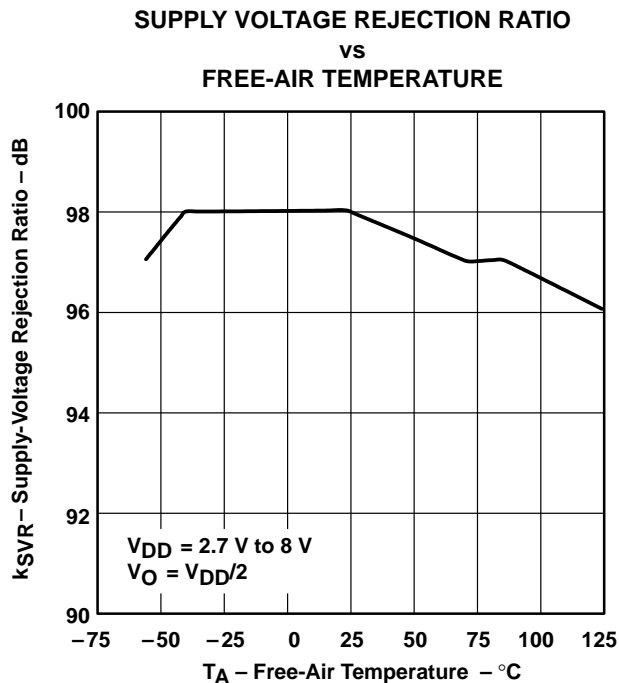

Figure 29

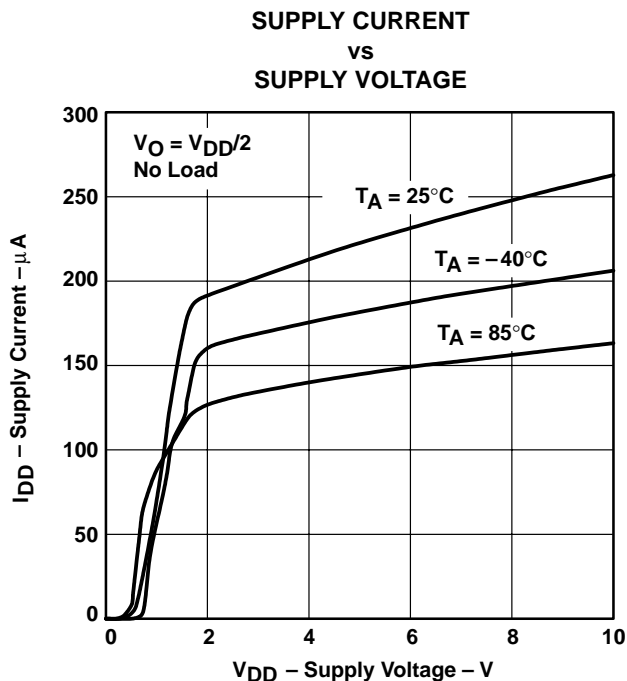
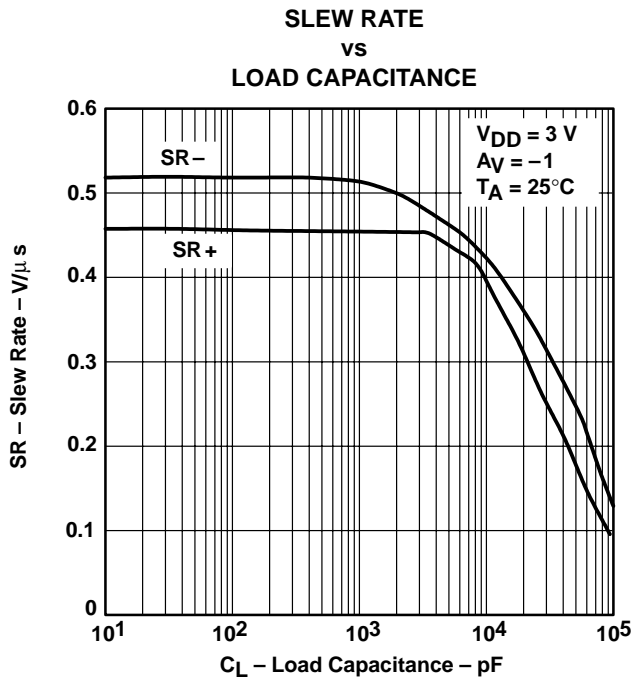

Figure 30

**TLV2432, TLV2432A, TLV2434, TLV2434A**  
**Advanced LinCMOS™ RAIL-TO-RAIL OUTPUT**  
**WIDE-INPUT-VOLTAGE OPERATIONAL AMPLIFIERS**

SLOS168F – NOVEMBER 1996 – REVISED MARCH 2001

**TYPICAL CHARACTERISTICS**



**Figure 31**

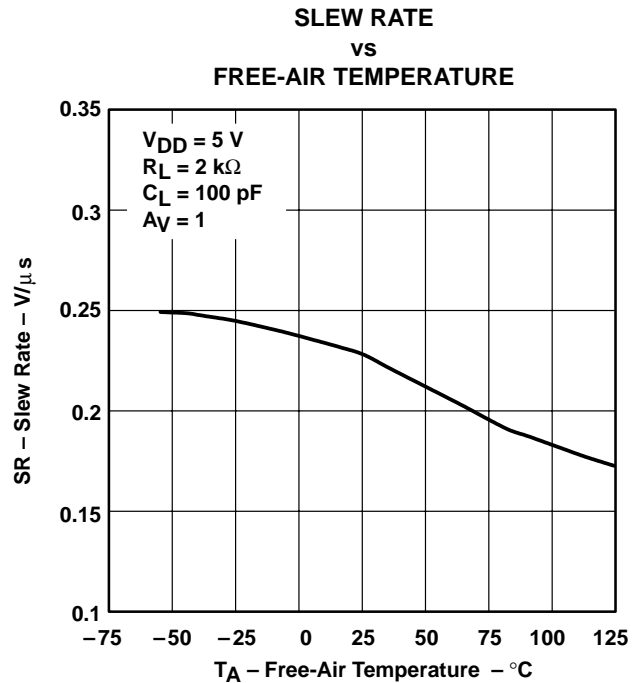

**Figure 32**

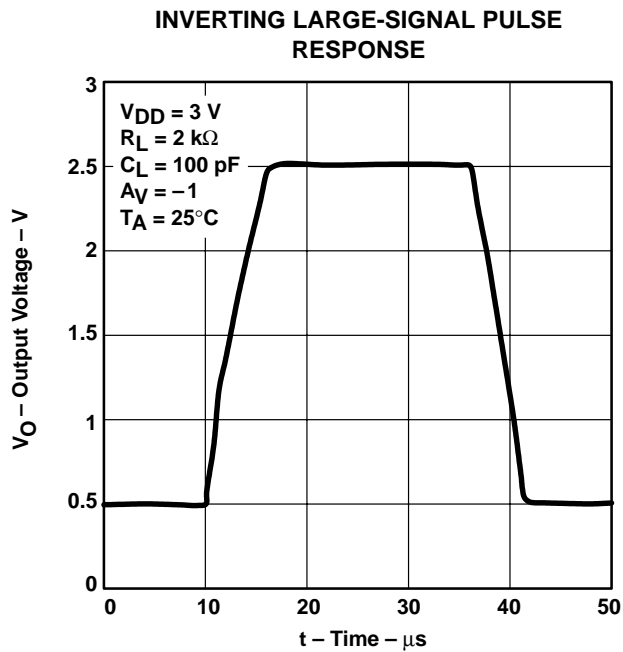

**Figure 33**

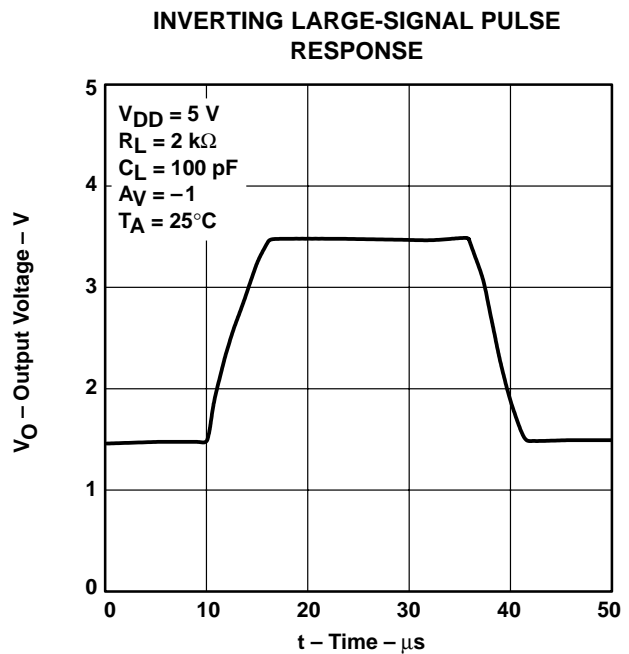

**Figure 34**

TYPICAL CHARACTERISTICS

VOLTAGE-FOLLOWER LARGE-SIGNAL PULSE RESPONSE

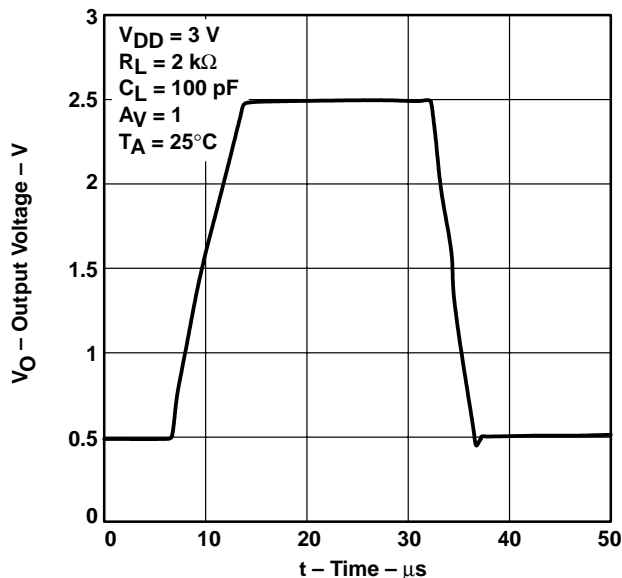

Figure 35

VOLTAGE-FOLLOWER LARGE-SIGNAL PULSE RESPONSE

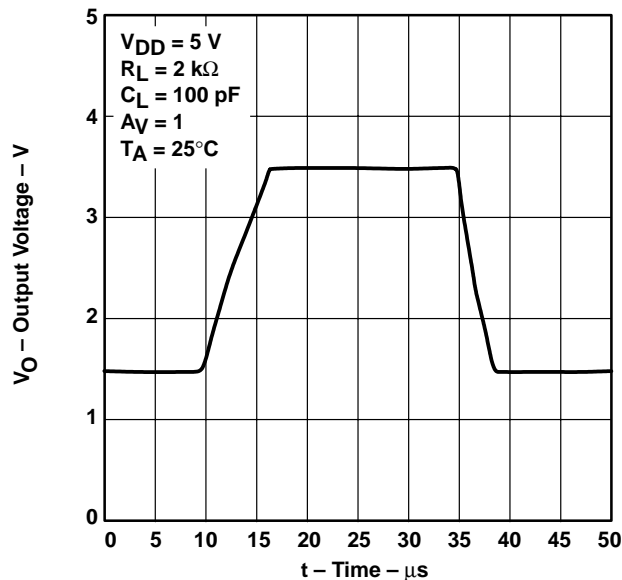

Figure 36

INVERTING SMALL-SIGNAL PULSE RESPONSE

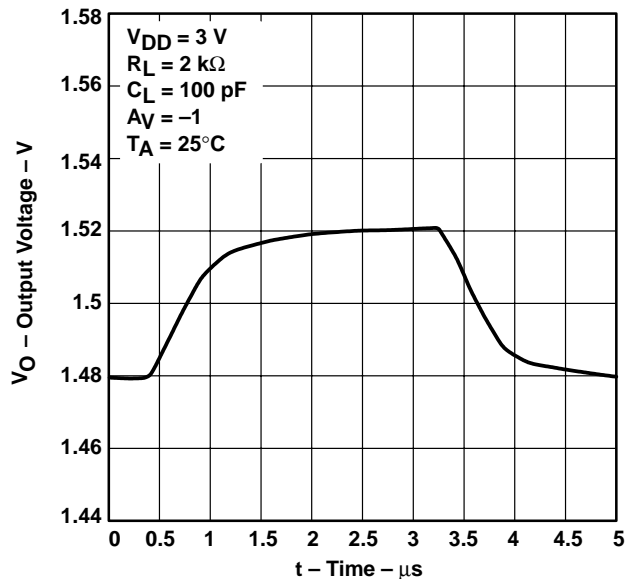

Figure 37

INVERTING SMALL-SIGNAL PULSE RESPONSE

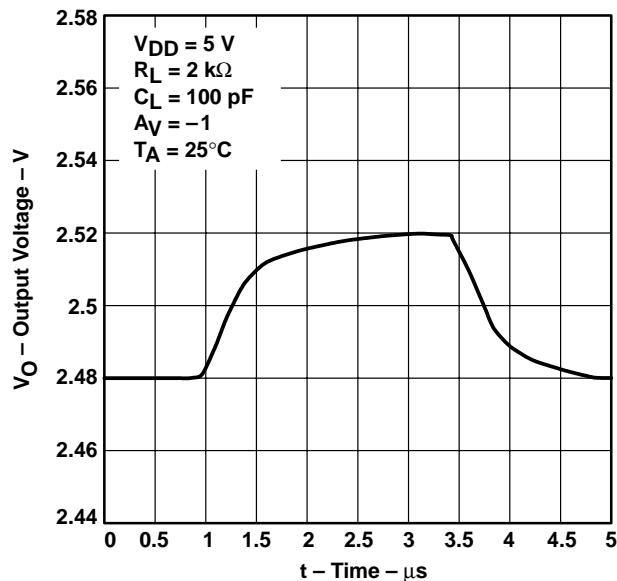

Figure 38

**TLV2432, TLV2432A, TLV2434, TLV2434A**  
**Advanced LinCMOS™ RAIL-TO-RAIL OUTPUT**  
**WIDE-INPUT-VOLTAGE OPERATIONAL AMPLIFIERS**

SLOS168F – NOVEMBER 1996 – REVISED MARCH 2001

**TYPICAL CHARACTERISTICS**

**VOLTAGE-FOLLOWER SMALL-SIGNAL PULSE RESPONSE**

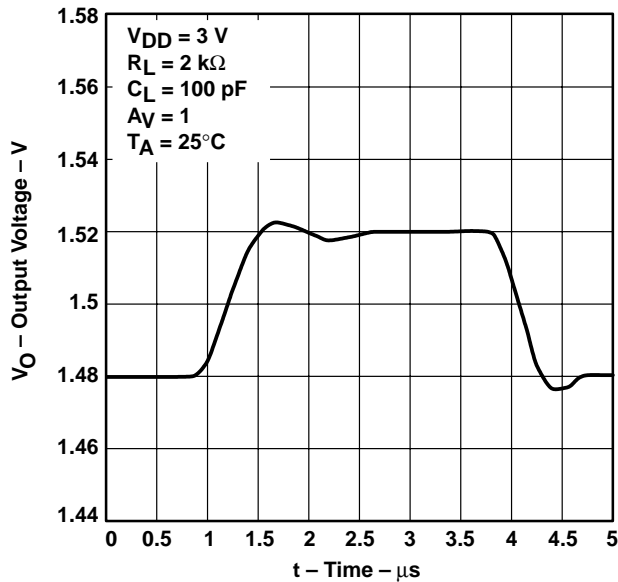

**Figure 39**

**VOLTAGE-FOLLOWER SMALL-SIGNAL PULSE RESPONSE**

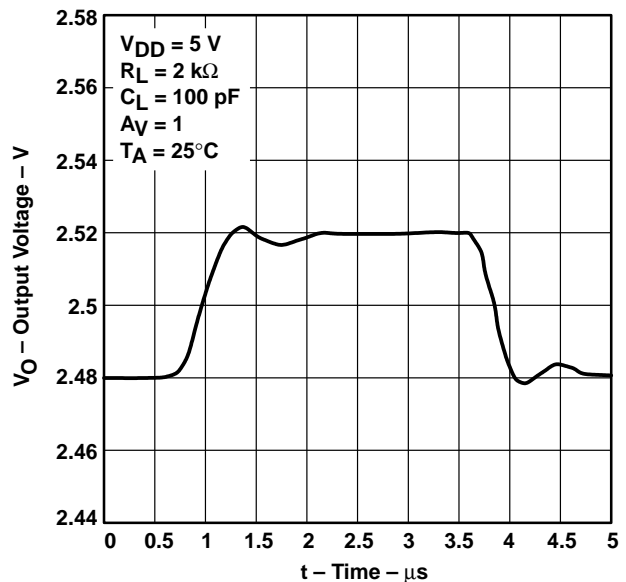

**Figure 40**

**EQUIVALENT INPUT NOISE VOLTAGE VS FREQUENCY**

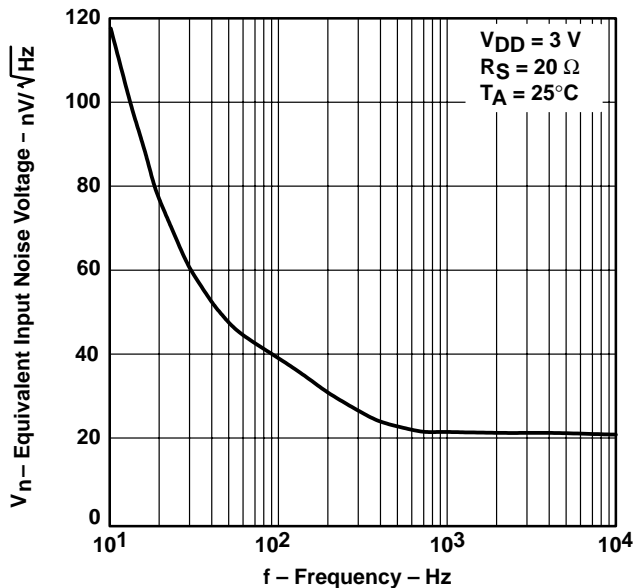

**Figure 41**

**EQUIVALENT INPUT NOISE VOLTAGE VS FREQUENCY**

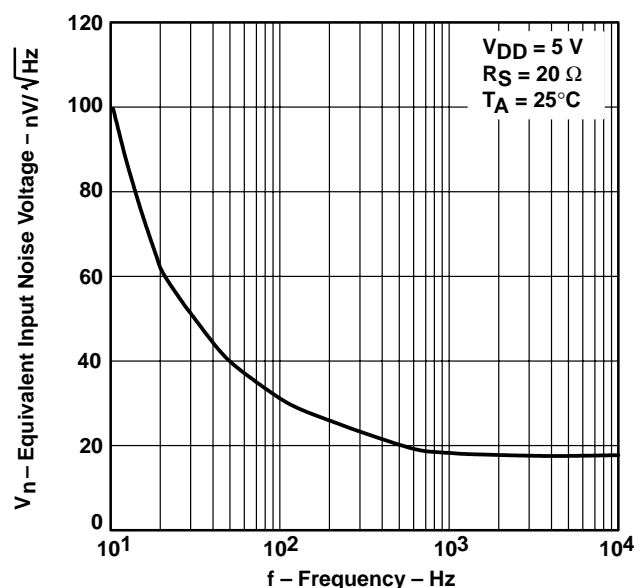

**Figure 42**



TYPICAL CHARACTERISTICS

NOISE VOLTAGE OVER A 10-SECOND PERIOD

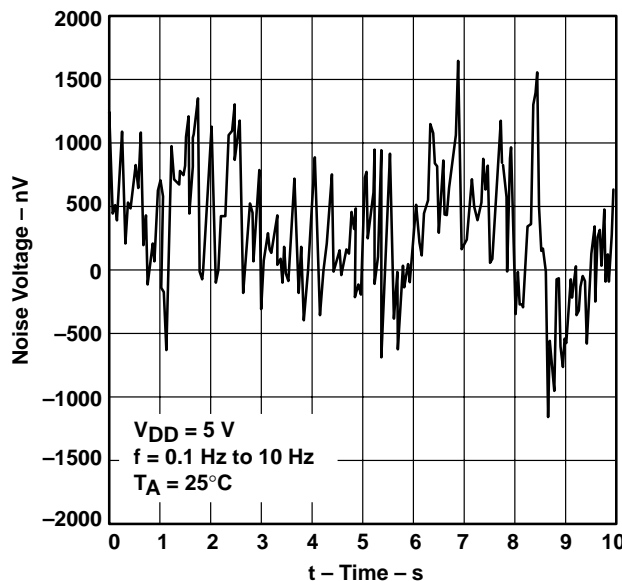

Figure 43

TOTAL HARMONIC DISTORTION PLUS NOISE  
 VS  
 FREQUENCY

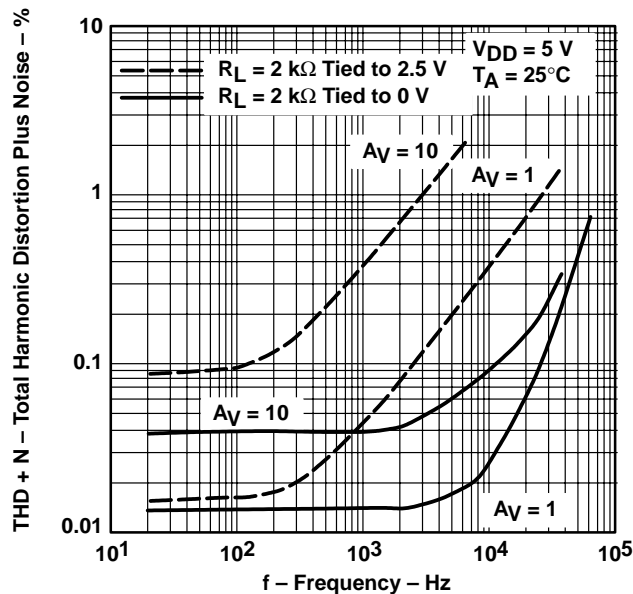

Figure 44

TOTAL HARMONIC DISTORTION PLUS NOISE  
 VS  
 FREQUENCY

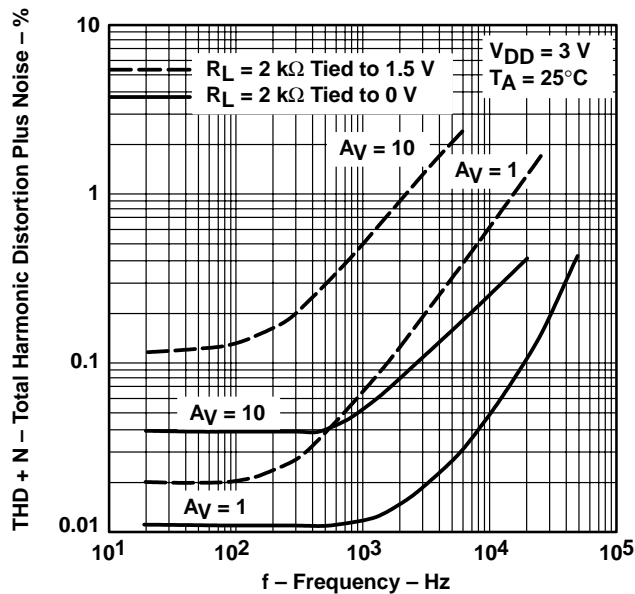

Figure 45

**TLV2432, TLV2432A, TLV2434, TLV2434A**  
**Advanced LinCMOS™ RAIL-TO-RAIL OUTPUT**  
**WIDE-INPUT-VOLTAGE OPERATIONAL AMPLIFIERS**

SLOS168F – NOVEMBER 1996 – REVISED MARCH 2001

**TYPICAL CHARACTERISTICS**

**GAIN-BANDWIDTH PRODUCT**  
**vs**  
**FREE-AIR TEMPERATURE**

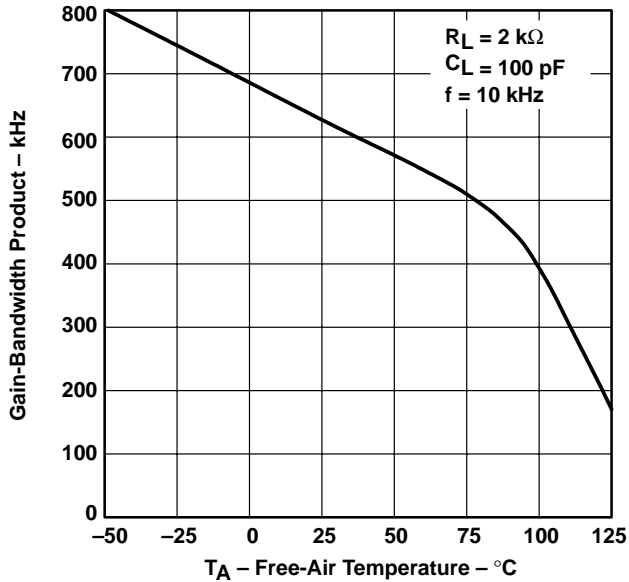

**Figure 46**

**GAIN-BANDWIDTH PRODUCT**  
**vs**  
**SUPPLY VOLTAGE**

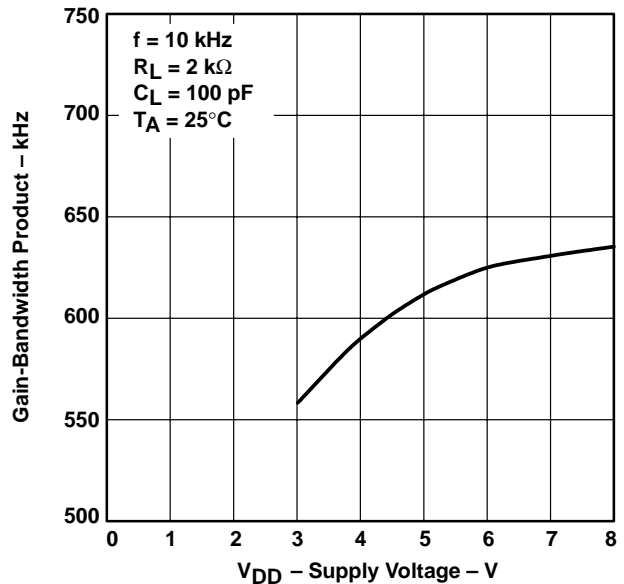

**Figure 47**

**PHASE MARGIN**  
**vs**  
**LOAD CAPACITANCE**

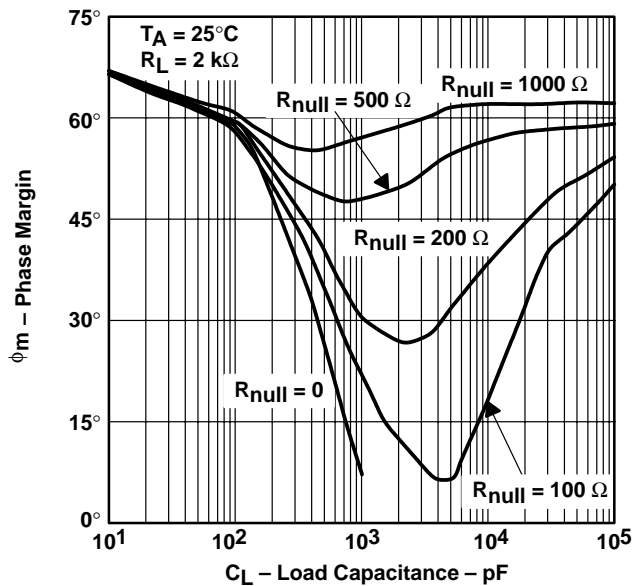

**Figure 48**

**GAIN MARGIN**  
**vs**  
**LOAD CAPACITANCE**

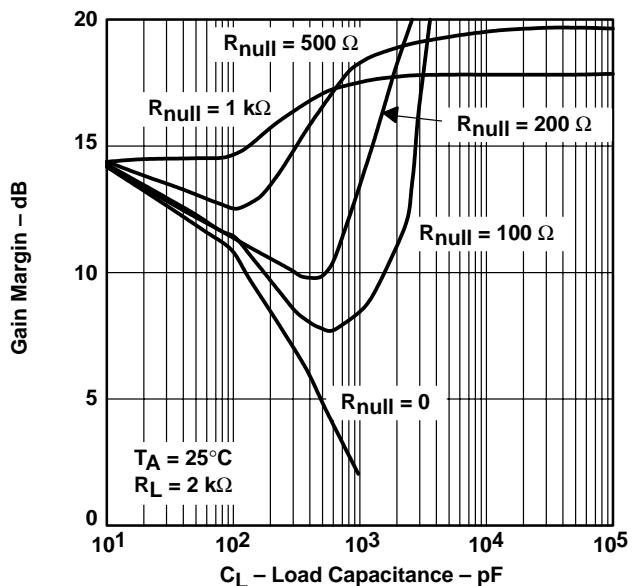

**Figure 49**



TYPICAL CHARACTERISTICS

UNITY-GAIN BANDWIDTH  
vs  
LOAD CAPACITANCE

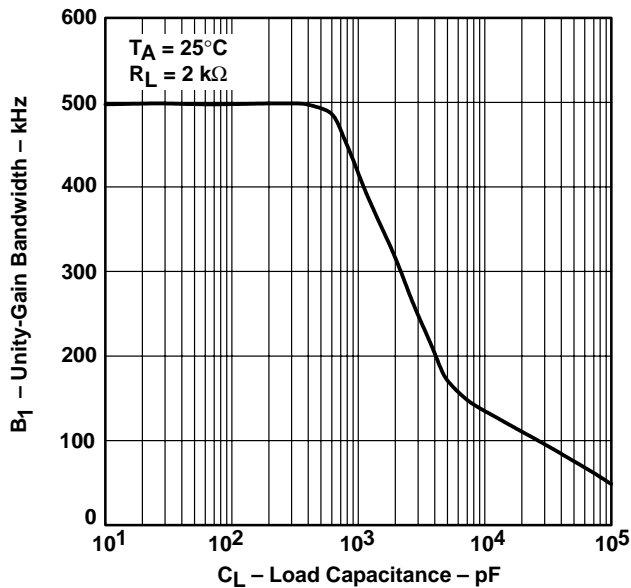

Figure 50

# TLV2432, TLV2432A, TLV2434, TLV2434A Advanced LinCMOS™ RAIL-TO-RAIL OUTPUT WIDE-INPUT-VOLTAGE OPERATIONAL AMPLIFIERS

SLOS168F – NOVEMBER 1996 – REVISED MARCH 2001

## APPLICATION INFORMATION

### macromodel information

Macromodel information provided was derived using Microsim *Parts*™, the model generation software used with Microsim *PSpice*™. The Boyle macromodel (see Note 5) and subcircuit in Figure 51 are generated using the TLV243x typical electrical and operating characteristics at  $T_A = 25^\circ\text{C}$ . Using this information, output simulations of the following key parameters can be generated to a tolerance of 20% (in most cases):

- Maximum positive output voltage swing
- Maximum negative output voltage swing
- Slew rate
- Quiescent power dissipation
- Input bias current
- Open-loop voltage amplification
- Unity-gain frequency
- Common-mode rejection ratio
- Phase margin
- DC output resistance
- AC output resistance
- Short-circuit output current limit

NOTE 4: G. R. Boyle, B. M. Cohn, D. O. Pederson, and J. E. Solomon, "Macromodeling of Integrated Circuit Operational Amplifiers", *IEEE Journal of Solid-State Circuits*, SC-9, 353 (1974).

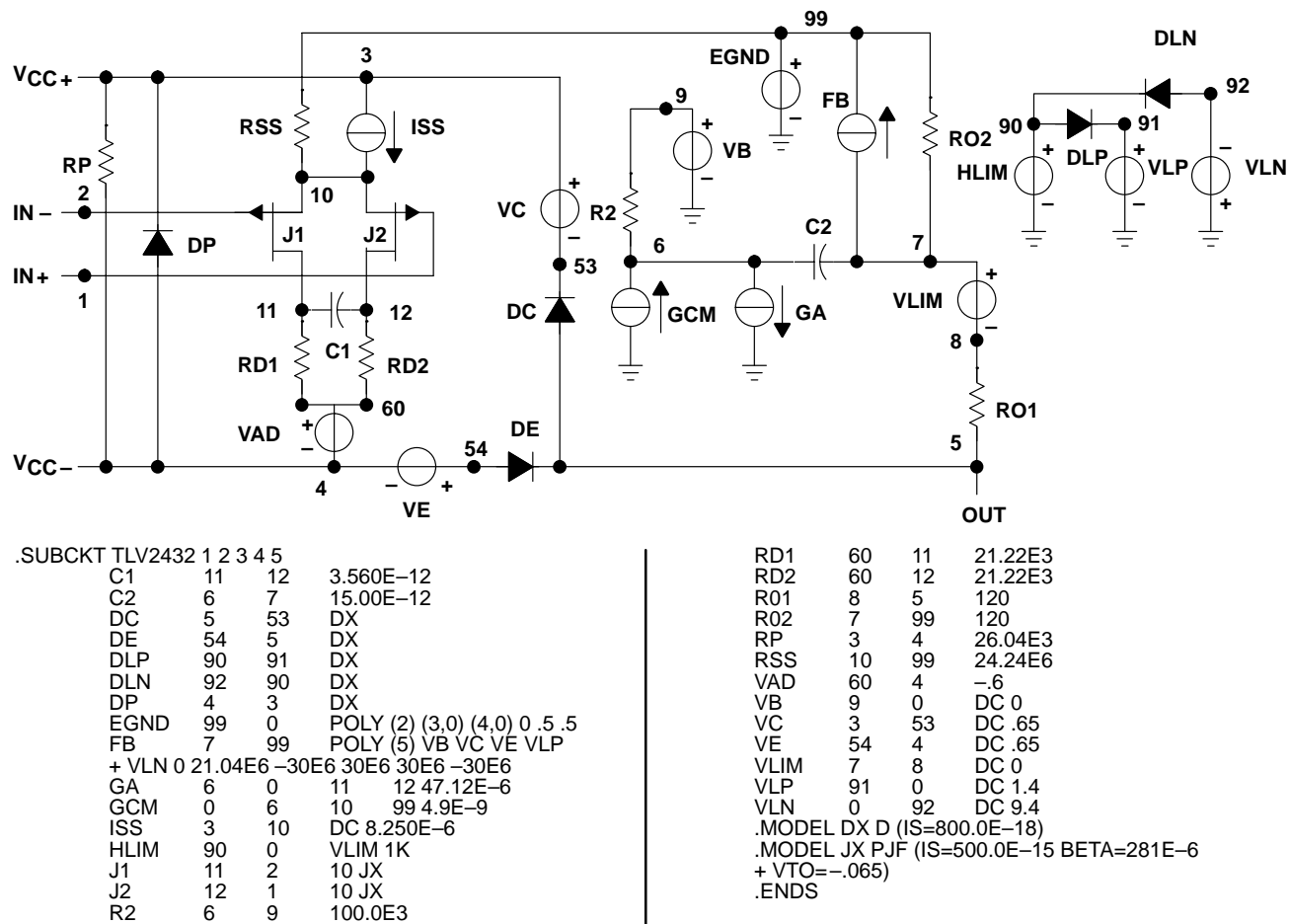

Figure 51. Boyle Macromodel and Subcircuit

PSpice and Parts are trademarks of MicroSim Corporation.



POST OFFICE BOX 655303 • DALLAS, TEXAS 75265

TLV2432, TLV2432A, TLV2434, TLV2434A  
 Advanced LinCMOS™ RAIL-TO-RAIL OUTPUT  
 WIDE-INPUT-VOLTAGE OPERATIONAL AMPLIFIERS

SLOS168F – NOVEMBER 1996 – REVISED MARCH 2001

MECHANICAL DATA

D (R-PDSO-G\*\*)

PLASTIC SMALL-OUTLINE PACKAGE

14 PIN SHOWN

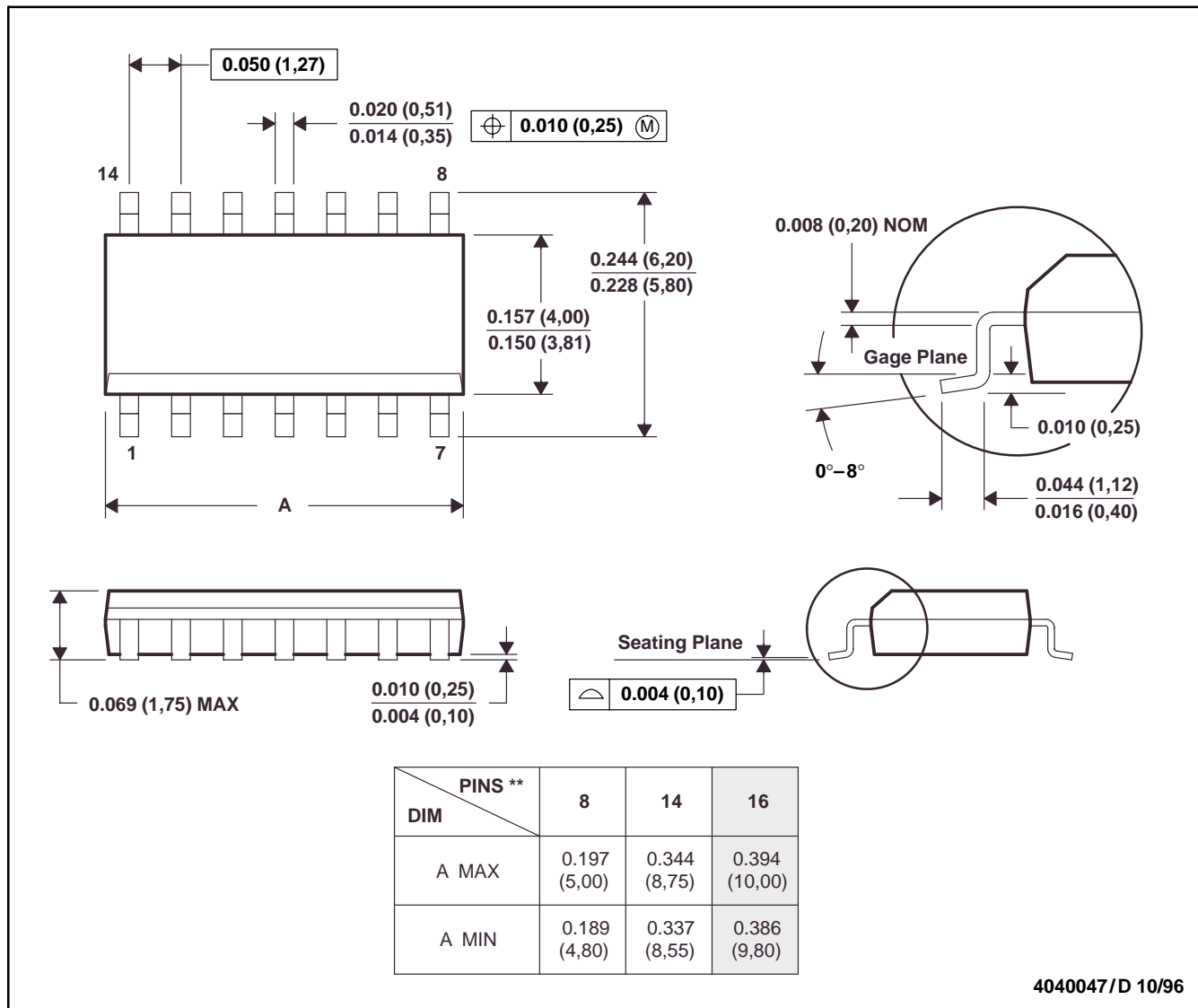

- NOTES: A. All linear dimensions are in inches (millimeters).  
 B. This drawing is subject to change without notice.  
 C. Body dimensions do not include mold flash or protrusion, not to exceed 0.006 (0,15).  
 D. Falls within JEDEC MS-012

**TLV2432, TLV2432A, TLV2434, TLV2434A**  
**Advanced LinCMOS™ RAIL-TO-RAIL OUTPUT**  
**WIDE-INPUT-VOLTAGE OPERATIONAL AMPLIFIERS**

SLOS168F – NOVEMBER 1996 – REVISED MARCH 2001

**MECHANICAL DATA**

**FK (S-CQCC-N\*\*)**

**LEADLESS CERAMIC CHIP CARRIER**

28 TERMINAL SHOWN

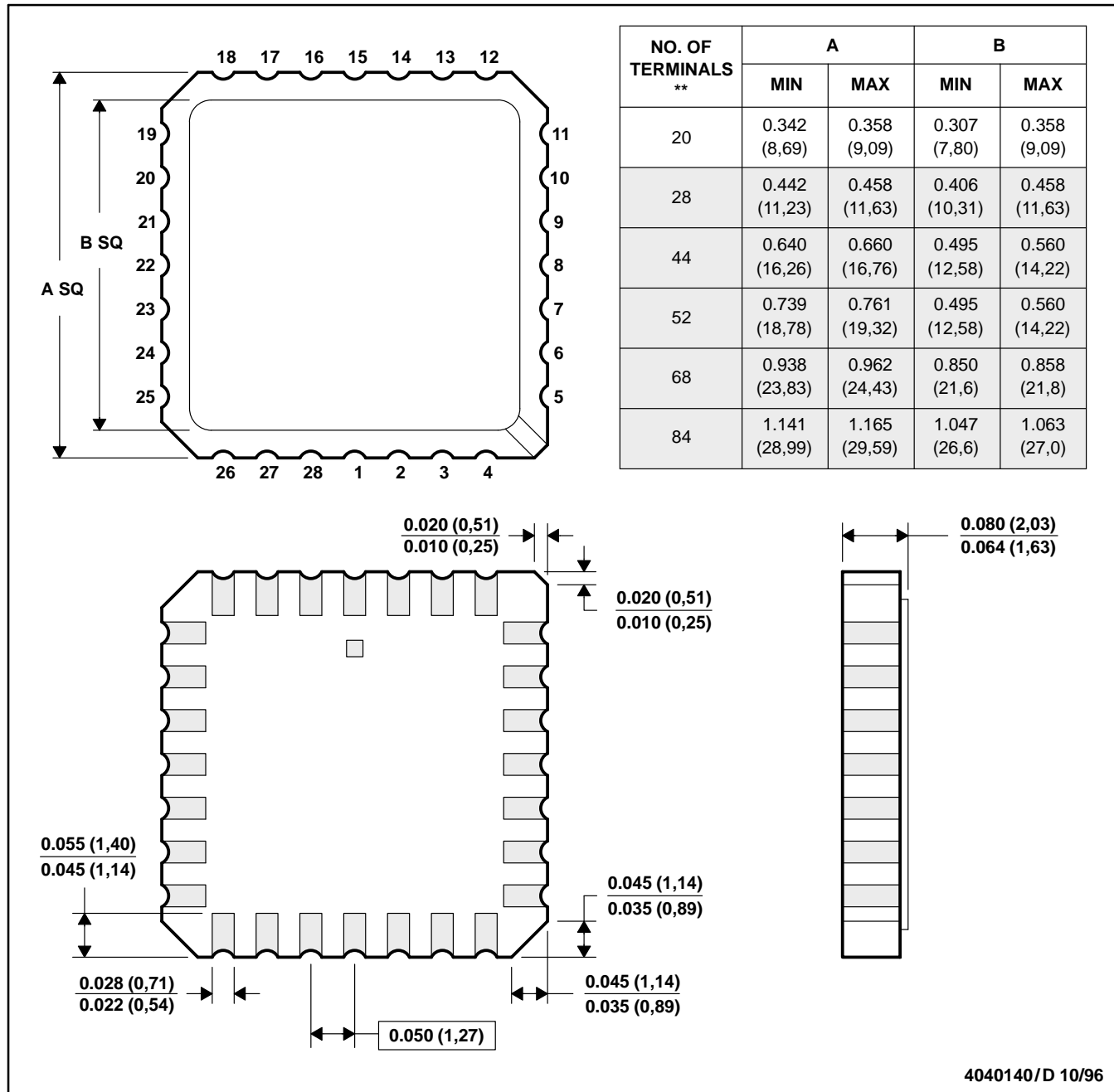

4040140/D 10/96

- NOTES: A. All linear dimensions are in inches (millimeters).  
 B. This drawing is subject to change without notice.  
 C. This package can be hermetically sealed with a metal lid.  
 D. The terminals are gold plated.  
 E. Falls within JEDEC MS-004



TLV2432, TLV2432A, TLV2434, TLV2434A  
 Advanced LinCMOS™ RAIL-TO-RAIL OUTPUT  
 WIDE-INPUT-VOLTAGE OPERATIONAL AMPLIFIERS

SLOS168F – NOVEMBER 1996 – REVISED MARCH 2001

MECHANICAL DATA

JG (R-GDIP-T8)

CERAMIC DUAL-IN-LINE PACKAGE

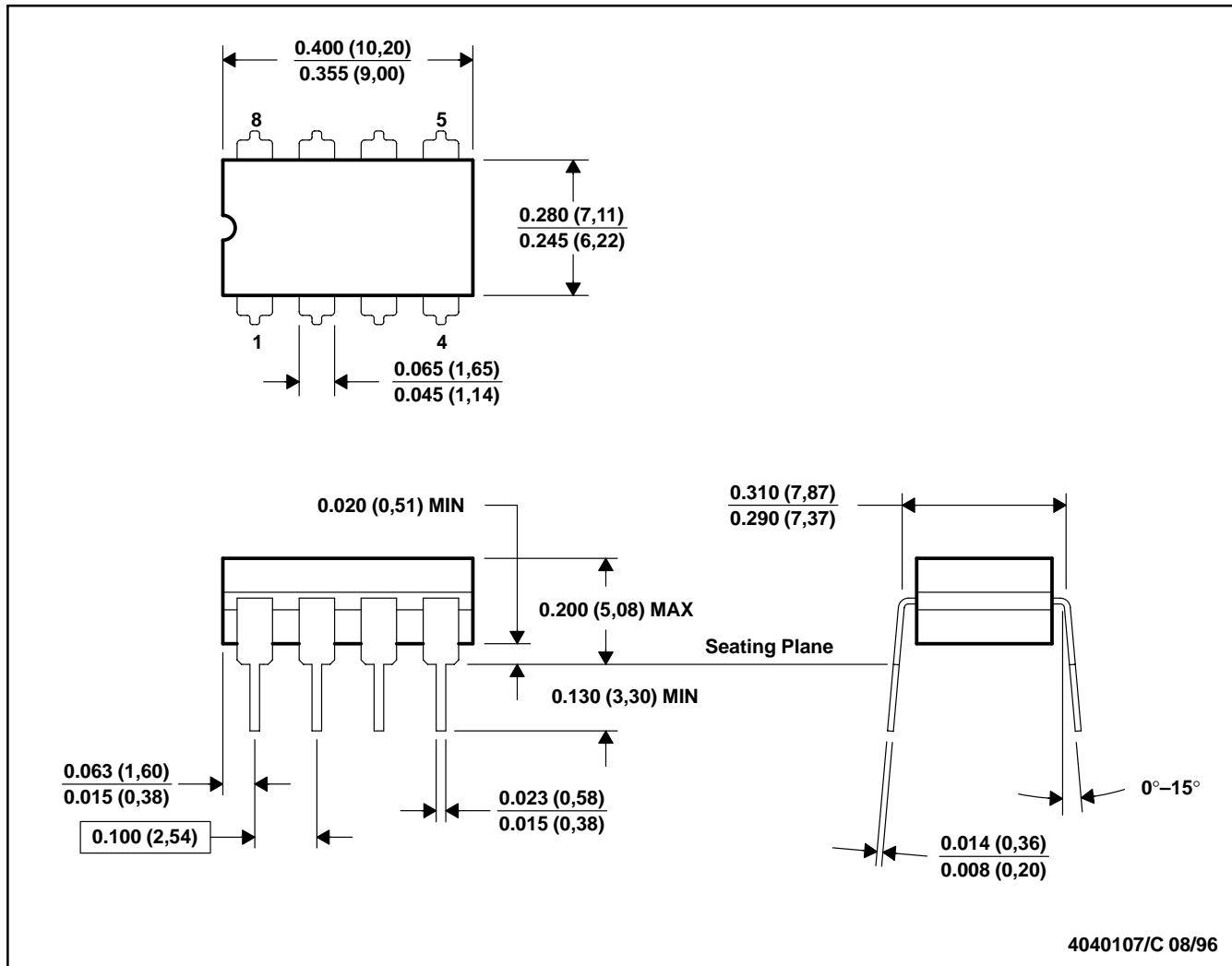

- NOTES: A. All linear dimensions are in inches (millimeters).  
 B. This drawing is subject to change without notice.  
 C. This package can be hermetically sealed with a ceramic lid using glass frit.  
 D. Index point is provided on cap for terminal identification on press ceramic glass frit seal only.  
 E. Falls within MIL-STD-1835 GDIP1-T8

**TLV2432, TLV2432A, TLV2434, TLV2434A**  
**Advanced LinCMOS™ RAIL-TO-RAIL OUTPUT**  
**WIDE-INPUT-VOLTAGE OPERATIONAL AMPLIFIERS**

SLOS168F – NOVEMBER 1996 – REVISED MARCH 2001

**MECHANICAL DATA**

**PW (R-PDSO-G\*\*)**

**PLASTIC SMALL-OUTLINE PACKAGE**

14 PIN SHOWN

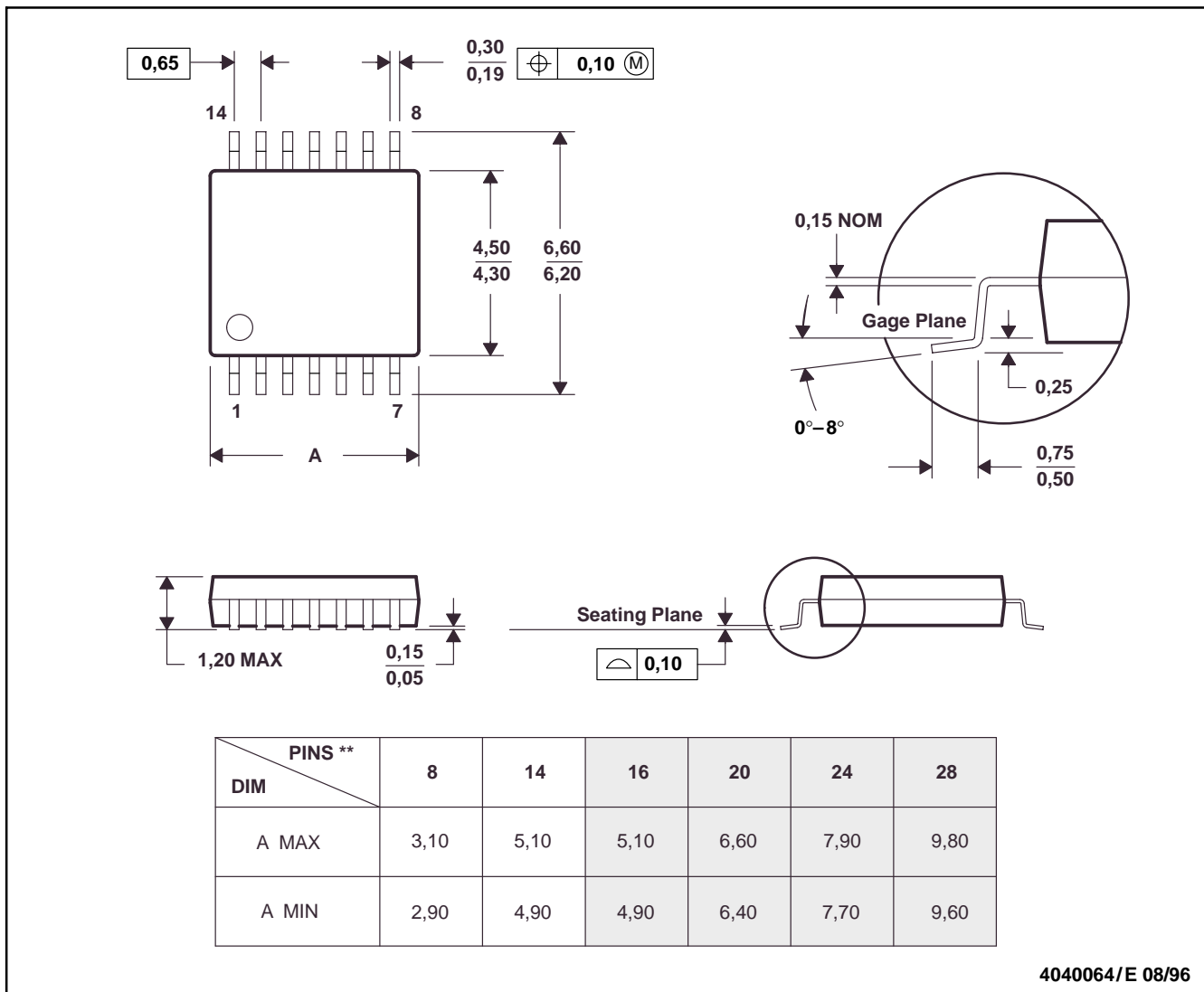

4040064/E 08/96

- NOTES: A. All linear dimensions are in millimeters.  
 B. This drawing is subject to change without notice.  
 C. Body dimensions do not include mold flash or protrusion not to exceed 0,15.  
 D. Falls within JEDEC MO-153

TLV2432, TLV2432A, TLV2434, TLV2434A  
 Advanced LinCMOS™ RAIL-TO-RAIL OUTPUT  
 WIDE-INPUT-VOLTAGE OPERATIONAL AMPLIFIERS

SLOS168F – NOVEMBER 1996 – REVISED MARCH 2001

MECHANICAL DATA

U (S-GDFP-F10)

CERAMIC DUAL FLATPACK

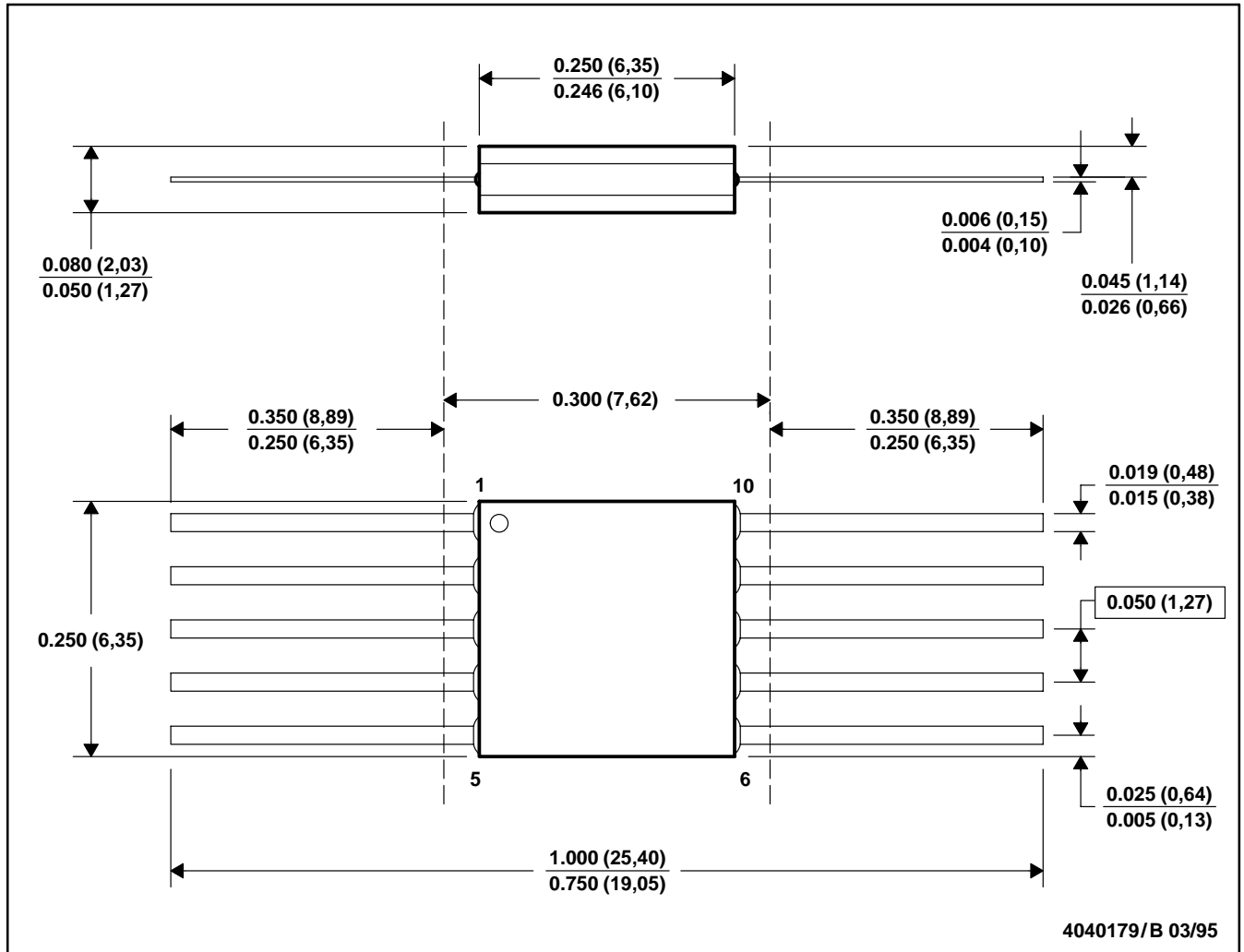

- NOTES: A. All linear dimensions are in inches (millimeters).  
 B. This drawing is subject to change without notice.  
 C. This package can be hermetically sealed with a ceramic lid using glass frit.  
 D. Index point is provided on cap for terminal identification only.  
 E. Falls within MIL STD 1835 GDFP1-F10 and JEDEC MO-092AA

**PACKAGING INFORMATION**

Orderable Device	Status <sup>(1)</sup>	Package Type	Package Drawing	Pins	Package Qty	Eco Plan <sup>(2)</sup>	Lead/Ball Finish	MSL Peak Temp <sup>(3)</sup>
5962-9751001Q2A	ACTIVE	LCCC	FK	20	1	None	POST-PLATE	Level-NC-NC-NC
5962-9751001QHA	ACTIVE	CFP	U	10	1	None	A42 SNPB	Level-NC-NC-NC
5962-9751001QPA	ACTIVE	CDIP	JG	8	1	None	A42 SNPB	Level-NC-NC-NC
5962-9751002Q2A	ACTIVE	LCCC	FK	20	1	None	POST-PLATE	Level-NC-NC-NC
5962-9751002QHA	ACTIVE	CFP	U	10	1	None	A42 SNPB	Level-NC-NC-NC
5962-9751002QPA	ACTIVE	CDIP	JG	8	1	None	A42 SNPB	Level-NC-NC-NC
TLV2432AID	ACTIVE	SOIC	D	8	75	Pb-Free (RoHS)	CU NIPDAU	Level-2-260C-1YEAR/ Level-1-220C-UNLIM
TLV2432AIDR	ACTIVE	SOIC	D	8	2500	Pb-Free (RoHS)	CU NIPDAU	Level-2-260C-1YEAR/ Level-1-220C-UNLIM
TLV2432AIPW	ACTIVE	TSSOP	PW	8	150	None	CU NIPDAU	Level-1-220C-UNLIM
TLV2432AIPWLE	OBSOLETE	TSSOP	PW	8		None	Call TI	Call TI
TLV2432AIPWR	ACTIVE	TSSOP	PW	8	2000	None	CU NIPDAU	Level-1-220C-UNLIM
TLV2432AMFKB	ACTIVE	LCCC	FK	20	1	None	POST-PLATE	Level-NC-NC-NC
TLV2432AMJGB	ACTIVE	CDIP	JG	8	1	None	A42 SNPB	Level-NC-NC-NC
TLV2432AMUB	ACTIVE	CFP	U	10	1	None	A42 SNPB	Level-NC-NC-NC
TLV2432AQD	ACTIVE	SOIC	D	8	75	None	CU NIPDAU	Level-1-220C-UNLIM
TLV2432AQDR	ACTIVE	SOIC	D	8	2500	None	CU NIPDAU	Level-1-220C-UNLIM
TLV2432CD	ACTIVE	SOIC	D	8	75	Pb-Free (RoHS)	CU NIPDAU	Level-2-260C-1YEAR/ Level-1-220C-UNLIM
TLV2432CDR	ACTIVE	SOIC	D	8	2500	Pb-Free (RoHS)	CU NIPDAU	Level-2-260C-1YEAR/ Level-1-220C-UNLIM
TLV2432CPW	ACTIVE	TSSOP	PW	8	150	None	CU NIPDAU	Level-1-220C-UNLIM
TLV2432CPWR	ACTIVE	TSSOP	PW	8	2000	None	CU NIPDAU	Level-1-220C-UNLIM
TLV2432ID	ACTIVE	SOIC	D	8	75	Pb-Free (RoHS)	CU NIPDAU	Level-2-260C-1YEAR/ Level-1-220C-UNLIM
TLV2432IDR	ACTIVE	SOIC	D	8	2500	Pb-Free (RoHS)	CU NIPDAU	Level-2-260C-1YEAR/ Level-1-220C-UNLIM
TLV2432IPW	ACTIVE	TSSOP	PW	8	150	None	Call TI	Call TI
TLV2432IPWR	ACTIVE	TSSOP	PW	8	2000	None	Call TI	Call TI
TLV2432MFKB	ACTIVE	LCCC	FK	20	1	None	POST-PLATE	Level-NC-NC-NC
TLV2432MJGB	ACTIVE	CDIP	JG	8	1	None	A42 SNPB	Level-NC-NC-NC
TLV2432MUB	ACTIVE	CFP	U	10	1	None	A42 SNPB	Level-NC-NC-NC
TLV2432QD	ACTIVE	SOIC	D	8	75	None	CU NIPDAU	Level-1-220C-UNLIM
TLV2432QDR	ACTIVE	SOIC	D	8	2500	None	CU NIPDAU	Level-1-220C-UNLIM
TLV2434AID	ACTIVE	SOIC	D	14	50	Pb-Free (RoHS)	CU NIPDAU	Level-2-260C-1YEAR/ Level-1-220C-UNLIM
TLV2434AIDR	ACTIVE	SOIC	D	14	2500	Pb-Free (RoHS)	CU NIPDAU	Level-2-260C-1YEAR/ Level-1-220C-UNLIM
TLV2434AIPW	ACTIVE	TSSOP	PW	14	90	None	CU NIPDAU	Level-1-220C-UNLIM
TLV2434AIPWR	ACTIVE	TSSOP	PW	14	2000	None	CU NIPDAU	Level-1-220C-UNLIM
TLV2434CD	ACTIVE	SOIC	D	14	50	Pb-Free (RoHS)	CU NIPDAU	Level-2-260C-1YEAR/ Level-1-220C-UNLIM
TLV2434CDR	ACTIVE	SOIC	D	14	2500	Pb-Free (RoHS)	CU NIPDAU	Level-2-260C-1YEAR/ Level-1-220C-UNLIM

Orderable Device	Status <sup>(1)</sup>	Package Type	Package Drawing	Pins	Package Qty	Eco Plan <sup>(2)</sup>	Lead/Ball Finish	MSL Peak Temp <sup>(3)</sup>
TLV2434CPW	ACTIVE	TSSOP	PW	14	90	None	CU NIPDAU	Level-1-220C-UNLIM
TLV2434CPWR	ACTIVE	TSSOP	PW	14	2000	None	CU NIPDAU	Level-1-220C-UNLIM
TLV2434ID	ACTIVE	SOIC	D	14	50	Pb-Free (RoHS)	CU NIPDAU	Level-2-260C-1YEAR/ Level-1-220C-UNLIM
TLV2434IDR	ACTIVE	SOIC	D	14	2500	Pb-Free (RoHS)	CU NIPDAU	Level-2-260C-1YEAR/ Level-1-220C-UNLIM
TLV2434IPW	ACTIVE	TSSOP	PW	14	90	None	CU NIPDAU	Level-1-220C-UNLIM
TLV2434IPWR	ACTIVE	TSSOP	PW	14	2000	None	CU NIPDAU	Level-1-220C-UNLIM

<sup>(1)</sup> The marketing status values are defined as follows:

**ACTIVE:** Product device recommended for new designs.

**LIFEBUY:** TI has announced that the device will be discontinued, and a lifetime-buy period is in effect.

**NRND:** Not recommended for new designs. Device is in production to support existing customers, but TI does not recommend using this part in a new design.

**PREVIEW:** Device has been announced but is not in production. Samples may or may not be available.

**OBSELETE:** TI has discontinued the production of the device.

<sup>(2)</sup> Eco Plan - May not be currently available - please check <http://www.ti.com/productcontent> for the latest availability information and additional product content details.

**None:** Not yet available Lead (Pb-Free).

**Pb-Free (RoHS):** TI's terms "Lead-Free" or "Pb-Free" mean semiconductor products that are compatible with the current RoHS requirements for all 6 substances, including the requirement that lead not exceed 0.1% by weight in homogeneous materials. Where designed to be soldered at high temperatures, TI Pb-Free products are suitable for use in specified lead-free processes.

**Green (RoHS & no Sb/Br):** TI defines "Green" to mean "Pb-Free" and in addition, uses package materials that do not contain halogens, including bromine (Br) or antimony (Sb) above 0.1% of total product weight.

<sup>(3)</sup> MSL, Peak Temp. -- The Moisture Sensitivity Level rating according to the JEDEC industry standard classifications, and peak solder temperature.

**Important Information and Disclaimer:** The information provided on this page represents TI's knowledge and belief as of the date that it is provided. TI bases its knowledge and belief on information provided by third parties, and makes no representation or warranty as to the accuracy of such information. Efforts are underway to better integrate information from third parties. TI has taken and continues to take reasonable steps to provide representative and accurate information but may not have conducted destructive testing or chemical analysis on incoming materials and chemicals. TI and TI suppliers consider certain information to be proprietary, and thus CAS numbers and other limited information may not be available for release.

In no event shall TI's liability arising out of such information exceed the total purchase price of the TI part(s) at issue in this document sold by TI to Customer on an annual basis.

JG (R-GDIP-T8)

CERAMIC DUAL-IN-LINE

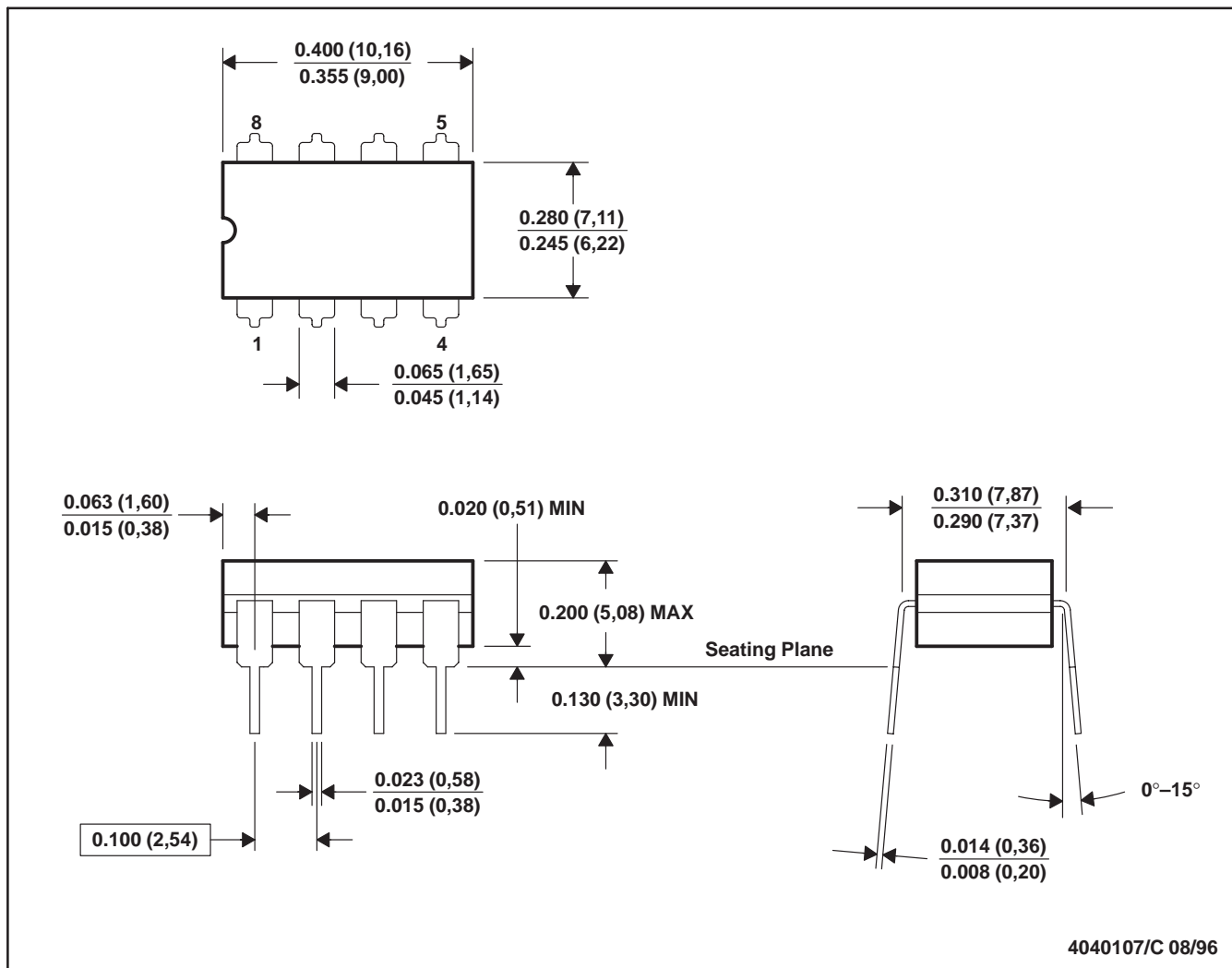

- NOTES: A. All linear dimensions are in inches (millimeters).  
 B. This drawing is subject to change without notice.  
 C. This package can be hermetically sealed with a ceramic lid using glass frit.  
 D. Index point is provided on cap for terminal identification.  
 E. Falls within MIL STD 1835 GDIP1-T8

U (S-GDFP-F10)

CERAMIC DUAL FLATPACK

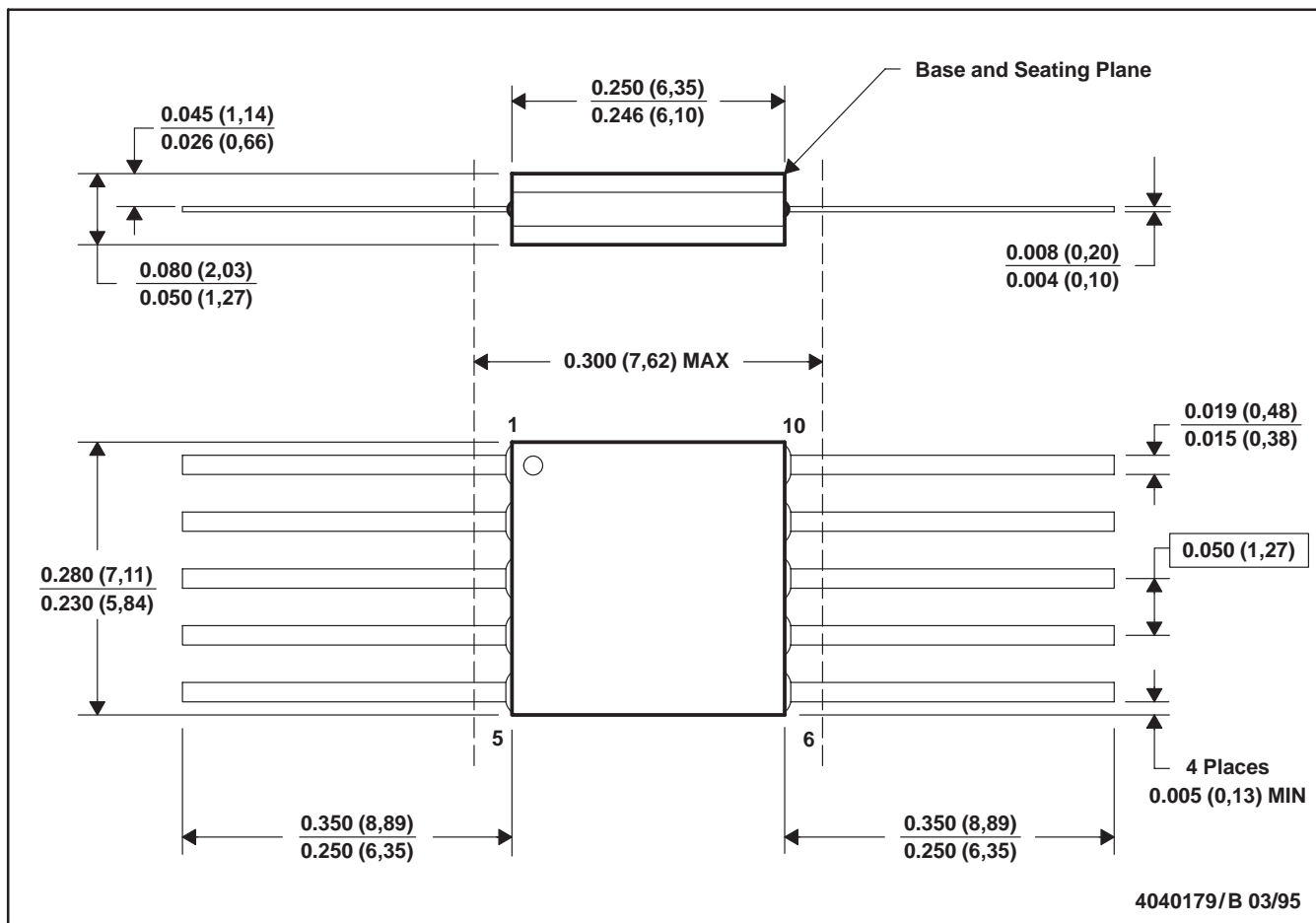

- NOTES:
- A. All linear dimensions are in inches (millimeters).
  - B. This drawing is subject to change without notice.
  - C. This package can be hermetically sealed with a ceramic lid using glass frit.
  - D. Index point is provided on cap for terminal identification only.
  - E. Falls within MIL STD 1835 GDFP1-F10 and JEDEC MO-092AA

FK (S-CQCC-N\*\*)

LEADLESS CERAMIC CHIP CARRIER

28 TERMINAL SHOWN

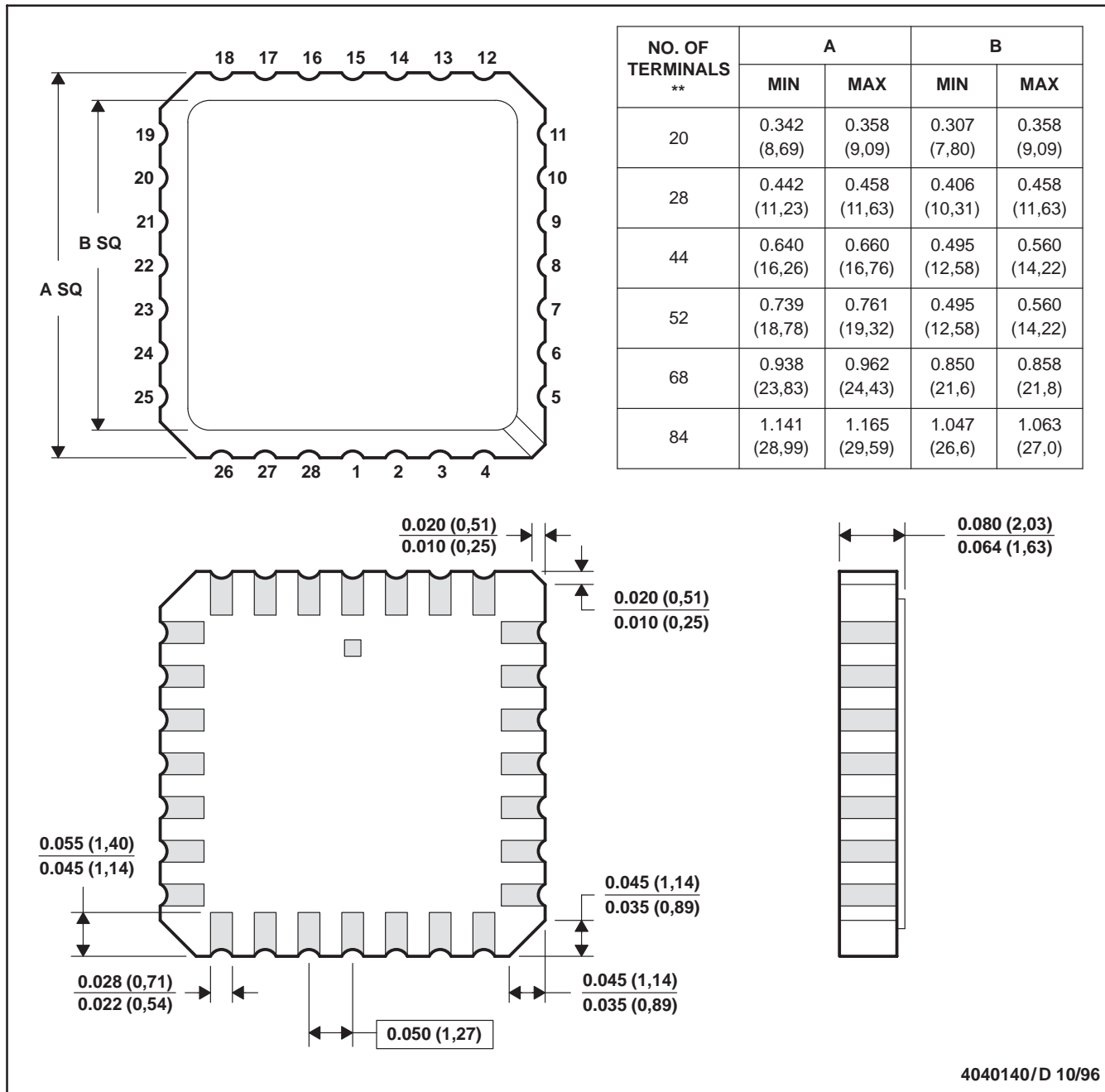

- NOTES:
- A. All linear dimensions are in inches (millimeters).
  - B. This drawing is subject to change without notice.
  - C. This package can be hermetically sealed with a metal lid.
  - D. The terminals are gold plated.
  - E. Falls within JEDEC MS-004

D (R-PDSO-G14)

PLASTIC SMALL-OUTLINE PACKAGE

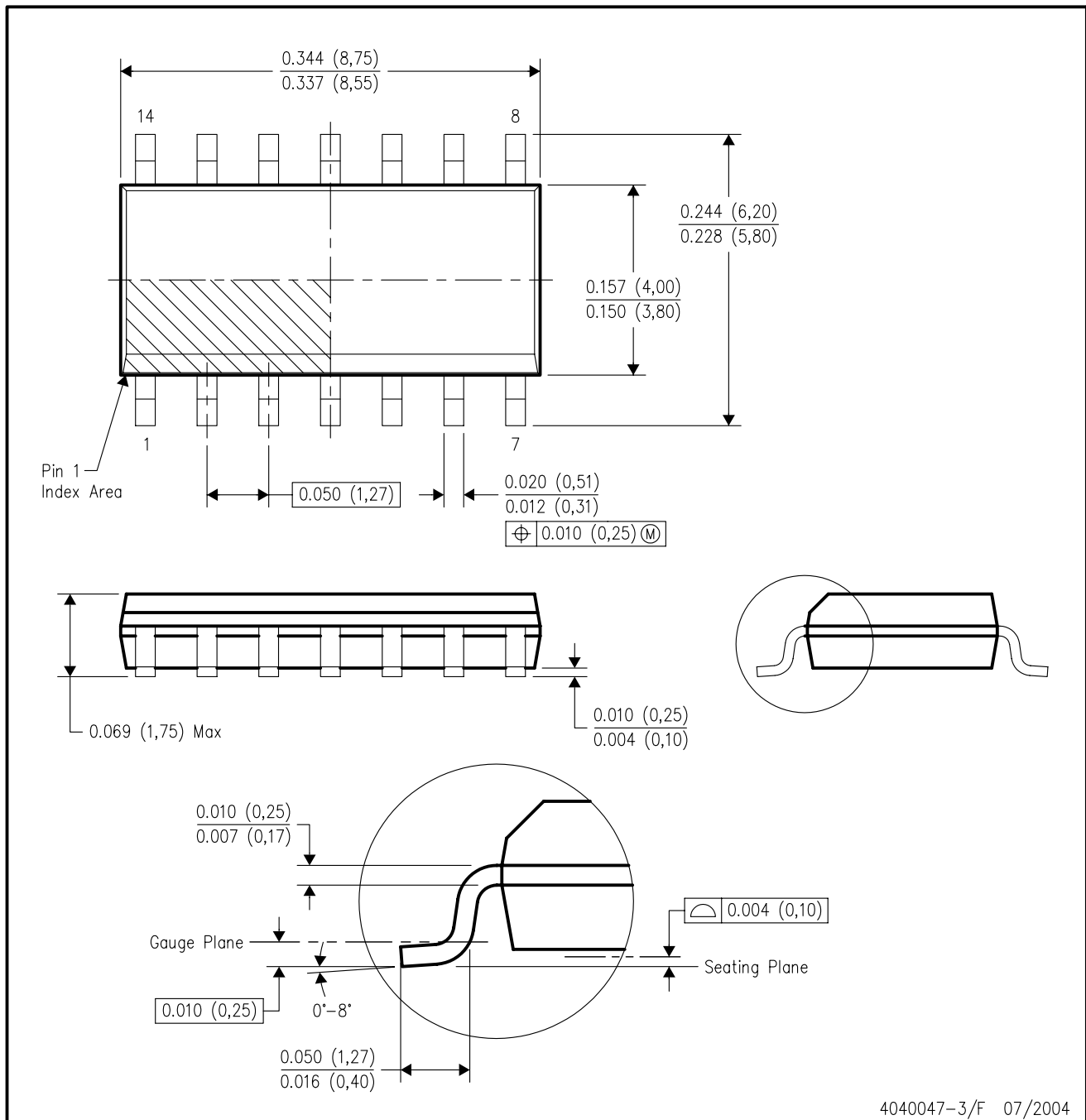

- NOTES:
- A. All linear dimensions are in inches (millimeters).
  - B. This drawing is subject to change without notice.
  - C. Body dimensions do not include mold flash or protrusion not to exceed 0.006 (0,15).
  - D. Falls within JEDEC MS-012 variation AB.

D (R-PDSO-G8)

PLASTIC SMALL-OUTLINE PACKAGE

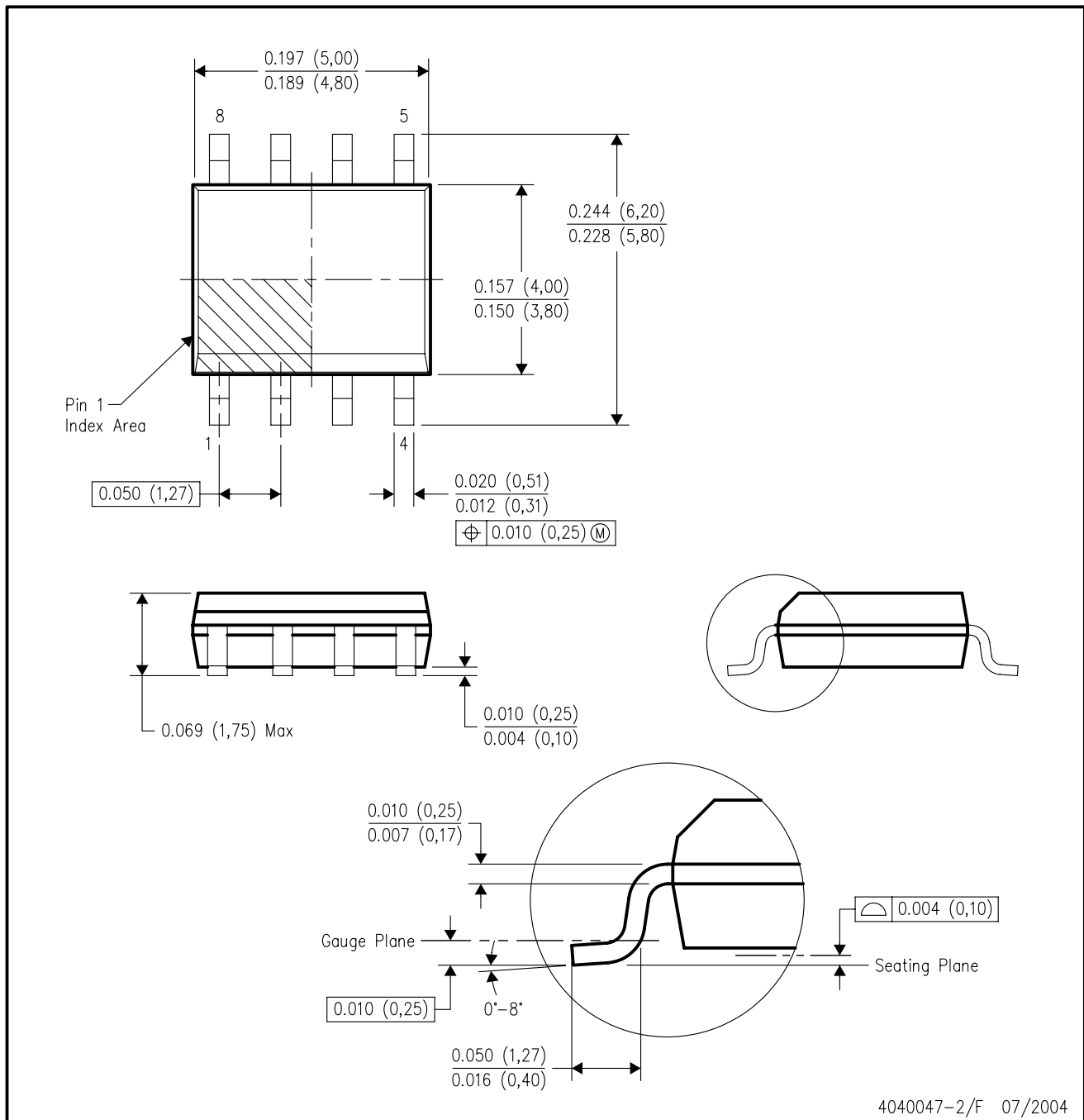

- NOTES:
- A. All linear dimensions are in inches (millimeters).
  - B. This drawing is subject to change without notice.
  - C. Body dimensions do not include mold flash or protrusion not to exceed 0.006 (0,15).
  - D. Falls within JEDEC MS-012 variation AA.

PW (R-PDSO-G\*\*)

PLASTIC SMALL-OUTLINE PACKAGE

14 PINS SHOWN

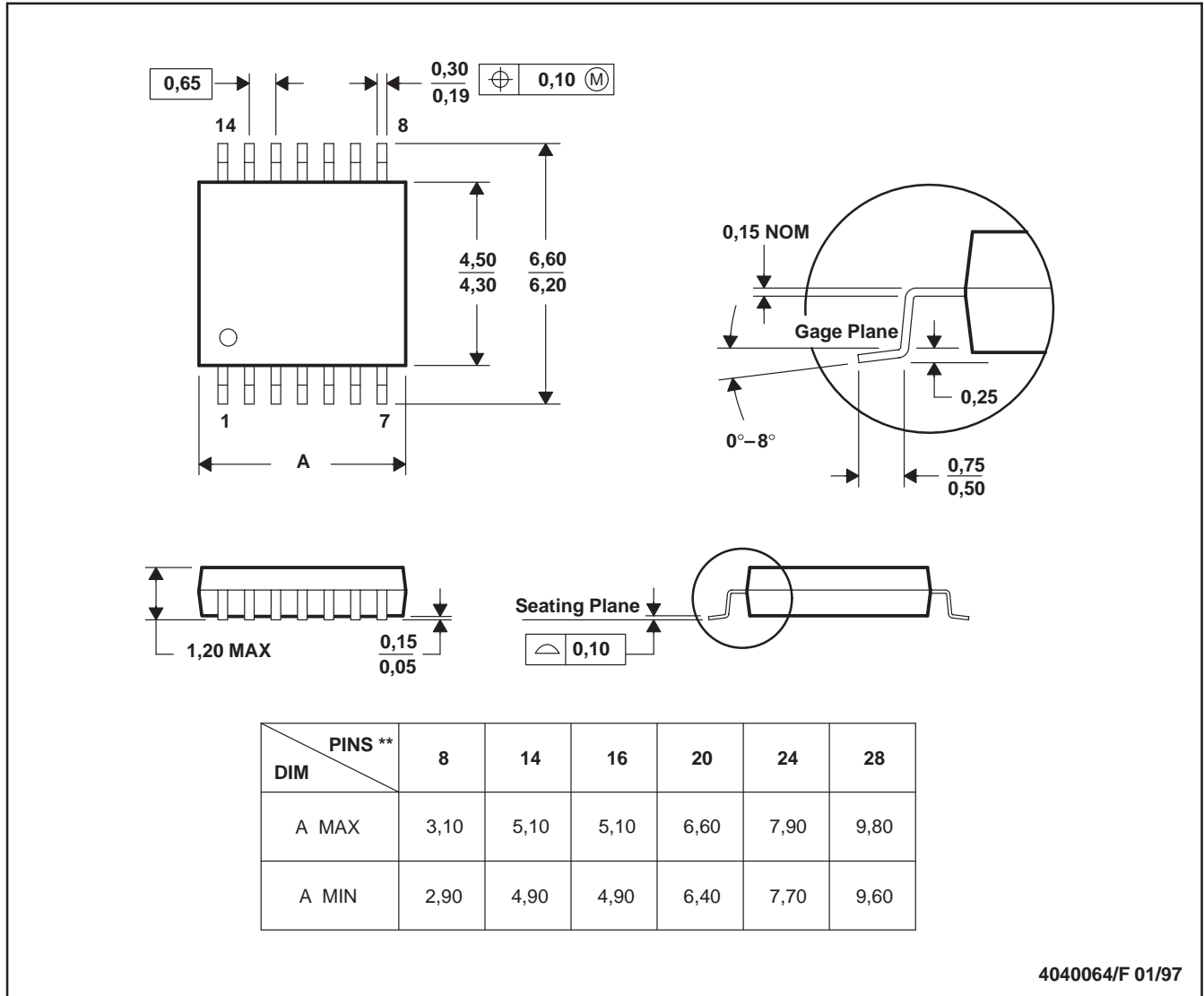

4040064/F 01/97

- NOTES: A. All linear dimensions are in millimeters.  
 B. This drawing is subject to change without notice.  
 C. Body dimensions do not include mold flash or protrusion not to exceed 0,15.  
 D. Falls within JEDEC MO-153

## IMPORTANT NOTICE

Texas Instruments Incorporated and its subsidiaries (TI) reserve the right to make corrections, modifications, enhancements, improvements, and other changes to its products and services at any time and to discontinue any product or service without notice. Customers should obtain the latest relevant information before placing orders and should verify that such information is current and complete. All products are sold subject to TI's terms and conditions of sale supplied at the time of order acknowledgment.

TI warrants performance of its hardware products to the specifications applicable at the time of sale in accordance with TI's standard warranty. Testing and other quality control techniques are used to the extent TI deems necessary to support this warranty. Except where mandated by government requirements, testing of all parameters of each product is not necessarily performed.

TI assumes no liability for applications assistance or customer product design. Customers are responsible for their products and applications using TI components. To minimize the risks associated with customer products and applications, customers should provide adequate design and operating safeguards.

TI does not warrant or represent that any license, either express or implied, is granted under any TI patent right, copyright, mask work right, or other TI intellectual property right relating to any combination, machine, or process in which TI products or services are used. Information published by TI regarding third-party products or services does not constitute a license from TI to use such products or services or a warranty or endorsement thereof. Use of such information may require a license from a third party under the patents or other intellectual property of the third party, or a license from TI under the patents or other intellectual property of TI.

Reproduction of information in TI data books or data sheets is permissible only if reproduction is without alteration and is accompanied by all associated warranties, conditions, limitations, and notices. Reproduction of this information with alteration is an unfair and deceptive business practice. TI is not responsible or liable for such altered documentation.

Resale of TI products or services with statements different from or beyond the parameters stated by TI for that product or service voids all express and any implied warranties for the associated TI product or service and is an unfair and deceptive business practice. TI is not responsible or liable for any such statements.

Following are URLs where you can obtain information on other Texas Instruments products and application solutions:

<b>Products</b>		<b>Applications</b>	
Amplifiers	<a href="http://amplifier.ti.com">amplifier.ti.com</a>	Audio	<a href="http://www.ti.com/audio">www.ti.com/audio</a>
Data Converters	<a href="http://dataconverter.ti.com">dataconverter.ti.com</a>	Automotive	<a href="http://www.ti.com/automotive">www.ti.com/automotive</a>
DSP	<a href="http://dsp.ti.com">dsp.ti.com</a>	Broadband	<a href="http://www.ti.com/broadband">www.ti.com/broadband</a>
Interface	<a href="http://interface.ti.com">interface.ti.com</a>	Digital Control	<a href="http://www.ti.com/digitalcontrol">www.ti.com/digitalcontrol</a>
Logic	<a href="http://logic.ti.com">logic.ti.com</a>	Military	<a href="http://www.ti.com/military">www.ti.com/military</a>
Power Mgmt	<a href="http://power.ti.com">power.ti.com</a>	Optical Networking	<a href="http://www.ti.com/opticalnetwork">www.ti.com/opticalnetwork</a>
Microcontrollers	<a href="http://microcontroller.ti.com">microcontroller.ti.com</a>	Security	<a href="http://www.ti.com/security">www.ti.com/security</a>
		Telephony	<a href="http://www.ti.com/telephony">www.ti.com/telephony</a>
		Video & Imaging	<a href="http://www.ti.com/video">www.ti.com/video</a>
		Wireless	<a href="http://www.ti.com/wireless">www.ti.com/wireless</a>

Mailing Address: Texas Instruments  
Post Office Box 655303 Dallas, Texas 75265