

# SN54AHC02, SN74AHC02 QUADRUPLE 2-INPUT POSITIVE-NOR GATES

SCLS254K– DECEMBER 1995 – REVISED JULY 2003

- Operating Range 2-V to 5.5-V  $V_{CC}$
- Latch-Up Performance Exceeds 250 mA Per JESD 17
- ESD Protection Exceeds JESD 22
  - 2000-V Human-Body Model (A114-A)
  - 200-V Machine Model (A115-A)
  - 1000-V Charged-Device Model (C101)

SN54AHC02 . . . J OR W PACKAGE  
SN74AHC02 . . . D, DB, DGV, N, NS  
OR PW PACKAGE  
(TOP VIEW)

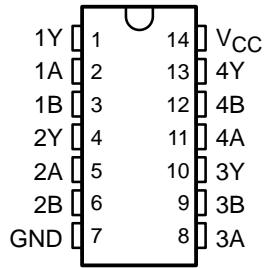

SN74AHC02 . . . RGY PACKAGE  
(TOP VIEW)

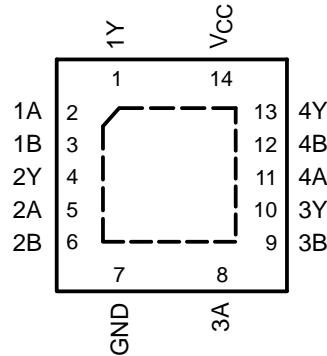

SN54AHC02 . . . FK PACKAGE  
(TOP VIEW)

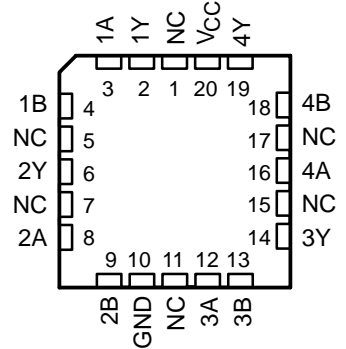

NC – No internal connection

## description/ordering information

The 'AHC02 devices contain four independent 2-input NOR gates that perform the Boolean function  $Y = \overline{A} \cdot \overline{B}$  or  $Y = \overline{A + B}$  in positive logic.

## ORDERING INFORMATION

$T_A$	PACKAGE†		ORDERABLE PART NUMBER	TOP-SIDE MARKING
–40°C to 85°C	QFN – RGY	Tape and reel	SN74AHC02RGYR	HA02
	PDIP – N	Tube	SN74AHC02N	SN74AHC02N
	SOIC – D	Tube	SN74AHC02D	AHC02
		Tape and reel	SN74AHC02DR	
	SOP – NS	Tape and reel	SN74AHC02NSR	AHC02
	SSOP – DB	Tape and reel	SN74AHC02DBR	HA02
	TSSOP – PW	Tube	SN74AHC02PW	HA02
Tape and reel		SN74AHC02PWR		
–55°C to 125°C	TVSOP – DGV	Tape and reel	SN74AHC02DGV	HA02
	CDIP – J	Tube	SNJ54AHC02J	SNJ54AHC02J
	CFP – W	Tube	SNJ54AHC02W	SNJ54AHC02W
	LCCC – FK	Tube	SNJ54AHC02FK	SNJ54AHC02FK

† Package drawings, standard packing quantities, thermal data, symbolization, and PCB design guidelines are available at [www.ti.com/sc/package](http://www.ti.com/sc/package).



Please be aware that an important notice concerning availability, standard warranty, and use in critical applications of Texas Instruments semiconductor products and disclaimers thereto appears at the end of this data sheet.

PRODUCTION DATA information is current as of publication date. Products conform to specifications per the terms of Texas Instruments standard warranty. Production processing does not necessarily include testing of all parameters.

 **TEXAS  
INSTRUMENTS**

POST OFFICE BOX 655303 • DALLAS, TEXAS 75265

Copyright © 2003, Texas Instruments Incorporated  
On products compliant to MIL-PRF-38535, all parameters are tested unless otherwise noted. On all other products, production processing does not necessarily include testing of all parameters.

# SN54AHC02, SN74AHC02 QUADRUPLE 2-INPUT POSITIVE-NOR GATES

SCLS254K– DECEMBER 1995 – REVISED JULY 2003

FUNCTION TABLE  
(each gate)

INPUTS		OUTPUT
A	B	Y
H	X	L
X	H	L
L	L	H

## logic diagram (positive logic)

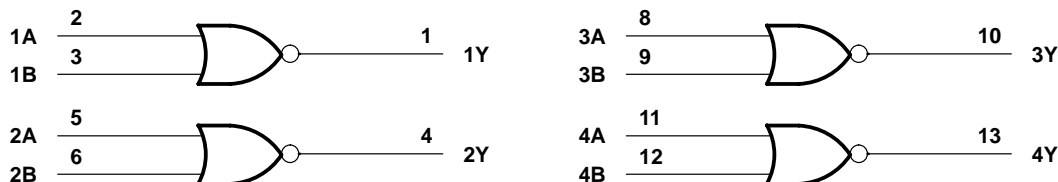

Pin numbers shown are for the D, DB, DGV, J, N, NS, PW, RGY, and W packages.

## absolute maximum ratings over operating free-air temperature range (unless otherwise noted)†

Supply voltage range, $V_{CC}$	–0.5 V to 7 V
Input voltage range, $V_I$ (see Note 1)	–0.5 V to 7 V
Output voltage range, $V_O$ (see Note 1)	–0.5 V to $V_{CC} + 0.5$ V
Input clamp current, $I_{IK}$ ( $V_I < 0$ )	–20 mA
Output clamp current, $I_{OK}$ ( $V_O < 0$ or $V_O > V_{CC}$ )	±20 mA
Continuous output current, $I_O$ ( $V_O = 0$ to $V_{CC}$ )	±25 mA
Continuous current through $V_{CC}$ or GND	±50 mA
Package thermal impedance, $\theta_{JA}$ (see Note 2): D package	86°C/W
(see Note 2): DB package	96°C/W
(see Note 2): DGV package	127°C/W
(see Note 2): N package	80°C/W
(see Note 2): NS package	76°C/W
(see Note 2): PW package	113°C/W
(see Note 3): RGY package	47°C/W
Storage temperature range, $T_{stg}$	–65°C to 150°C

† Stresses beyond those listed under “absolute maximum ratings” may cause permanent damage to the device. These are stress ratings only, and functional operation of the device at these or any other conditions beyond those indicated under “recommended operating conditions” is not implied. Exposure to absolute-maximum-rated conditions for extended periods may affect device reliability.

- NOTES:
1. The input and output voltage ratings may be exceeded if the input and output current ratings are observed.
  2. The package thermal impedance is calculated in accordance with JESD 51-7.
  3. The package thermal impedance is calculated in accordance with JESD 51-5.

# SN54AHC02, SN74AHC02 QUADRUPLE 2-INPUT POSITIVE-NOR GATES

SCLS254K– DECEMBER 1995 – REVISED JULY 2003

## recommended operating conditions (see Note 4)

		SN54AHC02		SN74AHC02		UNIT
		MIN	MAX	MIN	MAX	
V <sub>CC</sub>	Supply voltage	2	5.5	2	5.5	V
V <sub>IH</sub>	High-level input voltage	V <sub>CC</sub> = 2 V		1.5		V
		V <sub>CC</sub> = 3 V		2.1		
		V <sub>CC</sub> = 5.5 V		3.85		
V <sub>IL</sub>	Low-level input voltage	V <sub>CC</sub> = 2 V		0.5		V
		V <sub>CC</sub> = 3 V		0.9		
		V <sub>CC</sub> = 5.5 V		1.65		
V <sub>I</sub>	Input voltage	0	5.5	0	5.5	V
V <sub>O</sub>	Output voltage	0	V <sub>CC</sub>	0	V <sub>CC</sub>	V
I <sub>OH</sub>	High-level output current	V <sub>CC</sub> = 2 V		-50		μA
		V <sub>CC</sub> = 3.3 V ± 0.3 V		-4		
		V <sub>CC</sub> = 5 V ± 0.5 V		-8		
I <sub>OL</sub>	Low-level output current	V <sub>CC</sub> = 2 V		50		μA
		V <sub>CC</sub> = 3.3 V ± 0.3 V		4		
		V <sub>CC</sub> = 5 V ± 0.5 V		8		
Δt/Δv	Input transition rise or fall rate	V <sub>CC</sub> = 3.3 V ± 0.3 V		100		ns/V
		V <sub>CC</sub> = 5 V ± 0.5 V		20		
T <sub>A</sub>	Operating free-air temperature	-55	125	-40	85	°C

NOTE 4: All unused inputs of the device must be held at V<sub>CC</sub> or GND to ensure proper device operation. Refer to the TI application report, *Implications of Slow or Floating CMOS Inputs*, literature number SCBA004.

## electrical characteristics over recommended operating free-air temperature range (unless otherwise noted)

PARAMETER	TEST CONDITIONS	V <sub>CC</sub>	T <sub>A</sub> = 25°C			SN54AHC02		SN74AHC02		UNIT
			MIN	TYP	MAX	MIN	MAX	MIN	MAX	
V <sub>OH</sub>	I <sub>OH</sub> = -50 μA	2 V	1.9	2		1.9		1.9	V	
		3 V	2.9	3		2.9		2.9		
		4.5 V	4.4	4.5		4.4		4.4		
	I <sub>OH</sub> = -4 mA	3 V	2.58			2.48		2.48		
	I <sub>OH</sub> = -8 mA	4.5 V	3.94			3.8		3.8		
V <sub>OL</sub>	I <sub>OL</sub> = 50 μA	2 V				0.1		0.1	V	
		3 V				0.1		0.1		
		4.5 V				0.1		0.1		
	I <sub>OL</sub> = 4 mA	3 V				0.36		0.5		0.44
	I <sub>OL</sub> = 8 mA	4.5 V				0.36		0.5		0.44
I <sub>I</sub>	V <sub>I</sub> = 5.5 V or GND	0 V to 5.5 V				±0.1		±1*	±1	μA
I <sub>CC</sub>	V <sub>I</sub> = V <sub>CC</sub> or GND, I <sub>O</sub> = 0	5.5 V				2		20	20	μA
C <sub>i</sub>	V <sub>I</sub> = V <sub>CC</sub> or GND	5 V							10	pF

\* On products compliant to MIL-PRF-38535, this parameter is not production tested at V<sub>CC</sub> = 0 V.



# SN54AHC02, SN74AHC02 QUADRUPLE 2-INPUT POSITIVE-NOR GATES

SCLS254K- DECEMBER 1995 - REVISED JULY 2003

switching characteristics over recommended operating free-air temperature range,  
 $V_{CC} = 3.3\text{ V} \pm 0.3\text{ V}$  (unless otherwise noted) (see Figure 1)

PARAMETER	FROM (INPUT)	TO (OUTPUT)	LOAD CAPACITANCE	$T_A = 25^\circ\text{C}$			SN54AHC02		SN74AHC02		UNIT
				MIN	TYP	MAX	MIN	MAX	MIN	MAX	
$t_{PLH}$	A or B	Y	$C_L = 15\text{ pF}$	5.6*	7.9*	1*	9.5*	1	9.5	ns	
$t_{PHL}$				5.6*	7.9*	1*	9.5*	1	9.5		
$t_{PLH}$	A or B	Y	$C_L = 50\text{ pF}$	8.1	11.4	1	13	1	13	ns	
$t_{PHL}$				8.1	11.4	1	13	1	13		

\* On products compliant to MIL-PRF-38535, this parameter is not production tested.

switching characteristics over recommended operating free-air temperature range,  
 $V_{CC} = 5\text{ V} \pm 0.5\text{ V}$  (unless otherwise noted) (see Figure 1)

PARAMETER	FROM (INPUT)	TO (OUTPUT)	LOAD CAPACITANCE	$T_A = 25^\circ\text{C}$			SN54AHC02		SN74AHC02		UNIT
				MIN	TYP	MAX	MIN	MAX	MIN	MAX	
$t_{PLH}$	A or B	Y	$C_L = 15\text{ pF}$	3.6*	5.5*	1*	6.5*	1	6.5	ns	
$t_{PHL}$				3.6*	5.5*	1*	6.5*	1	6.5		
$t_{PLH}$	A or B	Y	$C_L = 50\text{ pF}$	5.1	7.5	1	8.5	1	8.5	ns	
$t_{PHL}$				5.1	7.5	1	8.5	1	8.5		

\* On products compliant to MIL-PRF-38535, this parameter is not production tested.

noise characteristics,  $V_{CC} = 5\text{ V}$ ,  $C_L = 50\text{ pF}$ ,  $T_A = 25^\circ\text{C}$  (see Note 5)

PARAMETER		SN74AHC02		UNIT
		MIN	MAX	
$V_{OL(P)}$	Quiet output, maximum dynamic $V_{OL}$	0.8		V
$V_{OL(V)}$	Quiet output, minimum dynamic $V_{OL}$	-0.8		V
$V_{OH(V)}$	Quiet output, minimum dynamic $V_{OH}$	4.9		V
$V_{IH(D)}$	High-level dynamic input voltage	3.5		V
$V_{IL(D)}$	Low-level dynamic input voltage		1.5	V

NOTE 5: Characteristics are for surface-mount packages only.

operating characteristics,  $V_{CC} = 5\text{ V}$ ,  $T_A = 25^\circ\text{C}$

PARAMETER		TEST CONDITIONS	TYP	UNIT
$C_{pd}$	Power dissipation capacitance	No load, $f = 1\text{ MHz}$	15	pF



PARAMETER MEASUREMENT INFORMATION

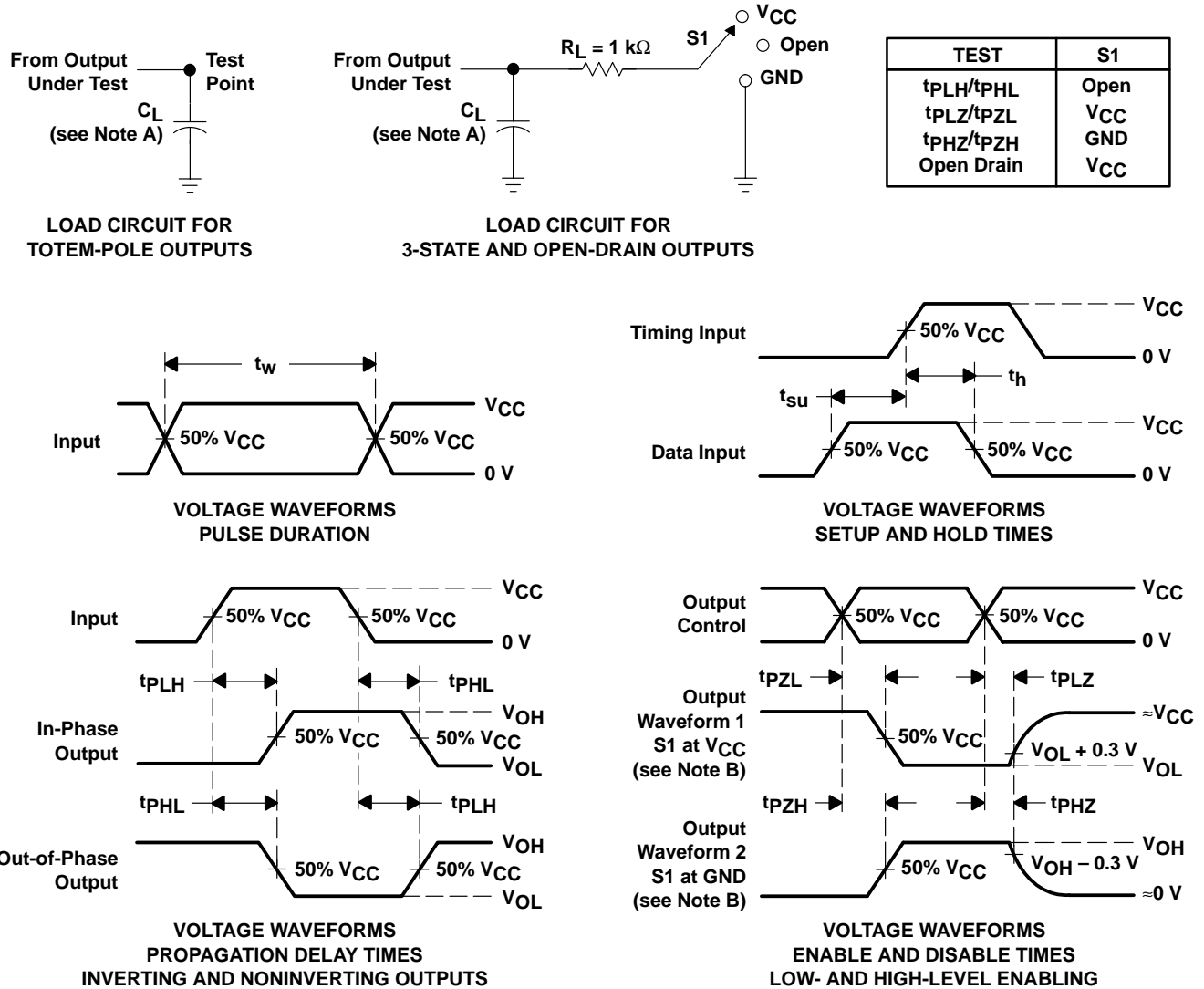

- NOTES: A.  $C_L$  includes probe and jig capacitance.  
 B. Waveform 1 is for an output with internal conditions such that the output is low except when disabled by the output control. Waveform 2 is for an output with internal conditions such that the output is high except when disabled by the output control.  
 C. All input pulses are supplied by generators having the following characteristics:  $PRR \leq 1$  MHz,  $Z_O = 50 \Omega$ ,  $t_r \leq 3$  ns,  $t_f \leq 3$  ns.  
 D. The outputs are measured one at a time with one input transition per measurement.  
 E. All parameters and waveforms are not applicable to all devices.

Figure 1. Load Circuit and Voltage Waveforms

**PACKAGING INFORMATION**

Orderable Device	Status <sup>(1)</sup>	Package Type	Package Drawing	Pins	Package Qty	Eco Plan <sup>(2)</sup>	Lead/Ball Finish	MSL Peak Temp <sup>(3)</sup>
5962-9752801Q2A	ACTIVE	LCCC	FK	20	1	None	Call TI	Level-NC-NC-NC
5962-9752801QCA	ACTIVE	CDIP	J	14	1	None	Call TI	Level-NC-NC-NC
5962-9752801QDA	ACTIVE	CFP	W	14	1	None	Call TI	Level-NC-NC-NC
SN74AHC02D	ACTIVE	SOIC	D	14	50	Pb-Free (RoHS)	CU NIPDAU	Level-2-260C-1 YEAR/ Level-1-235C-UNLIM
SN74AHC02DBLE	OBSOLETE	SSOP	DB	14		None	Call TI	Call TI
SN74AHC02DBR	ACTIVE	SSOP	DB	14	2000	Pb-Free (RoHS)	CU NIPDAU	Level-2-260C-1 YEAR/ Level-1-235C-UNLIM
SN74AHC02DGVR	ACTIVE	TVSOP	DGV	14	2000	Pb-Free (RoHS)	CU NIPDAU	Level-1-250C-UNLIM
SN74AHC02DR	ACTIVE	SOIC	D	14	2500	Pb-Free (RoHS)	CU NIPDAU	Level-2-260C-1 YEAR/ Level-1-235C-UNLIM
SN74AHC02N	ACTIVE	PDIP	N	14	25	Pb-Free (RoHS)	CU NIPDAU	Level-NC-NC-NC
SN74AHC02NSR	ACTIVE	SO	NS	14	2000	Pb-Free (RoHS)	CU NIPDAU	Level-2-260C-1 YEAR/ Level-1-235C-UNLIM
SN74AHC02PW	ACTIVE	TSSOP	PW	14	90	Pb-Free (RoHS)	CU NIPDAU	Level-1-250C-UNLIM
SN74AHC02PWLE	OBSOLETE	TSSOP	PW	14		None	Call TI	Call TI
SN74AHC02PWR	ACTIVE	TSSOP	PW	14	2000	Pb-Free (RoHS)	CU NIPDAU	Level-1-250C-UNLIM
SN74AHC02RGYR	ACTIVE	QFN	RGY	14	1000	Pb-Free (RoHS)	CU NIPDAU	Level-2-260C-1 YEAR
SNJ54AHC02FK	ACTIVE	LCCC	FK	20	1	None	Call TI	Level-NC-NC-NC
SNJ54AHC02J	ACTIVE	CDIP	J	14	1	None	Call TI	Level-NC-NC-NC
SNJ54AHC02W	ACTIVE	CFP	W	14	1	None	Call TI	Level-NC-NC-NC

<sup>(1)</sup> The marketing status values are defined as follows:

**ACTIVE:** Product device recommended for new designs.

**LIFEBUY:** TI has announced that the device will be discontinued, and a lifetime-buy period is in effect.

**NRND:** Not recommended for new designs. Device is in production to support existing customers, but TI does not recommend using this part in a new design.

**PREVIEW:** Device has been announced but is not in production. Samples may or may not be available.

**OBSOLETE:** TI has discontinued the production of the device.

<sup>(2)</sup> Eco Plan - May not be currently available - please check <http://www.ti.com/productcontent> for the latest availability information and additional product content details.

**None:** Not yet available Lead (Pb-Free).

**Pb-Free (RoHS):** TI's terms "Lead-Free" or "Pb-Free" mean semiconductor products that are compatible with the current RoHS requirements for all 6 substances, including the requirement that lead not exceed 0.1% by weight in homogeneous materials. Where designed to be soldered at high temperatures, TI Pb-Free products are suitable for use in specified lead-free processes.

**Green (RoHS & no Sb/Br):** TI defines "Green" to mean "Pb-Free" and in addition, uses package materials that do not contain halogens, including bromine (Br) or antimony (Sb) above 0.1% of total product weight.

<sup>(3)</sup> MSL, Peak Temp. -- The Moisture Sensitivity Level rating according to the JEDEC industry standard classifications, and peak solder temperature.

**Important Information and Disclaimer:** The information provided on this page represents TI's knowledge and belief as of the date that it is provided. TI bases its knowledge and belief on information provided by third parties, and makes no representation or warranty as to the accuracy of such information. Efforts are underway to better integrate information from third parties. TI has taken and continues to take reasonable steps to provide representative and accurate information but may not have conducted destructive testing or chemical analysis on incoming materials and chemicals. TI and TI suppliers consider certain information to be proprietary, and thus CAS numbers and other limited

information may not be available for release.

In no event shall TI's liability arising out of such information exceed the total purchase price of the TI part(s) at issue in this document sold by TI to Customer on an annual basis.

J (R-GDIP-T\*\*)

14 LEADS SHOWN

CERAMIC DUAL IN-LINE PACKAGE



DIM \ PINS **	14	16	18	20
A	0.300 (7,62) BSC	0.300 (7,62) BSC	0.300 (7,62) BSC	0.300 (7,62) BSC
B MAX	0.785 (19,94)	.840 (21,34)	0.960 (24,38)	1.060 (26,92)
B MIN	—	—	—	—
C MAX	0.300 (7,62)	0.300 (7,62)	0.310 (7,87)	0.300 (7,62)
C MIN	0.245 (6,22)	0.245 (6,22)	0.220 (5,59)	0.245 (6,22)



4040083/F 03/03

- NOTES:
- A. All linear dimensions are in inches (millimeters).
  - B. This drawing is subject to change without notice.
  - C. This package is hermetically sealed with a ceramic lid using glass frit.
  - D. Index point is provided on cap for terminal identification only on press ceramic glass frit seal only.
  - E. Falls within MIL STD 1835 GDIP1-T14, GDIP1-T16, GDIP1-T18 and GDIP1-T20.

W (R-GDFP-F14)

CERAMIC DUAL FLATPACK



- NOTES:
- A. All linear dimensions are in inches (millimeters).
  - B. This drawing is subject to change without notice.
  - C. This package can be hermetically sealed with a ceramic lid using glass frit.
  - D. Index point is provided on cap for terminal identification only.
  - E. Falls within MIL STD 1835 GDFP1-F14 and JEDEC MO-092AB

FK (S-CQCC-N\*\*)

LEADLESS CERAMIC CHIP CARRIER

28 TERMINAL SHOWN

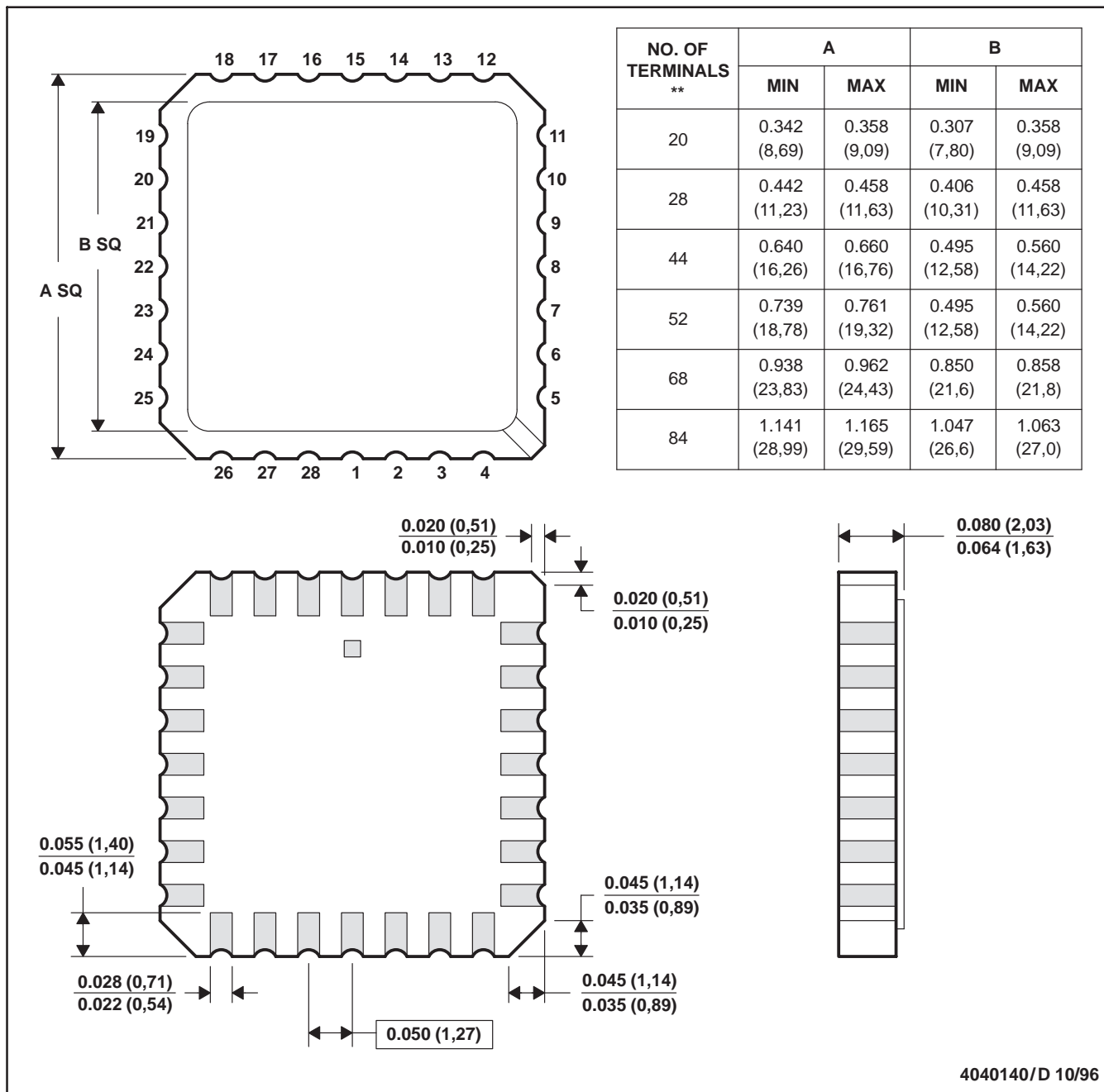

- NOTES:
- A. All linear dimensions are in inches (millimeters).
  - B. This drawing is subject to change without notice.
  - C. This package can be hermetically sealed with a metal lid.
  - D. The terminals are gold plated.
  - E. Falls within JEDEC MS-004

N (R-PDIP-T\*\*)

PLASTIC DUAL-IN-LINE PACKAGE

16 PINS SHOWN



- NOTES:
- A. All linear dimensions are in inches (millimeters).
  - B. This drawing is subject to change without notice.
  - Falls within JEDEC MS-001, except 18 and 20 pin minimum body length (Dim A).
  - The 20 pin end lead shoulder width is a vendor option, either half or full width.

DGV (R-PDSO-G\*\*)

PLASTIC SMALL-OUTLINE

24 PINS SHOWN



- NOTES: A. All linear dimensions are in millimeters.  
 B. This drawing is subject to change without notice.  
 C. Body dimensions do not include mold flash or protrusion, not to exceed 0,15 per side.  
 D. Falls within JEDEC: 24/48 Pins – MO-153  
 14/16/20/56 Pins – MO-194

D (R-PDSO-G14)

PLASTIC SMALL-OUTLINE PACKAGE



- NOTES:
- A. All linear dimensions are in inches (millimeters).
  - B. This drawing is subject to change without notice.
  - C. Body dimensions do not include mold flash or protrusion not to exceed 0.006 (0,15).
  - D. Falls within JEDEC MS-012 variation AB.

RGY (S-PQFP-N14)

PLASTIC QUAD FLATPACK

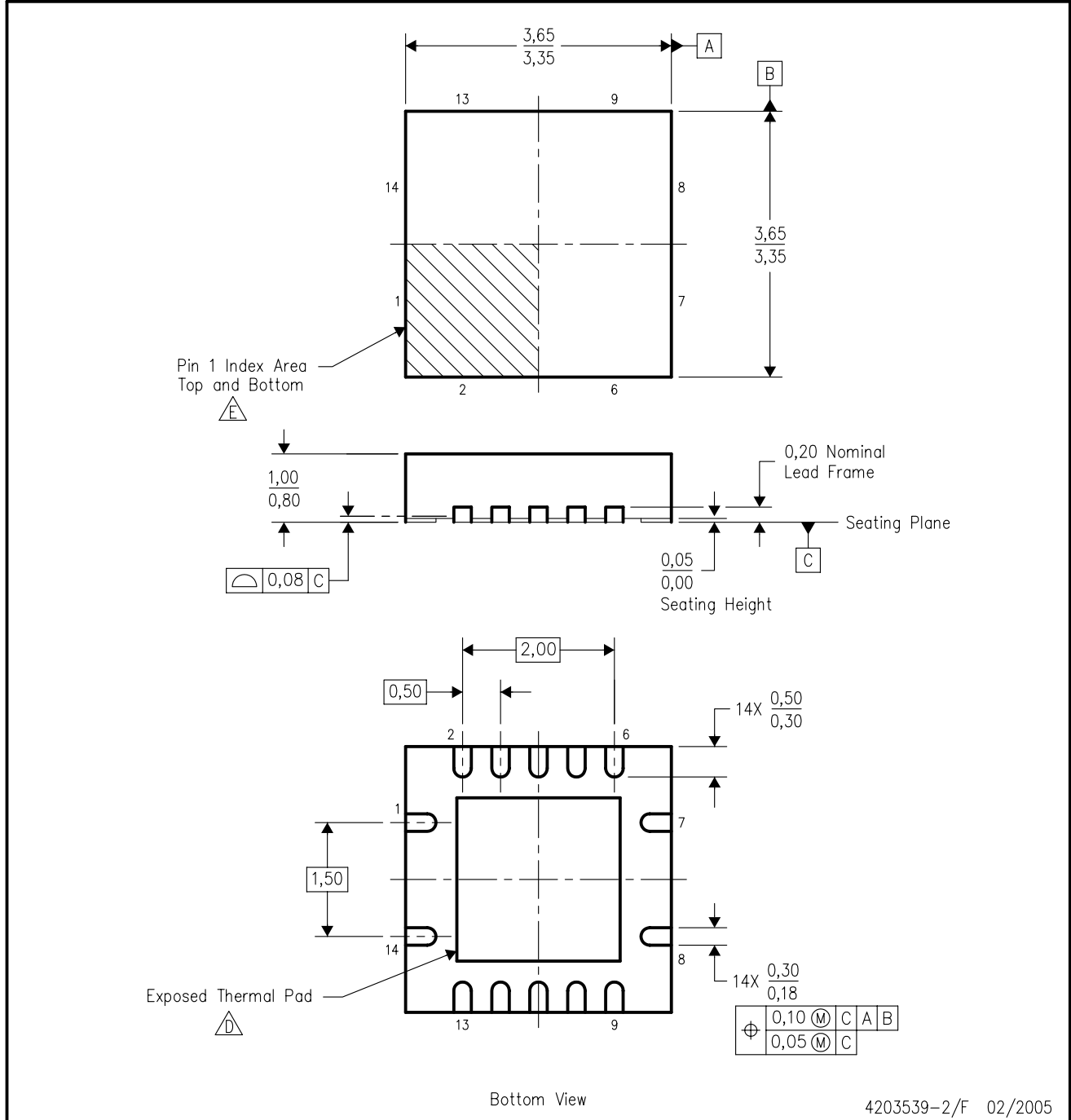

4203539-2/F 02/2005

- NOTES:
- A. All linear dimensions are in millimeters. Dimensioning and tolerancing per ASME Y14.5M-1994.
  - B. This drawing is subject to change without notice.
  - C. QFN (Quad Flatpack No-Lead) package configuration.
  - The package thermal pad must be soldered to the board for thermal and mechanical performance. See the Product Data Sheet for details regarding the exposed thermal pad dimensions.
  - Pin 1 identifiers are located on both top and bottom of the package and within the zone indicated. The Pin 1 identifiers are either a molded, marked, or metal feature.
  - F. Package complies to JEDEC MO-241 variation BA.

# MECHANICAL DATA

NS (R-PDSO-G\*\*)

PLASTIC SMALL-OUTLINE PACKAGE

14-PINS SHOWN



- NOTES:
- A. All linear dimensions are in millimeters.
  - B. This drawing is subject to change without notice.
  - C. Body dimensions do not include mold flash or protrusion, not to exceed 0,15.



PW (R-PDSO-G\*\*)

PLASTIC SMALL-OUTLINE PACKAGE

14 PINS SHOWN



4040064/F 01/97

- NOTES: A. All linear dimensions are in millimeters.  
 B. This drawing is subject to change without notice.  
 C. Body dimensions do not include mold flash or protrusion not to exceed 0,15.  
 D. Falls within JEDEC MO-153

## IMPORTANT NOTICE

Texas Instruments Incorporated and its subsidiaries (TI) reserve the right to make corrections, modifications, enhancements, improvements, and other changes to its products and services at any time and to discontinue any product or service without notice. Customers should obtain the latest relevant information before placing orders and should verify that such information is current and complete. All products are sold subject to TI's terms and conditions of sale supplied at the time of order acknowledgment.

TI warrants performance of its hardware products to the specifications applicable at the time of sale in accordance with TI's standard warranty. Testing and other quality control techniques are used to the extent TI deems necessary to support this warranty. Except where mandated by government requirements, testing of all parameters of each product is not necessarily performed.

TI assumes no liability for applications assistance or customer product design. Customers are responsible for their products and applications using TI components. To minimize the risks associated with customer products and applications, customers should provide adequate design and operating safeguards.

TI does not warrant or represent that any license, either express or implied, is granted under any TI patent right, copyright, mask work right, or other TI intellectual property right relating to any combination, machine, or process in which TI products or services are used. Information published by TI regarding third-party products or services does not constitute a license from TI to use such products or services or a warranty or endorsement thereof. Use of such information may require a license from a third party under the patents or other intellectual property of the third party, or a license from TI under the patents or other intellectual property of TI.

Reproduction of information in TI data books or data sheets is permissible only if reproduction is without alteration and is accompanied by all associated warranties, conditions, limitations, and notices. Reproduction of this information with alteration is an unfair and deceptive business practice. TI is not responsible or liable for such altered documentation.

Resale of TI products or services with statements different from or beyond the parameters stated by TI for that product or service voids all express and any implied warranties for the associated TI product or service and is an unfair and deceptive business practice. TI is not responsible or liable for any such statements.

Following are URLs where you can obtain information on other Texas Instruments products and application solutions:

<b>Products</b>		<b>Applications</b>	
Amplifiers	<a href="http://amplifier.ti.com">amplifier.ti.com</a>	Audio	<a href="http://www.ti.com/audio">www.ti.com/audio</a>
Data Converters	<a href="http://dataconverter.ti.com">dataconverter.ti.com</a>	Automotive	<a href="http://www.ti.com/automotive">www.ti.com/automotive</a>
DSP	<a href="http://dsp.ti.com">dsp.ti.com</a>	Broadband	<a href="http://www.ti.com/broadband">www.ti.com/broadband</a>
Interface	<a href="http://interface.ti.com">interface.ti.com</a>	Digital Control	<a href="http://www.ti.com/digitalcontrol">www.ti.com/digitalcontrol</a>
Logic	<a href="http://logic.ti.com">logic.ti.com</a>	Military	<a href="http://www.ti.com/military">www.ti.com/military</a>
Power Mgmt	<a href="http://power.ti.com">power.ti.com</a>	Optical Networking	<a href="http://www.ti.com/opticalnetwork">www.ti.com/opticalnetwork</a>
Microcontrollers	<a href="http://microcontroller.ti.com">microcontroller.ti.com</a>	Security	<a href="http://www.ti.com/security">www.ti.com/security</a>
		Telephony	<a href="http://www.ti.com/telephony">www.ti.com/telephony</a>
		Video & Imaging	<a href="http://www.ti.com/video">www.ti.com/video</a>
		Wireless	<a href="http://www.ti.com/wireless">www.ti.com/wireless</a>

Mailing Address: Texas Instruments  
Post Office Box 655303 Dallas, Texas 75265