

CD4001B, CD4002B, CD4025B Types

CMOS NOR Gates

High-Voltage Types (20-Volt Rating)

Quad 2 Input – CD4001B

Dual 4 Input – CD4002B

Triple 3 Input – CD4025B

■ CD4001B, CD4002B, and CD4025B NOR gates provide the system designer with direct implementation of the NOR function and supplement the existing family of CMOS gates. All inputs and outputs are buffered.

The CD4001B, CD4002B, and CD4025B types are supplied in 14-lead hermetic dual-in-line ceramic packages (F3A suffix), 14-lead dual-in-line plastic packages (E suffix), 14-lead small-outline packages (M, MT, M96, and NSR suffixes), and 14-lead thin shrink small-outline packages (PW and PWR suffixes).

Features:

- Propagation delay time = 60 ns (typ.) at $C_L = 50 \text{ pF}$, $V_{DD} = 10 \text{ V}$
- Buffered inputs and outputs
- Standardized symmetrical output characteristics
- 100% tested for maximum quiescent current at 20 V
- 5-V, 10-V, and 15-V parametric ratings
- Maximum input current of $1 \mu\text{A}$ at 18 V over full package-temperature range; 100 nA at 18 V and 25°C
- Noise margin (over full package temperature range):
 - 1 V at $V_{DD} = 5 \text{ V}$
 - 2 V at $V_{DD} = 10 \text{ V}$
 - 2.5 V at $V_{DD} = 15 \text{ V}$
- Meets all requirements of JEDEC Tentative Standard No. 13B, "Standard Specifications for Description of "B" Series CMOS Devices"

STATIC ELECTRICAL CHARACTERISTICS

CHARACTER- ISTIC	CONDITIONS			LIMITS AT INDICATED TEMPERATURES ($^\circ\text{C}$)							UNITS
	V_O (V)	V_{IN} (V)	V_{DD} (V)	+25							
				-55	-40	+85	+125	Min.	Typ.	Max.	
Quiescent Device Current, $I_{DD} \text{ Max.}$	–	0,5	5	0,25	0,25	7,5	7,5	–	0,01	0,25	μA
	–	0,10	10	0,5	0,5	15	15	–	0,01	0,5	
	–	0,15	15	1	1	30	30	–	0,01	1	
	–	0,20	20	5	5	150	150	–	0,02	5	
Output Low (Sink) Current $I_{OL} \text{ Min.}$	0,4	0,5	5	0,64	0,61	0,42	0,36	0,51	1	–	mA
	0,5	0,10	10	1,6	1,5	1,1	0,9	1,3	2,6	–	
	1,5	0,15	15	4,2	4	2,8	2,4	3,4	6,8	–	
	–	0,20	20	5	5	150	150	–	0,02	5	
Output High (Source) Current, $I_{OH} \text{ Min.}$	4,6	0,5	5	-0,64	-0,61	-0,42	-0,36	-0,51	-1	–	mA
	2,5	0,5	5	-2	-1,8	-1,3	-1,15	-1,6	-3,2	–	
	9,5	0,10	10	-1,6	-1,5	-1,1	-0,9	-1,3	-2,6	–	
	13,5	0,15	15	-4,2	-4	-2,8	-2,4	-3,4	-6,8	–	
Output Voltage: Low-Level, $V_{OL} \text{ Max.}$	–	0,5	5	0,05				–	0	0,05	V
	–	0,10	10	0,05				–	0	0,05	
	–	0,15	15	0,05				–	0	0,05	
Output Voltage: High-Level, $V_{OH} \text{ Min.}$	–	0,5	5	4,95				4,95	5	–	V
	–	0,10	10	9,95				9,95	10	–	
	–	0,15	15	14,95				14,95	15	–	
Input Low Voltage, $V_{IL} \text{ Max.}$	0,5,4,5	–	5	1,5				–	–	1,5	V
	1,9	–	10	3				–	–	3	
	1,5,13,5	–	15	4				–	–	4	
Input High Voltage, $V_{IH} \text{ Min.}$	0,5	–	5	3,5				3,5	–	–	V
	1	–	10	7				7	–	–	
	1,5	–	15	11				11	–	–	
Input Current $I_{IN} \text{ Max.}$		0,18	18	$\pm 0,1$	$\pm 0,1$	± 1	± 1	–	$\pm 10^{-5}$	$\pm 0,1$	μA

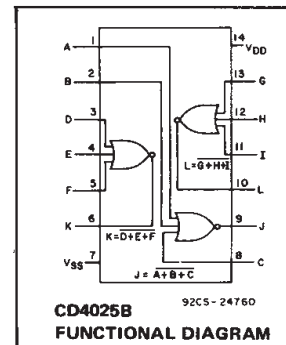
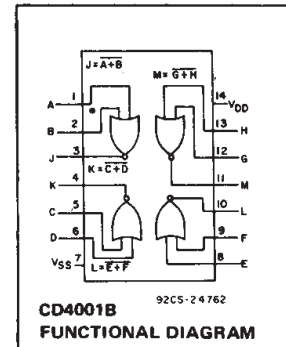

3
COMMERCIAL CMOS
HIGH VOLTAGE ICs

CD4001B, CD4002B, CD4025B Types

RECOMMENDED OPERATING CONDITIONS

For maximum reliability, nominal operating conditions should be selected so that operation is always within the following ranges:

CHARACTERISTIC	LIMITS		UNITS
	MIN.	MAX.	
Supply-Voltage Range (For T_A = Full Package Temperature Range)	3	18	V

MAXIMUM RATINGS, Absolute-Maximum Values:

DC SUPPLY-VOLTAGE RANGE, (V_{DD})

Voltages referenced to V_{SS} Terminal -0.5V to +20V

INPUT VOLTAGE RANGE, ALL INPUTS

..... -0.5V to V_{DD} + 0.5V

DC INPUT CURRENT, ANY ONE INPUT

..... ± 10 mA

POWER DISSIPATION PER PACKAGE (P_D):

For $T_A = -55^\circ\text{C}$ to $+100^\circ\text{C}$ 500mW

For $T_A = +100^\circ\text{C}$ to $+125^\circ\text{C}$ Derate Linearly at 12mW/ $^\circ\text{C}$ to 200mW

DEVICE DISSIPATION PER OUTPUT TRANSISTOR

FOR T_A = FULL PACKAGE-TEMPERATURE RANGE (All Package Types) 100mW

OPERATING-TEMPERATURE RANGE (T_A)

..... -55°C to $+125^\circ\text{C}$

STORAGE TEMPERATURE RANGE (T_{stg})

..... -65°C to $+150^\circ\text{C}$

LEAD TEMPERATURE (DURING SOLDERING):

At distance 1/16 \pm 1/32 inch (1.59 \pm 0.79mm) from case for 10s max $+265^\circ\text{C}$

DYNAMIC ELECTRICAL CHARACTERISTICS

At $T_A = 25^\circ\text{C}$; Input $t_r, t_f = 20$ ns, $C_L = 50$ pF, $R_L = 200k\Omega$

CHARACTERISTIC	TEST CONDITIONS	ALL TYPES LIMITS		UNITS	
		V_{DD} VOLTS	TYP.		MAX.
Propagation Delay Time, t_{PHL}, t_{PLH}		5	125	250	ns
		10	60	120	
		15	45	90	
Transition Time, t_{THL}, t_{TLH}		5	100	200	ns
		10	50	100	
		15	40	80	
Input Capacitance, C_{IN}	Any Input		5	7.5	pF



Fig. 1 - Typical voltage transfer characteristics.

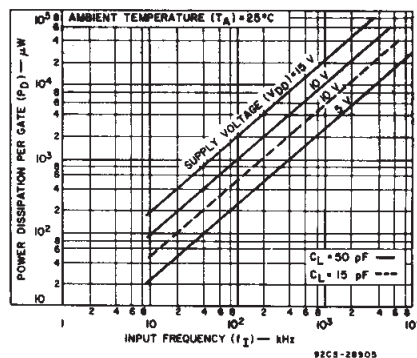

Fig. 2 - Typical power dissipation vs. frequency.

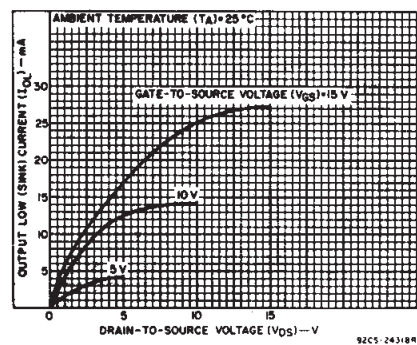

Fig. 3 - Typical output low (sink) current characteristics.

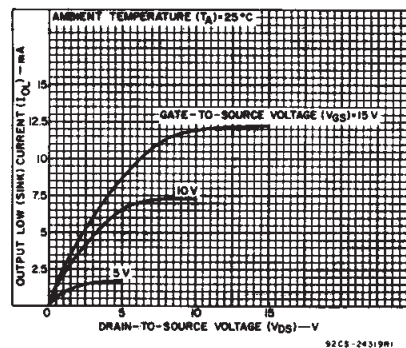

Fig. 4 - Minimum output low (sink) current characteristics.

CD4001B, CD4002B, CD4025B Types

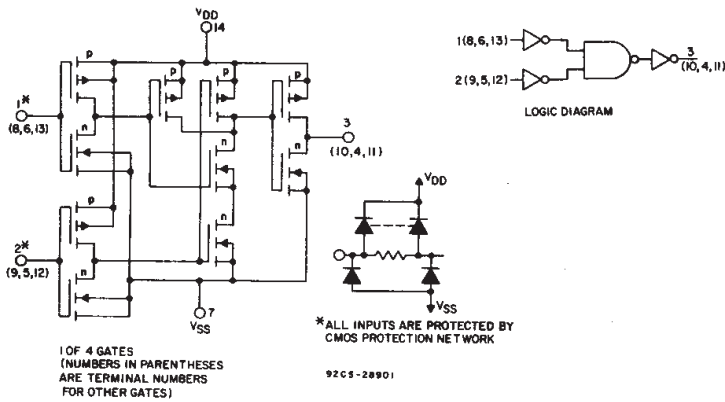

Fig.5 - Schematic and logic diagrams for CD4001B.

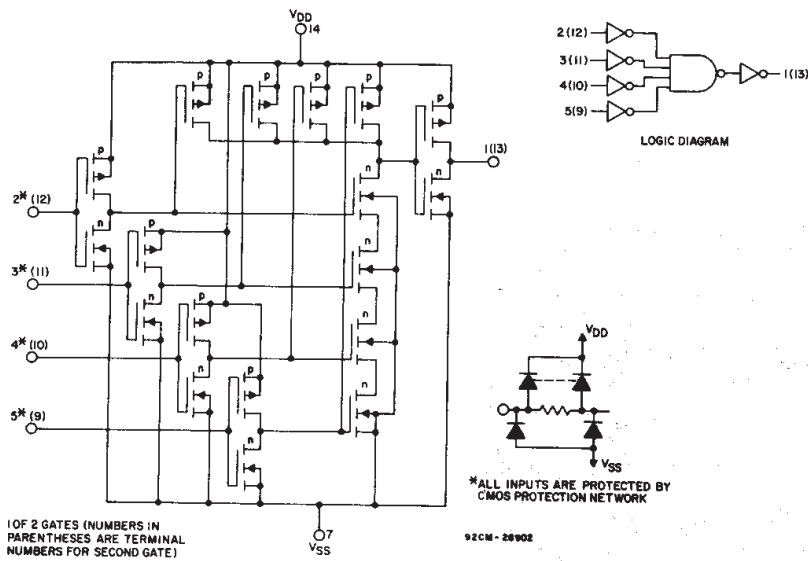

Fig.6 - Schematic and logic diagrams for CD4002B.



Fig.7 - Schematic and logic diagrams for CD4025B.

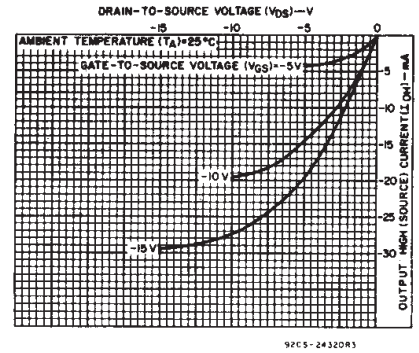

Fig.8 - Typical output high (source) current characteristics.

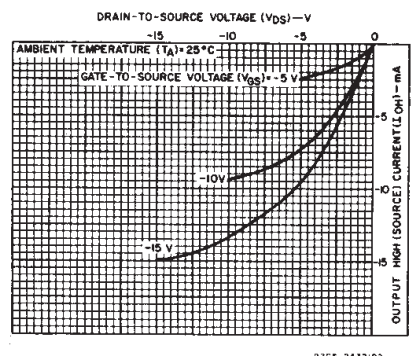

Fig.9 - Minimum output high (source) current characteristics.

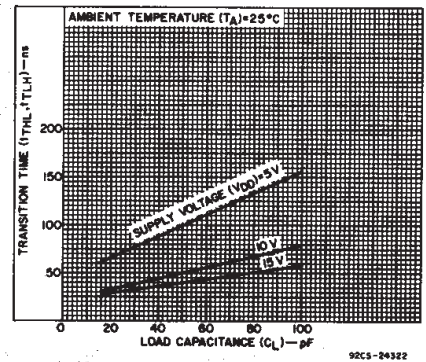

Fig.10 - Typical transition time vs. load capacitance.

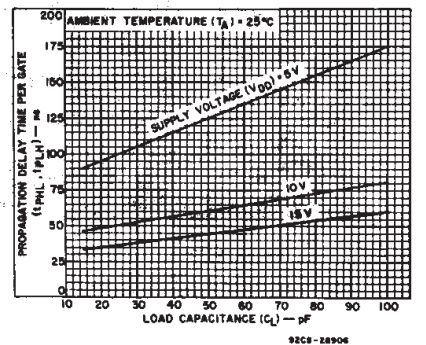

Fig.11 - Typical propagation delay time vs. load capacitance.

COMMERCIAL CMOS HIGH VOLTAGE ICs

CD4001B, CD4002B, CD4025B Types



Fig. 13 - Input leakage current test circuit.

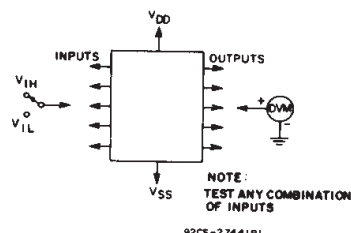

Fig. 14 - Input-voltage test circuit.

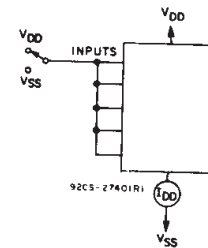
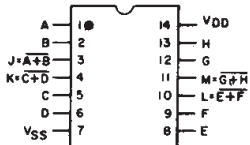

Fig. 15 - Quiescent-device current test circuit.

TERMINAL ASSIGNMENTS (TOP VIEW)



NC = NO CONNECTION

CD4001B

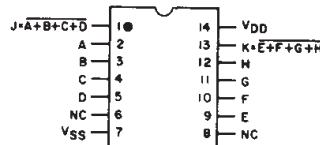

NC = NO CONNECTION

CD4002B

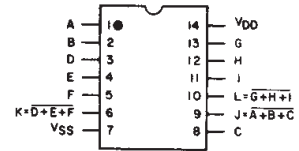

NC = NO CONNECTION

CD4025B

Chip Dimensions and Pad Layouts

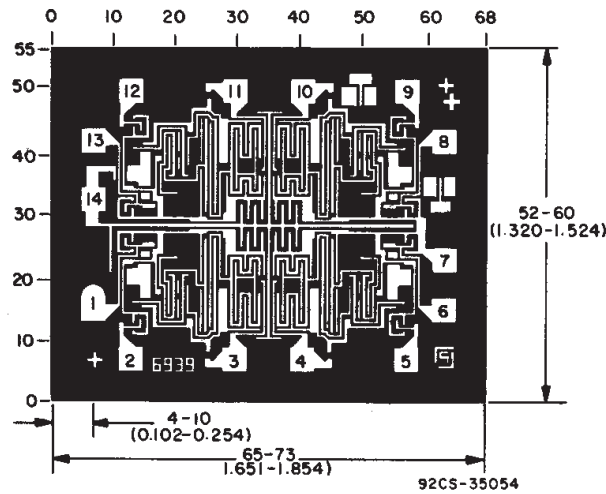

CD4001B

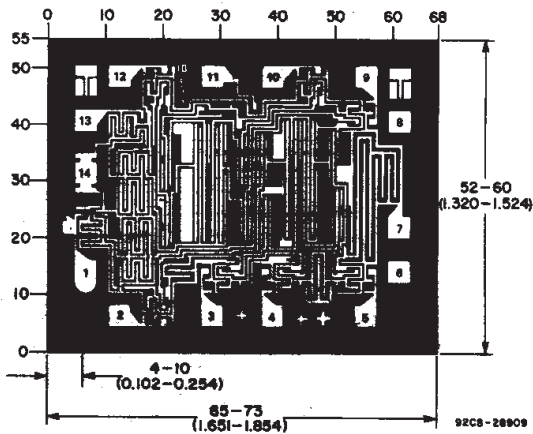

CD4002B

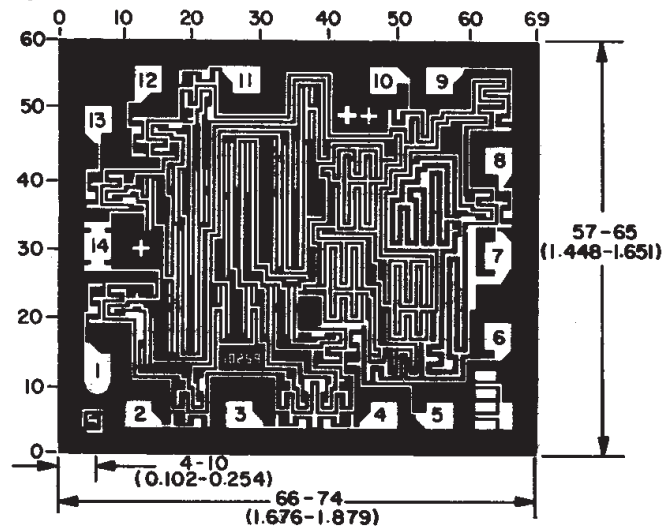

CD4025B

PACKAGING INFORMATION

Orderable Device	Status ⁽¹⁾	Package Type	Package Drawing	Pins	Package Qty	Eco Plan ⁽²⁾	Lead/Ball Finish	MSL Peak Temp ⁽³⁾
7704403CA	ACTIVE	CDIP	J	14	1	None	Call TI	Level-NC-NC-NC
89263AKB3T	OBSOLETE	CFP	WR	16		None	Call TI	Call TI
CD4001BE	ACTIVE	PDIP	N	14	25	Pb-Free (RoHS)	CU NIPDAU	Level-NC-NC-NC
CD4001BF	ACTIVE	CDIP	J	14	1	None	Call TI	Level-NC-NC-NC
CD4001BF3A	ACTIVE	CDIP	J	14	1	None	Call TI	Level-NC-NC-NC
CD4001BM	ACTIVE	SOIC	D	14	50	Pb-Free (RoHS)	CU NIPDAU	Level-2-260C-1 YEAR/ Level-1-235C-UNLIM
CD4001BM96	ACTIVE	SOIC	D	14	2500	Pb-Free (RoHS)	CU NIPDAU	Level-2-260C-1 YEAR/ Level-1-235C-UNLIM
CD4001BMT	ACTIVE	SOIC	D	14	250	Pb-Free (RoHS)	CU NIPDAU	Level-2-260C-1 YEAR/ Level-1-235C-UNLIM
CD4001BNSR	ACTIVE	SO	NS	14	2000	Pb-Free (RoHS)	CU NIPDAU	Level-2-260C-1 YEAR/ Level-1-235C-UNLIM
CD4001BPW	ACTIVE	TSSOP	PW	14	90	Pb-Free (RoHS)	CU NIPDAU	Level-1-250C-UNLIM
CD4001BPWR	ACTIVE	TSSOP	PW	14	2000	Pb-Free (RoHS)	CU NIPDAU	Level-1-250C-UNLIM
CD4002BE	ACTIVE	PDIP	N	14	25	Pb-Free (RoHS)	CU NIPDAU	Level-NC-NC-NC
CD4002BF	ACTIVE	CDIP	J	14	1	None	Call TI	Level-NC-NC-NC
CD4002BF3A	ACTIVE	CDIP	J	14	1	None	Call TI	Level-NC-NC-NC
CD4002BM	ACTIVE	SOIC	D	14	50	Pb-Free (RoHS)	CU NIPDAU	Level-2-260C-1 YEAR/ Level-1-235C-UNLIM
CD4002BM96	ACTIVE	SOIC	D	14	2500	Pb-Free (RoHS)	CU NIPDAU	Level-2-260C-1 YEAR/ Level-1-235C-UNLIM
CD4002BMT	ACTIVE	SOIC	D	14	250	Pb-Free (RoHS)	CU NIPDAU	Level-2-260C-1 YEAR/ Level-1-235C-UNLIM
CD4002BNSR	ACTIVE	SO	NS	14	2000	Pb-Free (RoHS)	CU NIPDAU	Level-2-260C-1 YEAR/ Level-1-235C-UNLIM
CD4002BPW	ACTIVE	TSSOP	PW	14	90	Pb-Free (RoHS)	CU NIPDAU	Level-1-250C-UNLIM
CD4002BPWR	ACTIVE	TSSOP	PW	14	2000	Pb-Free (RoHS)	CU NIPDAU	Level-1-250C-UNLIM
CD4025BE	ACTIVE	PDIP	N	14	25	Pb-Free (RoHS)	CU NIPDAU	Level-NC-NC-NC
CD4025BF	ACTIVE	CDIP	J	14	1	None	Call TI	Level-NC-NC-NC
CD4025BF3A	ACTIVE	CDIP	J	14	1	None	Call TI	Level-NC-NC-NC
CD4025BM	ACTIVE	SOIC	D	14	50	Pb-Free (RoHS)	CU NIPDAU	Level-2-260C-1 YEAR/ Level-1-235C-UNLIM
CD4025BM96	ACTIVE	SOIC	D	14	2500	Pb-Free (RoHS)	CU NIPDAU	Level-2-260C-1 YEAR/ Level-1-235C-UNLIM
CD4025BMT	ACTIVE	SOIC	D	14	250	Pb-Free (RoHS)	CU NIPDAU	Level-2-260C-1 YEAR/ Level-1-235C-UNLIM
CD4025BNSR	ACTIVE	SO	NS	14	2000	Pb-Free (RoHS)	CU NIPDAU	Level-2-260C-1 YEAR/ Level-1-235C-UNLIM
CD4025BPW	ACTIVE	TSSOP	PW	14	90	Pb-Free (RoHS)	CU NIPDAU	Level-1-250C-UNLIM

Orderable Device	Status ⁽¹⁾	Package Type	Package Drawing	Pins	Package Qty	Eco Plan ⁽²⁾	Lead/Ball Finish	MSL Peak Temp ⁽³⁾
CD4025BPWR	ACTIVE	TSSOP	PW	14	2000	Pb-Free (RoHS)	CU NIPDAU	Level-1-250C-UNLIM
JM38510/05252BCA	ACTIVE	CDIP	J	14	1	None	Call TI	Level-NC-NC-NC
JM38510/05254BCA	ACTIVE	CDIP	J	14	1	None	Call TI	Level-NC-NC-NC

⁽¹⁾ The marketing status values are defined as follows:

ACTIVE: Product device recommended for new designs.

LIFEBUY: TI has announced that the device will be discontinued, and a lifetime-buy period is in effect.

NRND: Not recommended for new designs. Device is in production to support existing customers, but TI does not recommend using this part in a new design.

PREVIEW: Device has been announced but is not in production. Samples may or may not be available.

OBSOLETE: TI has discontinued the production of the device.

⁽²⁾ Eco Plan - May not be currently available - please check <http://www.ti.com/productcontent> for the latest availability information and additional product content details.

None: Not yet available Lead (Pb-Free).

Pb-Free (RoHS): TI's terms "Lead-Free" or "Pb-Free" mean semiconductor products that are compatible with the current RoHS requirements for all 6 substances, including the requirement that lead not exceed 0.1% by weight in homogeneous materials. Where designed to be soldered at high temperatures, TI Pb-Free products are suitable for use in specified lead-free processes.

Green (RoHS & no Sb/Br): TI defines "Green" to mean "Pb-Free" and in addition, uses package materials that do not contain halogens, including bromine (Br) or antimony (Sb) above 0.1% of total product weight.

⁽³⁾ MSL, Peak Temp. -- The Moisture Sensitivity Level rating according to the JEDEC industry standard classifications, and peak solder temperature.

Important Information and Disclaimer: The information provided on this page represents TI's knowledge and belief as of the date that it is provided. TI bases its knowledge and belief on information provided by third parties, and makes no representation or warranty as to the accuracy of such information. Efforts are underway to better integrate information from third parties. TI has taken and continues to take reasonable steps to provide representative and accurate information but may not have conducted destructive testing or chemical analysis on incoming materials and chemicals. TI and TI suppliers consider certain information to be proprietary, and thus CAS numbers and other limited information may not be available for release.

In no event shall TI's liability arising out of such information exceed the total purchase price of the TI part(s) at issue in this document sold by TI to Customer on an annual basis.

J (R-GDIP-T**)

14 LEADS SHOWN

CERAMIC DUAL IN-LINE PACKAGE

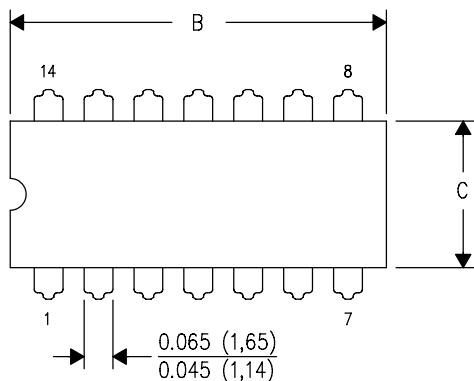

DIM \ PINS **	14	16	18	20
A	0.300 (7,62) BSC	0.300 (7,62) BSC	0.300 (7,62) BSC	0.300 (7,62) BSC
B MAX	0.785 (19,94)	.840 (21,34)	0.960 (24,38)	1.060 (26,92)
B MIN	—	—	—	—
C MAX	0.300 (7,62)	0.300 (7,62)	0.310 (7,87)	0.300 (7,62)
C MIN	0.245 (6,22)	0.245 (6,22)	0.220 (5,59)	0.245 (6,22)

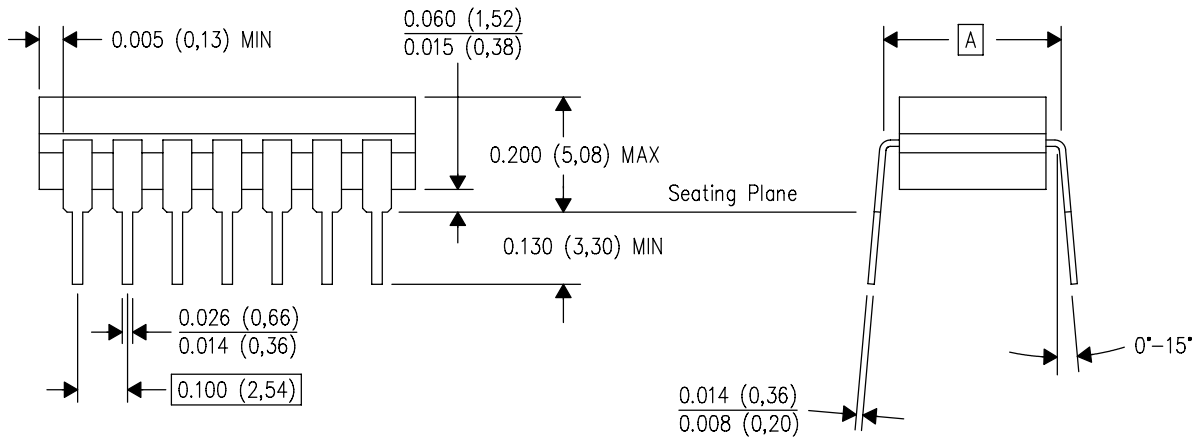

4040083/F 03/03

- NOTES:
- A. All linear dimensions are in inches (millimeters).
 - B. This drawing is subject to change without notice.
 - C. This package is hermetically sealed with a ceramic lid using glass frit.
 - D. Index point is provided on cap for terminal identification only on press ceramic glass frit seal only.
 - E. Falls within MIL STD 1835 GDIP1-T14, GDIP1-T16, GDIP1-T18 and GDIP1-T20.

N (R-PDIP-T**)

PLASTIC DUAL-IN-LINE PACKAGE

16 PINS SHOWN



- NOTES:
- A. All linear dimensions are in inches (millimeters).
 - B. This drawing is subject to change without notice.
 - $\triangle C$ Falls within JEDEC MS-001, except 18 and 20 pin minimum body length (Dim A).
 - $\triangle D$ The 20 pin end lead shoulder width is a vendor option, either half or full width.

D (R-PDSO-G14)

PLASTIC SMALL-OUTLINE PACKAGE



- NOTES:
- A. All linear dimensions are in inches (millimeters).
 - B. This drawing is subject to change without notice.
 - C. Body dimensions do not include mold flash or protrusion not to exceed 0.006 (0,15).
 - D. Falls within JEDEC MS-012 variation AB.

MECHANICAL DATA

NS (R-PDSO-G**)

PLASTIC SMALL-OUTLINE PACKAGE

14-PINS SHOWN



- NOTES:
- A. All linear dimensions are in millimeters.
 - B. This drawing is subject to change without notice.
 - C. Body dimensions do not include mold flash or protrusion, not to exceed 0,15.

PW (R-PDSO-G**)

PLASTIC SMALL-OUTLINE PACKAGE

14 PINS SHOWN



4040064/F 01/97

- NOTES: A. All linear dimensions are in millimeters.
 B. This drawing is subject to change without notice.
 C. Body dimensions do not include mold flash or protrusion not to exceed 0,15.
 D. Falls within JEDEC MO-153

IMPORTANT NOTICE

Texas Instruments Incorporated and its subsidiaries (TI) reserve the right to make corrections, modifications, enhancements, improvements, and other changes to its products and services at any time and to discontinue any product or service without notice. Customers should obtain the latest relevant information before placing orders and should verify that such information is current and complete. All products are sold subject to TI's terms and conditions of sale supplied at the time of order acknowledgment.

TI warrants performance of its hardware products to the specifications applicable at the time of sale in accordance with TI's standard warranty. Testing and other quality control techniques are used to the extent TI deems necessary to support this warranty. Except where mandated by government requirements, testing of all parameters of each product is not necessarily performed.

TI assumes no liability for applications assistance or customer product design. Customers are responsible for their products and applications using TI components. To minimize the risks associated with customer products and applications, customers should provide adequate design and operating safeguards.

TI does not warrant or represent that any license, either express or implied, is granted under any TI patent right, copyright, mask work right, or other TI intellectual property right relating to any combination, machine, or process in which TI products or services are used. Information published by TI regarding third-party products or services does not constitute a license from TI to use such products or services or a warranty or endorsement thereof. Use of such information may require a license from a third party under the patents or other intellectual property of the third party, or a license from TI under the patents or other intellectual property of TI.

Reproduction of information in TI data books or data sheets is permissible only if reproduction is without alteration and is accompanied by all associated warranties, conditions, limitations, and notices. Reproduction of this information with alteration is an unfair and deceptive business practice. TI is not responsible or liable for such altered documentation.

Resale of TI products or services with statements different from or beyond the parameters stated by TI for that product or service voids all express and any implied warranties for the associated TI product or service and is an unfair and deceptive business practice. TI is not responsible or liable for any such statements.

Following are URLs where you can obtain information on other Texas Instruments products and application solutions:

Products		Applications	
Amplifiers	amplifier.ti.com	Audio	www.ti.com/audio
Data Converters	dataconverter.ti.com	Automotive	www.ti.com/automotive
DSP	dsp.ti.com	Broadband	www.ti.com/broadband
Interface	interface.ti.com	Digital Control	www.ti.com/digitalcontrol
Logic	logic.ti.com	Military	www.ti.com/military
Power Mgmt	power.ti.com	Optical Networking	www.ti.com/opticalnetwork
Microcontrollers	microcontroller.ti.com	Security	www.ti.com/security
		Telephony	www.ti.com/telephony
		Video & Imaging	www.ti.com/video
		Wireless	www.ti.com/wireless

Mailing Address: Texas Instruments
Post Office Box 655303 Dallas, Texas 75265