

CD54AC02, CD74AC02 QUADRUPLE 2-INPUT POSITIVE-NOR GATES

SCHS304C – JANUARY 2001 – REVISED JUNE 2002

- AC Types Feature 1.5-V to 5.5-V Operation and Balanced Noise Immunity at 30% of the Supply Voltage
- Speed of Bipolar F, AS, and S, With Significantly Reduced Power Consumption
- Balanced Propagation Delays
- ± 24 -mA Output Drive Current
– Fanout to 15 F Devices
- SCR-Latchup-Resistant CMOS Process and Circuit Design
- Exceeds 2-kV ESD Protection Per MIL-STD-883, Method 3015

CD54AC02 . . . F PACKAGE
CD74AC02 . . . E OR M PACKAGE
(TOP VIEW)

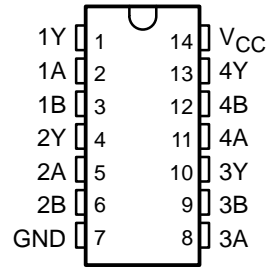

description

The 'AC02 devices contain four independent 2-input NOR gates that perform the Boolean function $Y = \overline{A} \cdot \overline{B}$ or $Y = \overline{A + B}$ in positive logic.

ORDERING INFORMATION

T _A	PACKAGE†		ORDERABLE PART NUMBER	TOP-SIDE MARKING
–55°C to 125°C	PDIP – E	Tube	CD74AC02E	CD74AC02E
	SOIC – M	Tube	CD74AC02M	AC02M
		Tape and reel	CD74AC02M96	
	CDIP – F	Tube	CD54AC02F3A	CD54AC02F3A

† Package drawings, standard packing quantities, thermal data, symbolization, and PCB design guidelines are available at www.ti.com/sc/package.

FUNCTION TABLE (each gate)

INPUTS		OUTPUT
A	B	Y
H	X	L
X	H	L
L	L	H

logic diagram (positive logic)

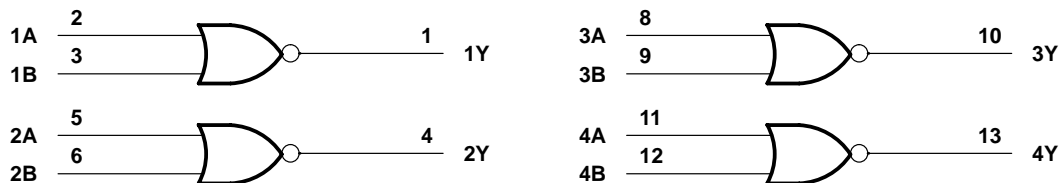

Please be aware that an important notice concerning availability, standard warranty, and use in critical applications of Texas Instruments semiconductor products and disclaimers thereto appears at the end of this data sheet.

PRODUCTION DATA information is current as of publication date. Products conform to specifications per the terms of Texas Instruments standard warranty. Production processing does not necessarily include testing of all parameters.

 **TEXAS
INSTRUMENTS**

POST OFFICE BOX 655303 • DALLAS, TEXAS 75265

Copyright © 2002, Texas Instruments Incorporated
On products compliant to MIL-PRF-38535, all parameters are tested unless otherwise noted. On all other products, production processing does not necessarily include testing of all parameters.

CD54AC02, CD74AC02 QUADRUPLE 2-INPUT POSITIVE-NOR GATES

SCHS304C – JANUARY 2001 – REVISED JUNE 2002

absolute maximum ratings over operating free-air temperature range (unless otherwise noted)†

Supply voltage range, V_{CC}	-0.5 V to 6 V
Input clamp current, I_{IK} ($V_I < 0$ or $V_I > V_{CC}$) (see Note 1)	± 20 mA
Output clamp current, I_{OK} ($V_O < 0$ or $V_O > V_{CC}$) (see Note 1)	± 50 mA
Continuous output current, I_O ($V_O = 0$ to V_{CC})	± 50 mA
Continuous current through V_{CC} or GND	± 100 mA
Package thermal impedance, θ_{JA} (see Note 2): E package	80°C/W
M package	86°C/W
Storage temperature range, T_{stg}	-65°C to 150°C

† Stresses beyond those listed under “absolute maximum ratings” may cause permanent damage to the device. These are stress ratings only, and functional operation of the device at these or any other conditions beyond those indicated under “recommended operating conditions” is not implied. Exposure to absolute-maximum-rated conditions for extended periods may affect device reliability.

- NOTES: 1. The input and output voltage ratings may be exceeded if the input and output current ratings are observed.
2. The package thermal impedance is calculated in accordance with JESD 51-7.

recommended operating conditions (see Note 3)

		$T_A = 25^\circ\text{C}$		$-40^\circ\text{C TO } 85^\circ\text{C}$		$-55^\circ\text{C TO } 125^\circ\text{C}$		UNIT
		MIN	MAX	MIN	MAX	MIN	MAX	
V_{CC}	Supply voltage	1.5	5.5	1.5	5.5	1.5	5.5	V
V_{IH}	High-level input voltage	$V_{CC} = 1.5\text{ V}$		1.2		1.2		V
		$V_{CC} = 3\text{ V}$		2.1		2.1		
		$V_{CC} = 5.5\text{ V}$		3.85		3.85		
V_{IL}	Low-level input voltage	$V_{CC} = 1.5\text{ V}$			0.3		0.3	V
		$V_{CC} = 3\text{ V}$			0.9		0.9	
		$V_{CC} = 5.5\text{ V}$			1.65		1.65	
V_I	Input voltage	0	V_{CC}	0	V_{CC}	0	V_{CC}	V
V_O	Output voltage	0	V_{CC}	0	V_{CC}	0	V_{CC}	V
I_{OH}	High-level output current	$V_{CC} = 4.5\text{ V to } 5.5\text{ V}$		-24		-24		mA
I_{OL}	Low-level output current	$V_{CC} = 4.5\text{ V to } 5.5\text{ V}$		24		24		mA
$\Delta t/\Delta v$	Input transition rise or fall rate	$V_{CC} = 1.5\text{ V to } 3\text{ V}$		50		50		ns/V
		$V_{CC} = 3.6\text{ V to } 5.5\text{ V}$		20		20		

NOTE 3: All unused inputs of the device must be held at V_{CC} or GND to ensure proper device operation. Refer to the TI application report, *Implications of Slow or Floating CMOS Inputs*, literature number SCBA004.



CD54AC02, CD74AC02 QUADRUPLE 2-INPUT POSITIVE-NOR GATES

SCHS304C – JANUARY 2001 – REVISED JUNE 2002

electrical characteristics over recommended operating free-air temperature range (unless otherwise noted)

PARAMETER	TEST CONDITIONS		V _{CC}	T _A = 25°C		–40°C TO 85°C		–55°C TO 125°C		UNIT
				MIN	MAX	MIN	MAX	MIN	MAX	
V _{OH}	V _I = V _{IH} or V _{IL}	I _{OH} = –50 μA	1.5 V	1.4	1.4	1.4			V	
			3 V	2.9	2.9	2.9				
			4.5 V	4.4	4.4	4.4				
		I _{OH} = –4 mA	3 V	2.58	2.48	2.4				
		I _{OH} = –24 mA	4.5 V	3.94	3.8	3.7				
		I _{OH} = –50 mA†	5.5 V			3.85				
V _{OL}	V _I = V _{IH} or V _{IL}	I _{OL} = 50 μA	1.5 V	0.1	0.1	0.1		V		
			3 V	0.1	0.1	0.1				
			4.5 V	0.1	0.1	0.1				
		I _{OL} = 12 mA	3 V	0.36	0.44	0.5				
		I _{OL} = 24 mA	4.5 V	0.36	0.44	0.5				
		I _{OL} = 50 mA†	5.5 V			1.65				
I _I	V _I = V _{CC} or GND	5.5 V		±0.1	±1	±1	μA			
I _{CC}	V _I = V _{CC} or GND, I _O = 0	5.5 V		4	40	80	μA			
C _i				10	10	10	pF			

† Test one output at a time, not exceeding 1-second duration. Measurement is made by forcing indicated current and measuring voltage to minimize power dissipation. Test verifies a minimum 50-Ω transmission-line drive capability at 85°C and 75-Ω transmission-line drive capability at 125°C.

switching characteristics over recommended operating free-air temperature range, V_{CC} = 1.5 V, C_L = 50 pF (unless otherwise noted) (see Figure 1)

PARAMETER	FROM (INPUT)	TO (OUTPUT)	–40°C TO 85°C		–55°C TO 125°C		UNIT
			MIN	MAX	MIN	MAX	
t _{PLH}	A or B	Y		131		144	ns
t _{PHL}			131	144			

switching characteristics over recommended operating free-air temperature range, V_{CC} = 3.3 V ± 0.3 V, C_L = 50 pF (unless otherwise noted) (see Figure 1)

PARAMETER	FROM (INPUT)	TO (OUTPUT)	–40°C TO 85°C		–55°C TO 125°C		UNIT
			MIN	MAX	MIN	MAX	
t _{PLH}	A or B	Y	4.1	14.6	4	16.1	ns
t _{PHL}			4.1	14.6	4	16.1	



CD54AC02, CD74AC02 QUADRUPLE 2-INPUT POSITIVE-NOR GATES

SCHS304C – JANUARY 2001 – REVISED JUNE 2002

switching characteristics over recommended operating free-air temperature range,
 $V_{CC} = 5\text{ V} \pm 0.5\text{ V}$, $C_L = 50\text{ pF}$ (unless otherwise noted) (see Figure 1)

PARAMETER	FROM (INPUT)	TO (OUTPUT)	-40°C TO 85°C		-55°C TO 125°C		UNIT
			MIN	MAX	MIN	MAX	
t _{PLH}	A or B	Y	3	10.4	2.9	11.5	ns
t _{PHL}			3	10.4	2.9	11.5	

operating characteristics, $V_{CC} = 5\text{ V}$, $T_A = 25^\circ\text{C}$

PARAMETER	TYP	UNIT
C _{pd} Power dissipation capacitance	55	pF



PARAMETER MEASUREMENT INFORMATION

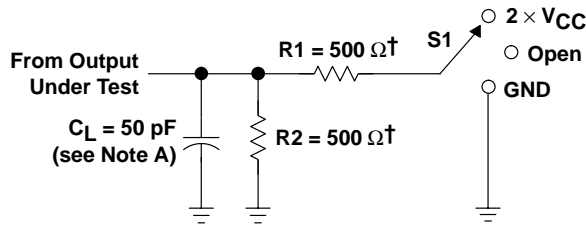

† When $V_{CC} = 1.5\text{ V}$, $R_1 = R_2 = 1\text{ k}\Omega$

LOAD CIRCUIT

TEST	S1
t_{PLH}/t_{PHL}	Open
t_{PLZ}/t_{PZL}	$2 \times V_{CC}$
t_{PHZ}/t_{PZH}	GND

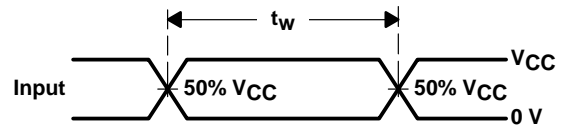

VOLTAGE WAVEFORMS
 PULSE DURATION

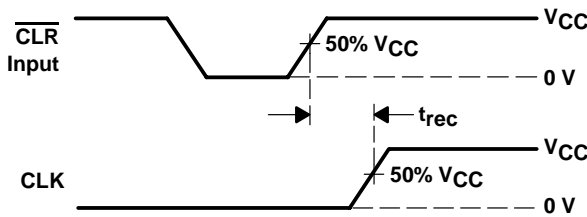

VOLTAGE WAVEFORMS
 RECOVERY TIME

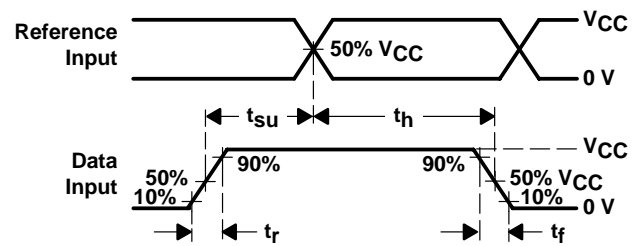

VOLTAGE WAVEFORMS
 SETUP AND HOLD AND INPUT RISE AND FALL TIMES

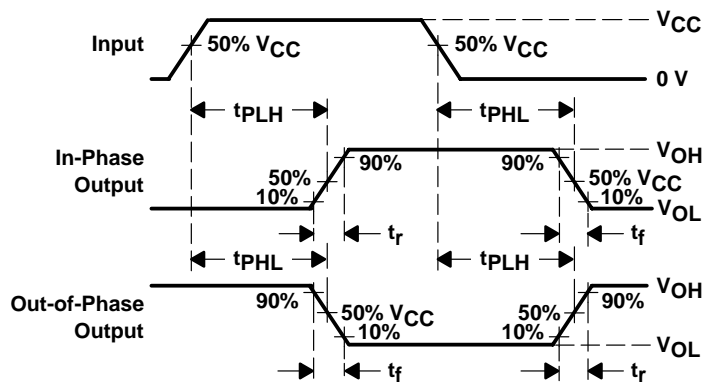

VOLTAGE WAVEFORMS
 PROPAGATION DELAY AND OUTPUT TRANSITION TIMES

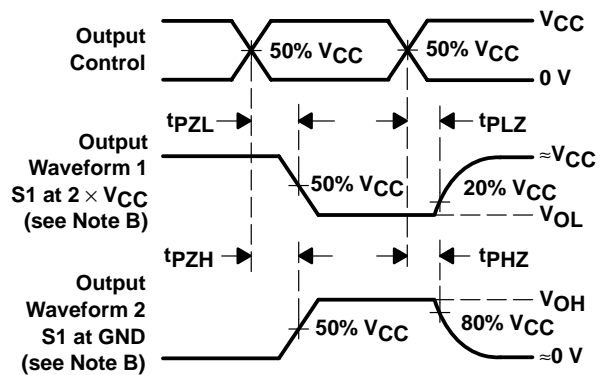

VOLTAGE WAVEFORMS
 OUTPUT ENABLE AND DISABLE TIMES

- NOTES: A. C_L includes probe and test-fixture capacitance.
 B. Waveform 1 is for an output with internal conditions such that the output is low except when disabled by the output control. Waveform 2 is for an output with internal conditions such that the output is high except when disabled by the output control.
 C. All input pulses are supplied by generators having the following characteristics: $PRR \leq 1\text{ MHz}$, $Z_O = 50\ \Omega$, $t_r = 3\text{ ns}$, $t_f = 3\text{ ns}$. Phase relationships between waveforms are arbitrary.
 D. For clock inputs, f_{max} is measured with the input duty cycle at 50%.
 E. The outputs are measured one at a time with one input transition per measurement.
 F. t_{PLH} and t_{PHL} are the same as t_{pd} .
 G. t_{PZL} and t_{PZH} are the same as t_{en} .
 H. t_{PLZ} and t_{PHZ} are the same as t_{dis} .

Figure 1. Load Circuit and Voltage Waveforms

PACKAGING INFORMATION

Orderable Device	Status ⁽¹⁾	Package Type	Package Drawing	Pins	Package Qty	Eco Plan ⁽²⁾	Lead/Ball Finish	MSL Peak Temp ⁽³⁾
CD54AC02F3A	ACTIVE	CDIP	J	14	1	None	Call TI	Level-NC-NC-NC
CD74AC02E	ACTIVE	PDIP	N	14	25	Pb-Free (RoHS)	CU NIPDAU	Level-NC-NC-NC
CD74AC02M	ACTIVE	SOIC	D	14	50	Pb-Free (RoHS)	CU NIPDAU	Level-2-260C-1 YEAR/ Level-1-235C-UNLIM
CD74AC02M96	ACTIVE	SOIC	D	14	2500	Pb-Free (RoHS)	CU NIPDAU	Level-2-260C-1 YEAR/ Level-1-235C-UNLIM

⁽¹⁾ The marketing status values are defined as follows:

ACTIVE: Product device recommended for new designs.

LIFEBUY: TI has announced that the device will be discontinued, and a lifetime-buy period is in effect.

NRND: Not recommended for new designs. Device is in production to support existing customers, but TI does not recommend using this part in a new design.

PREVIEW: Device has been announced but is not in production. Samples may or may not be available.

OBsolete: TI has discontinued the production of the device.

⁽²⁾ Eco Plan - May not be currently available - please check <http://www.ti.com/productcontent> for the latest availability information and additional product content details.

None: Not yet available Lead (Pb-Free).

Pb-Free (RoHS): TI's terms "Lead-Free" or "Pb-Free" mean semiconductor products that are compatible with the current RoHS requirements for all 6 substances, including the requirement that lead not exceed 0.1% by weight in homogeneous materials. Where designed to be soldered at high temperatures, TI Pb-Free products are suitable for use in specified lead-free processes.

Green (RoHS & no Sb/Br): TI defines "Green" to mean "Pb-Free" and in addition, uses package materials that do not contain halogens, including bromine (Br) or antimony (Sb) above 0.1% of total product weight.

⁽³⁾ MSL, Peak Temp. -- The Moisture Sensitivity Level rating according to the JEDEC industry standard classifications, and peak solder temperature.

Important Information and Disclaimer: The information provided on this page represents TI's knowledge and belief as of the date that it is provided. TI bases its knowledge and belief on information provided by third parties, and makes no representation or warranty as to the accuracy of such information. Efforts are underway to better integrate information from third parties. TI has taken and continues to take reasonable steps to provide representative and accurate information but may not have conducted destructive testing or chemical analysis on incoming materials and chemicals. TI and TI suppliers consider certain information to be proprietary, and thus CAS numbers and other limited information may not be available for release.

In no event shall TI's liability arising out of such information exceed the total purchase price of the TI part(s) at issue in this document sold by TI to Customer on an annual basis.

IMPORTANT NOTICE

Texas Instruments Incorporated and its subsidiaries (TI) reserve the right to make corrections, modifications, enhancements, improvements, and other changes to its products and services at any time and to discontinue any product or service without notice. Customers should obtain the latest relevant information before placing orders and should verify that such information is current and complete. All products are sold subject to TI's terms and conditions of sale supplied at the time of order acknowledgment.

TI warrants performance of its hardware products to the specifications applicable at the time of sale in accordance with TI's standard warranty. Testing and other quality control techniques are used to the extent TI deems necessary to support this warranty. Except where mandated by government requirements, testing of all parameters of each product is not necessarily performed.

TI assumes no liability for applications assistance or customer product design. Customers are responsible for their products and applications using TI components. To minimize the risks associated with customer products and applications, customers should provide adequate design and operating safeguards.

TI does not warrant or represent that any license, either express or implied, is granted under any TI patent right, copyright, mask work right, or other TI intellectual property right relating to any combination, machine, or process in which TI products or services are used. Information published by TI regarding third-party products or services does not constitute a license from TI to use such products or services or a warranty or endorsement thereof. Use of such information may require a license from a third party under the patents or other intellectual property of the third party, or a license from TI under the patents or other intellectual property of TI.

Reproduction of information in TI data books or data sheets is permissible only if reproduction is without alteration and is accompanied by all associated warranties, conditions, limitations, and notices. Reproduction of this information with alteration is an unfair and deceptive business practice. TI is not responsible or liable for such altered documentation.

Resale of TI products or services with statements different from or beyond the parameters stated by TI for that product or service voids all express and any implied warranties for the associated TI product or service and is an unfair and deceptive business practice. TI is not responsible or liable for any such statements.

Following are URLs where you can obtain information on other Texas Instruments products and application solutions:

Products		Applications	
Amplifiers	amplifier.ti.com	Audio	www.ti.com/audio
Data Converters	dataconverter.ti.com	Automotive	www.ti.com/automotive
DSP	dsp.ti.com	Broadband	www.ti.com/broadband
Interface	interface.ti.com	Digital Control	www.ti.com/digitalcontrol
Logic	logic.ti.com	Military	www.ti.com/military
Power Mgmt	power.ti.com	Optical Networking	www.ti.com/opticalnetwork
Microcontrollers	microcontroller.ti.com	Security	www.ti.com/security
		Telephony	www.ti.com/telephony
		Video & Imaging	www.ti.com/video
		Wireless	www.ti.com/wireless

Mailing Address: Texas Instruments
Post Office Box 655303 Dallas, Texas 75265