

## DS3695A/DS3695AT/DS3696A Multipoint RS485/RS422 Transceivers

 Check for Samples: [DS3695A](#), [DS3695AT](#), [DS3696A](#)

### FEATURES

- Meets EIA Standard RS485 for Multipoint Bus Transmission and is Compatible with RS-422
- 10 Ns Driver Propagation Delays (Typical)
- Single +5V Supply
- -7V to +12V Bus Common Mode Range Permits  $\pm 7V$  Ground Difference between Devices on the Bus
- Thermal Shutdown Protection
- High Impedance to Bus with Driver in TRI-STATE or with Power Off, over the Entire Common Mode Range Allows the Unused Devices on the Bus to be Powered Down
- Combined Impedance of a Driver Output and Receiver Input is less than One RS485 Unit Load, Allowing up to 32 Transceivers on the Bus
- 70 mV Typical Receiver Hysteresis
- Available in SOIC Packaging

### DESCRIPTION

The DS3695A and DS3696A are high speed differential TRI-STATE bus/line transceivers designed to meet the requirements of EIA standard RS485 with extended common mode range (+12V to -7V), for multipoint data transmission. In addition they are compatible with requirements of RS-422.

The driver and receiver outputs feature TRI-STATE capability. The driver outputs remain in over the entire common mode range of +12V to -7V. Bus faults that cause excessive power dissipation within the device trigger a thermal shutdown circuit, which forces the driver outputs into the high impedance state. The DS3696A provides an output pin (TS) which reports the thermal shutdown of the device. TS is an "open collector" pin with an internal 10 k $\Omega$  pull-up resistor. This allows the TS outputs of several devices to be wire OR-ed.

Both AC and DC specifications are guaranteed over the 0°C to 70°C temperature and 4.75V to 5.25V supply voltage range.

### Connection and Logic Diagrams

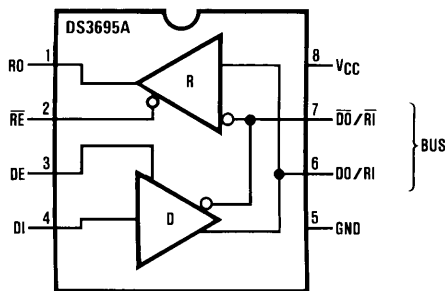

Figure 1. Molded Package, Small Outline (D0008A)  
Top View

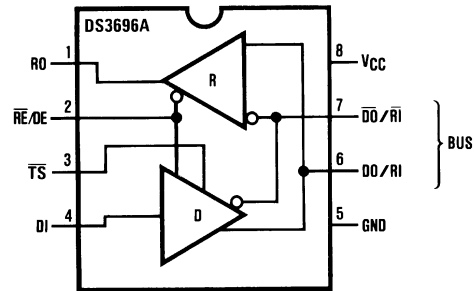

Figure 2. Top View  
(See Package Number D0008A)

$\overline{TS}$  was  $\overline{LF}$  (Line Fault) on previous datasheets,  $\overline{TS}$  goes low upon thermal shutdown.



Please be aware that an important notice concerning availability, standard warranty, and use in critical applications of Texas Instruments semiconductor products and disclaimers thereto appears at the end of this data sheet.

All trademarks are the property of their respective owners.



These devices have limited built-in ESD protection. The leads should be shorted together or the device placed in conductive foam during storage or handling to prevent electrostatic damage to the MOS gates.

### Absolute Maximum Ratings <sup>(1)(2)</sup>

Supply Voltage, $V_{CC}$	7V
Control Input Voltages	7V
Driver Input Voltage	7V
Driver Output Voltages	+15V/-10V
Receiver Input Voltages	+15V/-10V
Receiver Output Voltage	5.5V
Continuous Power Dissipation @ 25°C	
D0008A Package	630 mW <sup>(3)</sup>
Storage Temp. Range	-65°C to +150°C
Lead Temp. (Soldering 4 seconds)	260°C

- (1) "Absolute maximum ratings" are those beyond which the safety of the device cannot be verified. They are not meant to imply that the device should be operated at these limits. The tables of "Electrical Characteristics" provide conditions for actual device operation.
- (2) If Military/Aerospace specified devices are required, please contact the Texas Instruments Sales Office/ Distributors for availability and specifications.
- (3) Derate linearly at 6.5 mW/°C to 337 mW at 70°C.

### Recommended Operating Conditions

	Min	Max	Units
Supply Voltage, $V_{CC}$	4.75	5.25	V
Bus Voltage	-7	+12	V
Operating Free Air Temperature ( $T_A$ )			
Commercial (DS3695AM)	0	+70	°C
Industrial (DS3695ATM)	-40	+85	°C
Commercial (DS3696AM)	0	+70	°C

### Electrical Characteristics <sup>(1) (2)</sup>

0°C ≤  $T_A$  ≤ 70°C, 4.75V <  $V_{CC}$  < 5.25V unless otherwise specified

Parameter		Test Conditions	Min	Typ	Max	Units	
$V_{OD1}$	Differential Driver Output Voltage (Unloaded)	$I_O = 0$			5	V	
$V_{OD2}$	Differential Driver Output Voltage (with Load)	$R = 50\Omega$ ; (RS-422) <sup>(3)</sup>	2			V	
		$R = 27\Omega$ ; (RS-485)	1.5			V	
$\Delta V_{OD}$	Complementary Output States Differential Output Voltage For Change in Magnitude of Driver	$R = 27\Omega$			0.2	V	
$V_{OC}$	Driver Common Mode Output Voltage				3.0	V	
$\Delta V_{OC} $	Change in Magnitude of Driver Common Mode Output Voltage For Complementary Output States				0.2	V	
$V_{IH}$	Input High Voltage	$DI, DE, \overline{RE}, RE/DE$	2			V	
$V_{IL}$	Input Low Voltage				0.8	V	
$V_{CL}$	Input Clamp Voltage		$I_{IN} = -18\text{ mA}$			-1.5	V
$I_{IL}$	Input Low Current		$V_{IL} = 0.4V$			-200	μA
$I_{IH}$	Input High Current		$V_{IH} = 2.4V$			20	μA

- (1) All currents into device pins are positive; all currents out of device pins are negative. All voltages are referenced to device ground unless otherwise specified.
- (2) All typicals are given for  $V_{CC} = 5V$  and  $T_A = 25°C$ .
- (3) All limits for which this note is applied must be derated by 10% for DS3695AT. Other parameters remain the same for this extended temperature range device (-40°C ≤  $T_A$  ≤ +85°C).

**Electrical Characteristics <sup>(1)</sup> <sup>(2)</sup> (continued)**
 $0^{\circ}\text{C} \leq T_A \leq 70^{\circ}\text{C}$ ,  $4.75\text{V} < V_{CC} < 5.25\text{V}$  unless otherwise specified

Parameter			Test Conditions	Min	Typ	Max	Units	
$I_{IN}$	Input Current	$\overline{RI}$ , $\overline{RI}$ , DO/RI, DO/RI	$V_{CC} = 0\text{V}$ or $5.25\text{V}$ , DE or $\overline{RE}/\overline{DE} = 0\text{V}$	$V_{IN} = 12\text{V}$		+1.0	mA	
				$V_{IN} = -7\text{V}$		-0.8	mA	
$V_{TH}$	Differential Input Threshold Voltage for Receiver		$-7\text{V} \leq V_{CM} \leq +12\text{V}$	-0.2		+0.2	V	
$\Delta V_{TH}$	Receiver Input Hysteresis		$V_{CM} = 0\text{V}$		70		mV	
$V_{OH}$	Receiver Output High Voltage		$I_{OH} = -400\ \mu\text{A}$	2.4			V	
$V_{OL}$	Output Low Voltage	RO	$I_{OL} = 16\ \text{mA}$ <sup>(3)</sup>			0.5	V	
		$\overline{TS}$	$I_{OL} = 8\ \text{mA}$			0.45	V	
$I_{OZR}$	Output Current at Receiver OFF-State (High Impedance)		$0.4\text{V} \leq V_O \leq 2.4\text{V}$ , $V_{CC} = \text{Max}$ ,			$\pm 20$	$\mu\text{A}$	
$R_{IN}$	Receiver Input Resistance		$-7\text{V} \leq V_{CM} \leq +12\text{V}$	12			k $\Omega$	
$I_{CC}$	Supply Current		No Load <sup>(3)</sup>	Driver Outputs Enabled		42	60	mA
				Driver Outputs Disabled		27	40	mA
$I_{OSD}$	Output Current Driver Short-Circuit		$V_O = -7\text{V}$ <sup>(3)</sup>			-250	mA	
			$V_O = +12\text{V}$ <sup>(3)</sup>			+250	mA	
$I_{OSR}$	Output Current Receiver Short-Circuit		$V_O = 0\text{V}$	-15		-85	mA	

**Receiver Switching Characteristics**
 $0^{\circ}\text{C} \leq T_A \leq 70^{\circ}\text{C}$ ,  $4.75\text{V} < V_{CC} < 5.25\text{V}$  unless otherwise specified <sup>(4)</sup>

Symbol	Test Conditions	Min	Typ	Max	Units
$t_{PLH}$	$C_L = 15\ \text{pF}$	15	28	42	ns
$t_{PHL}$	S1 and S2	15	28	42	ns
$ t_{PLH} - t_{PHL} $	Closed	0	3		ns
$t_{PLZ}$	$C_L = 15\ \text{pF}$ , S2 Open	5	29	35	ns
$t_{PHZ}$	$C_L = 15\ \text{pF}$ , S1 Open	5	12	16	ns
$t_{PZL}$	$C_L = 15\ \text{pF}$ , S2 Open	7	15	28	ns
$t_{PZH}$	$C_L = 15\ \text{pF}$ , S1 Open	7	15	20	ns

<sup>(4)</sup> All typicals are given for  $V_{CC} = 5\text{V}$  and  $T_A = 25^{\circ}\text{C}$ .

**Driver Switching Characteristics**
 $0^{\circ}\text{C} \leq T_A \leq 70^{\circ}\text{C}$ ,  $4.75\text{V} < V_{CC} < 5.25\text{V}$  unless otherwise specified <sup>(1)</sup>

Symbol	Test Conditions	Min	Typ	Max	Units
<b>SINGLE ENDED CHARACTERISTICS</b> (Figure 7, Figure 8, and Figure 10)					
$t_{PLH}$	$R_{LDIFF} = 60\ \Omega$	9	15	22	ns
$t_{PHL}$	$C_{L1} = C_{L2} = 100\ \text{pF}$	9	15	22	ns
$t_{SKEW} t_{PLH} - t_{PHL} $		0	2	8	ns
$t_{PLZ}$	$C_L = 15\ \text{pF}$ , S2 Open	7	15	30	ns
$t_{PHZ}$	$C_L = 15\ \text{pF}$ , S1 Open	7	15	30	ns
$t_{PZL}$	$C_L = 100\ \text{pF}$ , S2 Open	30	35	50	ns
$t_{PZH}$	$C_L = 100\ \text{pF}$ , S1 Open	30	35	50	ns
<b>DIFFERENTIAL SWITCHING CHARACTERISTICS</b> (Figure 10)					
$t_r, t_f$	$R_{LDIFF} = 60\ \Omega$ $C_{L1} = C_{L2} = 100\ \text{pF}$	6	10	18	ns

<sup>(1)</sup> All typicals are given for  $V_{CC} = 5\text{V}$  and  $T_A = 25^{\circ}\text{C}$ .

AC TEST CIRCUITS AND SWITCHING WAVEFORMS

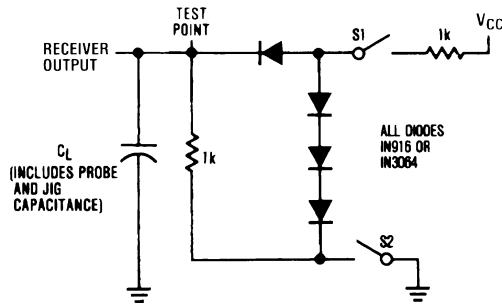
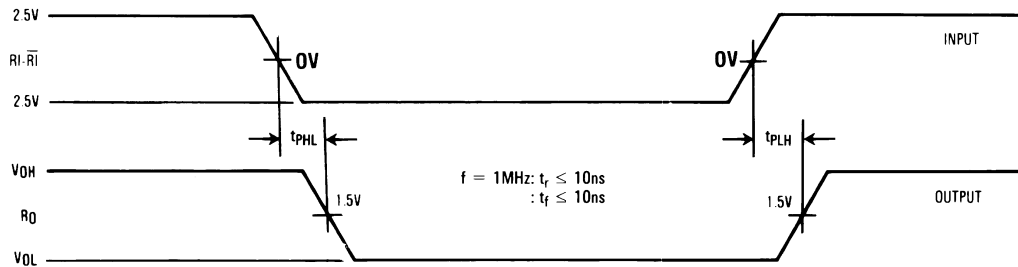

Figure 3. Receiver Propagation Delay Test Circuit



Differential input voltage may be realized by grounding  $\overline{RI}$  and pulsing RI between +2.5V and -2.5V

Figure 4. Receiver Input-to-Output Propagation Delay Timing

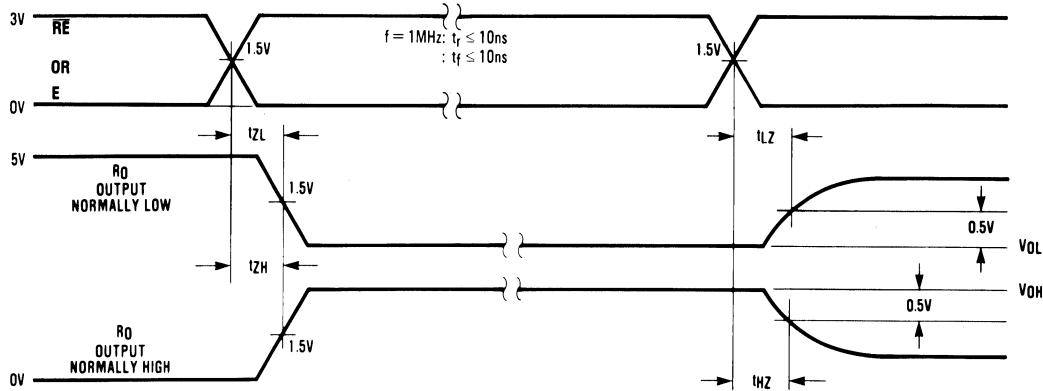

Figure 5. Receiver Enable/Disable Propagation Delay Timing

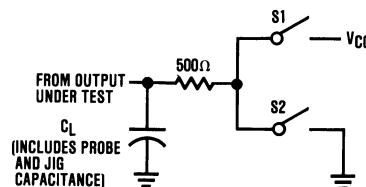

Figure 6. Unless Otherwise Specified the Switches are Closed

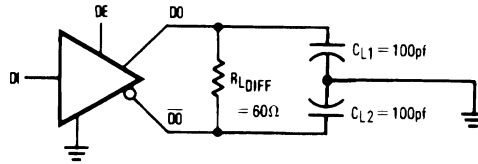
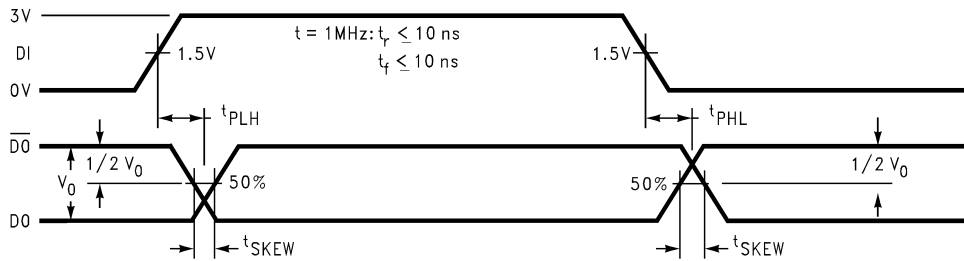

Figure 7. Driver Propagation Delay Test Circuits



$t_{PLH}$  and  $t_{PHL}$  are measured to the respective 50% points.  $t_{SKEW}$  is the difference between propagation delays of the complementary outputs.

Figure 8. Driver Input-to-Output Propagation Delay Timing (Single-Ended)

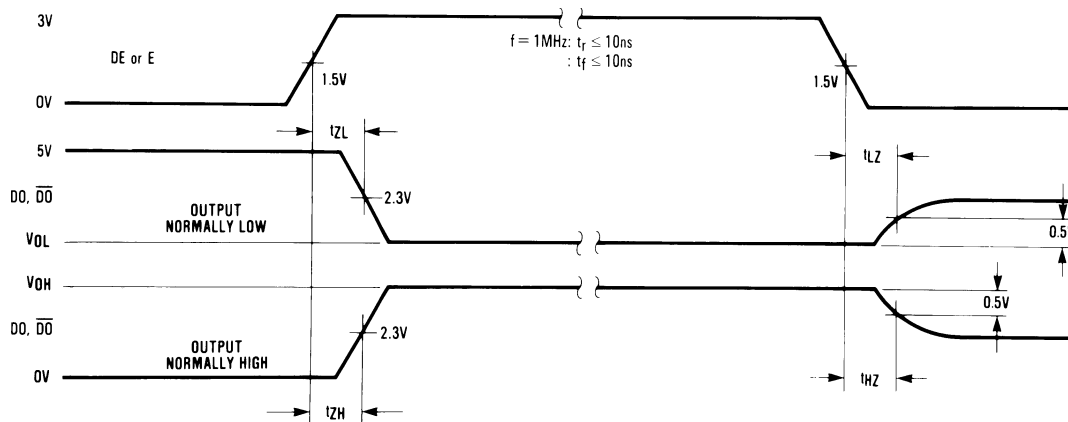

Figure 9. Driver Enable/Disable Propagation Delay Timing

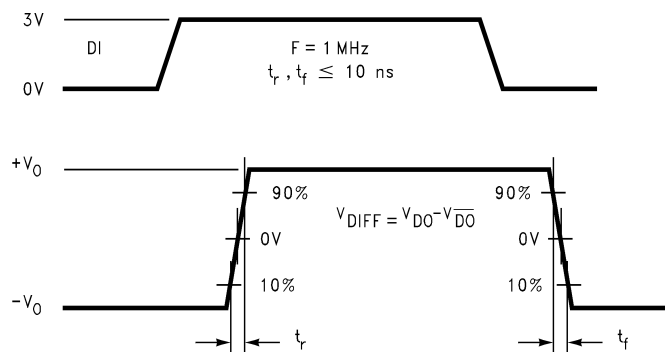

Figure 10. Driver Differential Transition Timing

**Table 1. Function Tables DS3695A/DS3696A Transmitting<sup>(1)</sup>**

Inputs			Line	Outputs		
$\overline{RE}$	DE	DI	Condition	$\overline{DO}$	DO	$\overline{TS}^*$ (DS3696A Only)
X	1	1	No Fault	0	1	H
X	1	0	No Fault	1	0	H
X	0	X	X	Z	Z	H
X	1	X	Fault	Z	Z	L

**Table 2. Function Tables DS3695A/DS3696A Receiving<sup>(1)</sup>**

Inputs			Line	Outputs	
$\overline{RE}$	DE	$RI-\overline{RI}$		RO	$\overline{TS}^*$ (DS3696A Only)
0	0	$\geq +0.2V$		1	H
0	0	$\leq -0.2V$		0	H
0	0	Inputs Open**		1	H
1	0	X		Z	H

- (1) X — Don't care condition  
 Z — High impedance state  
 Fault — Improper line conditions causing excessive power dissipation in the driver, such as shorts or bus contention situations  
 \*  $\overline{TS}$  is an "open collector" output with an on-chip 10 k $\Omega$  pull-up resistor.  
**\*\* This is a fail safe condition**
- (1) X — Don't care condition  
 Z — High impedance state  
 Fault — Improper line conditions causing excessive power dissipation in the driver, such as shorts or bus contention situations  
 \*  $\overline{TS}$  is an "open collector" output with an on-chip 10 k $\Omega$  pull-up resistor.  
**\*\* This is a fail safe condition**

**Typical Application**

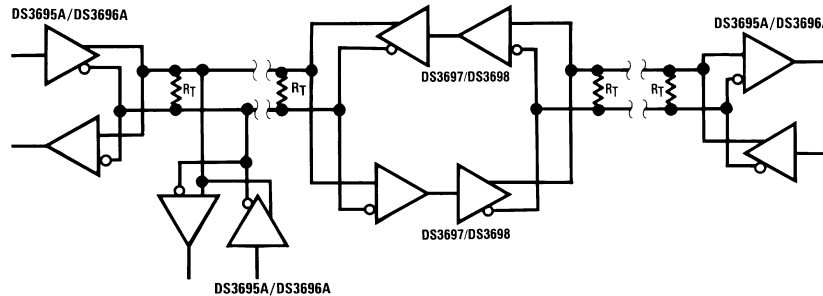

Repeater control logic not shown.

**Figure 11.**

---

**REVISION HISTORY**

<b>Changes from Revision B (April 2013) to Revision C</b>	<b>Page</b>
<hr/> <ul style="list-style-type: none"><li>• Changed layout of National Data Sheet to TI format .....</li></ul>	<hr/> <b>6</b>

**PACKAGING INFORMATION**

Orderable Device	Status (1)	Package Type	Package Drawing	Pins	Package Qty	Eco Plan (2)	Lead/Ball Finish	MSL Peak Temp (3)	Op Temp (°C)	Top-Side Markings (4)	Samples
DS3695AM	ACTIVE	SOIC	D	8	95	TBD	Call TI	Call TI	0 to 70	DS36 95AM	<a href="#">Samples</a>
DS3695AM/NOPB	ACTIVE	SOIC	D	8	95	Green (RoHS & no Sb/Br)	CU SN	Level-1-260C-UNLIM	0 to 70	DS36 95AM	<a href="#">Samples</a>
DS3695AMX	ACTIVE	SOIC	D	8	2500	TBD	Call TI	Call TI	0 to 70	DS36 95AM	<a href="#">Samples</a>
DS3695AMX/NOPB	ACTIVE	SOIC	D	8	2500	Green (RoHS & no Sb/Br)	CU SN	Level-1-260C-UNLIM	0 to 70	DS36 95AM	<a href="#">Samples</a>
DS3695ATM	ACTIVE	SOIC	D	8	95	TBD	Call TI	Call TI	-40 to 85	DS369 5ATM	<a href="#">Samples</a>
DS3695ATM/NOPB	ACTIVE	SOIC	D	8	95	Green (RoHS & no Sb/Br)	CU SN	Level-1-260C-UNLIM	-40 to 85	DS369 5ATM	<a href="#">Samples</a>
DS3695ATMX	ACTIVE	SOIC	D	8	2500	TBD	Call TI	Call TI	-40 to 85	DS369 5ATM	<a href="#">Samples</a>
DS3695ATMX/NOPB	ACTIVE	SOIC	D	8	2500	Green (RoHS & no Sb/Br)	CU SN	Level-1-260C-UNLIM	-40 to 85	DS369 5ATM	<a href="#">Samples</a>

(1) The marketing status values are defined as follows:

**ACTIVE:** Product device recommended for new designs.

**LIFEBUY:** TI has announced that the device will be discontinued, and a lifetime-buy period is in effect.

**NRND:** Not recommended for new designs. Device is in production to support existing customers, but TI does not recommend using this part in a new design.

**PREVIEW:** Device has been announced but is not in production. Samples may or may not be available.

**OBSELETE:** TI has discontinued the production of the device.

(2) Eco Plan - The planned eco-friendly classification: Pb-Free (RoHS), Pb-Free (RoHS Exempt), or Green (RoHS & no Sb/Br) - please check <http://www.ti.com/productcontent> for the latest availability information and additional product content details.

**TBD:** The Pb-Free/Green conversion plan has not been defined.

**Pb-Free (RoHS):** TI's terms "Lead-Free" or "Pb-Free" mean semiconductor products that are compatible with the current RoHS requirements for all 6 substances, including the requirement that lead not exceed 0.1% by weight in homogeneous materials. Where designed to be soldered at high temperatures, TI Pb-Free products are suitable for use in specified lead-free processes.

**Pb-Free (RoHS Exempt):** This component has a RoHS exemption for either 1) lead-based flip-chip solder bumps used between the die and package, or 2) lead-based die adhesive used between the die and leadframe. The component is otherwise considered Pb-Free (RoHS compatible) as defined above.

**Green (RoHS & no Sb/Br):** TI defines "Green" to mean Pb-Free (RoHS compatible), and free of Bromine (Br) and Antimony (Sb) based flame retardants (Br or Sb do not exceed 0.1% by weight in homogeneous material)

(3) MSL, Peak Temp. -- The Moisture Sensitivity Level rating according to the JEDEC industry standard classifications, and peak solder temperature.



<sup>(4)</sup> Multiple Top-Side Markings will be inside parentheses. Only one Top-Side Marking contained in parentheses and separated by a "~" will appear on a device. If a line is indented then it is a continuation of the previous line and the two combined represent the entire Top-Side Marking for that device.

**Important Information and Disclaimer:**The information provided on this page represents TI's knowledge and belief as of the date that it is provided. TI bases its knowledge and belief on information provided by third parties, and makes no representation or warranty as to the accuracy of such information. Efforts are underway to better integrate information from third parties. TI has taken and continues to take reasonable steps to provide representative and accurate information but may not have conducted destructive testing or chemical analysis on incoming materials and chemicals. TI and TI suppliers consider certain information to be proprietary, and thus CAS numbers and other limited information may not be available for release.

In no event shall TI's liability arising out of such information exceed the total purchase price of the TI part(s) at issue in this document sold by TI to Customer on an annual basis.

**TAPE AND REEL INFORMATION**

**QUADRANT ASSIGNMENTS FOR PIN 1 ORIENTATION IN TAPE**

\*All dimensions are nominal

Device	Package Type	Package Drawing	Pins	SPQ	Reel Diameter (mm)	Reel Width W1 (mm)	A0 (mm)	B0 (mm)	K0 (mm)	P1 (mm)	W (mm)	Pin1 Quadrant
DS3695AMX	SOIC	D	8	2500	330.0	12.4	6.5	5.4	2.0	8.0	12.0	Q1
DS3695AMX/NOPB	SOIC	D	8	2500	330.0	12.4	6.5	5.4	2.0	8.0	12.0	Q1
DS3695ATMX	SOIC	D	8	2500	330.0	12.4	6.5	5.4	2.0	8.0	12.0	Q1
DS3695ATMX/NOPB	SOIC	D	8	2500	330.0	12.4	6.5	5.4	2.0	8.0	12.0	Q1

**TAPE AND REEL BOX DIMENSIONS**

\*All dimensions are nominal

Device	Package Type	Package Drawing	Pins	SPQ	Length (mm)	Width (mm)	Height (mm)
DS3695AMX	SOIC	D	8	2500	349.0	337.0	45.0
DS3695AMX/NOPB	SOIC	D	8	2500	349.0	337.0	45.0
DS3695ATMX	SOIC	D	8	2500	349.0	337.0	45.0
DS3695ATMX/NOPB	SOIC	D	8	2500	349.0	337.0	45.0

D (R-PDSO-G8)

PLASTIC SMALL OUTLINE



- NOTES:
- A. All linear dimensions are in inches (millimeters).
  - B. This drawing is subject to change without notice.
  - Body length does not include mold flash, protrusions, or gate burrs. Mold flash, protrusions, or gate burrs shall not exceed 0.006 (0,15) each side.
  - Body width does not include interlead flash. Interlead flash shall not exceed 0.017 (0,43) each side.
  - E. Reference JEDEC MS-012 variation AA.

## IMPORTANT NOTICE

Texas Instruments Incorporated and its subsidiaries (TI) reserve the right to make corrections, enhancements, improvements and other changes to its semiconductor products and services per JESD46, latest issue, and to discontinue any product or service per JESD48, latest issue. Buyers should obtain the latest relevant information before placing orders and should verify that such information is current and complete. All semiconductor products (also referred to herein as "components") are sold subject to TI's terms and conditions of sale supplied at the time of order acknowledgment.

TI warrants performance of its components to the specifications applicable at the time of sale, in accordance with the warranty in TI's terms and conditions of sale of semiconductor products. Testing and other quality control techniques are used to the extent TI deems necessary to support this warranty. Except where mandated by applicable law, testing of all parameters of each component is not necessarily performed.

TI assumes no liability for applications assistance or the design of Buyers' products. Buyers are responsible for their products and applications using TI components. To minimize the risks associated with Buyers' products and applications, Buyers should provide adequate design and operating safeguards.

TI does not warrant or represent that any license, either express or implied, is granted under any patent right, copyright, mask work right, or other intellectual property right relating to any combination, machine, or process in which TI components or services are used. Information published by TI regarding third-party products or services does not constitute a license to use such products or services or a warranty or endorsement thereof. Use of such information may require a license from a third party under the patents or other intellectual property of the third party, or a license from TI under the patents or other intellectual property of TI.

Reproduction of significant portions of TI information in TI data books or data sheets is permissible only if reproduction is without alteration and is accompanied by all associated warranties, conditions, limitations, and notices. TI is not responsible or liable for such altered documentation. Information of third parties may be subject to additional restrictions.

Resale of TI components or services with statements different from or beyond the parameters stated by TI for that component or service voids all express and any implied warranties for the associated TI component or service and is an unfair and deceptive business practice. TI is not responsible or liable for any such statements.

Buyer acknowledges and agrees that it is solely responsible for compliance with all legal, regulatory and safety-related requirements concerning its products, and any use of TI components in its applications, notwithstanding any applications-related information or support that may be provided by TI. Buyer represents and agrees that it has all the necessary expertise to create and implement safeguards which anticipate dangerous consequences of failures, monitor failures and their consequences, lessen the likelihood of failures that might cause harm and take appropriate remedial actions. Buyer will fully indemnify TI and its representatives against any damages arising out of the use of any TI components in safety-critical applications.

In some cases, TI components may be promoted specifically to facilitate safety-related applications. With such components, TI's goal is to help enable customers to design and create their own end-product solutions that meet applicable functional safety standards and requirements. Nonetheless, such components are subject to these terms.

No TI components are authorized for use in FDA Class III (or similar life-critical medical equipment) unless authorized officers of the parties have executed a special agreement specifically governing such use.

Only those TI components which TI has specifically designated as military grade or "enhanced plastic" are designed and intended for use in military/aerospace applications or environments. Buyer acknowledges and agrees that any military or aerospace use of TI components which have **not** been so designated is solely at the Buyer's risk, and that Buyer is solely responsible for compliance with all legal and regulatory requirements in connection with such use.

TI has specifically designated certain components as meeting ISO/TS16949 requirements, mainly for automotive use. In any case of use of non-designated products, TI will not be responsible for any failure to meet ISO/TS16949.

### Products

Audio	<a href="http://www.ti.com/audio">www.ti.com/audio</a>
Amplifiers	<a href="http://amplifier.ti.com">amplifier.ti.com</a>
Data Converters	<a href="http://dataconverter.ti.com">dataconverter.ti.com</a>
DLP® Products	<a href="http://www.dlp.com">www.dlp.com</a>
DSP	<a href="http://dsp.ti.com">dsp.ti.com</a>
Clocks and Timers	<a href="http://www.ti.com/clocks">www.ti.com/clocks</a>
Interface	<a href="http://interface.ti.com">interface.ti.com</a>
Logic	<a href="http://logic.ti.com">logic.ti.com</a>
Power Mgmt	<a href="http://power.ti.com">power.ti.com</a>
Microcontrollers	<a href="http://microcontroller.ti.com">microcontroller.ti.com</a>
RFID	<a href="http://www.ti-rfid.com">www.ti-rfid.com</a>
OMAP Applications Processors	<a href="http://www.ti.com/omap">www.ti.com/omap</a>
Wireless Connectivity	<a href="http://www.ti.com/wirelessconnectivity">www.ti.com/wirelessconnectivity</a>

### Applications

Automotive and Transportation	<a href="http://www.ti.com/automotive">www.ti.com/automotive</a>
Communications and Telecom	<a href="http://www.ti.com/communications">www.ti.com/communications</a>
Computers and Peripherals	<a href="http://www.ti.com/computers">www.ti.com/computers</a>
Consumer Electronics	<a href="http://www.ti.com/consumer-apps">www.ti.com/consumer-apps</a>
Energy and Lighting	<a href="http://www.ti.com/energy">www.ti.com/energy</a>
Industrial	<a href="http://www.ti.com/industrial">www.ti.com/industrial</a>
Medical	<a href="http://www.ti.com/medical">www.ti.com/medical</a>
Security	<a href="http://www.ti.com/security">www.ti.com/security</a>
Space, Avionics and Defense	<a href="http://www.ti.com/space-avionics-defense">www.ti.com/space-avionics-defense</a>
Video and Imaging	<a href="http://www.ti.com/video">www.ti.com/video</a>

### TI E2E Community

[e2e.ti.com](http://e2e.ti.com)