

LM2940QML 1A Low Dropout Regulator

 Check for Samples: [LM2940QML](#), [LM2940QML-SP](#)

FEATURES

- Available with Radiation Ensure
 - ELDRS Free 100 krad(Si)
- Dropout Voltage Typically 0.5V @ $I_o = 1A$
- Output Current in Excess of 1A
- Output Voltage Trimmed Before Assembly
- Reverse Battery Protection
- Internal Short Circuit Current Limit
- Mirror Image Insertion Protection

DESCRIPTION

The LM2940 positive voltage regulator features the ability to source 1A of output current with a dropout voltage of typically 0.5V and a maximum of 1V over the entire temperature range. Furthermore, a quiescent current reduction circuit has been included which reduces the ground current when the differential between the input voltage and the output voltage exceeds approximately 3V. The quiescent current with 1A of output current and an input-output differential of 5V is therefore only 30 mA. Higher quiescent currents only exist when the regulator is in the dropout mode ($V_{IN} - V_{OUT} \leq 3V$).

Designed also for vehicular applications, the LM2940 and all regulated circuitry are protected from reverse battery installations or 2-battery jumps. During line transients, such as load dump when the input voltage can momentarily exceed the specified maximum operating voltage, the regulator will automatically shut down to protect both the internal circuits and the load. The LM2940 cannot be harmed by temporary mirror-image insertion. Familiar regulator features such as short circuit and thermal overload protection are also provided.

CONNECTION DIAGRAMS

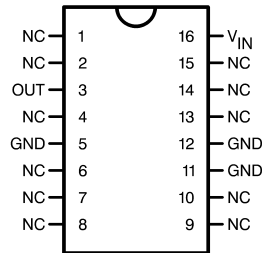

Figure 1. 16-Lead Ceramic Surface-Mount Package (CFP) Top View



Please be aware that an important notice concerning availability, standard warranty, and use in critical applications of Texas Instruments semiconductor products and disclaimers thereto appears at the end of this data sheet.

All trademarks are the property of their respective owners.

Equivalent Schematic Diagram

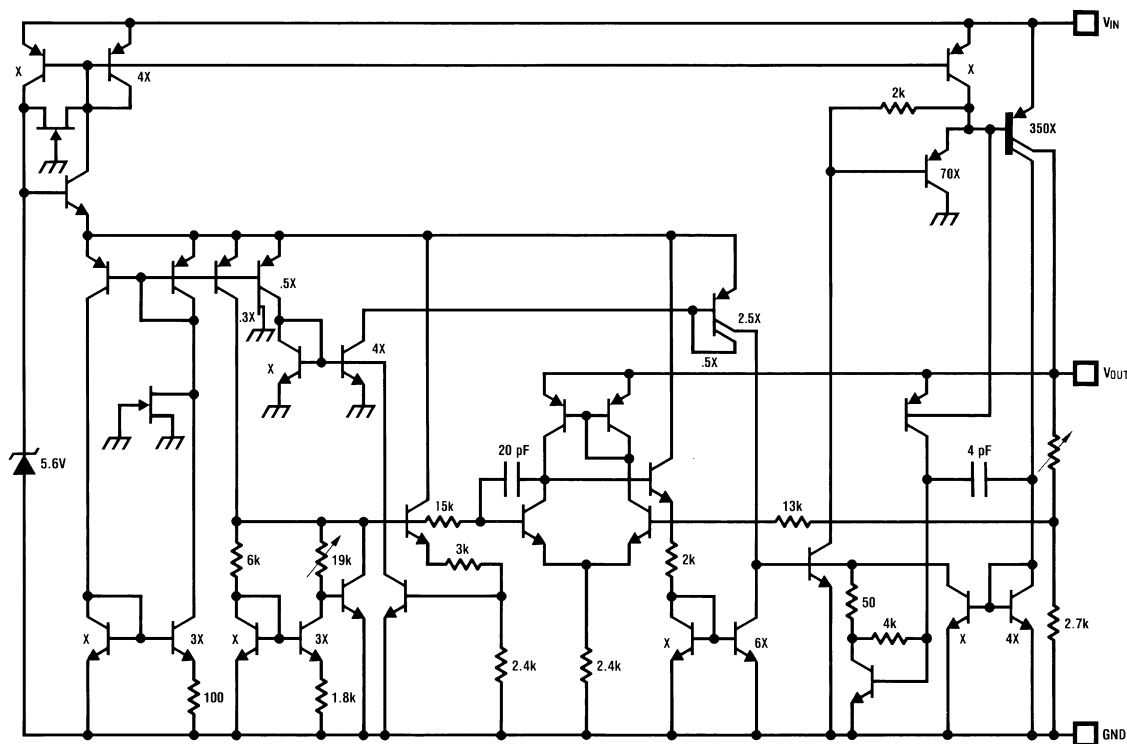

These devices have limited built-in ESD protection. The leads should be shorted together or the device placed in conductive foam during storage or handling to prevent electrostatic damage to the MOS gates.

Absolute Maximum Ratings⁽¹⁾

Input Voltage (Survival Voltage \leq 100mS)		60V	
Internal Power Dissipation with no heat sink ($T_A = +25^\circ\text{C}$) ⁽²⁾		1W	
Maximum Junction Temperature		150°C	
Storage Temperature Range		$-65^\circ\text{C} \leq T_A \leq +150^\circ\text{C}$	
Lead Temperature (Soldering 10 seconds)		300°C	
Thermal Resistance	θ_{JA}	16LD CFP "WG" (device 01, 02) (Still Air)	122°C/W
		16LD CFP "GW" (device 03, 04) (Still Air)	136°C/W
		16LD CFP "WG" (device 01, 02) (500LF/Min Air flow)	77°C/W
		16LD CFP "GW" (device 03, 04) (500LF/Min Air flow)	87°C/W
	θ_{JC}	16LD CFP "WG" (device 01, 02) ⁽³⁾	5°C/W
		16LD CFP "GW" (device 03, 04)	13°C/W
Package Weight CFP "WG" (device 01, 02)		360 mg	
Package Weight CFP "GW" (device 03, 04)		410 mg	
ESD Susceptibility ⁽⁴⁾		4KV	

- (1) Absolute Maximum Ratings indicate limits beyond which damage to the device may occur. Operating Ratings indicate conditions for which the device is functional, but do not ensure specific performance limits. For specified specifications and test conditions, see the Electrical Characteristics. The ensured specifications apply only for the test conditions listed. Some performance characteristics may degrade when the device is not operated under the listed test conditions.
- (2) The maximum power dissipation must be derated at elevated temperatures and is dictated by T_{Jmax} (maximum junction temperature), θ_{JA} (package junction to ambient thermal resistance), and T_A (ambient temperature). The maximum allowable power dissipation at any temperature is $P_{Dmax} = (T_{Jmax} - T_A)/\theta_{JA}$ or the number given in the Absolute Maximum Ratings, whichever is lower. With heat sinking, the maximum power is 5 Watts, but then this will depend upon the temperature of the heat sink, the efficiency of the heat sink, and the efficiency of the heat flow between the package body and the heat sink. We can not predict these values.
- (3) The package material for these devices allows much improved heat transfer over our standard ceramic packages. In order to take full advantage of this improved heat transfer, heat sinking must be provided between the package base (directly beneath the die), and either metal traces on, or thermal vias through, the printed circuit board. Without this additional heat sinking, device power dissipation must be calculated using θ_{JA} , rather than θ_{JC} , thermal resistance. It must not be assumed that the device leads will provide substantial heat transfer out of the package, since the thermal resistance of the lead frame material is very poor, relative to the material of the package base. The stated θ_{JC} thermal resistance is for the package material only, and does not account for the additional thermal resistance between the package base and the printed circuit board. The user must determine the value of the additional thermal resistance and must combine this with the stated value for the package, to calculate the total allowed power dissipation for the device.
- (4) Human body model, 1.5 k Ω in series with 100 pF.

Recommended Operating Conditions⁽¹⁾

Input Voltage	26V
Temperature Range	$-55^\circ\text{C} \leq T_A \leq 125^\circ\text{C}$

- (1) Absolute Maximum Ratings indicate limits beyond which damage to the device may occur. Operating Ratings indicate conditions for which the device is functional, but do not ensure specific performance limits. For specified specifications and test conditions, see the Electrical Characteristics. The ensured specifications apply only for the test conditions listed. Some performance characteristics may degrade when the device is not operated under the listed test conditions.

Table 1. Quality Conformance Inspection Mil-Std-883, Method 5005 - Group A

Subgroup	Description	Temp °C
1	Static tests at	+25
2	Static tests at	+125
3	Static tests at	-55
4	Dynamic tests at	+25
5	Dynamic tests at	+125
6	Dynamic tests at	-55
7	Functional tests at	+25
8A	Functional tests at	+125
8B	Functional tests at	-55
9	Switching tests at	+25
10	Switching tests at	+125
11	Switching tests at	-55
12	Settling time at	+25
13	Settling time at	+125
14	Settling time at	-55

LM2940-5.0 Electrical Characteristics SMD: 5962R8958701 DC Parameters

The following conditions apply, unless otherwise specified.

DC: $V_I = 10V$, $I_O = 1A$, $C_O = 22\mu F$

Symbol	Parameter	Conditions	Notes	Min	Max	Unit	Sub-groups
V_O	Output Voltage	$V_{IN} = 10V, I_{OUT} = 5mA$		4.85	5.15	V	1
				4.75	5.25	V	2, 3
		$V_{IN} = 6V, I_{OUT} = 5mA$		4.85	5.15	V	1
				4.75	5.25	V	2, 3
		$V_{IN} = 7V, I_{OUT} = 5mA$		4.85	5.15	V	1
				4.75	5.25	V	2, 3
		$V_{IN} = 26V, I_{OUT} = 5mA$		4.85	5.15	V	1
				4.75	5.25	V	2, 3
		$V_{IN} = 10V, I_{OUT} = 1A$		4.85	5.15	V	1
				4.75	5.25	V	2, 3
		$V_{IN} = 6V, I_{OUT} = 1A$		4.85	5.15	V	1
				4.75	5.25	V	2, 3
		$V_{IN} = 6V, I_{OUT} = 50mA$		4.85	5.15	V	1
				4.75	5.25	V	2, 3
$V_{IN} = 10V, I_{OUT} = 50mA$		4.85	5.15	V	1		
		4.75	5.25	V	2, 3		
	Reverse Polarity Input Voltage DC	$R_O = 100\Omega$	See ⁽¹⁾	-15		V	1, 2, 3
I_Q	Quiescent Current	$V_{IN} = 10V, I_{OUT} = 5mA$		0.0	15	mA	1
				0.0	20	mA	2, 3
		$V_{IN} = 7V, I_{OUT} = 5mA$		0.0	15	mA	1
				0.0	20	mA	2, 3
		$V_{IN} = 26V, I_{OUT} = 5mA$		0.0	15	mA	1
				0.0	20	mA	2, 3
		$V_{IN} = 10V, I_{OUT} = 1A$		0.0	50	mA	1
				0.0	100	mA	2, 3

(1) Functional test only.

LM2940-5.0 Electrical Characteristics SMD: 5962R8958701 DC Parameters (continued)

The following conditions apply, unless otherwise specified.

 DC: $V_I = 10V$, $I_O = 1A$, $C_O = 22\mu F$

Symbol	Parameter	Conditions	Notes	Min	Max	Unit	Sub-groups
V_{RLine}	Line Regulation	$7V \leq V_{IN} \leq 26V$, $I_{OUT} = 5mA$		-40	40	mV	1
				-50	50	mV	2, 3
V_{RLoad}	Load Regulation	$V_{IN} = 10V$, $50mA \leq I_{OUT} \leq 1A$		-50	50	mV	1
				-100	100	mV	2, 3
V_{DO}	Dropout Voltage	$I_{OUT} = 1A$		0.0	0.7	V	1
				0.0	1.0	V	2, 3
		$I_{OUT} = 100mA$		0.0	200	mV	1
				0.0	300	mV	2, 3
I_{sc}	Short Circuit Current	$V_{IN} = 10V$		1.5		A	1
				1.3		A	2, 3

LM2940-5.0 Electrical Characteristics SMD: 5962R8958701 AC Parameters

The following conditions apply, unless otherwise specified.

 AC: $V_I = 10V$, $I_O = 1A$, $C_O = 22\mu F$

Symbol	Parameter	Conditions	Notes	Min	Max	Unit	Sub-groups
	Max Line Transient	$V_O \leq 6V$, $R_O = 100\Omega$, $t = 20mS$	See ⁽¹⁾	40		V	1, 2, 3
	Reverse Polarity Input Voltage Transient	$t = 20mS$, $R_O = 100\Omega$	See ⁽¹⁾	-45		V	1, 2, 3
RR	Ripple Rejection	$V_{IN} = 10V$, $1V_{RMS}$, $f = 1KHz$, $I_{OUT} = 5mA$		60		dB	4
				50		dB	5, 6
N_O	Output Noise Voltage	$V_{IN} = 10V$, $I_{OUT} = 5mA$, 10Hz - 100KHz	See ⁽¹⁾	0.0	700	μV_{RMS}	1, 2, 3
Z_O	Output Impedance	$V_{IN} = 10V$, $f_O = 120Hz$ $I_{OUT} = 100mA$ DC and 20mA AC	See ⁽¹⁾		1.0	Ω	1, 2, 3

(1) Functional test only.

LM2940-5.0 Electrical Characteristics SMD: 5962R8958702 DC Parameters

The following conditions apply, unless otherwise specified.

DC: $V_I = 10V$, $I_O = 1A$, $C_O = 22\mu F$

Symbol	Parameter	Conditions	Notes	Min	Max	Unit	Sub-groups		
V_O	Output Voltage	$V_{IN} = 10V, I_{OUT} = 5mA$		4.85	5.15	V	1		
				4.75	5.25	V	2, 3		
		$V_{IN} = 6V, I_{OUT} = 5mA$		4.85	5.15	V	1		
				4.75	5.25	V	2, 3		
		$V_{IN} = 7V, I_{OUT} = 5mA$		4.85	5.15	V	1		
				4.75	5.25	V	2, 3		
		$V_{IN} = 26V, I_{OUT} = 5mA$		4.85	5.15	V	1		
				4.75	5.25	V	2, 3		
		$V_{IN} = 10V, I_{OUT} = 1A$		4.85	5.15	V	1		
				4.75	5.25	V	2, 3		
		$V_{IN} = 6V, I_{OUT} = 1A$		4.85	5.15	V	1		
				4.75	5.25	V	2, 3		
		$V_{IN} = 6V, I_{OUT} = 50mA$		4.85	5.15	V	1		
				4.75	5.25	V	2, 3		
$V_{IN} = 10V, I_{OUT} = 50mA$		4.85	5.15	V	1				
		4.75	5.25	V	2, 3				
	Reverse Polarity Input Voltage DC	$R_O = 100\Omega$	See ⁽¹⁾	-15		V	1, 2, 3		
I_Q	Quiescent Current	$V_{IN} = 10V, I_{OUT} = 5mA$		0.0	15	mA	1		
				0.0	20	mA	2, 3		
		$V_{IN} = 7V, I_{OUT} = 5mA$		0.0	15	mA	1		
				0.0	20	mA	2, 3		
		$V_{IN} = 26V, I_{OUT} = 5mA$		0.0	15	mA	1		
				0.0	20	mA	2, 3		
		$V_{IN} = 10V, I_{OUT} = 1A$		0.0	50	mA	1		
				0.0	100	mA	2, 3		
		V_{RLine}	Line Regulation	$7V \leq V_{IN} \leq 26V, I_{OUT} = 5mA$		-40	40	mV	1
						-50	50	mV	2, 3
V_{RLoad}	Load Regulation	$V_{IN} = 10V, 50mA \leq I_{OUT} \leq 1A$		-50	50	mV	1		
				-100	100	mV	2, 3		
V_{DO}	Dropout Voltage	$I_{OUT} = 1A$		0.0	0.7	V	1		
				0.0	1.0	V	2, 3		
		$I_{OUT} = 100mA$		0.0	200	mV	1		
				0.0	300	mV	2, 3		
I_{sc}	Short Circuit Current	$V_{IN} = 10V$		1.5		A	1		
				1.3		A	2, 3		

(1) Functional test only.

LM2940-5.0 Electrical Characteristics SMD: 5962R8958702 AC Parameters

The following conditions apply, unless otherwise specified.

 AC: $V_I = 10V$, $I_O = 1A$, $C_O = 22\mu F$

Symbol	Parameter	Conditions	Notes	Min	Max	Unit	Sub-groups
	Max Line Transient	$V_O \leq 6V$, $R_O = 100\Omega$, $t = 20mS$	See ⁽¹⁾	40		V	1, 2, 3
	Reverse Polarity Input Voltage Transient	$t = 20mS$, $R_O = 100\Omega$	See ⁽¹⁾	-45		V	1, 2, 3
RR	Ripple Rejection	$V_{IN} = 10V$, $1V_{RMS}$, $f = 1KHz$, $I_{OUT} = 5mA$	See ⁽¹⁾	60		dB	4
			See ⁽¹⁾	50		dB	5, 6
N_O	Output Noise Voltage	$V_{IN} = 10V$, $I_{OUT} = 5mA$, 10Hz - 100KHz	See ⁽¹⁾	0.0	700	μV_{RMS}	1, 2, 3
Z_O	Output Impedance	$V_{IN} = 10V$, $f_O = 120Hz$ $I_{OUT} = 100mA$ DC and 20mA AC	See ⁽¹⁾		1.0	Ω	1, 2, 3

(1) Functional test only.

LM2940-5.0 Electrical Characteristics SMD: 5962R8958702 DC Drift Parameters

The following conditions apply, unless otherwise specified.

 DC: $V_I = 10V$, $I_O = 1A$, $C_O = 22\mu F$, “Delta calculations performed on QMLV devices at group B, subgroup 5 only”

Symbol	Parameter	Conditions	Notes	Min	Max	Unit	Sub-groups
V_O	Output Voltage	$V_{IN} = 10V$, $I_{OUT} = 5mA$		-30	30	mV	1
		$V_{IN} = 6V$, $I_{OUT} = 5mA$		-30	30	mV	1
		$V_{IN} = 7V$, $I_{OUT} = 5mA$		-30	30	mV	1
		$V_{IN} = 26V$, $I_{OUT} = 5mA$		-30	30	mV	1
		$V_{IN} = 10V$, $I_{OUT} = 1A$		-30	30	mV	1
		$V_{IN} = 6V$, $I_{OUT} = 1A$		-30	30	mV	1
		$V_{IN} = 6V$, $I_{OUT} = 50mA$		-30	30	mV	1
		$V_{IN} = 10V$, $I_{OUT} = 50mA$		-30	30	mV	1
V_{RLOAD}	Load Regulation	$V_{IN} = 10V$, $50mA \leq I_{OUT} \leq 1A$		-20	20	mV	1

Typical Performance Characteristics

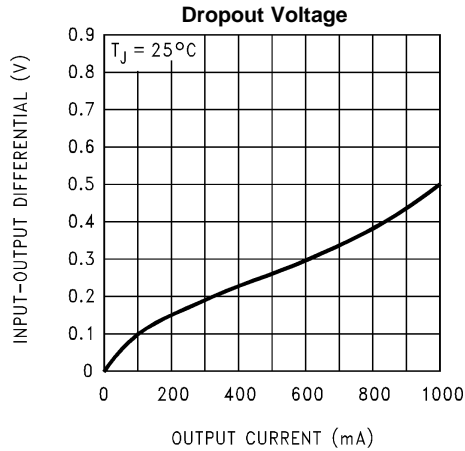

Figure 2.

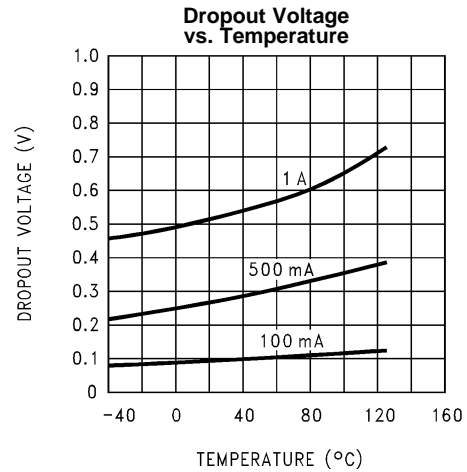

Figure 3.

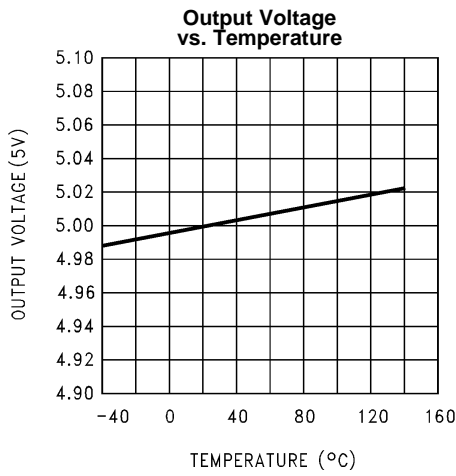

Figure 4.

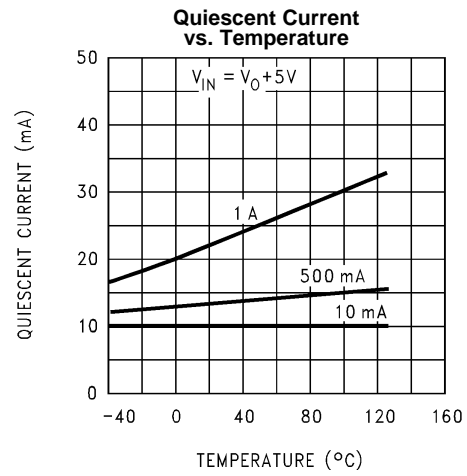

Figure 5.

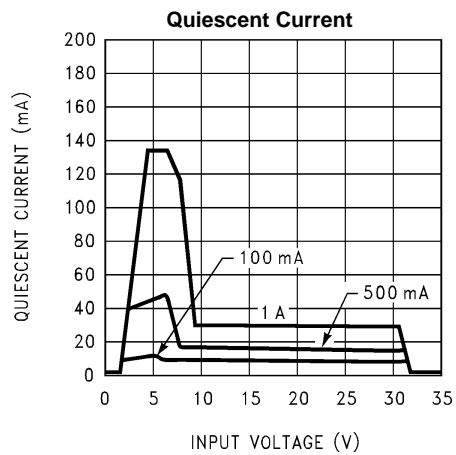

Figure 6.

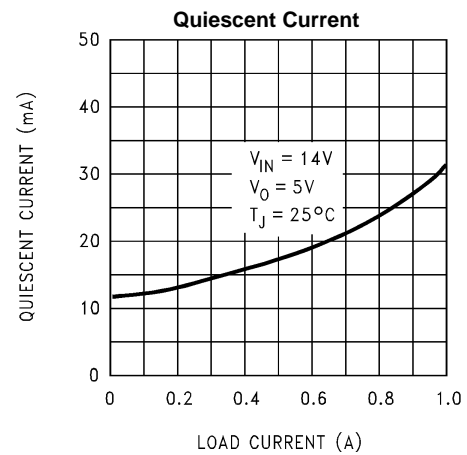

Figure 7.

Typical Performance Characteristics (continued)

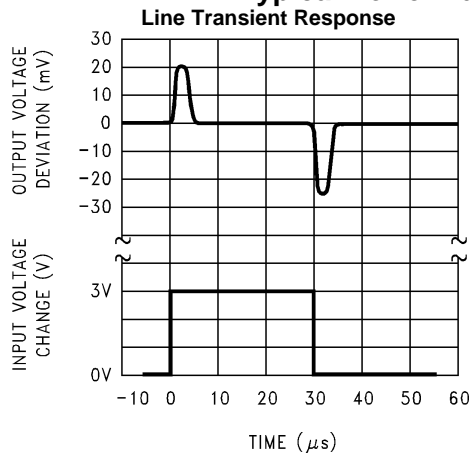

Figure 8.

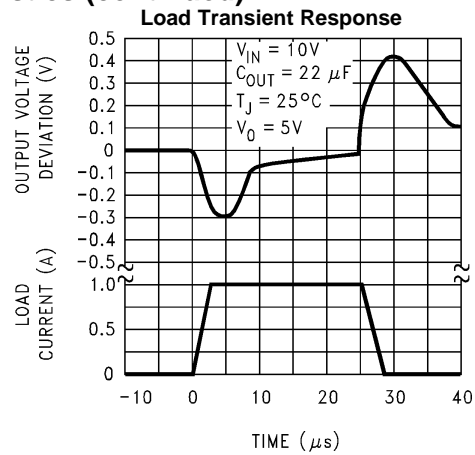

Figure 9.

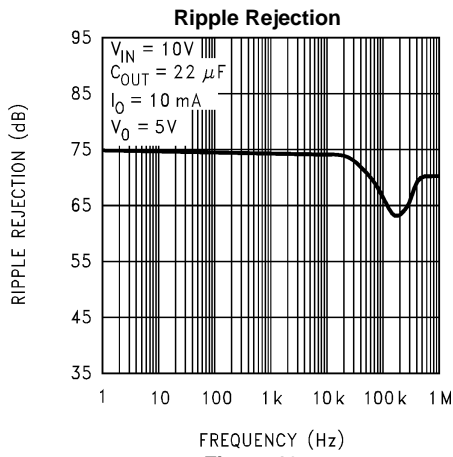

Figure 10.

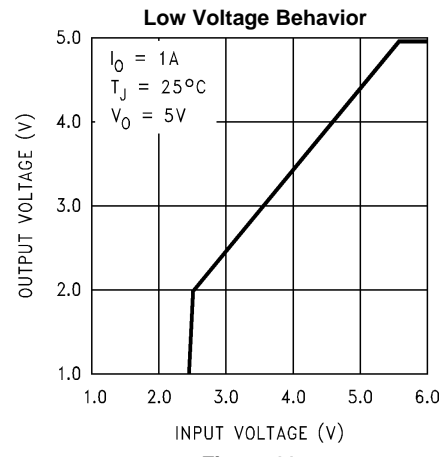

Figure 11.

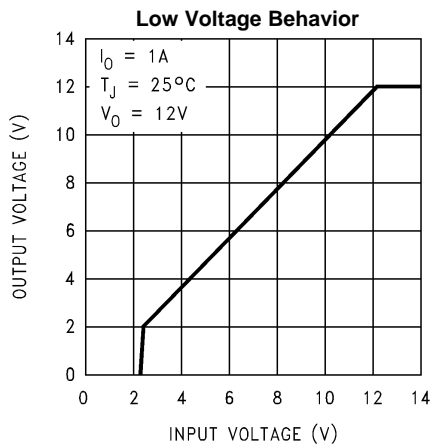

Figure 12.

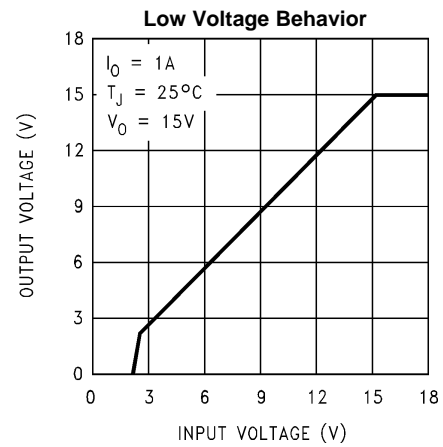

Figure 13.

Typical Performance Characteristics (continued)

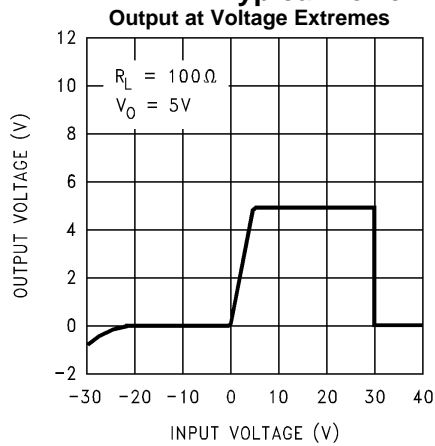

Figure 14.

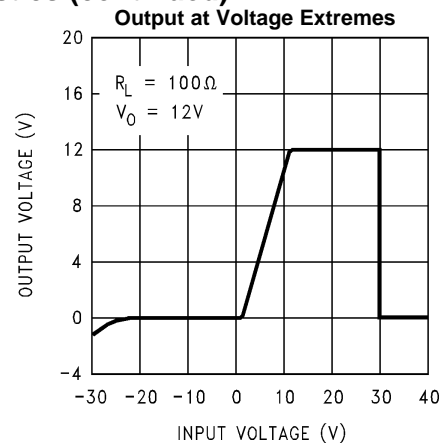

Figure 15.

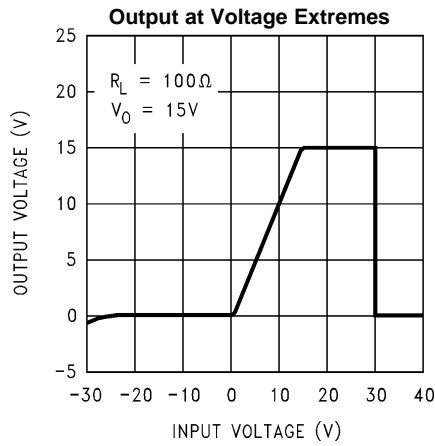

Figure 16.

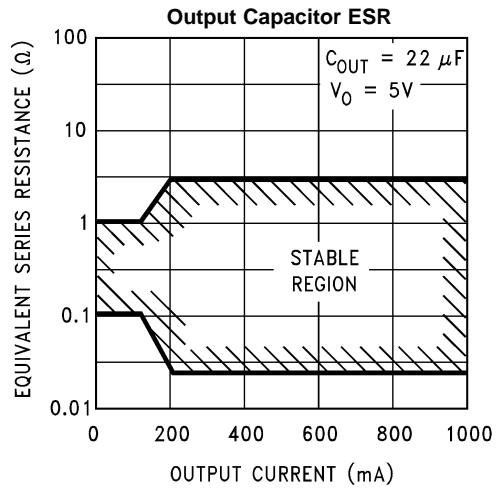

Figure 17.

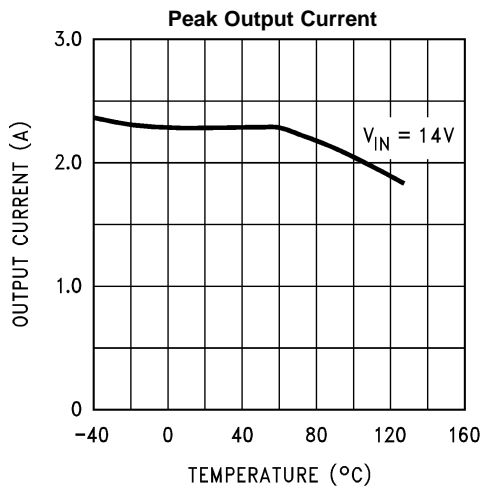

Figure 18.

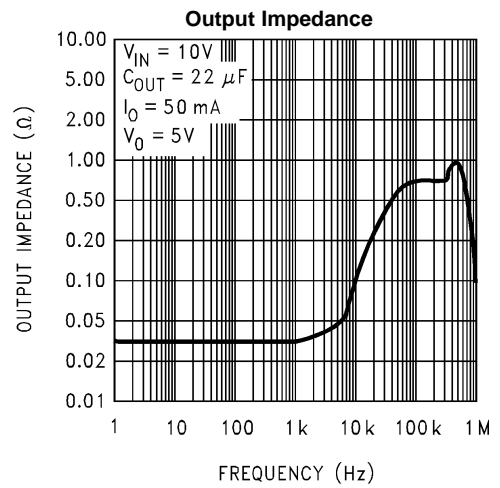
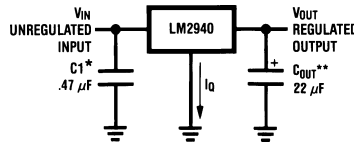

Figure 19.

Typical Application



*Required if regulator is located far from power supply filter.

** C_{OUT} must be at least 22 μF to maintain stability. May be increased without bound to maintain regulation during transients. Locate as close as possible to the regulator. This capacitor must be rated over the same operating temperature range as the regulator and the ESR is critical; see curve.

APPLICATION HINTS

EXTERNAL CAPACITORS

The output capacitor is critical to maintaining regulator stability, and must meet the required conditions for both ESR (Equivalent Series Resistance) and minimum amount of capacitance.

MINIMUM CAPACITANCE:

The minimum output capacitance required to maintain stability is 22 μF (this value may be increased without limit). Larger values of output capacitance will give improved transient response.

ESR LIMITS:

The ESR of the output capacitor will cause loop instability if it is too high or too low. The acceptable range of ESR plotted versus load current is shown in the graph below. ***It is essential that the output capacitor meet these requirements, or oscillations can result.***

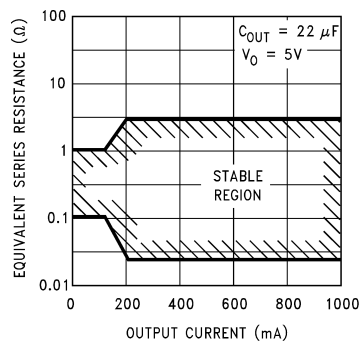

Figure 20. Output Capacitor ESR Limits

It is important to note that for most capacitors, ESR is specified only at room temperature. However, the designer must ensure that the ESR will stay inside the limits shown over the entire operating temperature range for the design.

For aluminum electrolytic capacitors, ESR will increase by about 30X as the temperature is reduced from 25°C to -40°C. This type of capacitor is not well-suited for low temperature operation.

Solid tantalum capacitors have a more stable ESR over temperature, but are more expensive than aluminum electrolytics. A cost-effective approach sometimes used is to parallel an aluminum electrolytic with a solid Tantalum, with the total capacitance split about 75/25% with the Aluminum being the larger value.

If two capacitors are paralleled, the effective ESR is the parallel of the two individual values. The “flatter” ESR of the Tantalum will keep the effective ESR from rising as quickly at low temperatures.

HEATSINKING

A heatsink may be required depending on the maximum power dissipation and maximum ambient temperature of the application. Under all possible operating conditions, the junction temperature must be within the range specified under [Absolute Maximum Ratings](#).

To determine if a heatsink is required, the power dissipated by the regulator, P_D , must be calculated.

The figure below shows the voltages and currents which are present in the circuit, as well as the formula for calculating the power dissipated in the regulator:

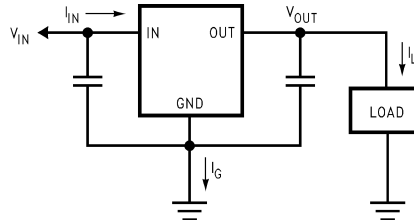

$$I_{IN} = I_L + I_G$$

$$P_D = (V_{IN} - V_{OUT}) I_L + (V_{IN}) I_G$$

Figure 21. Power Dissipation Diagram

The next parameter which must be calculated is the maximum allowable temperature rise, T_R (max). This is calculated by using the formula:

$$T_R \text{ (max)} = T_J \text{ (max)} - T_A \text{ (max)}$$

where

- T_J (max) is the maximum allowable junction temperature
- T_A (max) is the maximum ambient temperature which will be encountered in the application (1)

Using the calculated values for T_R (max) and P_D , the maximum allowable value for the junction-to-ambient thermal resistance, $\theta_{(JA)}$, can now be found:

$$\theta_{(JA)} = T_R \text{ (max)} / P_D \tag{2}$$

REVISION HISTORY

Released	Revision	Section	Changes
05/10/2010	A	New Release, Corporate format	1 MDS data sheets converted into one Corp. data sheet format added reference to New ELDRS device. Change AC subgroups from 4, 5, 6, 7, 8A, 8B to 1, 2, 3 for parameters Max Line Transient, Reverse Polarity Input Voltage Transient, Output Noise Voltage, Output Impedance. To bring it into agreement with the SMD. MNLM2940-5.0-X Rev 1A1 will be archived.
12/10/2010	B	Ordering Information, Absolute Max Ratings	Ordering Information — Added LM2940GW5.0/883, LM2940GW5.0RLQV. Absolute Max Ratings — Added Theta JA and Theta JC along with Package Weight for 'GW' devices. LM2940QML Rev A will be archived.
02/5/2013	B	All	layout of National Data Sheet to TI format

PACKAGING INFORMATION

Orderable Device	Status (1)	Package Type	Package Drawing	Pins	Package Qty	Eco Plan (2)	Lead/Ball Finish	MSL Peak Temp (3)	Op Temp (°C)	Top-Side Markings (4)	Samples
5962-8958703XA	ACTIVE	CFP	NAC	16	42	TBD	Call TI	Call TI	-55 to 125	LM2940GW5.0 /883 Q 5962-89587 03XA ACO 03XA >T	Samples
5962R8958704VXA	ACTIVE	CFP	NAC	16	42	TBD	Call TI	Call TI	-55 to 125	LM2940GW5.0 RLQMLV Q 5962R89587 04VXA ACO 04VXA >T	Samples
LM2940GW5.0/883	ACTIVE	CFP	NAC	16	42	TBD	Call TI	Call TI	-55 to 125	LM2940GW5.0 /883 Q 5962-89587 03XA ACO 03XA >T	Samples
LM2940GW5.0RLQV	ACTIVE	CFP	NAC	16	42	TBD	Call TI	Call TI	-55 to 125	LM2940GW5.0 RLQMLV Q 5962R89587 04VXA ACO 04VXA >T	Samples

(1) The marketing status values are defined as follows:

ACTIVE: Product device recommended for new designs.

LIFEBUY: TI has announced that the device will be discontinued, and a lifetime-buy period is in effect.

NRND: Not recommended for new designs. Device is in production to support existing customers, but TI does not recommend using this part in a new design.

PREVIEW: Device has been announced but is not in production. Samples may or may not be available.

OBSOLETE: TI has discontinued the production of the device.

(2) Eco Plan - The planned eco-friendly classification: Pb-Free (RoHS), Pb-Free (RoHS Exempt), or Green (RoHS & no Sb/Br) - please check <http://www.ti.com/productcontent> for the latest availability information and additional product content details.

TBD: The Pb-Free/Green conversion plan has not been defined.

Pb-Free (RoHS): TI's terms "Lead-Free" or "Pb-Free" mean semiconductor products that are compatible with the current RoHS requirements for all 6 substances, including the requirement that lead not exceed 0.1% by weight in homogeneous materials. Where designed to be soldered at high temperatures, TI Pb-Free products are suitable for use in specified lead-free processes.

Pb-Free (RoHS Exempt): This component has a RoHS exemption for either 1) lead-based flip-chip solder bumps used between the die and package, or 2) lead-based die adhesive used between the die and leadframe. The component is otherwise considered Pb-Free (RoHS compatible) as defined above.

Green (RoHS & no Sb/Br): TI defines "Green" to mean Pb-Free (RoHS compatible), and free of Bromine (Br) and Antimony (Sb) based flame retardants (Br or Sb do not exceed 0.1% by weight in homogeneous material)

⁽³⁾ MSL, Peak Temp. -- The Moisture Sensitivity Level rating according to the JEDEC industry standard classifications, and peak solder temperature.

⁽⁴⁾ Multiple Top-Side Markings will be inside parentheses. Only one Top-Side Marking contained in parentheses and separated by a "~" will appear on a device. If a line is indented then it is a continuation of the previous line and the two combined represent the entire Top-Side Marking for that device.

Important Information and Disclaimer:The information provided on this page represents TI's knowledge and belief as of the date that it is provided. TI bases its knowledge and belief on information provided by third parties, and makes no representation or warranty as to the accuracy of such information. Efforts are underway to better integrate information from third parties. TI has taken and continues to take reasonable steps to provide representative and accurate information but may not have conducted destructive testing or chemical analysis on incoming materials and chemicals. TI and TI suppliers consider certain information to be proprietary, and thus CAS numbers and other limited information may not be available for release.

In no event shall TI's liability arising out of such information exceed the total purchase price of the TI part(s) at issue in this document sold by TI to Customer on an annual basis.

OTHER QUALIFIED VERSIONS OF LM2940QML, LM2940QML-SP :

- Military: [LM2940QML](#)
- Space: [LM2940QML-SP](#)

NOTE: Qualified Version Definitions:

- Military - QML certified for Military and Defense Applications
- Space - Radiation tolerant, ceramic packaging and qualified for use in Space-based application

NAC0016A

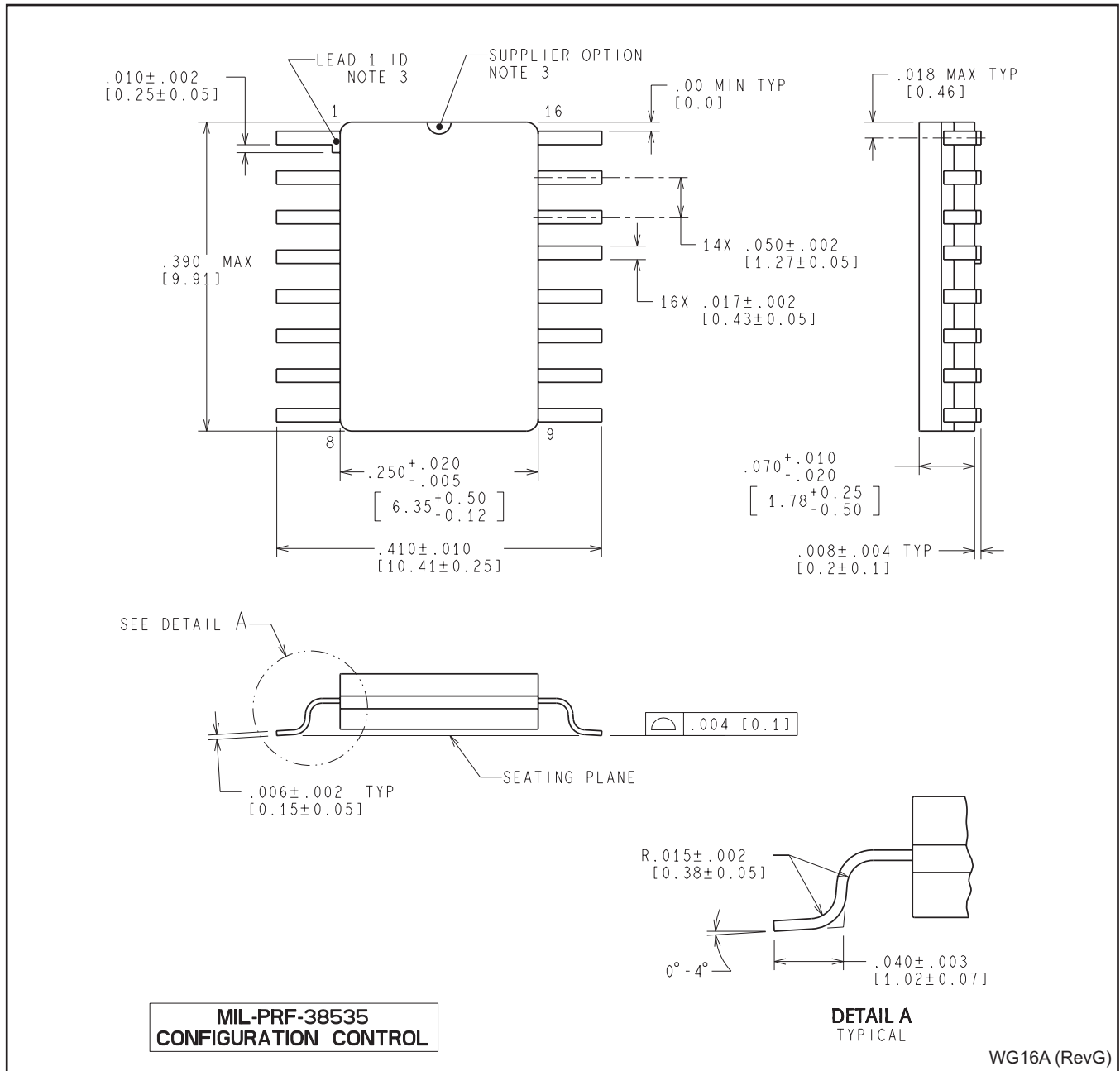

IMPORTANT NOTICE

Texas Instruments Incorporated and its subsidiaries (TI) reserve the right to make corrections, enhancements, improvements and other changes to its semiconductor products and services per JESD46, latest issue, and to discontinue any product or service per JESD48, latest issue. Buyers should obtain the latest relevant information before placing orders and should verify that such information is current and complete. All semiconductor products (also referred to herein as "components") are sold subject to TI's terms and conditions of sale supplied at the time of order acknowledgment.

TI warrants performance of its components to the specifications applicable at the time of sale, in accordance with the warranty in TI's terms and conditions of sale of semiconductor products. Testing and other quality control techniques are used to the extent TI deems necessary to support this warranty. Except where mandated by applicable law, testing of all parameters of each component is not necessarily performed.

TI assumes no liability for applications assistance or the design of Buyers' products. Buyers are responsible for their products and applications using TI components. To minimize the risks associated with Buyers' products and applications, Buyers should provide adequate design and operating safeguards.

TI does not warrant or represent that any license, either express or implied, is granted under any patent right, copyright, mask work right, or other intellectual property right relating to any combination, machine, or process in which TI components or services are used. Information published by TI regarding third-party products or services does not constitute a license to use such products or services or a warranty or endorsement thereof. Use of such information may require a license from a third party under the patents or other intellectual property of the third party, or a license from TI under the patents or other intellectual property of TI.

Reproduction of significant portions of TI information in TI data books or data sheets is permissible only if reproduction is without alteration and is accompanied by all associated warranties, conditions, limitations, and notices. TI is not responsible or liable for such altered documentation. Information of third parties may be subject to additional restrictions.

Resale of TI components or services with statements different from or beyond the parameters stated by TI for that component or service voids all express and any implied warranties for the associated TI component or service and is an unfair and deceptive business practice. TI is not responsible or liable for any such statements.

Buyer acknowledges and agrees that it is solely responsible for compliance with all legal, regulatory and safety-related requirements concerning its products, and any use of TI components in its applications, notwithstanding any applications-related information or support that may be provided by TI. Buyer represents and agrees that it has all the necessary expertise to create and implement safeguards which anticipate dangerous consequences of failures, monitor failures and their consequences, lessen the likelihood of failures that might cause harm and take appropriate remedial actions. Buyer will fully indemnify TI and its representatives against any damages arising out of the use of any TI components in safety-critical applications.

In some cases, TI components may be promoted specifically to facilitate safety-related applications. With such components, TI's goal is to help enable customers to design and create their own end-product solutions that meet applicable functional safety standards and requirements. Nonetheless, such components are subject to these terms.

No TI components are authorized for use in FDA Class III (or similar life-critical medical equipment) unless authorized officers of the parties have executed a special agreement specifically governing such use.

Only those TI components which TI has specifically designated as military grade or "enhanced plastic" are designed and intended for use in military/aerospace applications or environments. Buyer acknowledges and agrees that any military or aerospace use of TI components which have **not** been so designated is solely at the Buyer's risk, and that Buyer is solely responsible for compliance with all legal and regulatory requirements in connection with such use.

TI has specifically designated certain components as meeting ISO/TS16949 requirements, mainly for automotive use. In any case of use of non-designated products, TI will not be responsible for any failure to meet ISO/TS16949.

Products

Audio	www.ti.com/audio
Amplifiers	amplifier.ti.com
Data Converters	dataconverter.ti.com
DLP® Products	www.dlp.com
DSP	dsp.ti.com
Clocks and Timers	www.ti.com/clocks
Interface	interface.ti.com
Logic	logic.ti.com
Power Mgmt	power.ti.com
Microcontrollers	microcontroller.ti.com
RFID	www.ti-rfid.com
OMAP Applications Processors	www.ti.com/omap
Wireless Connectivity	www.ti.com/wirelessconnectivity

Applications

Automotive and Transportation	www.ti.com/automotive
Communications and Telecom	www.ti.com/communications
Computers and Peripherals	www.ti.com/computers
Consumer Electronics	www.ti.com/consumer-apps
Energy and Lighting	www.ti.com/energy
Industrial	www.ti.com/industrial
Medical	www.ti.com/medical
Security	www.ti.com/security
Space, Avionics and Defense	www.ti.com/space-avionics-defense
Video and Imaging	www.ti.com/video

TI E2E Community

e2e.ti.com