

LM6181 100 mA, 100 MHz Current Feedback Amplifier

Check for Samples: [LM6181](#)

FEATURES

- (Typical Unless Otherwise Noted)
- **Slew Rate: 2000 V/ μ s**
- **Settling Time (0.1%): 50 ns**
- **Characterized for Supply Ranges: ± 5 V and ± 15 V**
- **Low Differential Gain and Phase Error: 0.05%, 0.04°**
- **High Output Drive: ± 10 V into 100 Ω**
- **Ensured Bandwidth and Slew Rate**
- **Improved Performance Over EL2020, OP160, AD844, LT1223 and HA5004**

APPLICATIONS

- **Coax Cable Driver**
- **Video Amplifier**
- **Flash ADC Buffer**
- **High Frequency Filter**
- **Scanner and Imaging Systems**

Typical Application

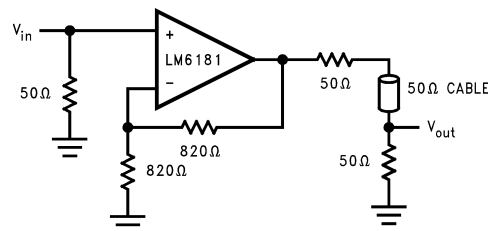
Figure 1. Cable Driver

DESCRIPTION

The LM6181 current-feedback amplifier offers an unparalleled combination of bandwidth, slew-rate, and output current. The amplifier can directly drive up to 100 pF capacitive loads without oscillating and a 10V signal into a 50 Ω or 75 Ω back-terminated coax cable system over the full industrial temperature range. This represents a radical enhancement in output drive capability for an 8-pin PDIP high-speed amplifier making it ideal for video applications.

Built on TI's advanced high-speed VIP™ II (Vertically Integrated PNP) process, the LM6181 employs current-feedback providing bandwidth that does not vary dramatically with gain; 100 MHz at $A_V = -1$, 60 MHz at $A_V = -10$. With a slew rate of 2000V/ μ s, 2nd harmonic distortion of -50 dBc at 10 MHz and settling time of 50 ns (0.1%) the LM6181 dynamic performance makes it ideal for data acquisition, high speed ATE, and precision pulse amplifier applications.



Please be aware that an important notice concerning availability, standard warranty, and use in critical applications of Texas Instruments semiconductor products and disclaimers thereto appears at the end of this data sheet.

VIP is a trademark of Texas Instruments.

All other trademarks are the property of their respective owners.

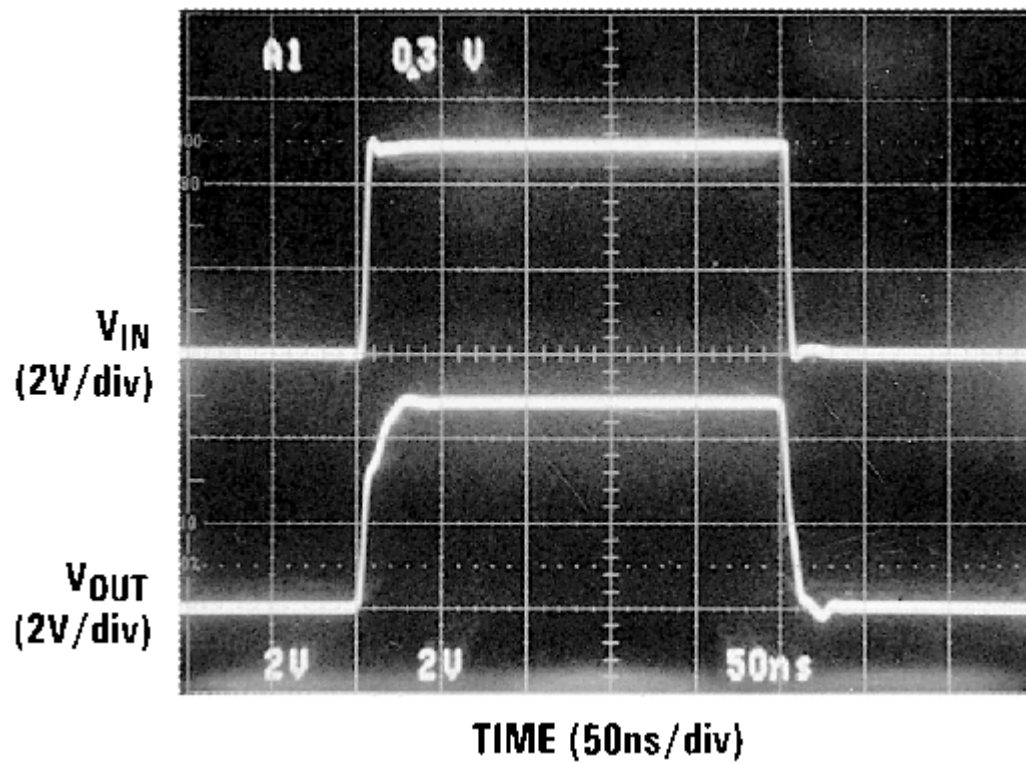

These devices have limited built-in ESD protection. The leads should be shorted together or the device placed in conductive foam during storage or handling to prevent electrostatic damage to the MOS gates.

Absolute Maximum Ratings⁽¹⁾⁽²⁾

Supply Voltage		±18V	
Differential Input Voltage		±6V	
Input Voltage		±Supply Voltage	
Inverting Input Current		15 mA	
Soldering Information	PDIP Package (N)	Soldering (10 sec)	260°C
	SOIC Package (M)	Vapor Phase (60 seconds)	215°C
		Infrared (15 seconds)	220°C
Output Short Circuit		See ⁽³⁾	
Storage Temperature Range		-65°C ≤ T _J ≤ +150°C	
Maximum Junction Temperature		150°C	
ESD Rating ⁽⁴⁾		±3000V	

- (1) Absolute Maximum Ratings indicate limits beyond which damage to the device may occur. Operating ratings indicate conditions the device is intended to be functional, but device parameter specifications may not be ensured under these conditions. For ensured specifications and test conditions, see the Electrical Characteristics.
- (2) If Military/Aerospace specified devices are required, please contact the Texas Instruments Sales Office/ Distributors for availability and specifications.
- (3) Continuous short circuit operation at elevated ambient temperature can result in exceeding the maximum allowed junction temperature of 150°C. Output currents in excess of ±130 mA over a long term basis may adversely affect reliability.
- (4) Human body model 100 pF and 1.5 kΩ.

Operating Ratings⁽¹⁾

Supply Voltage Range		7V to 32V
Junction Temperature Range ⁽²⁾	LM6181AM	-55°C ≤ T _J ≤ +125°C
	LM6181AI, LM6181I	-40°C ≤ T _J ≤ +85°C
Thermal Resistance (θ _{JA} , θ _{JC})	8-pin PDIP (N)	102°C/W, 42°C/W
	8-pin SOIC (M-8)	153°C/W, 42°C/W
	16-pin SOIC (M)	70°C/W, 38°C/W

- (1) For ensured Military Temperature Range parameters see RETS6181X.
- (2) The typical junction-to-ambient thermal resistance of the molded PDIP(N) package soldered directly into a PC board is 102°C/W. The junction-to-ambient thermal resistance of the SOIC (M) package mounted flush to the PC board is 70°C/W when pins 1, 4, 8, 9 and 16 are soldered to a total 2 in² 1 oz. copper trace. The 16-pin SOIC (M) package must have pin 4 and at least one of pins 1, 8, 9, or 16 connected to V₋ for proper operation. The typical junction-to-ambient thermal resistance of the SOIC (M-8) package soldered directly into a PC board is 153°C/W.

±15V DC Electrical Characteristics

The following specifications apply for Supply Voltage = ±15V, $R_F = 820\Omega$, and $R_L = 1\text{ k}\Omega$ unless otherwise noted. **Boldface** limits apply at the temperature extremes; all other limits $T_J = 25^\circ\text{C}$.

Symbol	Parameter	Conditions	LM6181AM		LM6181AI		LM6181I		Units
			Typical ⁽¹⁾	Limit ⁽²⁾	Typical ⁽¹⁾	Limit ⁽²⁾	Typical ⁽¹⁾	Limit ⁽²⁾	
V_{OS}	Input Offset Voltage		2.0	3.0 4.0	2.0	3.0 3.5	3.5	5.0 5.5	mV max
$TC\ V_{OS}$	Input Offset Voltage Drift		5.0		5.0		5.0		$\mu\text{V}/^\circ\text{C}$
I_B	Inverting Input Bias Current		2.0	5.0 12.0	2.0	5.0 12.0	5.0	10 17.0	μA max
	Non-Inverting Input Bias Current		0.5	1.5 3.0	0.5	1.5 3.0	2.0	3.0 5.0	
$TC\ I_B$	Inverting Input Bias Current Drift		30		30		30		$\text{nA}/^\circ\text{C}$
	Non-Inverting Input Bias Current Drift		10		10		10		
I_B PSR	Inverting Input Bias Current Power Supply Rejection	$V_S = \pm 4.5\text{V}, \pm 16\text{V}$	0.3	0.5 3.0	0.3	0.5 3.0	0.3	0.75 4.5	$\mu\text{A}/\text{V}$ max
	Non-Inverting Input Bias Current Power Supply Rejection	$V_S = \pm 4.5\text{V}, \pm 16\text{V}$	0.05	0.5 1.5	0.05	0.5 1.5	0.05	0.5 3.0	
I_B CMR	Inverting Input Bias Current Common Mode Rejection	$-10\text{V} \leq V_{CM} \leq +10\text{V}$	0.3	0.5 0.75	0.3	0.5 0.75	0.3	0.75 1.0	
	Non-Inverting Input Bias Current Common Mode Rejection	$-10\text{V} \leq V_{CM} \leq +10\text{V}$	0.1	0.5 0.5	0.1	0.5 0.5	0.1	0.5 0.5	
CMRR	Common Mode Rejection Ratio	$-10\text{V} \leq V_{CM} \leq +10\text{V}$	60	50 50	60	50 50	60	50 50	dB min
PSRR	Power Supply Rejection Ratio	$V_S = \pm 4.5\text{V}, \pm 16\text{V}$	80	70 70	80	70 70	80	70 65	dB min
R_O	Output Resistance	$A_V = -1, f = 300\text{ kHz}$	0.2		0.2		0.2		Ω
R_{IN}	Non-Inverting Input Resistance		10		10		10		$\text{M}\Omega$ min
V_O	Output Voltage Swing	$R_L = 1\text{ k}\Omega$	12	11 11	12	11 11	12	11 11	V min
		$R_L = 100\Omega$	11	10 7.5	11	10 8.0	11	10 8.0	
I_{SC}	Output Short Circuit Current		130	100 75	130	100 85	130	100 85	mA min
Z_T	Transimpedance	$R_L = 1\text{ k}\Omega$	1.8	1.0 0.5	1.8	1.0 0.5	1.8	0.8 0.4	$\text{M}\Omega$ min
		$R_L = 100\Omega$	1.4	0.8 0.4	1.4	0.8 0.4	1.4	0.7 0.35	
I_S	Supply Current	No Load, $V_O = 0\text{V}$	7.5	10 10	7.5	10 10	7.5	10 10	mA max
V_{CM}	Input Common Mode Voltage Range		$V^+ - 1.7\text{V}$ $V^- + 1.7\text{V}$		$V^+ - 1.7\text{V}$ $V^- + 1.7\text{V}$		$V^+ - 1.7\text{V}$ $V^- + 1.7\text{V}$		V

(1) Typical values represent the most likely parametric norm.

(2) All limits ensured at room temperature (standard type face) or at operating temperature extremes (**bold face type**).

±15V AC Electrical Characteristics

The following specifications apply for Supply Voltage = ±15V, $R_F = 820\Omega$, $R_L = 1\text{ k}\Omega$ unless otherwise noted. **Boldface** limits apply at the temperature extremes; all other limits $T_J = 25^\circ\text{C}$.

Symbol	Parameter	Conditions	LM6181AM		LM6181AI		LM6181I		Units
			Typical ⁽¹⁾	Limit ⁽²⁾	Typical ⁽¹⁾	Limit ⁽²⁾	Typical ⁽¹⁾	Limit ⁽²⁾	
BW	Closed Loop Bandwidth -3 dB	$A_V = +2$	100		100		100		MHz min
		$A_V = +10$	80		80		80		
		$A_V = -1$	100	80	100	80	100	80	
		$A_V = -10$	60		60		60		
PBW	Power Bandwidth	$A_V = -1$, $V_O = 5\text{ V}_{PP}$	60		60		60		
SR	Slew Rate	Overdriven	2000		2000		2000		V/ μs min
		$A_V = -1$, $V_O = \pm 10\text{V}$, $R_L = 150\Omega$ ⁽³⁾	1400	1000	1400	1000	1400	1000	
t_s	Settling Time (0.1%)	$A_V = -1$, $V_O = \pm 5\text{V}$ $R_L = 150\Omega$	50		50		50		ns
t_r , t_f	Rise and Fall Time	$V_O = 1\text{ V}_{PP}$	5		5		5		
t_p	Propagation Delay Time	$V_O = 1\text{ V}_{PP}$	6		6		6		
$i_{n(+)}$	Non-Inverting Input Noise Current Density	$f = 1\text{ kHz}$	3		3		3		pA/ $\sqrt{\text{Hz}}$
$i_{n(-)}$	Inverting Input Noise Current Density	$f = 1\text{ kHz}$	16		16		16		pA/ $\sqrt{\text{Hz}}$
e_n	Input Noise Voltage Density	$f = 1\text{ kHz}$	4		4		4		pA/ $\sqrt{\text{Hz}}$
	Second Harmonic Distortion	2 V_{PP} , 10 MHz	-50		-50		-50		dBc
	Third Harmonic Distortion	2 V_{PP} , 10 MHz	-55		-55		-55		
	Differential Gain	$R_L = 150\Omega$	0.05		0.05		0.05		%
		$A_V = +2$							
		NTSC							
	Differential Phase	$R_L = 150\Omega$	0.04		0.04		0.04		Deg
		$A_V = +2$							
		NTSC							

(1) Typical values represent the most likely parametric norm.

(2) All limits ensured at room temperature (standard type face) or at operating temperature extremes (**bold face type**).

(3) Measured from +25% to +75% of output waveform.

±5V DC Electrical Characteristics

The following specifications apply for Supply Voltage = ±5V, $R_F = 820\Omega$, and $R_L = 1\text{ k}\Omega$ unless otherwise noted. **Boldface** limits apply at the temperature extremes; all other limits $T_J = 25^\circ\text{C}$.

Symbol	Parameter	Conditions	LM6181AM		LM6181AI		LM6181I		Units
			Typical ⁽¹⁾	Limit ⁽²⁾	Typical ⁽¹⁾	Limit ⁽²⁾	Typical ⁽¹⁾	Limit ⁽²⁾	
V_{OS}	Input Offset Voltage		1.0	2.0 3.0	1.0	2.0 2.5	1.0	3.0 3.5	mV max
$TC\ V_{OS}$	Input Offset Voltage Drift		2.5		2.5		2.5		$\mu\text{V}/^\circ\text{C}$
I_B	Inverting Input Bias Current		5.0	10 22	5.0	10 22	5.0	17.5 27.0	μA max
	Non-Inverting Input Bias Current		0.25	1.5 1.5	0.25	1.5 1.5	0.25	3.0 5.0	
$TC\ I_B$	Inverting Input Bias Current Drift		50		50		50		nA/ $^\circ\text{C}$
	Non-Inverting Input Bias Current Drift		3.0		3.0		3.0		
I_B PSR	Inverting Input Bias Current Power Supply Rejection	$V_S = \pm 4.0\text{V}, \pm 6.0\text{V}$	0.3	0.5 0.5	0.3	0.5 0.5	0.3	1.0 1.0	$\mu\text{A}/\text{V}$ max
	Non-Inverting Input Bias Current Power Supply Rejection	$V_S = \pm 4.0\text{V}, \pm 6.0\text{V}$	0.05	0.5 0.5	0.05	0.5 0.5	0.05	0.5 0.5	
I_B CMR	Inverting Input Bias Current Common Mode Rejection	$-2.5\text{V} \leq V_{CM} \leq +2.5\text{V}$	0.3	0.5 1.0	0.3	0.5 1.0	0.3	1.0 1.5	
	Non-Inverting Input Bias Current Common Mode Rejection	$-2.5\text{V} \leq V_{CM} \leq +2.5\text{V}$	0.12	0.5 1.0	0.12	0.5 0.5	0.12	0.5 0.5	
CMRR	Common Mode Rejection Ratio	$-2.5\text{V} \leq V_{CM} \leq +2.5\text{V}$	57	50 47	57	50 47	57	50 47	dB min
PSRR	Power Supply Rejection Ratio	$V_S = \pm 4.0\text{V}, \pm 6.0\text{V}$	80	70 70	80	70 70	80	64 64	
R_O	Output Resistance	$A_V = -1, f = 300\text{ kHz}$	0.25		0.25		0.25		Ω
R_{IN}	Non-Inverting Input Resistance		8		8		8		$\text{M}\Omega$ min
V_O	Output Voltage Swing	$R_L = 1\text{ k}\Omega$	2.6	2.25 2.2	2.6	2.25 2.25	2.6	2.25 2.25	V min
		$R_L = 100\Omega$	2.2	2.0 2.0	2.2	2.0 2.0	2.2	2.0 2.0	
I_{SC}	Output Short Circuit Current		100	75 70	100	75 70	100	75 70	mA min
Z_T	Transimpedance	$R_L = 1\text{ k}\Omega$	1.4	0.75 0.35	1.4	0.75 0.4	1.0	0.6 0.3	$\text{M}\Omega$ min
		$R_L = 100\Omega$	1.0	0.5 0.25	1.0	0.5 0.25	1.0	0.4 0.2	
I_S	Supply Current	No Load, $V_O = 0\text{V}$	6.5	8.5 8.5	6.5	8.5 8.5	6.5	8.5 8.5	mA max
V_{CM}	Input Common Mode Voltage Range		$V^+ - 1.7\text{V}$ $V^- + 1.7\text{V}$		$V^+ - 1.7\text{V}$ $V^- + 1.7\text{V}$		$V^+ - 1.7\text{V}$ $V^- + 1.7\text{V}$		V

(1) Typical values represent the most likely parametric norm.

(2) All limits ensured at room temperature (standard type face) or at operating temperature extremes (**bold face type**).

±5V AC Electrical Characteristics

The following specifications apply for Supply Voltage = ±5V, $R_F = 820\Omega$, and $R_L = 1\text{ k}\Omega$ unless otherwise noted. **Boldface** limits apply at the temperature extremes; all other limits $T_J = 25^\circ\text{C}$.

Symbol	Parameter	Conditions	LM6181AM		LM6181AI		LM6181I		Units
			Typical ⁽¹⁾	Limit ⁽²⁾	Typical ⁽¹⁾	Limit ⁽²⁾	Typical ⁽¹⁾	Limit ⁽²⁾	
BW	Closed Loop Bandwidth -3 dB	$A_V = +2$	50		50		50		MHz min
		$A_V = +10$	40		40		40		
		$A_V = -1$	55	35	55	35	55	35	
		$A_V = -10$	35		35		35		
PBW	Power Bandwidth	$A_V = -1$, $V_O = 4$ V_{PP}	40		40		40		
SR	Slew Rate	$A_V = -1$, $V_O = \pm 2V$, $R_L = 150\Omega$ ⁽³⁾	500	375	500	375	500	375	V/ μ s min
t_s	Settling Time (0.1%)	$A_V = -1$, $V_O = \pm 2V$ $R_L = 150\Omega$	50		50		50		ns
t_r , t_f	Rise and Fall Time	$V_O = 1 V_{PP}$	8.5		8.5		8.5		
t_p	Propagation Delay Time	$V_O = 1 V_{PP}$	8		8		8		
$i_{n(+)}$	Non-Inverting Input Noise Current Density	$f = 1\text{ kHz}$	3		3		3		pA/ $\sqrt{\text{Hz}}$
$i_{n(-)}$	Inverting Input Noise Current Density	$f = 1\text{ kHz}$	16		16		16		pA/ $\sqrt{\text{Hz}}$
e_n	Input Noise Voltage Density	$f = 1\text{ kHz}$	4		4		4		pA/ $\sqrt{\text{Hz}}$
	Second Harmonic Distortion	$2 V_{PP}$, 10 MHz	-45		-45		-45		dBc
	Third Harmonic Distortion	$2 V_{PP}$, 10 MHz	-55		-55		-55		
	Differential Gain	$R_L = 150\Omega$ $A_V = +2$ NTSC	0.063		0.063		0.063		%
	Differential Phase	$R_L = 150\Omega$ $A_V = +2$ NTSC	0.16		0.16		0.16		Deg

(1) Typical values represent the most likely parametric norm.

(2) All limits ensured at room temperature (standard type face) or at operating temperature extremes (**bold face type**).

(3) Measured from +25% to +75% of output waveform.

Typical Performance Characteristics

$T_A = 25^\circ\text{C}$ unless otherwise noted

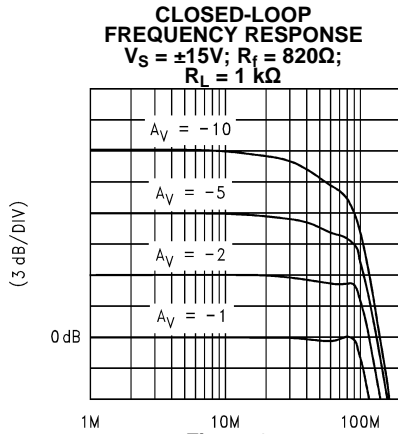

Figure 2.

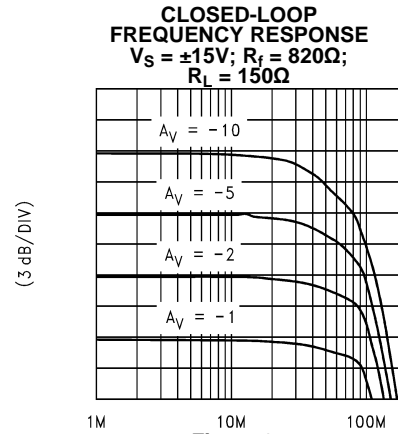

Figure 3.

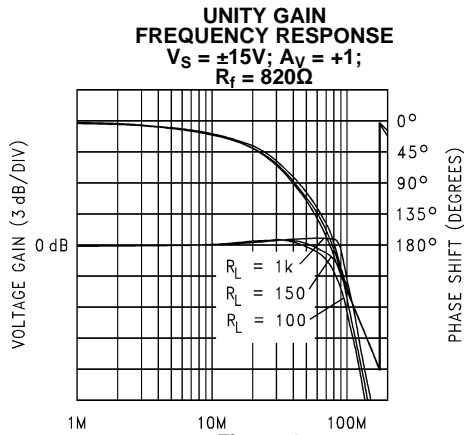

Figure 4.

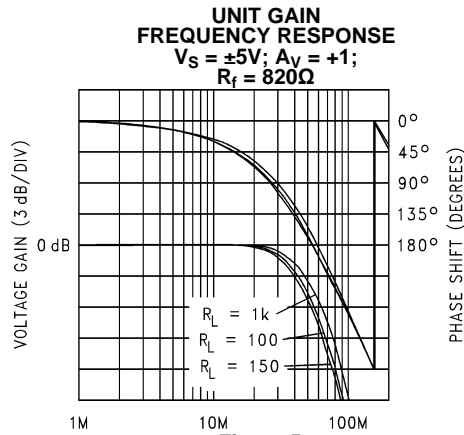

Figure 5.

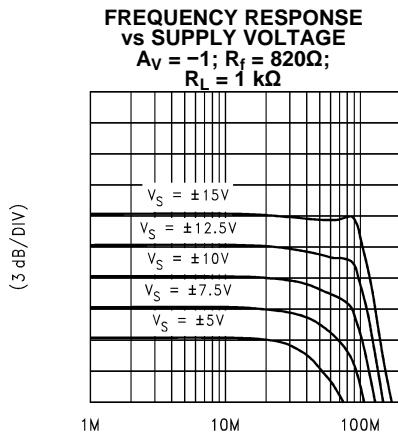

Figure 6.

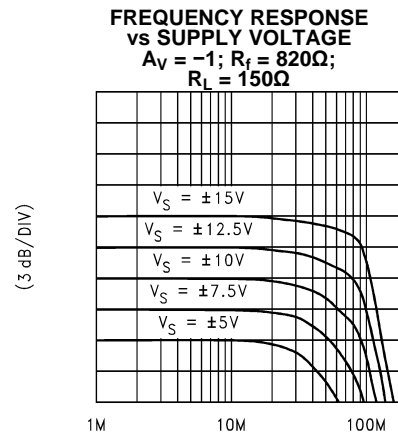

Figure 7.

Typical Performance Characteristics (continued)

T_A = 25°C unless otherwise noted

**INVERTING GAIN
FREQUENCY RESPONSE**
V_S = ±15V; A_V = -1;
R_f = 820Ω

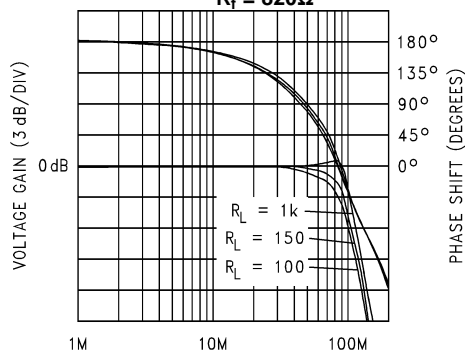

Figure 8.

**INVERTING GAIN
FREQUENCY RESPONSE**
V_S = ±5V; A_V = -1;
R_f = 820Ω

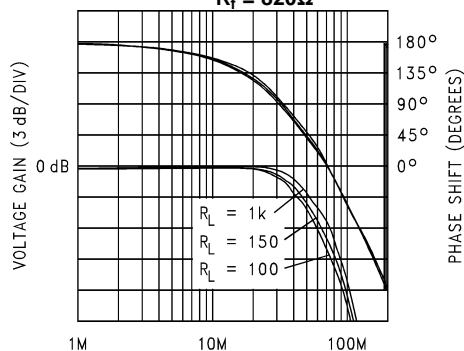

Figure 9.

**NON-INVERTING GAIN
FREQUENCY RESPONSE**
V_S = ±15V; A_V = +2;
R_f = 820Ω

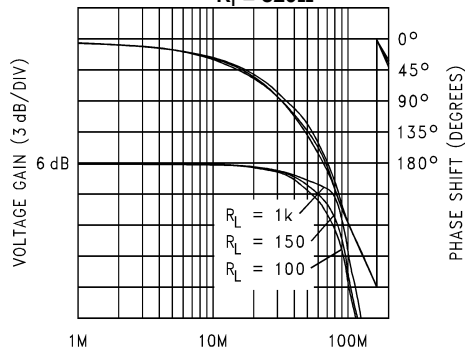

Figure 10.

**NON-INVERTING GAIN
FREQUENCY RESPONSE**
V_S = ±5V; A_V = +2;
R_f = 820Ω

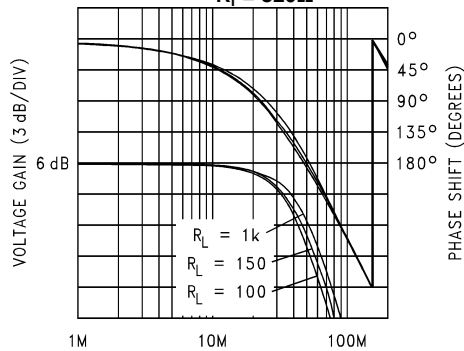

Figure 11.

**INVERTING GAIN
FREQUENCY RESPONSE**
V_S = ±15V; A_V = -10;
R_f = 820Ω

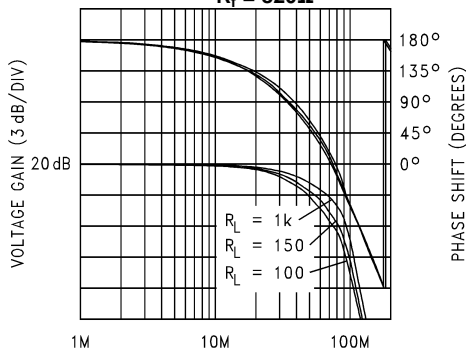

Figure 12.

**INVERTING GAIN
FREQUENCY RESPONSE**
V_S = ±5V; A_V = -10;
R_f = 820Ω

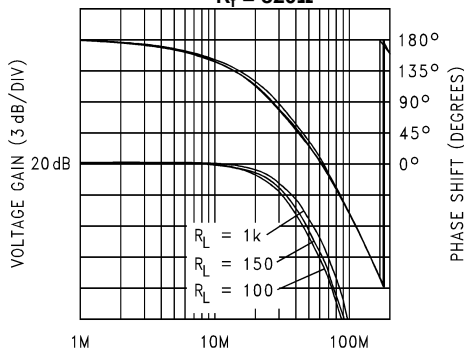

Figure 13.

Typical Performance Characteristics (continued)

T_A = 25°C unless otherwise noted

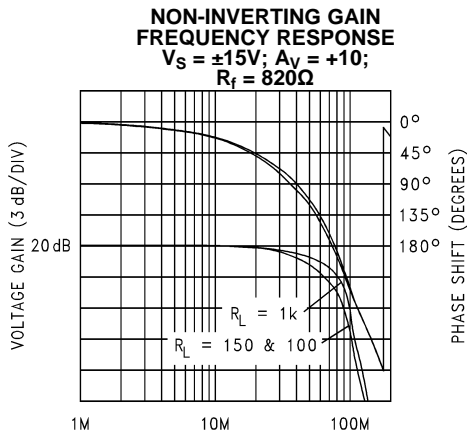

Figure 14.

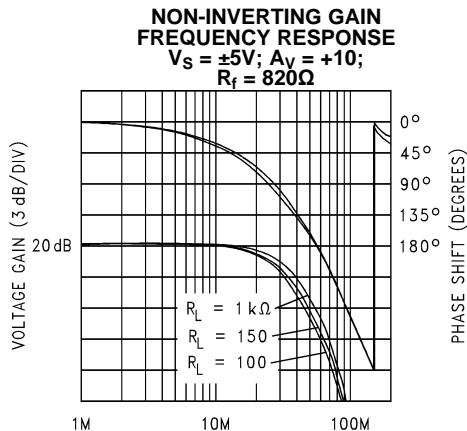

Figure 15.

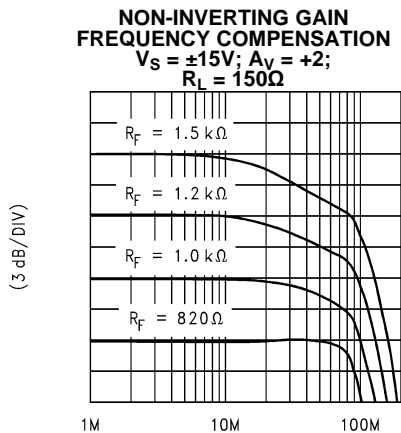

Figure 16.

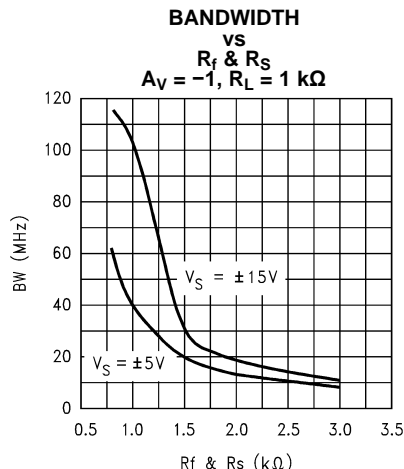

Figure 17.

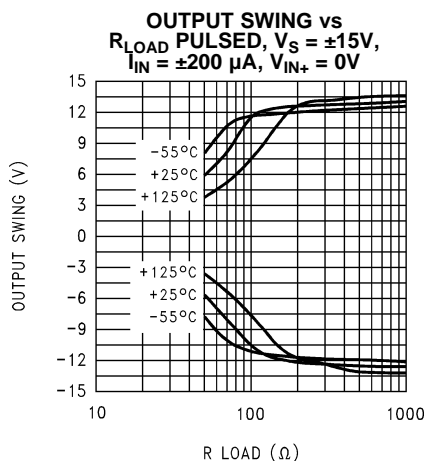

Figure 18.

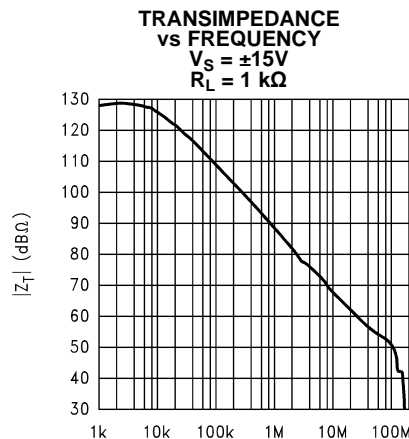

Figure 19.

Typical Performance Characteristics (continued)

T_A = 25°C unless otherwise noted

TRANSIMPEDANCE vs FREQUENCY
 $V_S = \pm 15V$
 $R_L = 100\Omega$

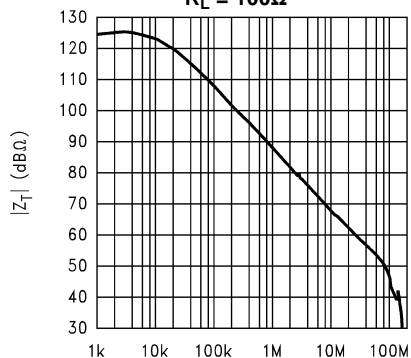

Figure 20.

TRANSIMPEDANCE vs FREQUENCY
 $V_S = \pm 5V$
 $R_L = 1\text{ k}\Omega$

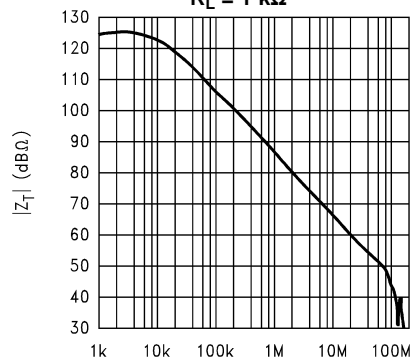

Figure 21.

SETTLING RESPONSE
 $V_S = \pm 15V$; $R_L = 150\Omega$;
 $V_O = \pm 5V$; $A_V = -1$

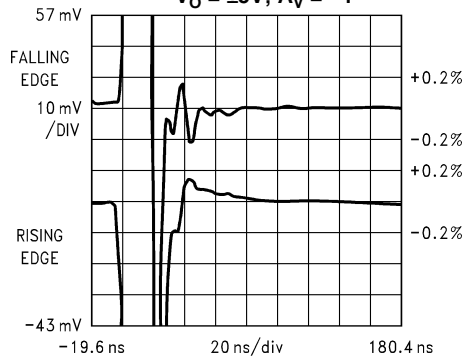

Figure 22.

SETTLING RESPONSE
 $V_S = \pm 5V$; $R_L = 150\Omega$;
 $V_O = \pm 2V$; $A_V = -1$

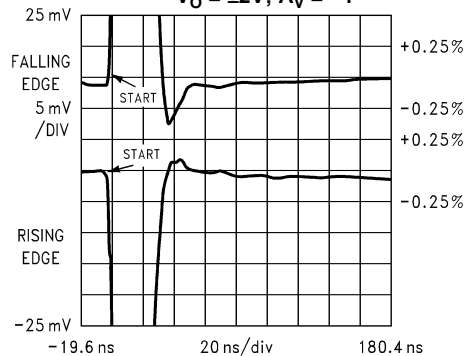

Figure 23.

SUGGESTED R_f and R_s for C_L
 $A_V = -1$; $R_L = 150\Omega$

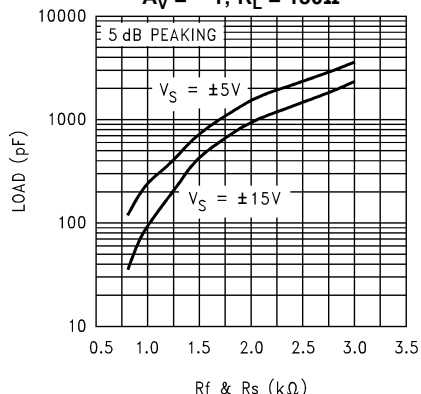

Figure 24.

TRANSIMPEDANCE vs FREQUENCY
 $V_S = \pm 5V$
 $R_L = 100\Omega$

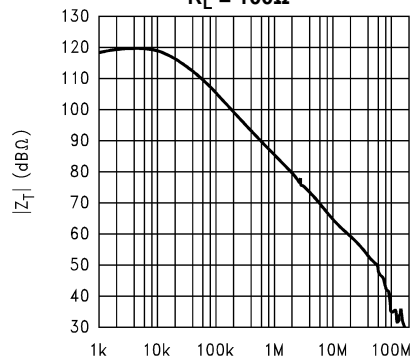

Figure 25.

Typical Performance Characteristics (continued)

$T_A = 25^\circ\text{C}$ unless otherwise noted

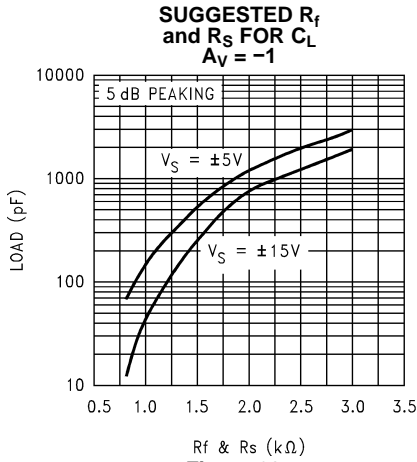

Figure 26.

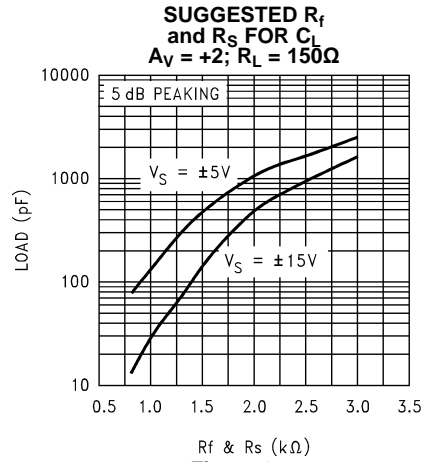

Figure 27.

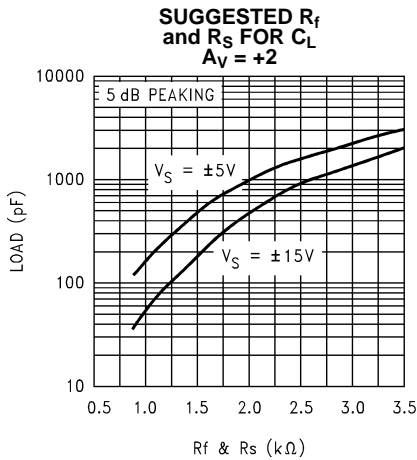

Figure 28.

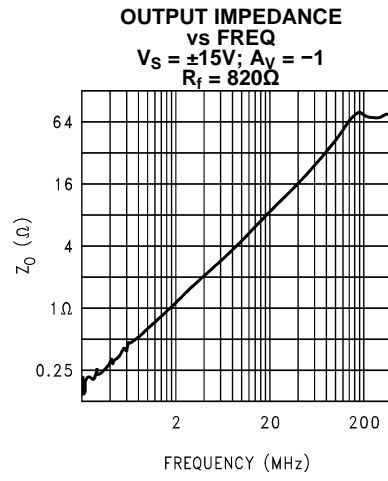

Figure 29.

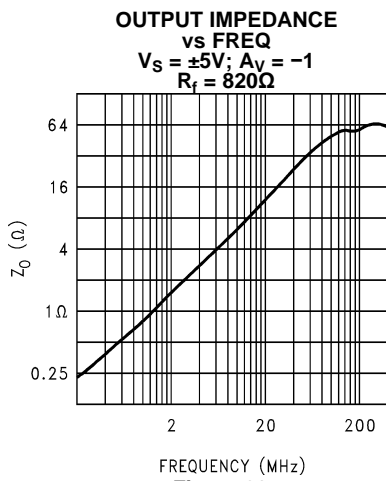

Figure 30.

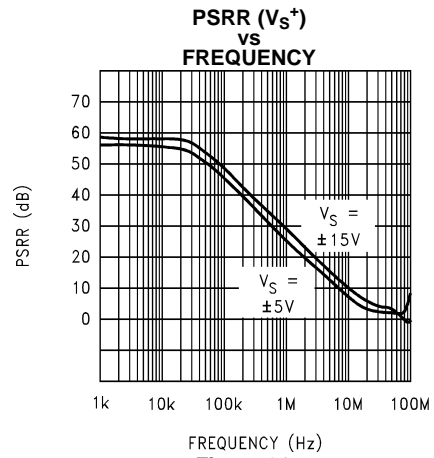

Figure 31.

Typical Performance Characteristics (continued)

T_A = 25°C unless otherwise noted

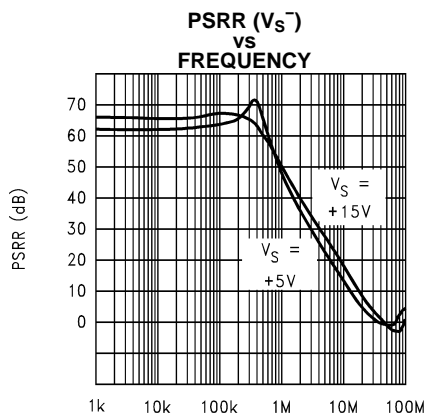

Figure 32.

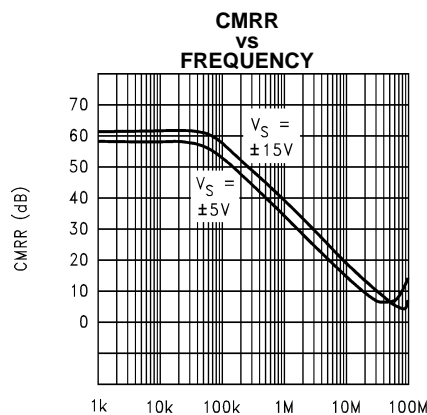

Figure 33.

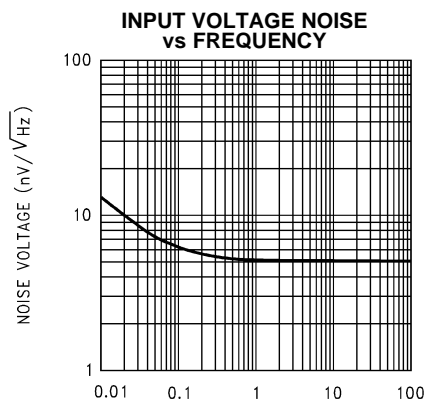

Figure 34.

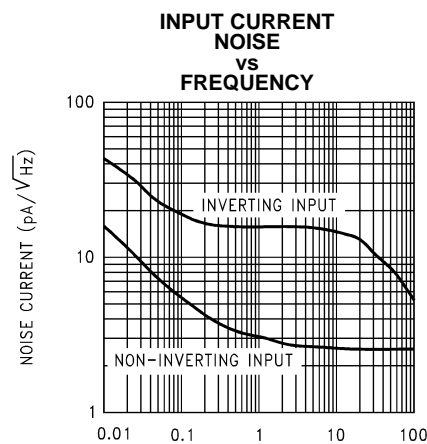

Figure 35.

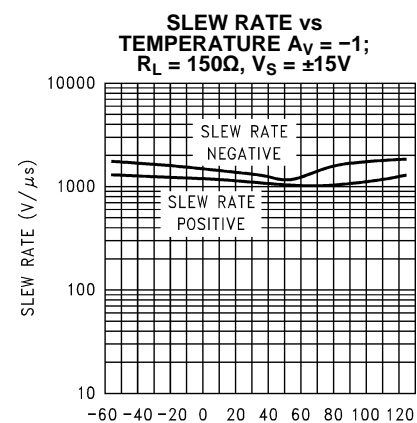

Figure 36.

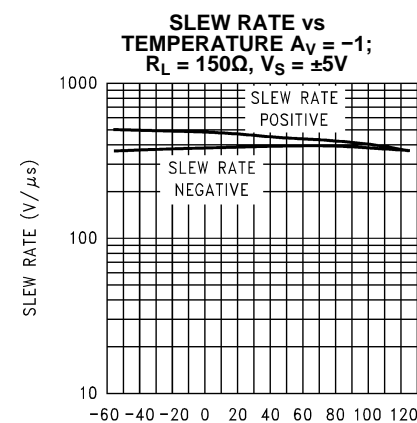
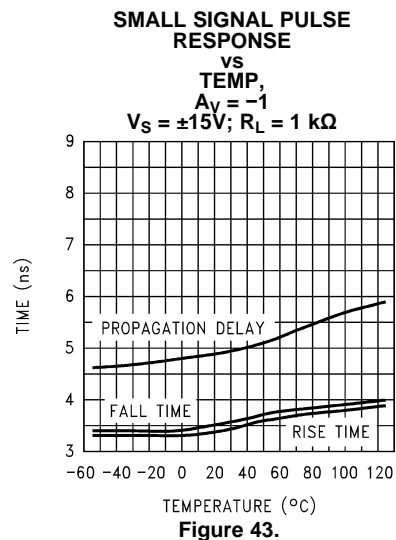
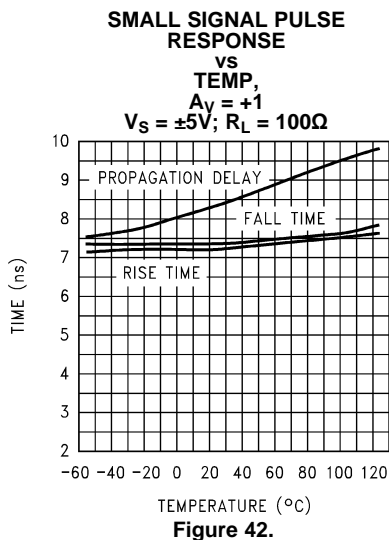
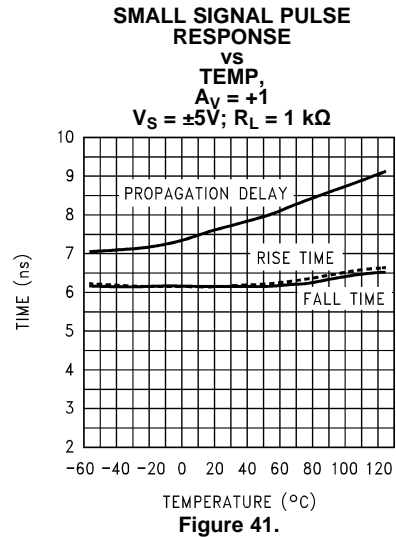
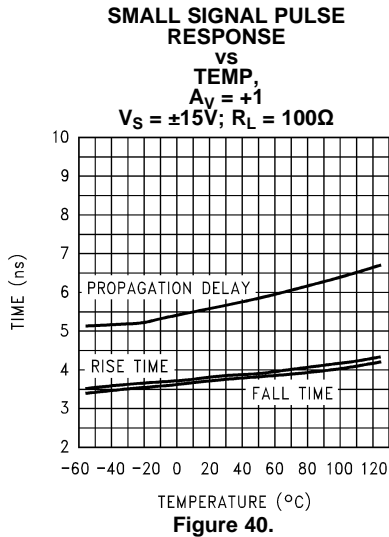
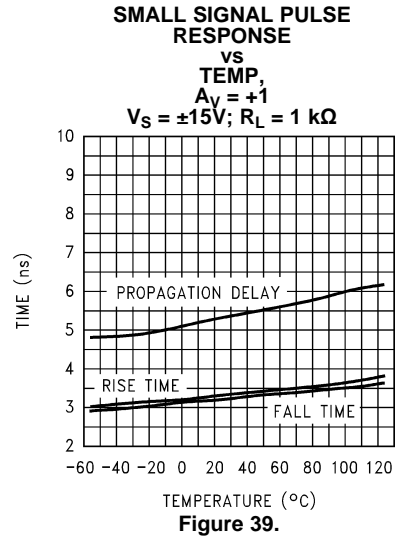
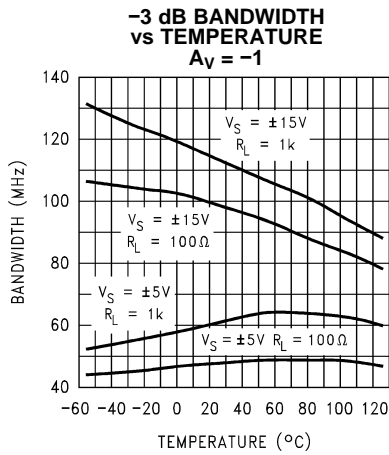

Figure 37.

Typical Performance Characteristics (continued)

$T_A = 25^\circ\text{C}$ unless otherwise noted



Typical Performance Characteristics (continued)

T_A = 25°C unless otherwise noted

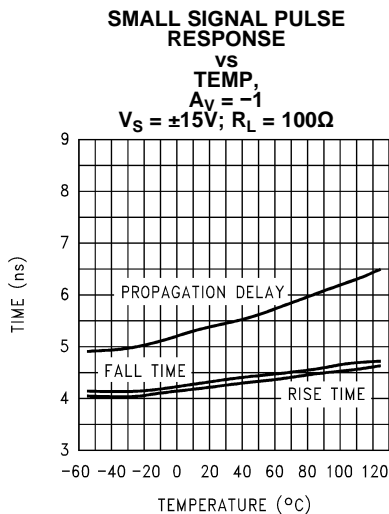

Figure 44.

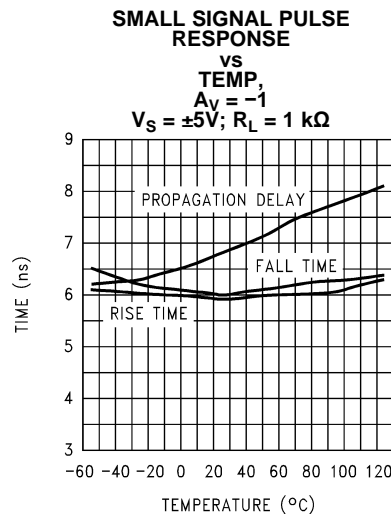

Figure 45.

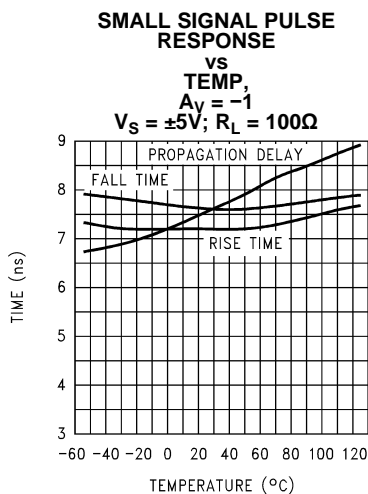

Figure 46.

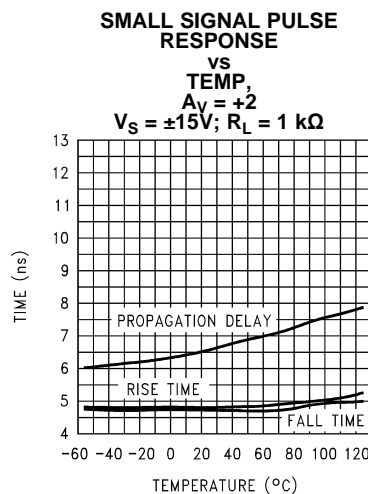

Figure 47.

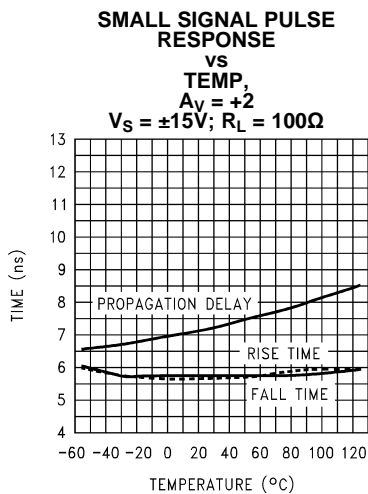

Figure 48.

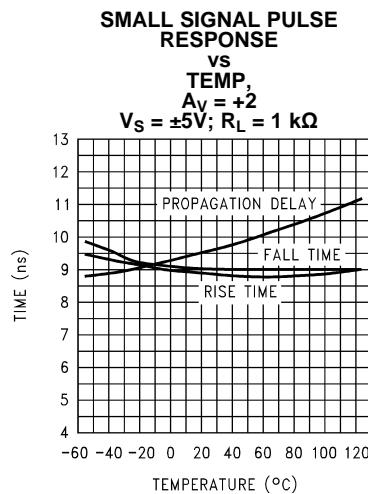

Figure 49.

Typical Performance Characteristics (continued)

$T_A = 25^\circ\text{C}$ unless otherwise noted

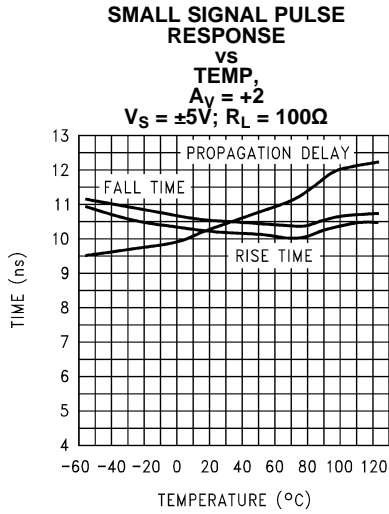

Figure 50.

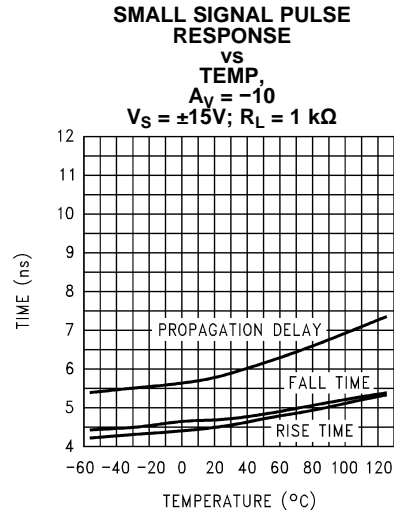

Figure 51.

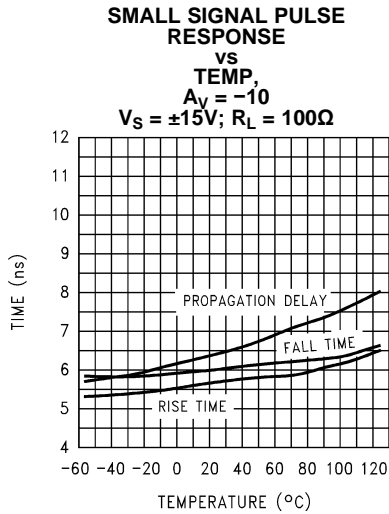

Figure 52.

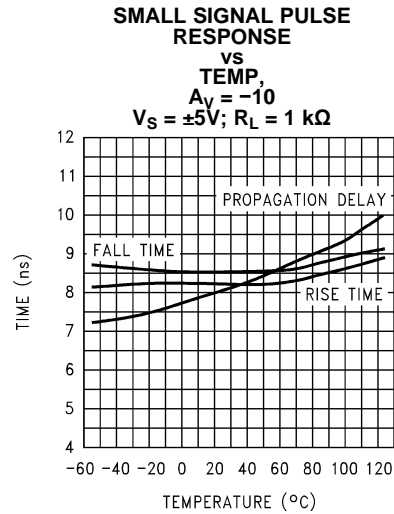

Figure 53.

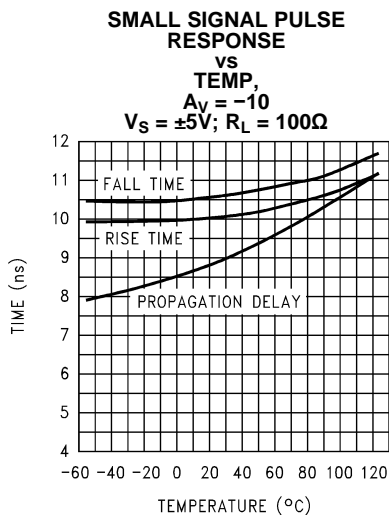

Figure 54.

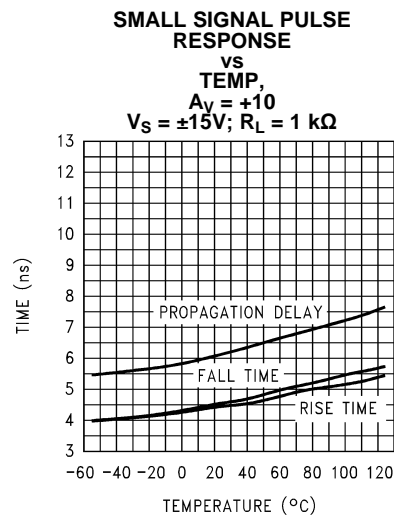

Figure 55.

Typical Performance Characteristics (continued)

T_A = 25°C unless otherwise noted

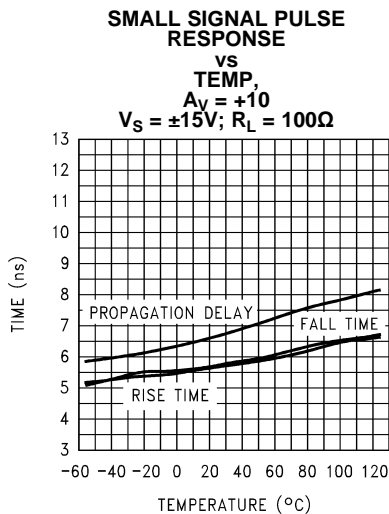

Figure 56.

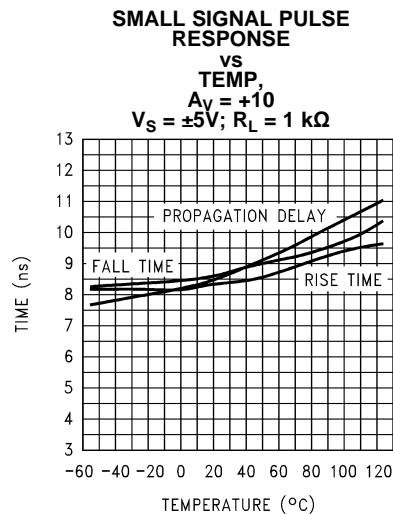

Figure 57.

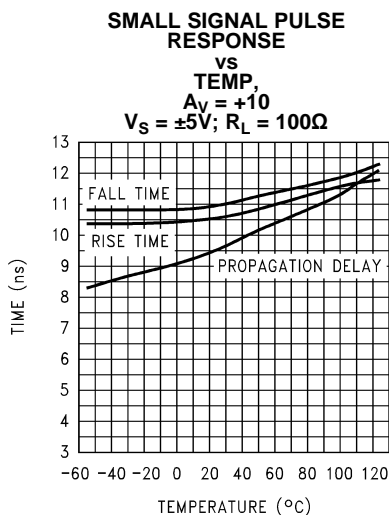

Figure 58.

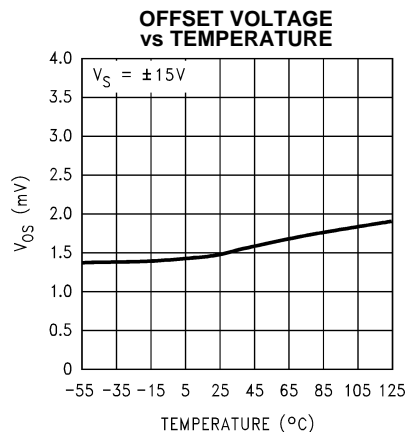

Figure 59.

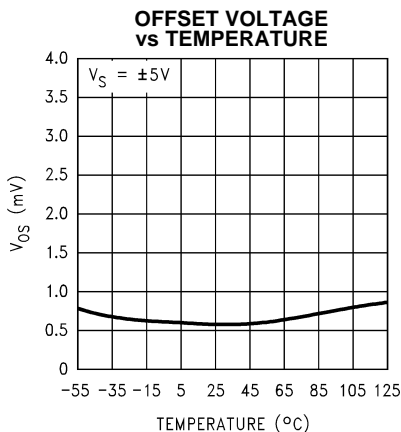

Figure 60.

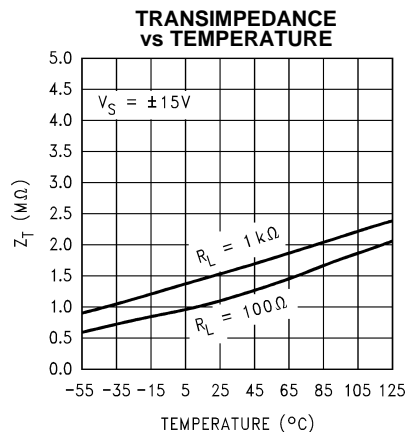
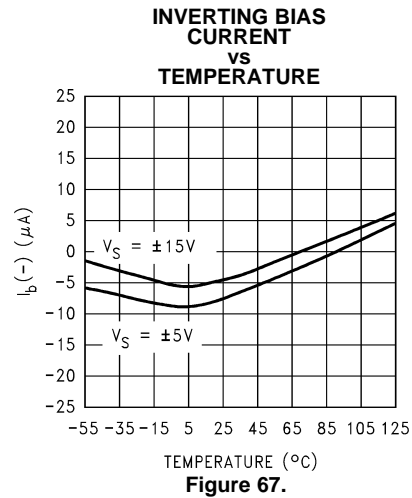
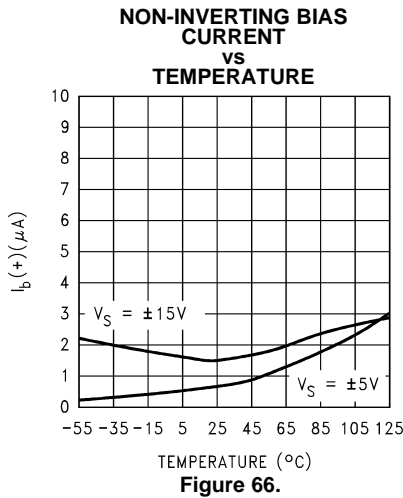
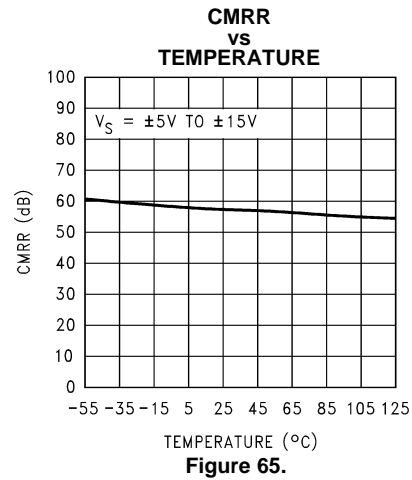
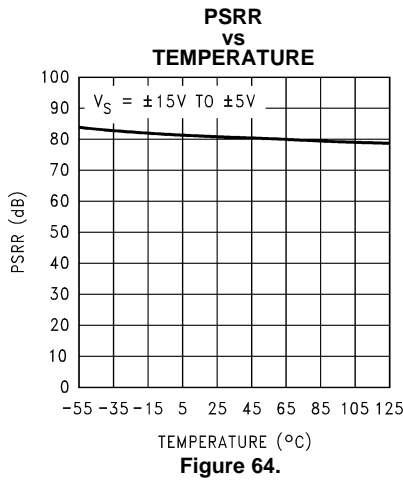
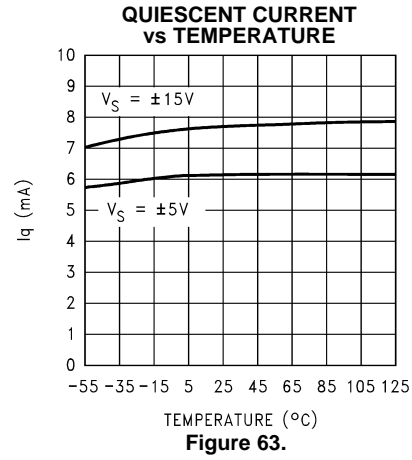
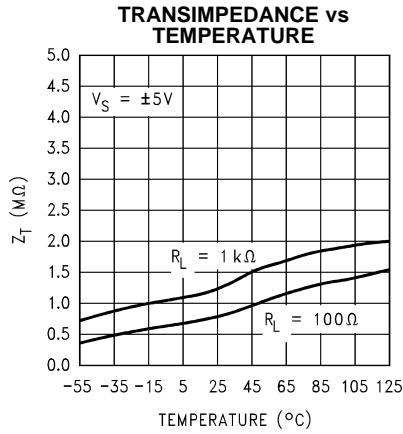

Figure 61.

Typical Performance Characteristics (continued)

$T_A = 25^\circ\text{C}$ unless otherwise noted



Typical Performance Characteristics (continued)

T_A = 25°C unless otherwise noted

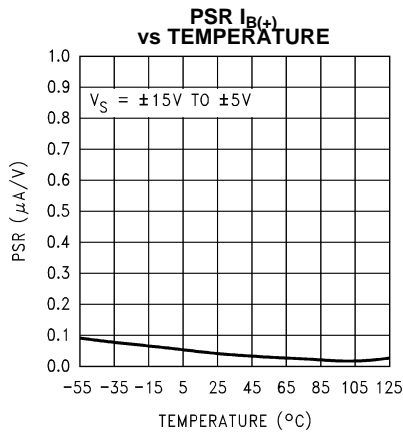

Figure 68.

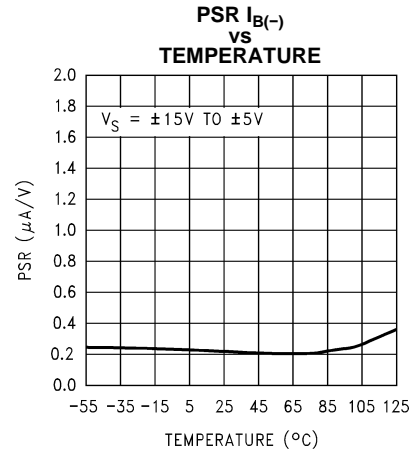

Figure 69.

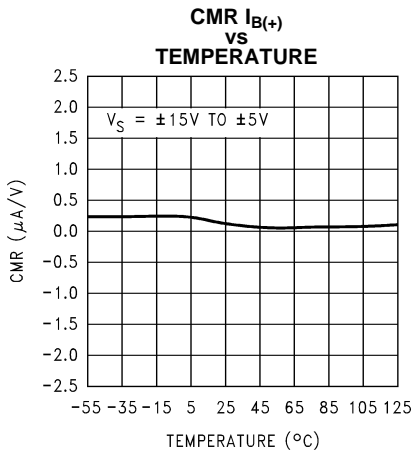

Figure 70.

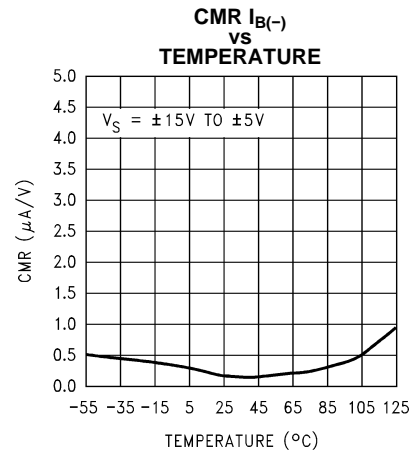

Figure 71.

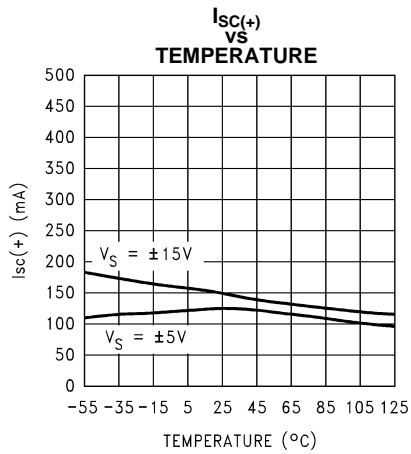

Figure .

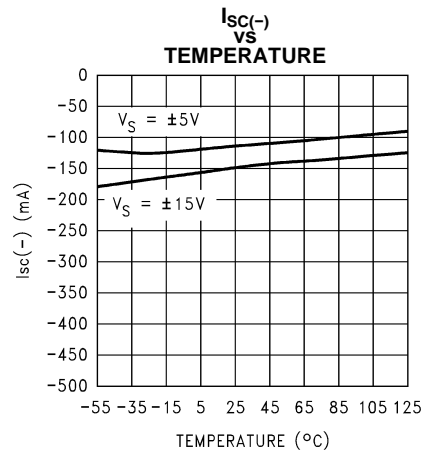

Figure 72.

Typical Performance Characteristics (continued)

T_A = 25°C unless otherwise noted

Absolute Maximum Power Derating Curves

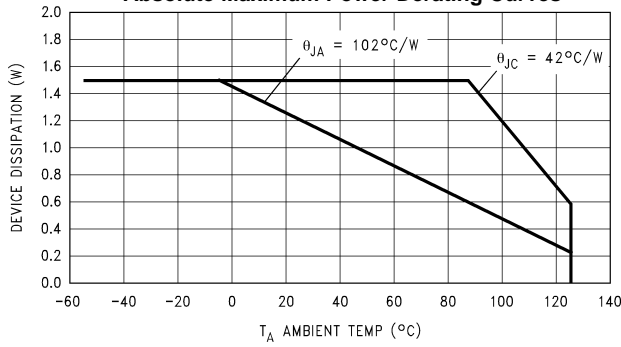

Figure 73. N-Package

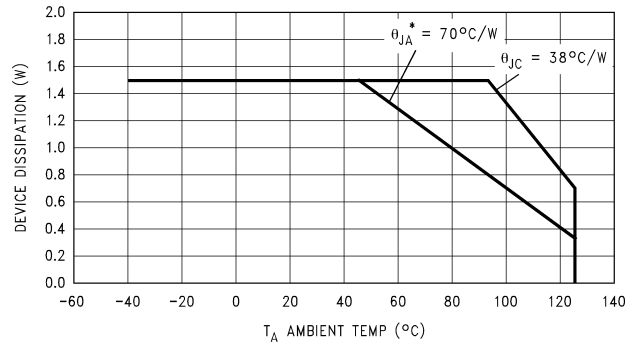

Figure 74. M-Package

*θ_{JA} = Thermal Resistance with 2 square inches of 1 ounce Copper tied to Pins 1, 8, 9 and 16.

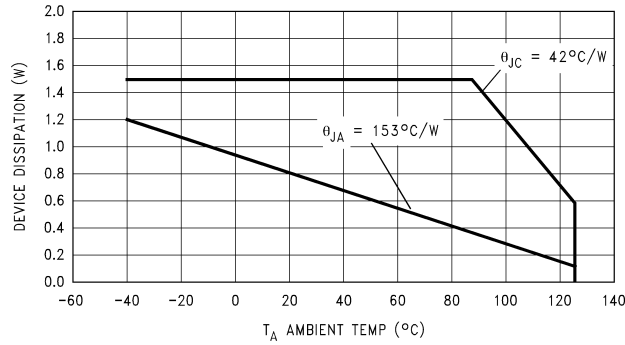

Figure 75. M-8 Package

Simplified Schematic

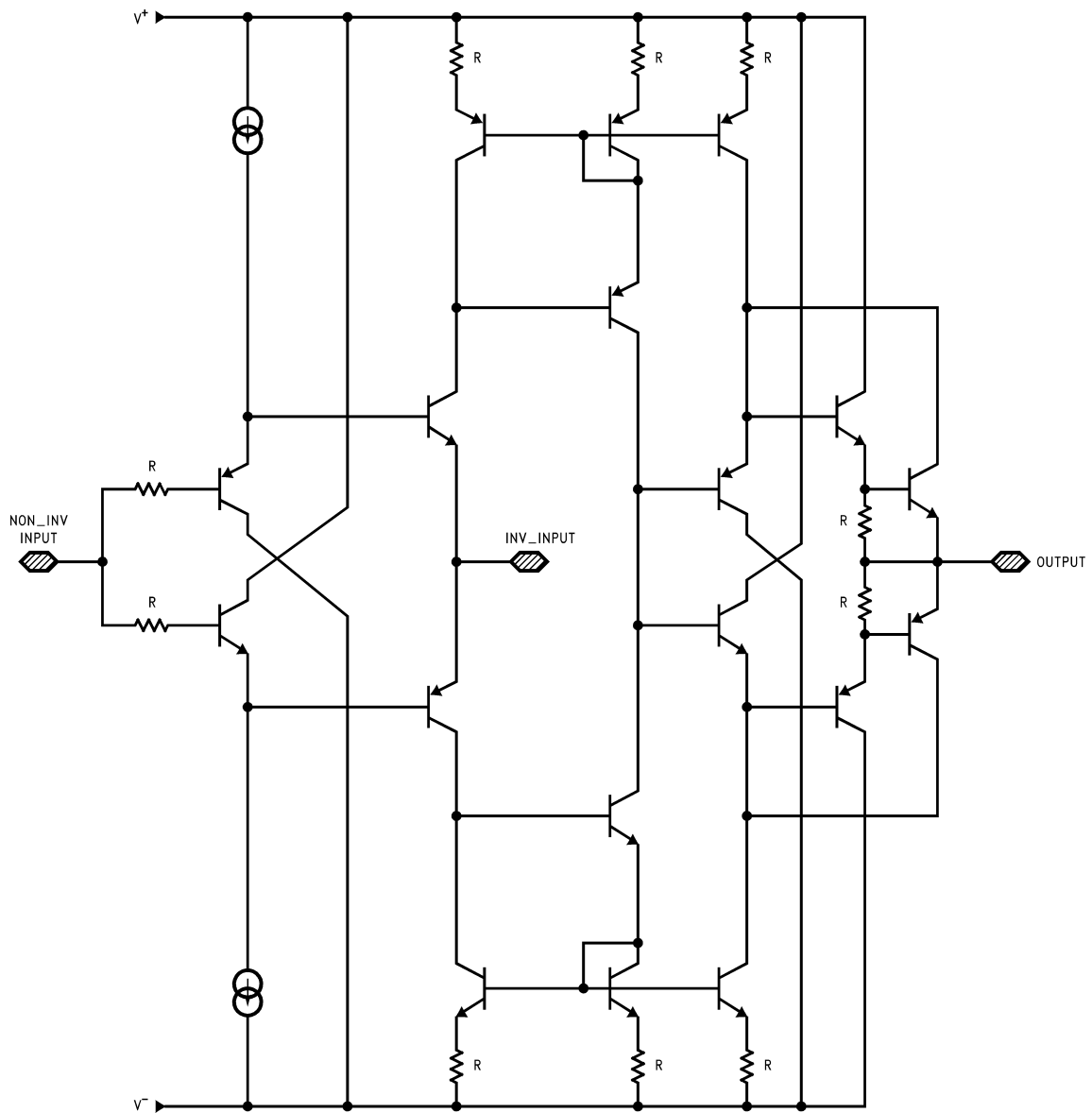

Figure 76.

TYPICAL APPLICATIONS

CURRENT FEEDBACK TOPOLOGY

For a conventional voltage feedback amplifier the resulting small-signal bandwidth is inversely proportional to the desired gain to a first order approximation based on the gain-bandwidth concept. In contrast, the current feedback amplifier topology, such as the LM6181, transcends this limitation to offer a signal bandwidth that is relatively independent of the closed-loop gain. [Figure 77](#) and [Figure 78](#) illustrate that for closed loop gains of -1 and -5 the resulting pulse fidelity suggests quite similar bandwidths for both configurations.

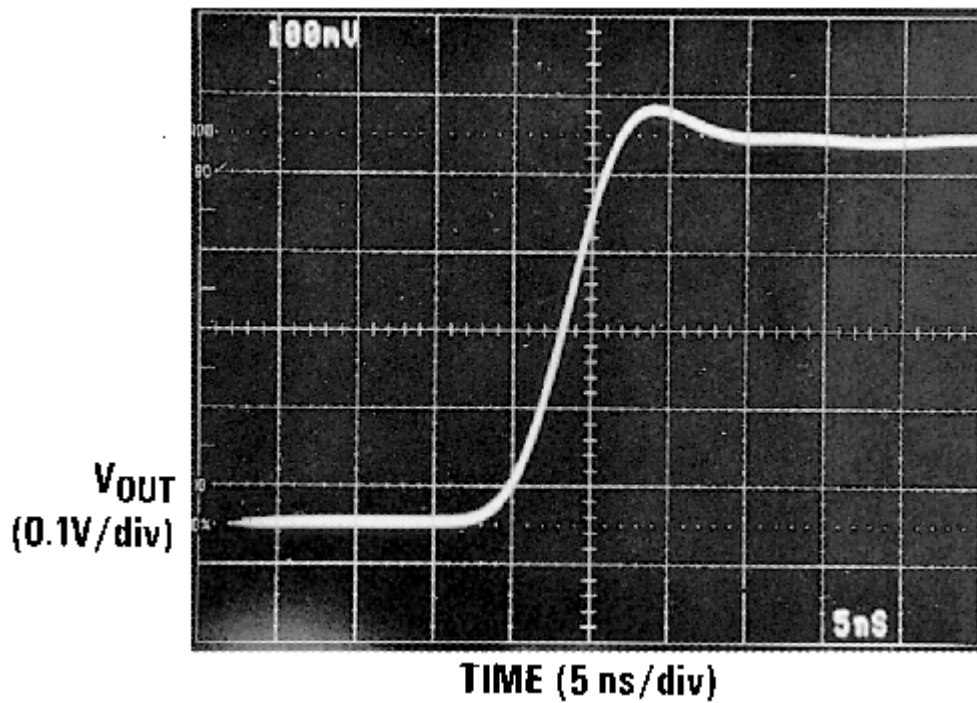
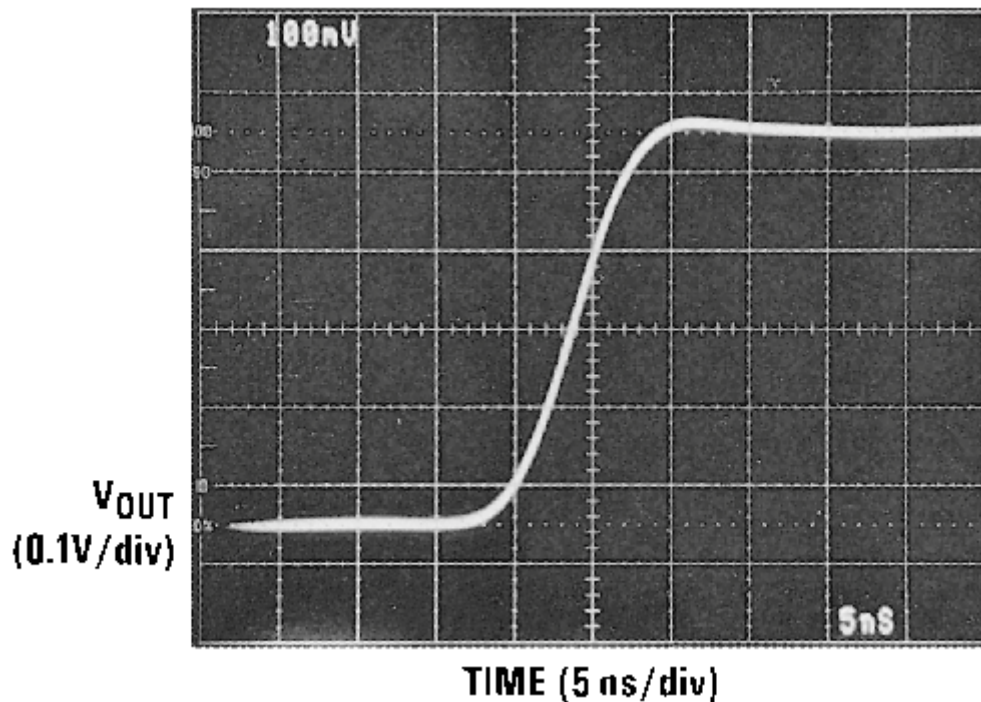

Figure 77.



Variation of Closed Loop Gain
from -1 to -5 Yields Similar Responses

Figure 78.

The closed-loop bandwidth of the LM6181 depends on the feedback resistance, R_f . Therefore, R_s and not R_f , must be varied to adjust for the desired closed-loop gain as in Figure 79.

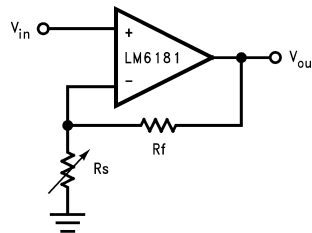

Figure 79. R_s Is Adjusted to Obtain
the Desired Closed Loop Gain, A_{VCL}

POWER SUPPLY BYPASSING AND LAYOUT CONSIDERATIONS

A fundamental requirement for high-speed amplifier design is adequate bypassing of the power supply. It is critical to maintain a wideband low-impedance to ground at the amplifiers supply pins to insure the fidelity of high speed amplifier transient signals. 10 μ F tantalum and 0.1 μ F ceramic bypass capacitors are recommended for each supply pin. The bypass capacitors should be placed as close to the amplifier pins as possible (0.5" or less).

FEEDBACK RESISTOR SELECTION: R_f

Selecting the feedback resistor, R_f , is a dominant factor in compensating the LM6181. For general applications the LM6181 will maintain specified performance with an 820 Ω feedback resistor. Although this value will provide good results for most applications, it may be advantageous to adjust this value slightly. Consider, for instance, the effect on pulse responses with two different configurations where both the closed-loop gains are 2 and the feedback resistors are 820 Ω and 1640 Ω , respectively. Figure 80 and Figure 81 illustrate the effect of increasing

R_f while maintaining the same closed-loop gain—the amplifier bandwidth decreases. Accordingly, larger feedback resistors can be used to slow down the LM6181 (see -3 dB bandwidth vs R_f typical curves) and reduce overshoot in the time domain response. Conversely, smaller feedback resistance values than 820Ω can be used to compensate for the reduction of bandwidth at high closed loop gains, due to 2nd order effects. For example [Figure 82](#) illustrates reducing R_f to 500Ω to establish the desired small signal response in an amplifier configured for a closed loop gain of 25.

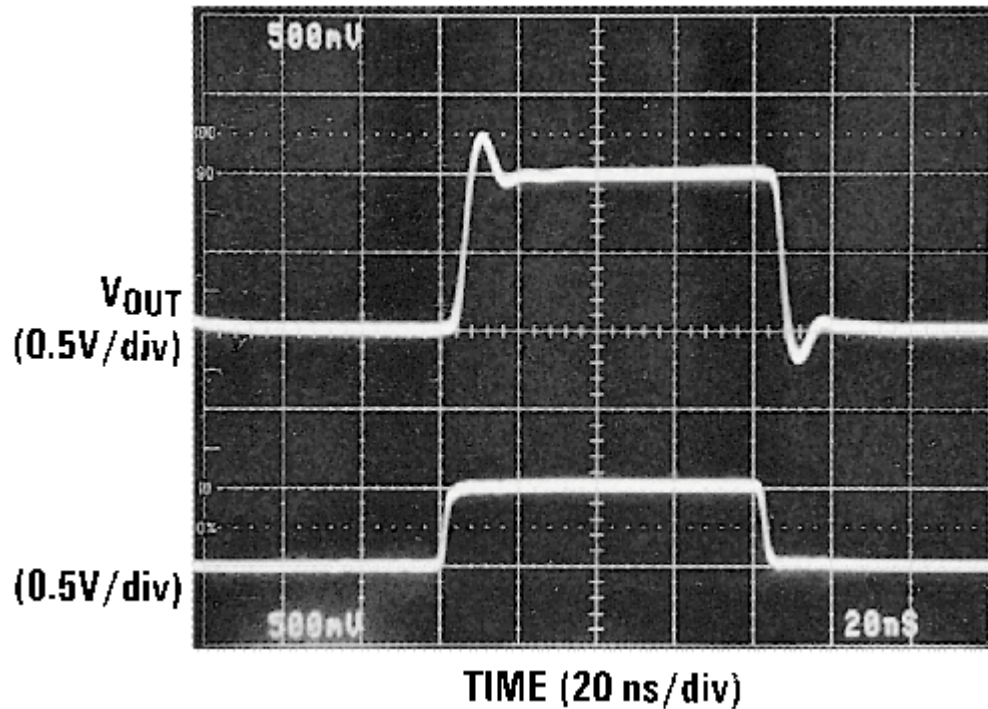
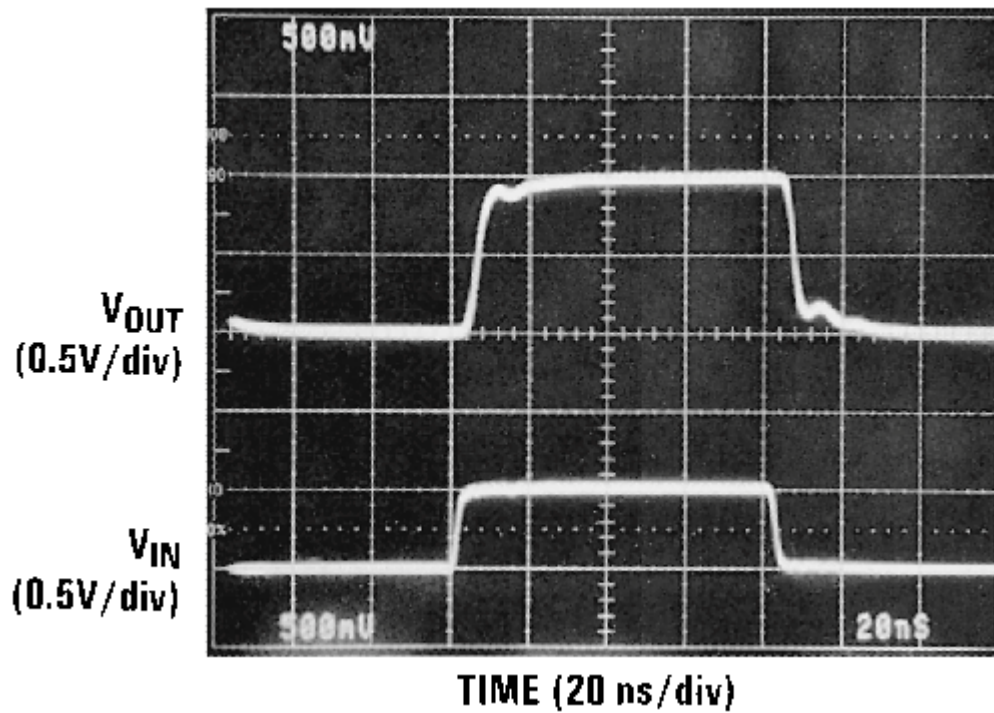

Figure 80. $R_f = 820\Omega$



Increasing Compensation
with Increasing R_f

Figure 81. $R_f = 1640\Omega$

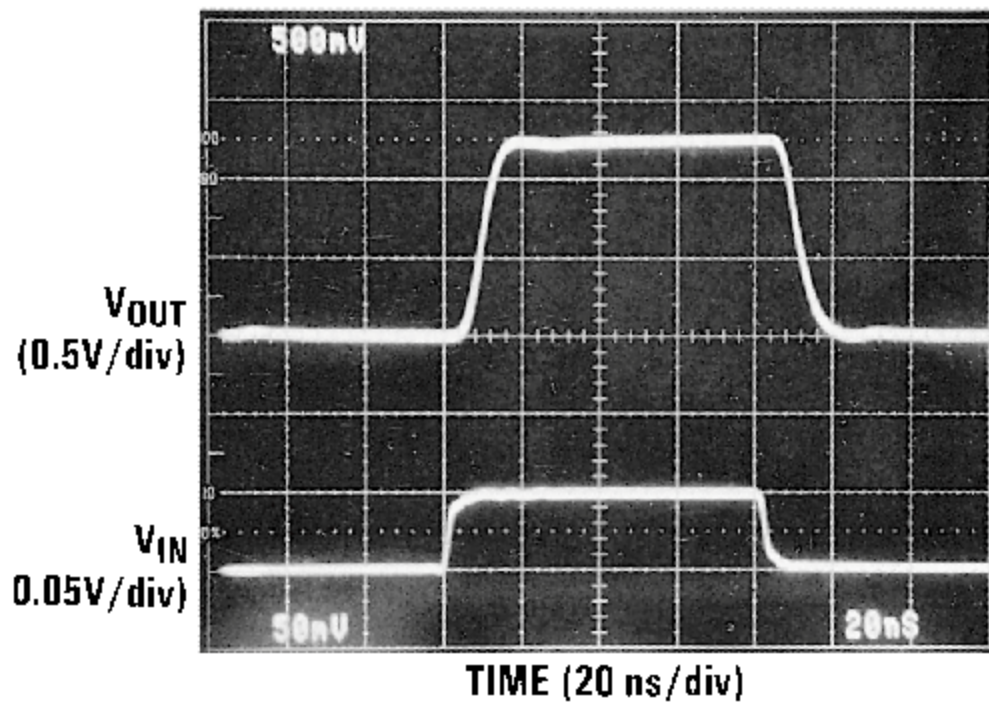

Figure 82. Reducing R_f for Large
Closed Loop Gains, $R_f = 500\Omega$

SLEW RATE CONSIDERATIONS

The slew rate characteristics of current feedback amplifiers are different than traditional voltage feedback amplifiers. In voltage feedback amplifiers slew rate limiting or non-linear amplifier behavior is dominated by the finite availability of the 1st stage tail current charging the compensation capacitor. The slew rate of current feedback amplifiers, in contrast, is not constant. Transient current at the inverting input determines slew rate for both inverting and non-inverting gains. The non-inverting configuration slew rate is also determined by input stage limitations. Accordingly, variations of slew rates occur for different circuit topologies.

DRIVING CAPACITIVE LOADS

The LM6181 can drive significantly larger capacitive loads than many current feedback amplifiers. Although the LM6181 can directly drive as much as 100 pF without oscillating, the resulting response will be a function of the feedback resistor value. [Figure 84](#) illustrates the small-signal pulse response of the LM6181 while driving a 50 pF load. Ringing persists for approximately 70 ns. To achieve pulse responses with less ringing either the feedback resistor can be increased (see typical curves Suggested R_f and R_s for C_L), or resistive isolation can be used (10Ω – 51Ω typically works well). Either technique, however, results in lowering the system bandwidth.

[Figure 86](#) illustrates the improvement obtained with using a 47Ω isolation resistor.

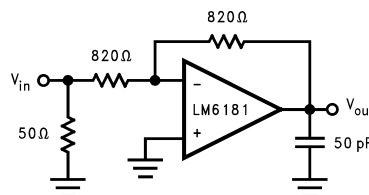

Figure 83.

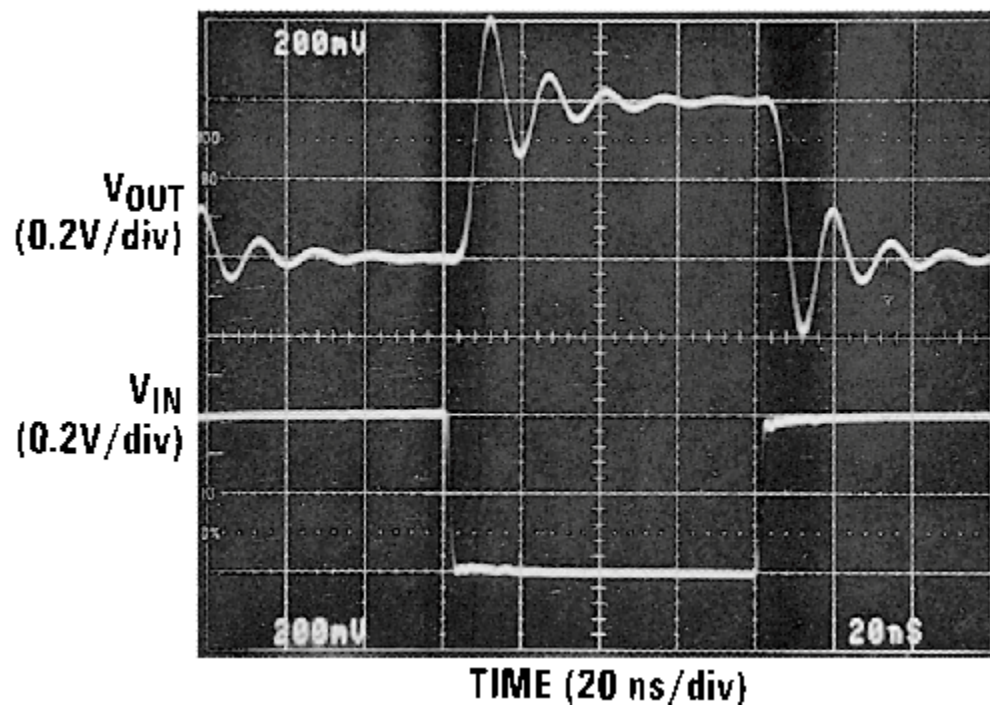

Figure 84. $A_v = -1$, LM6181 Can Directly Drive 50 pF of Load Capacitance with 70 ns of Ringing Resulting in Pulse Response

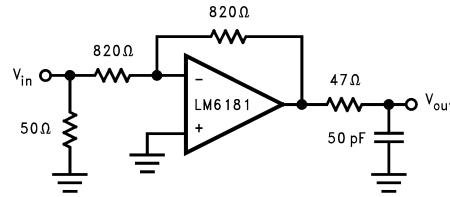
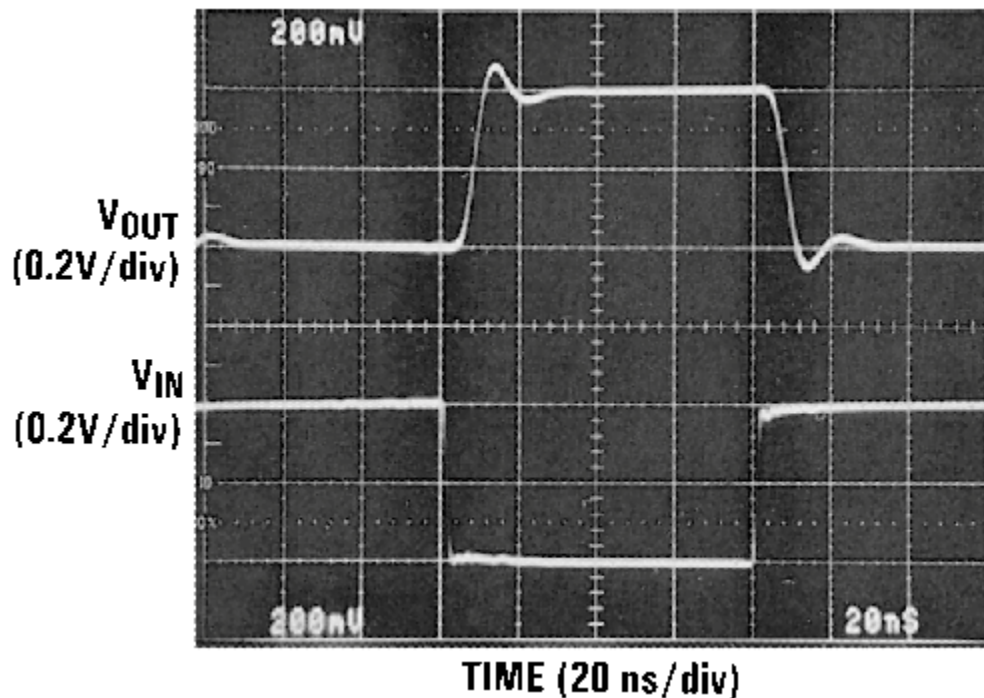

Figure 85.



R_f and R_S Could Be Increased to Maintain $A_V = -1$ and Improve Pulse Response Characteristics.

Figure 86. Resistive Isolation of C_L Provides Higher Fidelity Pulse Response.

CAPACITIVE FEEDBACK

For voltage feedback amplifiers it is quite common to place a small lead compensation capacitor in parallel with feedback resistance, R_f . This compensation serves to reduce the amplifier's peaking in the frequency domain which equivalently tames the transient response. To limit the bandwidth of current feedback amplifiers, do not use a capacitor across R_f . The dynamic impedance of capacitors in the feedback loop reduces the amplifier's stability. Instead, reduced peaking in the frequency response, and bandwidth limiting can be accomplished by adding an RC circuit, as illustrated in [Figure 88](#).

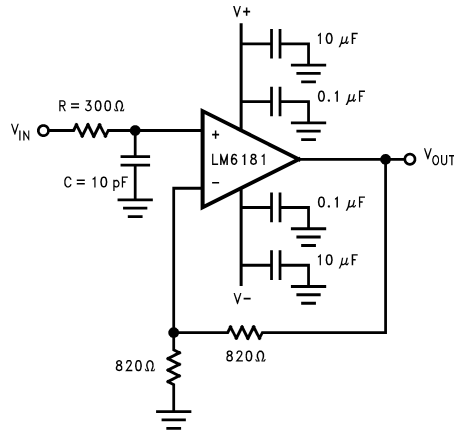

Figure 87.

$$f_{-3\text{ dB}} = \frac{1}{2\pi RC}$$

(1)

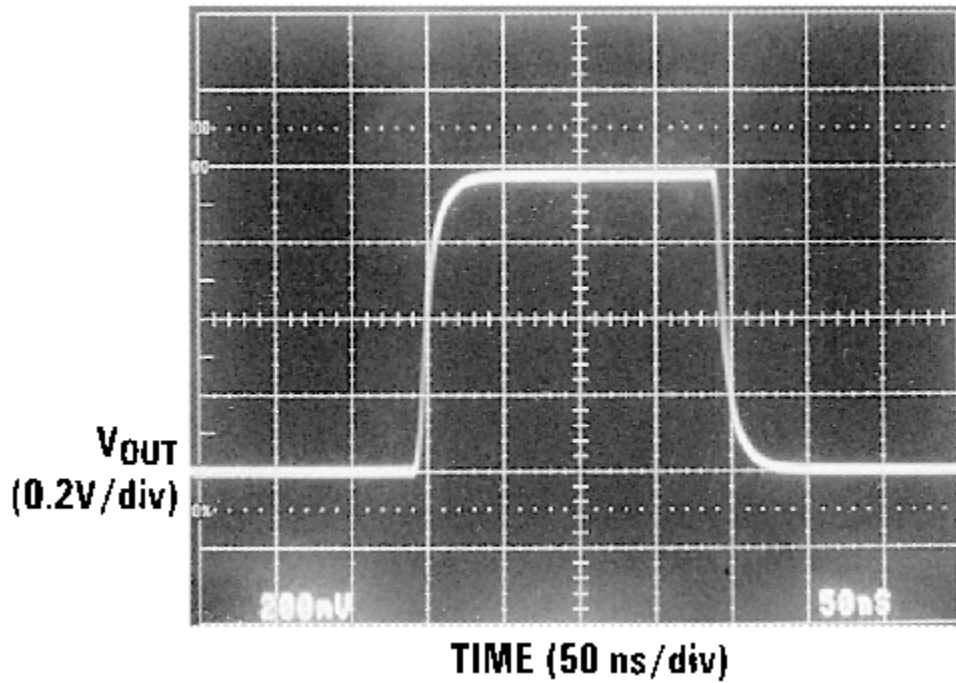

Figure 88. RC Limits Amplifier Bandwidth to 50 MHz, Eliminating Peaking in the Resulting Pulse Response

Typical Performance Characteristics

OVERDRIVE RECOVERY

When the output or input voltage range of a high speed amplifier is exceeded, the amplifier must recover from an overdrive condition. The typical recovery times for open-loop, closed-loop, and input common-mode voltage range overdrive conditions are illustrated in [Figure 90](#), [Figure 92](#), and [Figure 93](#), respectively.

The open-loop circuit of [Figure 89](#) generates an overdrive response by allowing the $\pm 0.5V$ input to exceed the linear input range of the amplifier. Typical positive and negative overdrive recovery times shown in [Figure 90](#) are 5 ns and 25 ns, respectively.

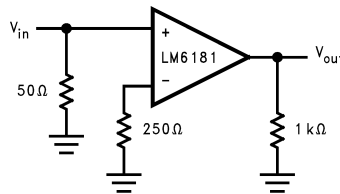

Figure 89.

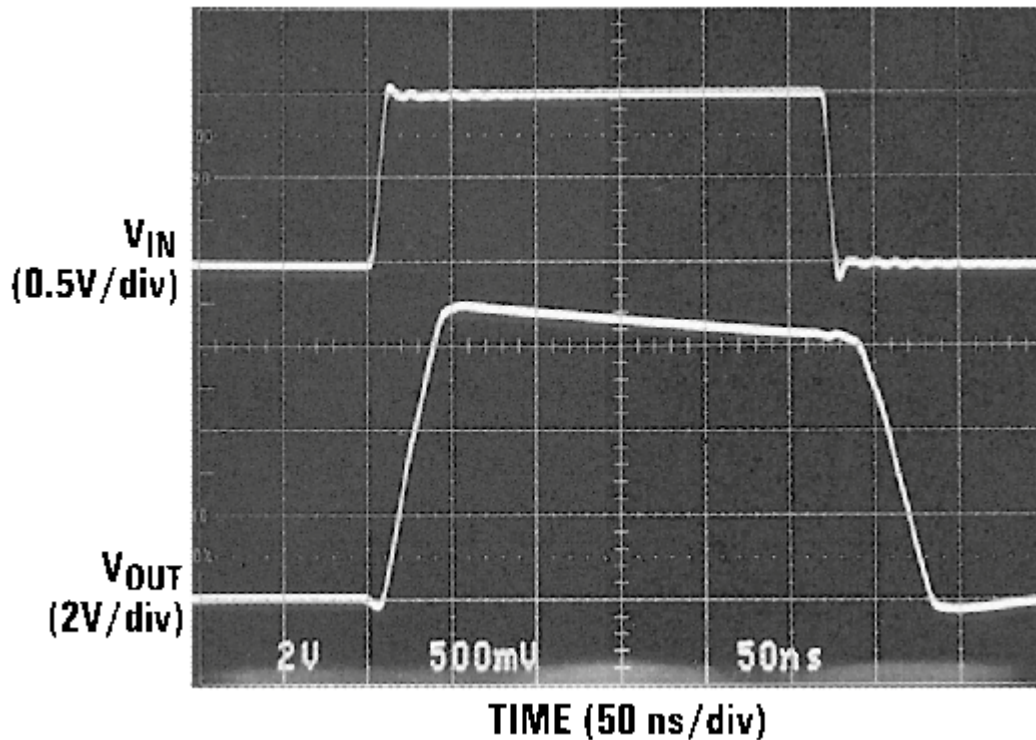

Figure 90. Open-Loop Overdrive Recovery Time of 5 ns, and 25 ns from Test Circuit in [Figure 89](#)

The large closed-loop gain configuration in [Figure 91](#) forces the amplifier output into overdrive. [Figure 92](#) displays the typical 30 ns recovery time to a linear output value.

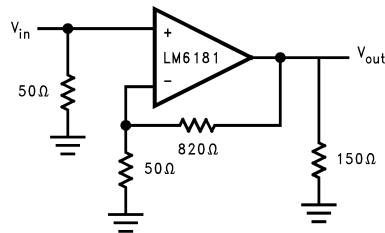

Figure 91.

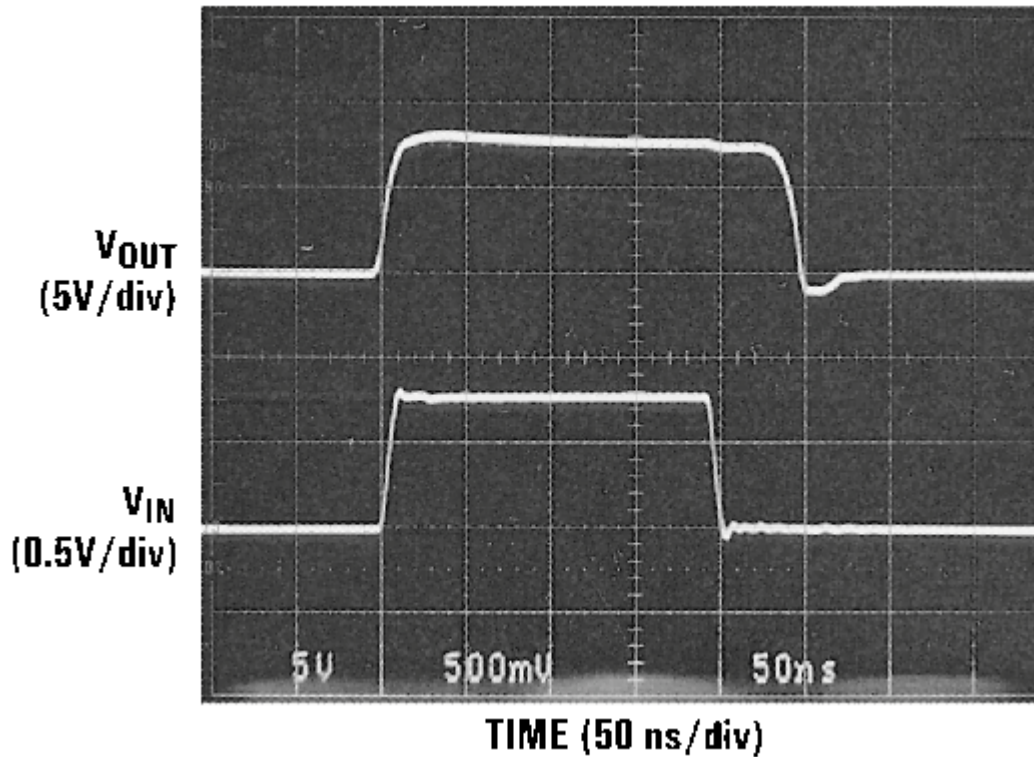

Figure 92. Closed-Loop Overdrive Recovery
Time of 30 ns from Exceeding Output
Voltage Range from Circuit in Figure 91

The common-mode input of the circuit in Figure 91 is exceeded by a 5V pulse resulting in a typical recovery time of 310 ns shown in Figure 93. The LM6181 supply voltage is $\pm 5V$.

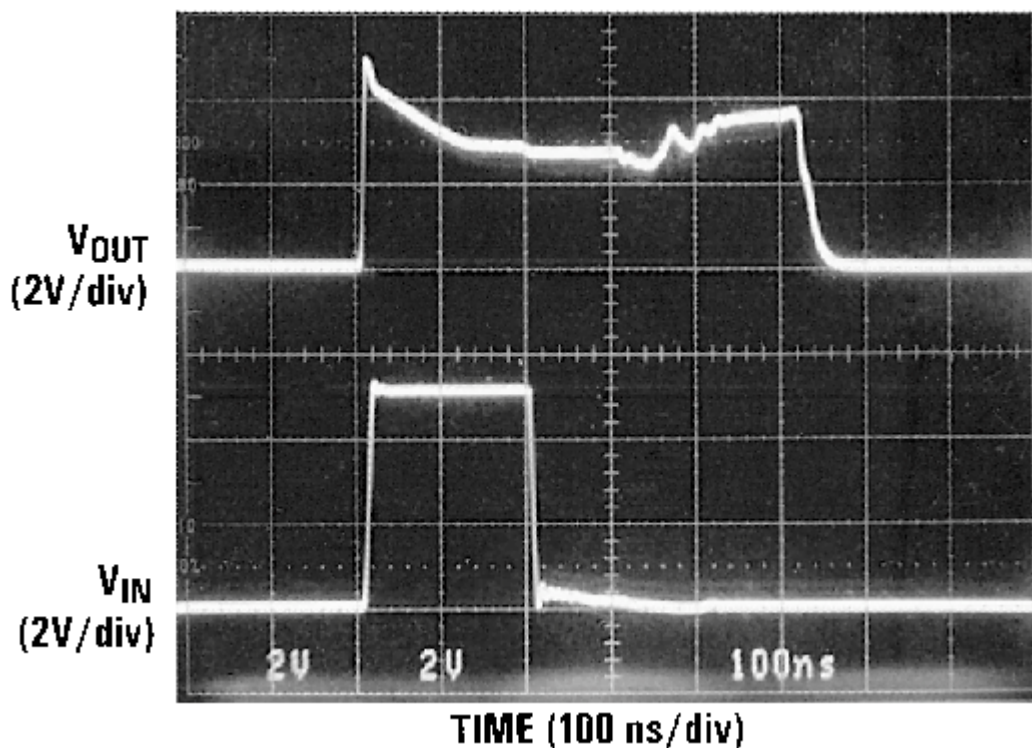

Figure 93. Exceptional Output Recovery from an Input that Exceeds the Common-Mode Range

Connection Diagrams

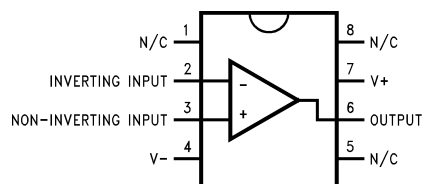
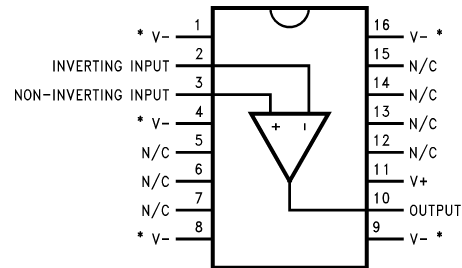

Figure 94. 8-Pin CDIP, PDIP (N), or SOIC (M-8) Package See Package Number NAB, P, or D



*Heat sinking pins⁽¹⁾

Figure 95. 16-Pin SOIC Package (M)
See Package Number D

- (1) The typical junction-to-ambient thermal resistance of the molded PDIP(N) package soldered directly into a PC board is 102°C/W. The junction-to-ambient thermal resistance of the SOIC (M) package mounted flush to the PC board is 70°C/W when pins 1, 4, 8, 9 and 16 are soldered to a total 2 in² 1 oz. copper trace. The 16-pin SOIC (M) package must have pin 4 and at least one of pins 1, 8, 9, or 16 connected to V⁻ for proper operation. The typical junction-to-ambient thermal resistance of the SOIC (M-8) package soldered directly into a PC board is 153°C/W.

REVISION HISTORY

Changes from Revision A (May 2013) to Revision B	Page
<hr/> <ul style="list-style-type: none">• Changed layout of National Data Sheet to TI format	<hr/> 32

PACKAGING INFORMATION

Orderable Device	Status (1)	Package Type	Package Drawing	Pins	Package Qty	Eco Plan (2)	Lead/Ball Finish	MSL Peak Temp (3)	Op Temp (°C)	Top-Side Markings (4)	Samples
LM6181IM-8	ACTIVE	SOIC	D	8	95	TBD	Call TI	Call TI	-40 to 85	LM6181IM8	Samples
LM6181IM-8/NOPB	ACTIVE	SOIC	D	8	95	Green (RoHS & no Sb/Br)	CU SN	Level-1-260C-UNLIM	-40 to 85	LM6181IM8	Samples
LM6181IMX-8/NOPB	ACTIVE	SOIC	D	8	2500	Green (RoHS & no Sb/Br)	CU SN	Level-1-260C-UNLIM	-40 to 85	LM6181IM8	Samples
LM6181IN	ACTIVE	PDIP	P	8	40	TBD	Call TI	Call TI	-40 to 85	LM6181IN	Samples
LM6181IN/NOPB	ACTIVE	PDIP	P	8	40	Green (RoHS & no Sb/Br)	CU SN	Level-1-NA-UNLIM	-40 to 85	LM6181IN	Samples

(1) The marketing status values are defined as follows:

ACTIVE: Product device recommended for new designs.

LIFEBUY: TI has announced that the device will be discontinued, and a lifetime-buy period is in effect.

NRND: Not recommended for new designs. Device is in production to support existing customers, but TI does not recommend using this part in a new design.

PREVIEW: Device has been announced but is not in production. Samples may or may not be available.

OBSOLETE: TI has discontinued the production of the device.

(2) Eco Plan - The planned eco-friendly classification: Pb-Free (RoHS), Pb-Free (RoHS Exempt), or Green (RoHS & no Sb/Br) - please check <http://www.ti.com/productcontent> for the latest availability information and additional product content details.

TBD: The Pb-Free/Green conversion plan has not been defined.

Pb-Free (RoHS): TI's terms "Lead-Free" or "Pb-Free" mean semiconductor products that are compatible with the current RoHS requirements for all 6 substances, including the requirement that lead not exceed 0.1% by weight in homogeneous materials. Where designed to be soldered at high temperatures, TI Pb-Free products are suitable for use in specified lead-free processes.

Pb-Free (RoHS Exempt): This component has a RoHS exemption for either 1) lead-based flip-chip solder bumps used between the die and package, or 2) lead-based die adhesive used between the die and leadframe. The component is otherwise considered Pb-Free (RoHS compatible) as defined above.

Green (RoHS & no Sb/Br): TI defines "Green" to mean Pb-Free (RoHS compatible), and free of Bromine (Br) and Antimony (Sb) based flame retardants (Br or Sb do not exceed 0.1% by weight in homogeneous material)

(3) MSL, Peak Temp. -- The Moisture Sensitivity Level rating according to the JEDEC industry standard classifications, and peak solder temperature.

(4) Multiple Top-Side Markings will be inside parentheses. Only one Top-Side Marking contained in parentheses and separated by a "~" will appear on a device. If a line is indented then it is a continuation of the previous line and the two combined represent the entire Top-Side Marking for that device.

Important Information and Disclaimer: The information provided on this page represents TI's knowledge and belief as of the date that it is provided. TI bases its knowledge and belief on information provided by third parties, and makes no representation or warranty as to the accuracy of such information. Efforts are underway to better integrate information from third parties. TI has taken and continues to take reasonable steps to provide representative and accurate information but may not have conducted destructive testing or chemical analysis on incoming materials and chemicals. TI and TI suppliers consider certain information to be proprietary, and thus CAS numbers and other limited information may not be available for release.

In no event shall TI's liability arising out of such information exceed the total purchase price of the TI part(s) at issue in this document sold by TI to Customer on an annual basis.

TAPE AND REEL INFORMATION



QUADRANT ASSIGNMENTS FOR PIN 1 ORIENTATION IN TAPE



*All dimensions are nominal

Device	Package Type	Package Drawing	Pins	SPQ	Reel Diameter (mm)	Reel Width W1 (mm)	A0 (mm)	B0 (mm)	K0 (mm)	P1 (mm)	W (mm)	Pin1 Quadrant
LM6181IMX-8/NOPB	SOIC	D	8	2500	330.0	12.4	6.5	5.4	2.0	8.0	12.0	Q1

TAPE AND REEL BOX DIMENSIONS



*All dimensions are nominal

Device	Package Type	Package Drawing	Pins	SPQ	Length (mm)	Width (mm)	Height (mm)
LM6181IMX-8/NOPB	SOIC	D	8	2500	367.0	367.0	35.0

P (R-PDIP-T8)

PLASTIC DUAL-IN-LINE PACKAGE



- NOTES:
- A. All linear dimensions are in inches (millimeters).
 - B. This drawing is subject to change without notice.
 - C. Falls within JEDEC MS-001 variation BA.

IMPORTANT NOTICE

Texas Instruments Incorporated and its subsidiaries (TI) reserve the right to make corrections, enhancements, improvements and other changes to its semiconductor products and services per JESD46, latest issue, and to discontinue any product or service per JESD48, latest issue. Buyers should obtain the latest relevant information before placing orders and should verify that such information is current and complete. All semiconductor products (also referred to herein as "components") are sold subject to TI's terms and conditions of sale supplied at the time of order acknowledgment.

TI warrants performance of its components to the specifications applicable at the time of sale, in accordance with the warranty in TI's terms and conditions of sale of semiconductor products. Testing and other quality control techniques are used to the extent TI deems necessary to support this warranty. Except where mandated by applicable law, testing of all parameters of each component is not necessarily performed.

TI assumes no liability for applications assistance or the design of Buyers' products. Buyers are responsible for their products and applications using TI components. To minimize the risks associated with Buyers' products and applications, Buyers should provide adequate design and operating safeguards.

TI does not warrant or represent that any license, either express or implied, is granted under any patent right, copyright, mask work right, or other intellectual property right relating to any combination, machine, or process in which TI components or services are used. Information published by TI regarding third-party products or services does not constitute a license to use such products or services or a warranty or endorsement thereof. Use of such information may require a license from a third party under the patents or other intellectual property of the third party, or a license from TI under the patents or other intellectual property of TI.

Reproduction of significant portions of TI information in TI data books or data sheets is permissible only if reproduction is without alteration and is accompanied by all associated warranties, conditions, limitations, and notices. TI is not responsible or liable for such altered documentation. Information of third parties may be subject to additional restrictions.

Resale of TI components or services with statements different from or beyond the parameters stated by TI for that component or service voids all express and any implied warranties for the associated TI component or service and is an unfair and deceptive business practice. TI is not responsible or liable for any such statements.

Buyer acknowledges and agrees that it is solely responsible for compliance with all legal, regulatory and safety-related requirements concerning its products, and any use of TI components in its applications, notwithstanding any applications-related information or support that may be provided by TI. Buyer represents and agrees that it has all the necessary expertise to create and implement safeguards which anticipate dangerous consequences of failures, monitor failures and their consequences, lessen the likelihood of failures that might cause harm and take appropriate remedial actions. Buyer will fully indemnify TI and its representatives against any damages arising out of the use of any TI components in safety-critical applications.

In some cases, TI components may be promoted specifically to facilitate safety-related applications. With such components, TI's goal is to help enable customers to design and create their own end-product solutions that meet applicable functional safety standards and requirements. Nonetheless, such components are subject to these terms.

No TI components are authorized for use in FDA Class III (or similar life-critical medical equipment) unless authorized officers of the parties have executed a special agreement specifically governing such use.

Only those TI components which TI has specifically designated as military grade or "enhanced plastic" are designed and intended for use in military/aerospace applications or environments. Buyer acknowledges and agrees that any military or aerospace use of TI components which have **not** been so designated is solely at the Buyer's risk, and that Buyer is solely responsible for compliance with all legal and regulatory requirements in connection with such use.

TI has specifically designated certain components as meeting ISO/TS16949 requirements, mainly for automotive use. In any case of use of non-designated products, TI will not be responsible for any failure to meet ISO/TS16949.

Products

Audio	www.ti.com/audio
Amplifiers	amplifier.ti.com
Data Converters	dataconverter.ti.com
DLP® Products	www.dlp.com
DSP	dsp.ti.com
Clocks and Timers	www.ti.com/clocks
Interface	interface.ti.com
Logic	logic.ti.com
Power Mgmt	power.ti.com
Microcontrollers	microcontroller.ti.com
RFID	www.ti-rfid.com
OMAP Applications Processors	www.ti.com/omap
Wireless Connectivity	www.ti.com/wirelessconnectivity

Applications

Automotive and Transportation	www.ti.com/automotive
Communications and Telecom	www.ti.com/communications
Computers and Peripherals	www.ti.com/computers
Consumer Electronics	www.ti.com/consumer-apps
Energy and Lighting	www.ti.com/energy
Industrial	www.ti.com/industrial
Medical	www.ti.com/medical
Security	www.ti.com/security
Space, Avionics and Defense	www.ti.com/space-avionics-defense
Video and Imaging	www.ti.com/video

TI E2E Community

e2e.ti.com