

# LM7121

*LM7121 235 MHz Tiny Low Power Voltage Feedback Amplifier*



Literature Number: SNOS750

# LM7121

## 235 MHz Tiny Low Power Voltage Feedback Amplifier

### General Description

The LM7121 is a high performance operational amplifier which addresses the increasing AC performance needs of video and imaging applications, and the size and power constraints of portable applications.

The LM7121 can operate over a wide dynamic range of supply voltages, from 5V (single supply) up to  $\pm 15V$  (see the Application Information section for more details). It offers an excellent speed-power product delivering  $1300V/\mu s$  and 235 MHz Bandwidth ( $-3\text{ dB}$ ,  $A_V = +1$ ). Another key feature of this operational amplifier is stability while driving unlimited capacitive loads.

Due to its Tiny SOT23-5 package, the LM7121 is ideal for designs where space and weight are the critical parameters. The benefits of the Tiny package are evident in small portable electronic devices, such as cameras, and PC video cards. Tiny amplifiers are so small that they can be placed anywhere on a board close to the signal source or near the input to an A/D converter.

### Features

(Typical unless otherwise noted)  $V_S = \pm 15V$

- Easy to use voltage feedback topology
- Stable with unlimited capacitive loads
- Tiny SOT23-5 package — typical circuit layout takes half the space of SO-8 designs
- Unity gain frequency: 175 MHz
- Bandwidth ( $-3\text{ dB}$ ,  $A_V = +1$ ,  $R_L = 100\Omega$ ): 235 MHz
- Slew rate:  $1300V/\mu s$
- Supply Voltages SO-8: 5V to  $\pm 15V$   
SOT23-5: 5V to  $\pm 5V$
- Characterized for:  $+5V$ ,  $\pm 5V$ ,  $\pm 15V$
- Low supply current: 5.3 mA

### Applications

- Scanners, color fax, digital copiers
- PC video cards
- Cable drivers
- Digital cameras
- ADC/DAC buffers
- Set-top boxes

### Connection Diagrams

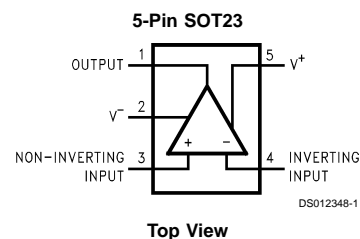
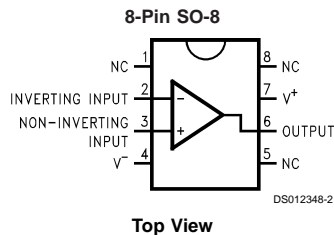

### Ordering Information

Package	Ordering Information	NSC Drawing Number	Package Marking	Supplied As
8-Pin SO-8	LM7121IM	M08A	LM7121IM	Rails
	LM7121IMX	M08A	LM7121IM	2.5k Tape and Reel
5-Pin SOT23-5	LM7121IM5	MA05A	A03A	1k Tape and Reel
	LM7121IM5X	MA05A	A03A	3k Tape and Reel

### Absolute Maximum Ratings (Note 1)

If Military/Aerospace specified devices are required, please contact the National Semiconductor Sales Office/Distributors for availability and specifications.

ESD Tolerance (Note 2)	2000V
Differential Input Voltage (Note 7)	±2V
Voltage at Input/Output Pin	(V <sup>+</sup> )−1.4V, (V <sup>-</sup> ) +1.4V
Supply Voltage (V <sup>+</sup> −V <sup>-</sup> )	36V
Output Short Circuit to Ground (Note 3)	Continuous
Lead Temperature	260°C
(soldering, 10 sec)	260°C

Storage Temperature Range	−65°C to +150°C
Junction Temperature (Note 4)	150°C

### Operating Ratings (Note 1)

Supply Voltage: SO-8	4.5V ≤ V <sub>S</sub> ≤ 33V
SOT23-5	4.5V ≤ V <sub>S</sub> ≤ 11V
Junction Temperature Range	−40°C ≤ T <sub>J</sub> ≤ +85°C
Thermal Resistance (θ <sub>JA</sub> )	
M Package, 8-pin Surface Mount	165°C/W
SOT23-5 Package	325°C/W

### ±15V DC Electrical Characteristics

Unless otherwise specified, all limits guaranteed for T<sub>J</sub> = 25°C, V<sup>+</sup> = +15V, V<sup>-</sup> = −15V, V<sub>CM</sub> = V<sub>O</sub> = 0V and R<sub>L</sub> > 1 MΩ. **Boldface** limits apply at the temperature extremes.

Symbol	Parameter	Conditions	Typ (Note 5)	LM71211 Limit (Note 6)	Units
V <sub>OS</sub>	Input Offset Voltage		0.9	8 <b>15</b>	mV max
I <sub>B</sub>	Input Bias Current		5.2	9.5 <b>12</b>	μA max
I <sub>OS</sub>	Input Offset Current		0.04	4.3 <b>7</b>	μA max
R <sub>IN</sub>	Input Resistance	Common Mode	10		MΩ
		Differential Mode	3.4		MΩ
C <sub>IN</sub>	Input Capacitance	Common Mode	2.3		pF
CMRR	Common Mode Rejection Ratio	−10V ≤ V <sub>CM</sub> ≤ 10V	93	73 <b>70</b>	dB min
+PSRR	Positive Power Supply Rejection Ratio	10V ≤ V <sup>+</sup> ≤ 15V	86	70 <b>68</b>	dB min
−PSRR	Negative Power Supply Rejection Ratio	−15V ≤ V <sup>-</sup> ≤ −10V	81	68 <b>65</b>	dB min
V <sub>CM</sub>	Input Common-Mode Voltage Range	CMRR ≥ 70 dB	13	11	V min
			−13	−11	V max
A <sub>V</sub>	Large Signal Voltage Gain	R <sub>L</sub> = 2 kΩ, V <sub>O</sub> = 20 V <sub>PP</sub>	72	65 <b>57</b>	dB min
V <sub>O</sub>	Output Swing	R <sub>L</sub> = 2 kΩ	13.4	11.1 <b>10.8</b>	V min
			−13.4	−11.2 <b>−11.0</b>	V max
		R <sub>L</sub> = 150Ω	10.2	7.75 <b>7.0</b>	V min
			−7.0	−5.0 <b>−4.8</b>	V max
I <sub>SC</sub>	Output Short Circuit Current	Sourcing	71	54 <b>44</b>	mA min
		Sinking	52	39 <b>34</b>	mA min

### ±15V DC Electrical Characteristics (Continued)

Unless otherwise specified, all limits guaranteed for  $T_J = 25^\circ\text{C}$ ,  $V^+ = +15\text{V}$ ,  $V^- = -15\text{V}$ ,  $V_{\text{CM}} = V_O = 0\text{V}$  and  $R_L > 1\text{ M}\Omega$ . **Boldface** limits apply at the temperature extremes.

Symbol	Parameter	Conditions	Typ (Note 5)	LM71211 Limit (Note 6)	Units
$I_S$	Supply Current		5.3	6.6 <b>7.5</b>	mA max

### ±15V AC Electrical Characteristics

Unless otherwise specified, all limits guaranteed for  $T_J = 25^\circ\text{C}$ ,  $V^+ = 15\text{V}$ ,  $V^- = -15\text{V}$ ,  $V_{\text{CM}} = V_O = 0\text{V}$  and  $R_L > 1\text{ M}\Omega$ . **Boldface** limits apply at the temperature extremes.

Symbol	Parameter	Conditions	Typ (Note 5)	LM71211 Limit (Note 6)	Units
SR	Slew Rate (Note 8)	$A_V = +2$ , $R_L = 1\text{ k}\Omega$ , $V_O = 20 V_{\text{PP}}$	1300		V/ $\mu\text{s}$
GBW	Unity Gain-Bandwidth	$R_L = 1\text{ k}\Omega$	175		MHz
$\phi_m$	Phase Margin		63		Deg
$f$ (-3 dB)	Bandwidth (Notes 9, 10)	$R_L = 100\Omega$ , $A_V = +1$ $R_L = 100\Omega$ , $A_V = +2$	235 50		MHz
$t_s$	Settling Time	10 $V_{\text{PP}}$ Step, to 0.1%, $R_L = 500\Omega$	74		ns
$t_r$ , $t_f$	Rise and Fall Time (Note 10)	$A_V = +2$ , $R_L = 100\Omega$ , $V_O = 0.4 V_{\text{PP}}$	5.3		ns
$A_D$	Differential Gain	$A_V = +2$ , $R_L = 150\Omega$	0.3		%
$\phi_D$	Differential Phase	$A_V = +2$ , $R_L = 150\Omega$	0.65		Deg
$e_n$	Input-Referred Voltage Noise	$f = 10\text{ kHz}$	17		$\frac{\text{nV}}{\sqrt{\text{Hz}}}$
$i_n$	Input-Referred Current Noise	$f = 10\text{ kHz}$	1.9		$\frac{\text{pA}}{\sqrt{\text{Hz}}}$
T.H.D.	Total Harmonic Distortion	2 $V_{\text{PP}}$ Output, $R_L = 150\Omega$ , $A_V = +2$ , $f = 1\text{ MHz}$ 2 $V_{\text{PP}}$ Output, $R_L = 150\Omega$ , $A_V = +2$ , $f = 5\text{ MHz}$	0.065 0.52		%

### ±5V DC Electrical Characteristics

Unless otherwise specified, all limits guaranteed for  $T_J = 25^\circ\text{C}$ ,  $V^+ = 5\text{V}$ ,  $V^- = -5\text{V}$ ,  $V_{\text{CM}} = V_O = 0\text{V}$  and  $R_L > 1\text{ M}\Omega$ . **Boldface** limits apply at the temperature extremes.

Symbol	Parameter	Conditions	Typ (Note 5)	LM71211 Limit (Note 6)	Units
$V_{\text{OS}}$	Input Offset Voltage		1.6	8 <b>15</b>	mV max
$I_B$	Input Bias Current		5.5	9.5 <b>12</b>	$\mu\text{A}$ max
$I_{\text{OS}}$	Input Offset Current		0.07	4.3 <b>7.0</b>	$\mu\text{A}$ max
$R_{\text{IN}}$	Input Resistance	Common Mode	6.8		$\text{M}\Omega$
		Differential Mode	3.4		$\text{M}\Omega$

### ±5V DC Electrical Characteristics (Continued)

Unless otherwise specified, all limits guaranteed for  $T_J = 25^\circ\text{C}$ ,  $V^+ = 5\text{V}$ ,  $V^- = -5\text{V}$ ,  $V_{\text{CM}} = V_O = 0\text{V}$  and  $R_L > 1\text{M}\Omega$ . **Bold-face** limits apply at the temperature extremes.

Symbol	Parameter	Conditions	Typ (Note 5)	LM71211 Limit (Note 6)	Units
$C_{\text{IN}}$	Input Capacitance	Common Mode	2.3		pF
CMRR	Common Mode Rejection Ratio	$-2\text{V} \leq V_{\text{CM}} \leq 2\text{V}$	75	65	dB
				<b>60</b>	min
+PSRR	Positive Power Supply Rejection Ratio	$3\text{V} \leq V^+ \leq 5\text{V}$	89	65 <b>60</b>	dB min
-PSRR	Negative Power Supply Rejection Ratio	$-5\text{V} \leq V^- \leq -3\text{V}$	78	65 <b>60</b>	dB min
$V_{\text{CM}}$	Input Common Mode Voltage Range	CMRR $\geq 60\text{ dB}$	3	2.5	V min
			-3	-2.5	V max
$A_V$	Large Signal Voltage Gain	$R_L = 2\text{ k}\Omega$ , $V_O = 3\text{ V}_{\text{PP}}$	66	60 <b>58</b>	dB min
$V_O$	Output Swing	$R_L = 2\text{ k}\Omega$	3.62	3.0 <b>2.75</b>	V min
			-3.62	-3.0 <b>-2.70</b>	V max
		$R_L = 150\Omega$	3.1	2.5 <b>2.3</b>	V min
			-2.8	-2.15 <b>-2.00</b>	V max
$I_{\text{SC}}$	Output Short Circuit Current	Sourcing	53	38 <b>33</b>	mA min
		Sinking	29	21 <b>19</b>	mA min
$I_S$	Supply Current		5.1	6.4 <b>7.2</b>	mA max

### ±5V AC Electrical Characteristics

Unless otherwise specified, all limits guaranteed for  $T_J = 25^\circ\text{C}$ ,  $V^+ = 5\text{V}$ ,  $V^- = -5\text{V}$ ,  $V_{\text{CM}} = V_O = 0\text{V}$  and  $R_L > 1\text{M}\Omega$ . **Bold-face** limits apply at the temperature extremes.

Symbol	Parameter	Conditions	Typ (Note 5)	LM71211 Limit (Note 6)	Units
SR	Slew Rate (Note 8)	$A_V = +2$ , $R_L = 1\text{ k}\Omega$ , $V_O = 6\text{ V}_{\text{PP}}$	520		V/ $\mu\text{s}$
GBW	Unity Gain-Bandwidth	$R_L = 1\text{ k}\Omega$	105		MHz
$\phi_m$	Phase Margin	$R_L = 1\text{ k}\Omega$	74		Deg
f (-3 dB)	Bandwidth (Notes 9, 10)	$R_L = 100\Omega$ , $A_V = +1$	160		MHz
		$R_L = 100\Omega$ , $A_V = +2$	50		
$t_s$	Settling Time	5 $V_{\text{PP}}$ Step, to 0.1%, $R_L = 500\Omega$	65		ns
$t_r$ , $t_f$	Rise and Fall Time (Note 10)	$A_V = +2$ , $R_L = 100\Omega$ , $V_O = 0.4\text{ V}_{\text{PP}}$	5.8		ns
$A_D$	Differential Gain	$A_V = +2$ , $R_L = 150\Omega$	0.3		%

### ±5V AC Electrical Characteristics (Continued)

Unless otherwise specified, all limits guaranteed for  $T_J = 25^\circ\text{C}$ ,  $V^+ = 5\text{V}$ ,  $V^- = -5\text{V}$ ,  $V_{\text{CM}} = V_O = 0\text{V}$  and  $R_L > 1\text{M}\Omega$ . **Bold-face** limits apply at the temperature extremes.

Symbol	Parameter	Conditions	Typ (Note 5)	LM71211 Limit (Note 6)	Units
$\phi_D$	Differential Phase	$A_V = +2$ , $R_L = 150\Omega$	0.65		Deg
$e_n$	Input-Referred Voltage Noise	$f = 10\text{kHz}$	17		$\frac{\text{nV}}{\sqrt{\text{Hz}}}$
$i_n$	Input-Referred Current Noise	$f = 10\text{kHz}$	2		$\frac{\text{pA}}{\sqrt{\text{Hz}}}$
T.H.D.	Total Harmonic Distortion	2 $V_{\text{PP}}$ Output, $R_L = 150\Omega$ , $A_V = +2$ , $f = 1\text{MHz}$	0.1		%
		2 $V_{\text{PP}}$ Output, $R_L = 150\Omega$ , $A_V = +2$ , $f = 5\text{MHz}$	0.6		

### +5V DC Electrical Characteristics

Unless otherwise specified, all limits guaranteed for  $T_J = 25^\circ\text{C}$ ,  $V^+ = +5\text{V}$ ,  $V^- = 0\text{V}$ ,  $V_{\text{CM}} = V_O = V^+/2$  and  $R_L > 1\text{M}\Omega$ . **Bold-face** limits apply at the temperature extremes.

Symbol	Parameter	Conditions	Typ (Note 5)	LM71211 Limit (Note 6)	Units
$V_{\text{OS}}$	Input Offset Voltage		2.4		mV
$I_B$	Input Bias Current		4		$\mu\text{A}$
$I_{\text{OS}}$	Input Offset Current		0.04		$\mu\text{A}$
$R_{\text{IN}}$	Input Resistance	Common Mode	2.6		$\text{M}\Omega$
		Differential Mode	3.4		$\text{M}\Omega$
$C_{\text{IN}}$	Input Capacitance	Common Mode	2.3		pF
CMRR	Common Mode Rejection Ratio	$2\text{V} \leq V_{\text{CM}} \leq 3\text{V}$	65		dB
+PSRR	Positive Power Supply Rejection Ratio	$4.6\text{V} \leq V^+ \leq 5\text{V}$	85		dB
-PSRR	Negative Power Supply Rejection Ratio	$0\text{V} \leq V^- \leq 0.4\text{V}$	61		dB
$V_{\text{CM}}$	Input Common-Mode Voltage Range	CMRR $\geq 45\text{dB}$	3.5		V min
			1.5		V max
$A_V$	Large Signal Voltage Gain	$R_L = 2\text{k}\Omega$ to $V^+/2$	64		dB
$V_O$	Output Swing	$R_L = 2\text{k}\Omega$ to $V^+/2$ , High	3.7		V
		$R_L = 2\text{k}\Omega$ to $V^+/2$ , Low	1.3		
		$R_L = 150\Omega$ to $V^+/2$ , High	3.48		
		$R_L = 150\Omega$ to $V^+/2$ , Low	1.59		
$I_{\text{SC}}$	Output Short Circuit Current	Sourcing	33		mA
		Sinking	20		mA
$I_S$	Supply Current		4.8		mA

## +5V AC Electrical Characteristics

Unless otherwise specified, all limits guaranteed for  $T_J = 25^\circ\text{C}$ ,  $V^+ = +5\text{V}$ ,  $V^- = 0\text{V}$ ,  $V_{\text{CM}} = V_O = V^+/2$  and  $R_L > 1\text{M}\Omega$ . **Bold-face** limits apply at the temperature extremes.

Symbol	Parameter	Conditions	Typ (Note 5)	LM7121I Limit (Note 6)	Units
SR	Slew Rate (Note 8)	$A_V = +2$ , $R_L = 1\text{ k}\Omega$ to $V^+/2$ , $V_O = 1.8 V_{\text{PP}}$	145		V/ $\mu\text{s}$
GBW	Unity Gain-Bandwidth	$R_L = 1\text{ k}\Omega$ to $V^+/2$	80		MHz
$\phi_m$	Phase Margin	$R_L = 1\text{ k}\Omega$ to $V^+/2$	70		Deg
$f$ (-3 dB)	Bandwidth (Notes 9, 10)	$R_L = 100\Omega$ to $V^+/2$ , $A_V = +1$	200		MHz
		$R_L = 100\Omega$ to $V^+/2$ , $A_V = +2$	45		
$t_r$ , $t_f$	Rise and Fall Time (Note 10)	$A_V = +2$ , $R_L = 100\Omega$ , $V_O = 0.2 V_{\text{PP}}$	8		ns
T.H.D.	Total Harmonic Distortion	0.6 $V_{\text{PP}}$ Output, $R_L = 150\Omega$ , $A_V = +2$ , $f = 1\text{ MHz}$	0.067		%
		0.6 $V_{\text{PP}}$ Output, $R_L = 150\Omega$ , $A_V = +2$ , $f = 5\text{ MHz}$	0.33		

**Note 1:** Absolute Maximum Ratings indicate limits beyond which damage to the device may occur. Operating Ratings indicate conditions for which the device is intended to be functional, but specific performance is not guaranteed. For guaranteed specifications and the test conditions, see the Electrical Characteristics.

**Note 2:** Human body model, 1.5 k $\Omega$  in series with 100 pF.

**Note 3:** Applies to both single-supply and split-supply operation. Continuous short circuit operation at elevated ambient temperature can result in exceeding the maximum allowed junction temperature of 150°C.

**Note 4:** The maximum power dissipation is a function of  $T_{\text{J(max)}}$ ,  $\theta_{\text{JA}}$ , and  $T_A$ . The maximum allowable power dissipation at any ambient temperature is  $P_D = (T_{\text{J(max)}} - T_A) / \theta_{\text{JA}}$ . All numbers apply for packages soldered directly into a PC board.

**Note 5:** Typical Values represent the most likely parametric norm.

**Note 6:** All limits are guaranteed by testing or statistical analysis.

**Note 7:** Differential input voltage is measured at  $V_S = \pm 15\text{V}$ .

**Note 8:** Slew rate is the average of the rising and falling slew rates.

**Note 9:** Unity gain operation for  $\pm 5\text{V}$  and  $\pm 15\text{V}$  supplies is with a feedback network of 510 $\Omega$  and 3 pF in parallel (see the Application Information section). For +5V single supply operation, feedback is a direct short from the output to the inverting input.

**Note 10:**  $A_V = +2$  operation with 2 k $\Omega$  resistors and 2 pF capacitor from summing node to ground.

## Typical Performance Characteristics $T_A = 25^\circ\text{C}$ , $R_L = 1\text{M}\Omega$ . unless otherwise specified

Supply Current vs Supply Voltage

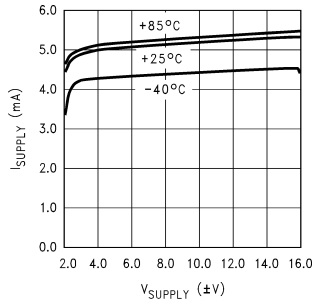

Supply Current vs Temperature

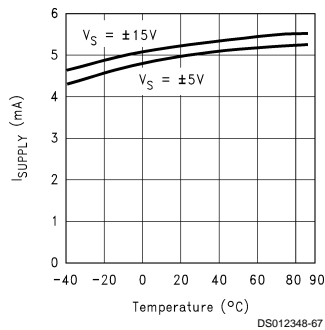

Input Offset Voltage vs Temperature

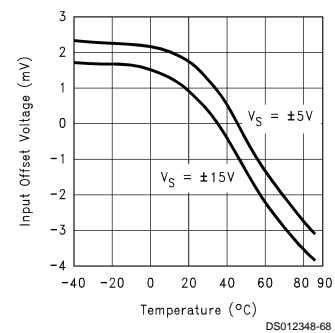

**Typical Performance Characteristics**  $T_A = 25^\circ\text{C}$ ,  $R_L = 1\text{ M}\Omega$ , unless otherwise specified (Continued)

**Input Bias Current vs Temperature**

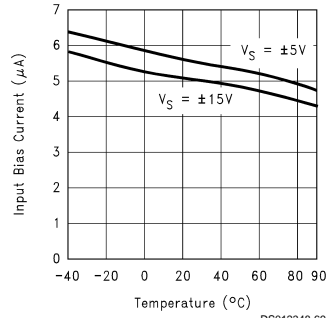

**Input Offset Voltage vs Common Mode Voltage @  $V_S = \pm 15\text{V}$**

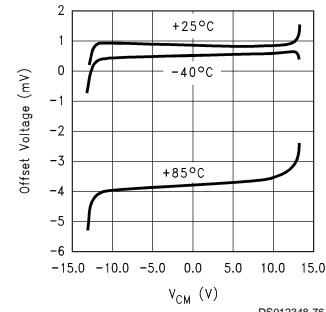

**Input Offset Voltage vs Common Mode Voltage @  $V_S = \pm 5\text{V}$**

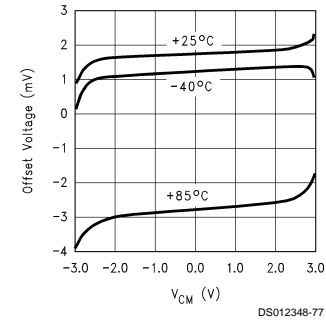

**Short Circuit Current vs Temperature (Sourcing)**

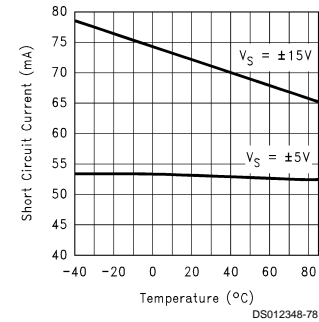

**Short Circuit Current vs Temperature (Sinking)**

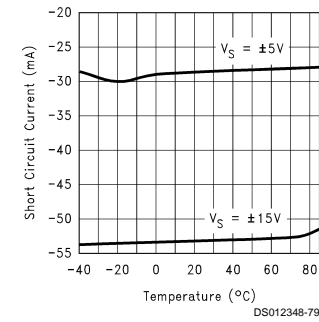

**Output Voltage vs Output Current ( $I_{\text{SINK}}$ ,  $V_S = \pm 15\text{V}$ )**

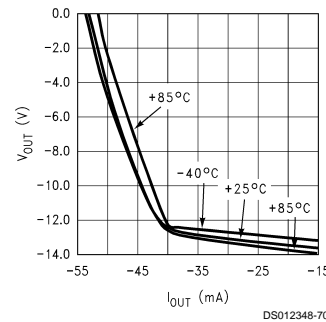

**Output Voltage vs Output Current ( $I_{\text{SOURCE}}$ ,  $V_S = \pm 15\text{V}$ )**

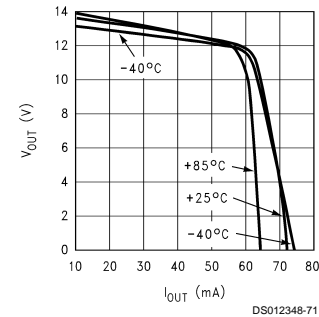

**Output Voltage vs Output Current ( $I_{\text{SOURCE}}$ ,  $V_S = \pm 5\text{V}$ )**

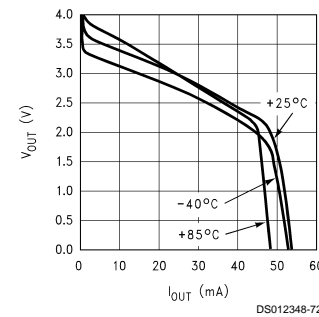

**Output Voltage vs Output Current ( $I_{\text{SINK}}$ ,  $V_S = \pm 5\text{V}$ )**

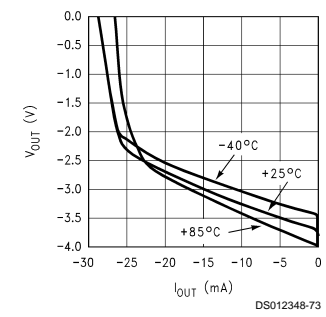



**Typical Performance Characteristics**  $T_A = 25^\circ\text{C}$ ,  $R_L = 1\text{ M}\Omega$ , unless otherwise specified (Continued)

**Output Voltage vs Output Current ( $I_{\text{SOURCE}}$ ,  $V_S = +5\text{V}$ )**

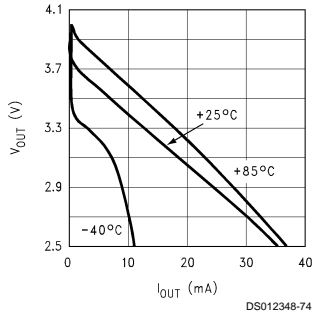

**Output Voltage vs Output Current ( $I_{\text{SINK}}$ ,  $V_S = +5\text{V}$ )**

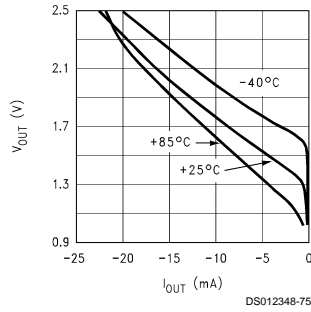

**CMRR vs Frequency**

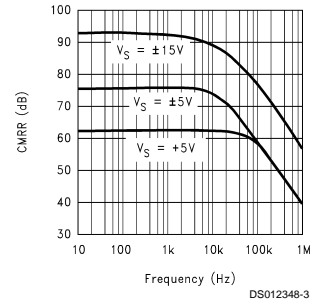

**PSRR vs Frequency**

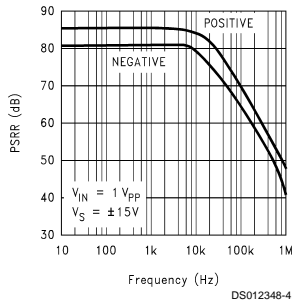

**PSRR vs Frequency**

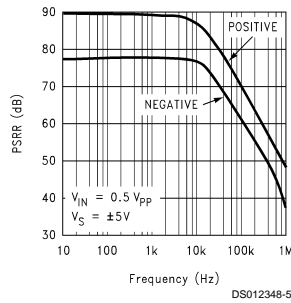

**Open Loop Frequency Response**

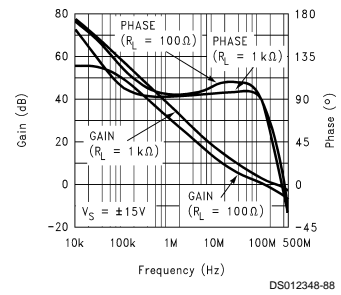

**Open Loop Frequency Response**

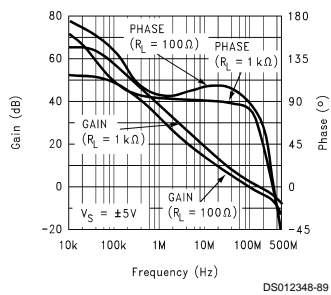

**Open Loop Frequency Response**

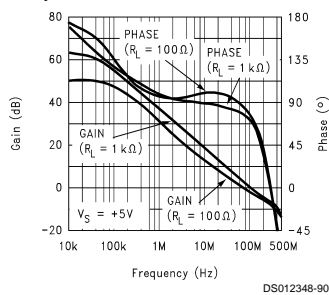

**Unity Gain Frequency vs Supply Voltage**

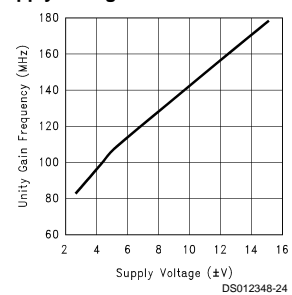

**Typical Performance Characteristics**  $T_A = 25^\circ\text{C}$ ,  $R_L = 1\text{ M}\Omega$ . unless otherwise specified (Continued)

**GBWP @ 10 MHz vs Supply Voltage**

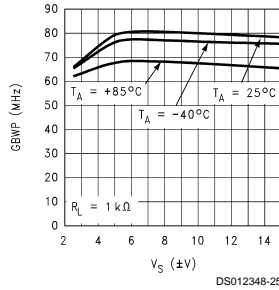

**Large Signal Voltage Gain vs Load,  $V_S = \pm 15\text{V}$**

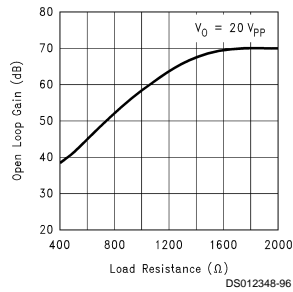

**Large Signal Voltage Gain vs Load,  $V_S = \pm 5\text{V}$**

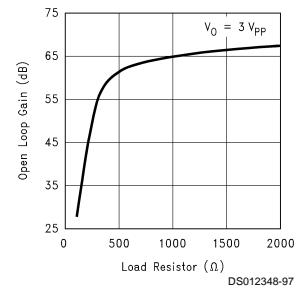

**Input Voltage Noise vs Frequency**

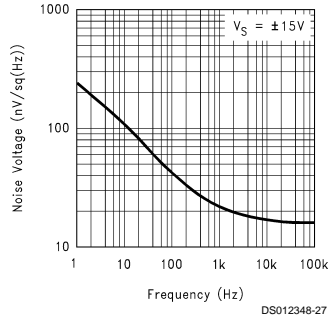

**Input Current Noise vs Frequency**

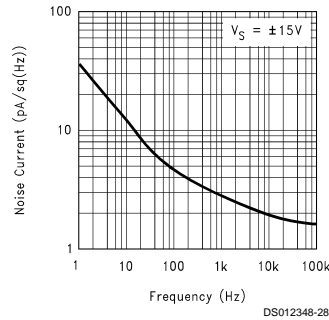

**Input Voltage Noise vs Frequency**

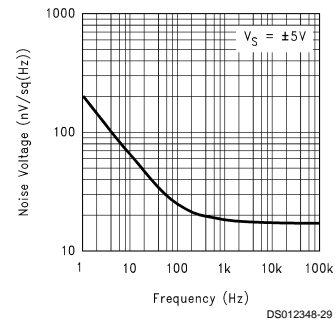

**Input Current Noise vs Frequency**

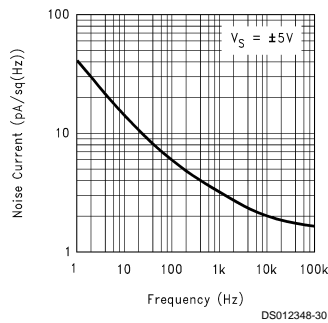

**Slew Rate vs Supply Voltage**

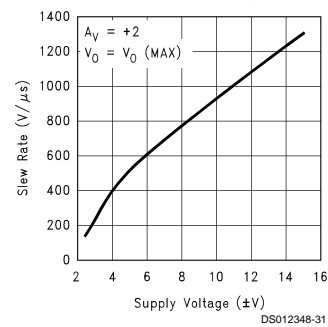

**Slew Rate vs Input Voltage**

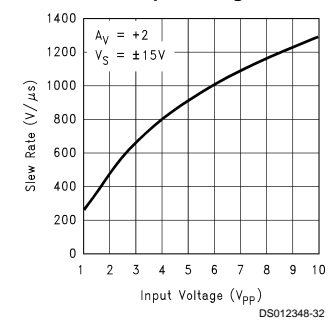

**Typical Performance Characteristics**  $T_A = 25^\circ\text{C}$ ,  $R_L = 1\text{ M}\Omega$ . unless otherwise specified (Continued)

**Slew Rate vs Input Voltage**

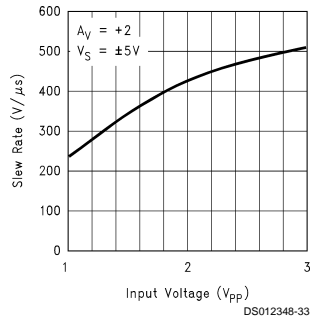

**Slew Rate vs Load Capacitance**

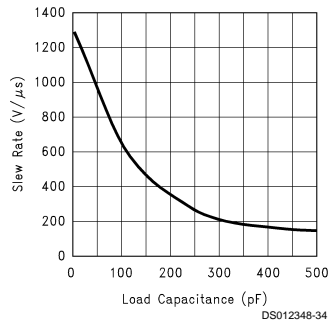

**Large Signal Pulse Response,  $A_V = -1$ ,  $V_S = \pm 15\text{V}$**

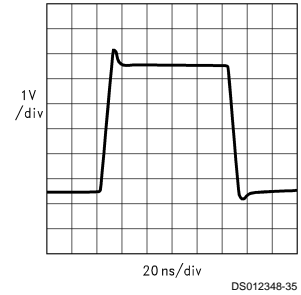

**Large Signal Pulse Response,  $A_V = -1$ ,  $V_S = \pm 5\text{V}$**

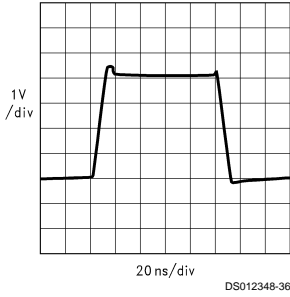

**Large Signal Pulse Response,  $A_V = -1$ ,  $V_S = +5\text{V}$**

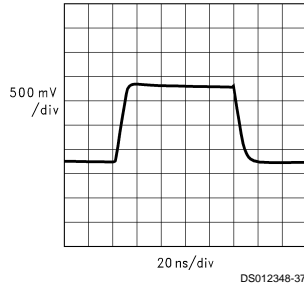

**Large Signal Pulse Response,  $A_V = +1$ ,  $V_S = \pm 15\text{V}$**

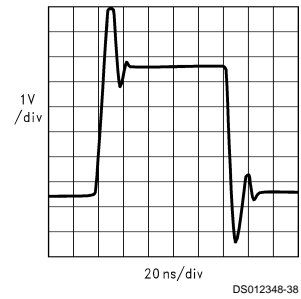

**Large Signal Pulse Response,  $A_V = +1$ ,  $V_S = \pm 5\text{V}$**

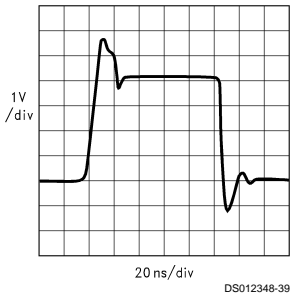

**Large Signal Pulse Response,  $A_V = +1$ ,  $V_S = +5\text{V}$**

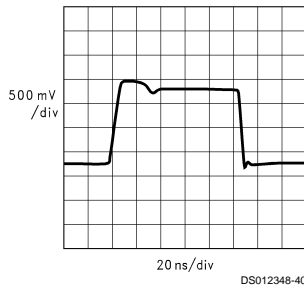

**Large Signal Pulse Response,  $A_V = +2$ ,  $V_S = \pm 15\text{V}$**

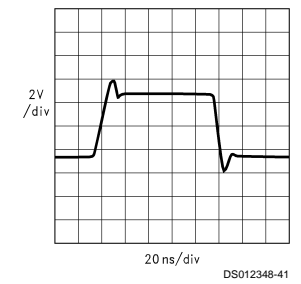

**Typical Performance Characteristics**  $T_A = 25^\circ\text{C}$ ,  $R_L = 1\text{ M}\Omega$ . unless otherwise specified (Continued)

**Large Signal Pulse Response,**  
 $A_V = +2$ ,  $V_S = \pm 5\text{V}$

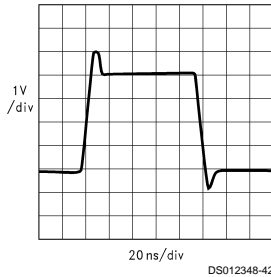

**Large Signal Pulse Response,**  
 $A_V = +2$ ,  $V_S = +5\text{V}$

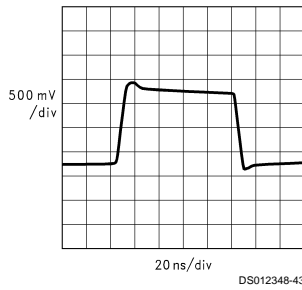

**Small Signal Pulse Response,**  
 $A_V = -1$ ,  $V_S = \pm 15\text{V}$ ,  $R_L = 100\Omega$

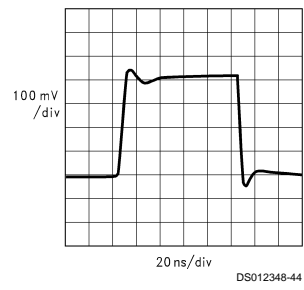

**Small Signal Pulse Response,**  
 $A_V = -1$ ,  $V_S = \pm 5\text{V}$ ,  
 $R_L = 100\Omega$

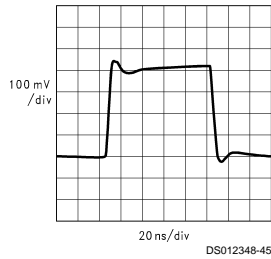

**Small Signal Pulse Response,**  
 $A_V = -1$ ,  $V_S = +5\text{V}$ ,  
 $R_L = 100\Omega$

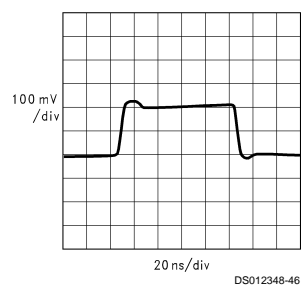

**Small Signal Pulse Response,**  
 $A_V = +1$ ,  $V_S = \pm 15\text{V}$ ,  
 $R_L = 100\Omega$

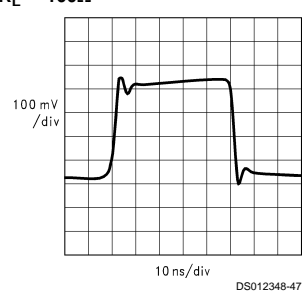

**Small Signal Pulse Response,**  
 $A_V = +1$ ,  $V_S = \pm 5\text{V}$ ,  
 $R_L = 100\Omega$

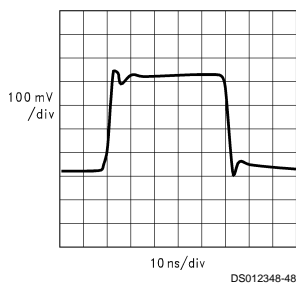

**Small Signal Pulse Response,**  
 $A_V = +1$ ,  $V_S = +5\text{V}$ ,  
 $R_L = 100\Omega$

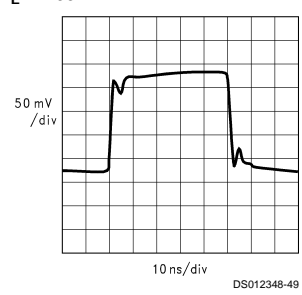

**Small Signal Pulse Response,**  
 $A_V = +2$ ,  $V_S = \pm 15\text{V}$ ,  
 $R_L = 100\Omega$

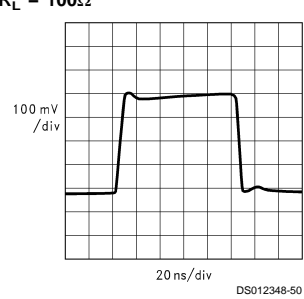

**Typical Performance Characteristics**  $T_A = 25^\circ\text{C}$ ,  $R_L = 1\text{ M}\Omega$ . unless otherwise specified (Continued)

**Small Signal Pulse Response,**  
 $A_V = +2$ ,  $V_S = \pm 5\text{V}$ ,  
 $R_L = 100\Omega$

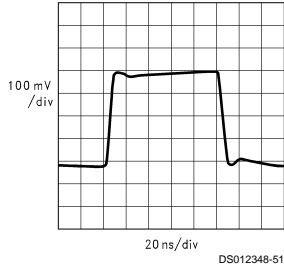

**Small Signal Pulse Response,**  
 $A_V = +2$ ,  $V_S = +5\text{V}$ ,  
 $R_L = 100\Omega$

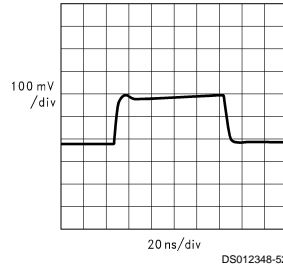

**Closed Loop Frequency Response vs Temperature**  
 $V_S = \pm 15\text{V}$ ,  $A_V = +1$ ,  $R_L = 100\Omega$

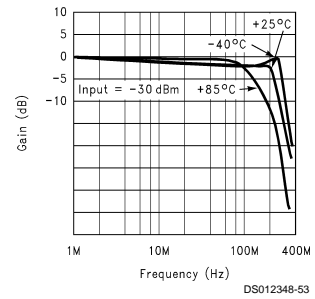

**Closed Loop Frequency Response vs Temperature**  
 $V_S = \pm 5\text{V}$ ,  $A_V = +1$ ,  $R_L = 100\Omega$

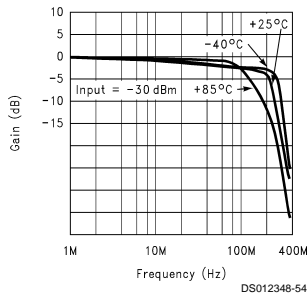

**Closed Loop Frequency Response vs Temperature**  
 $V_S = +5\text{V}$ ,  $A_V = +1$ ,  $R_L = 100\Omega$

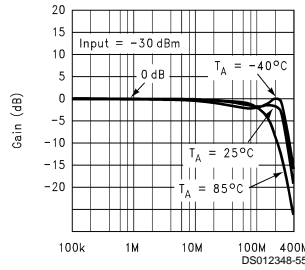

**Closed Loop Frequency Response vs Temperature**  
 $V_S = \pm 15\text{V}$ ,  $A_V = +2$ ,  $R_L = 100\Omega$

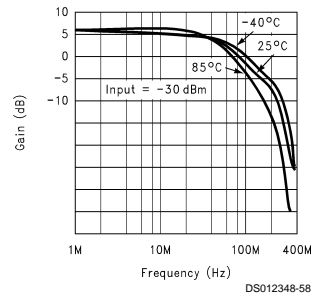

**Closed Loop Frequency Response vs Temperature**  
 $V_S = \pm 5\text{V}$ ,  $A_V = +2$ ,  $R_L = 100\Omega$

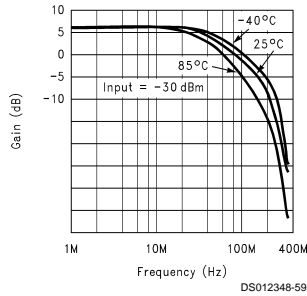

**Closed Loop Frequency Response vs Temperature**  
 $V_S = +5\text{V}$ ,  $A_V = +2$ ,  $R_L = 100\Omega$

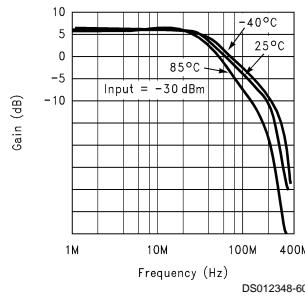

**Closed Loop Frequency Response vs Capacitive Load**  
 $A_V = +1$ ,  $V_S = \pm 15\text{V}$

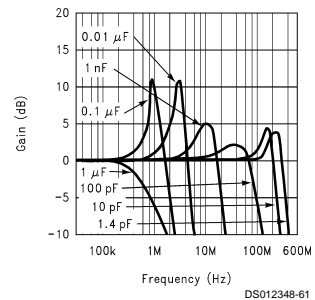

**Typical Performance Characteristics**  $T_A = 25^\circ\text{C}$ ,  $R_L = 1\text{ M}\Omega$ . unless otherwise specified (Continued)

**Closed Loop Frequency Response vs Capacitive Load ( $A_V = +1$ ,  $V_S = \pm 5\text{V}$ )**

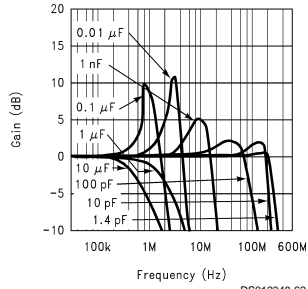

DS012348-62

**Closed Loop Frequency Response vs Capacitive Load ( $A_V = +2$ ,  $V_S = \pm 15\text{V}$ )**

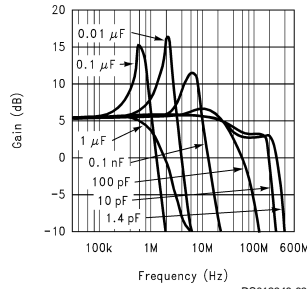

DS012348-63

**Closed Loop Frequency Response vs Capacitive Load ( $A_V = +2$ ,  $V_S = \pm 5\text{V}$ )**

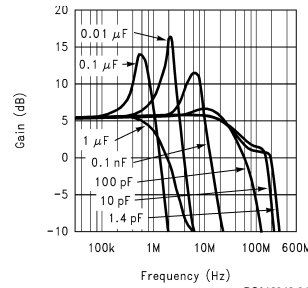

DS012348-64

**Total Harmonic Distortion vs Frequency**

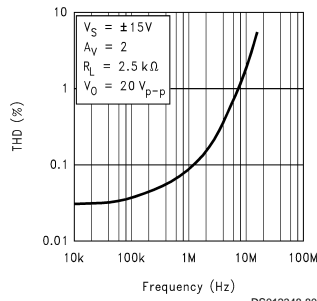

DS012348-80

**Total Harmonic Distortion vs Frequency**

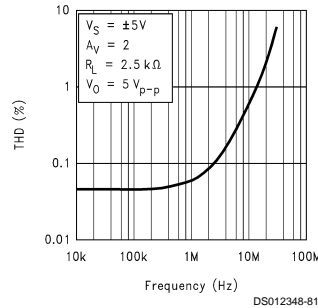

DS012348-81

**Total Harmonic Distortion vs Frequency**

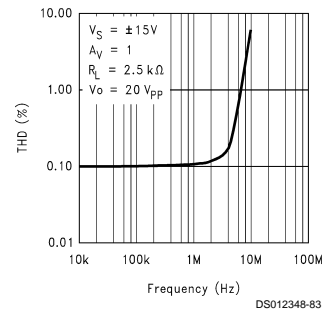

DS012348-83

**Total Harmonic Distortion vs Frequency**

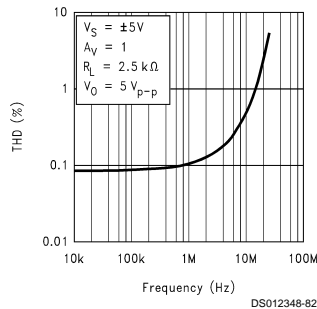

DS012348-82

**Undistorted Output Swing vs Frequency**

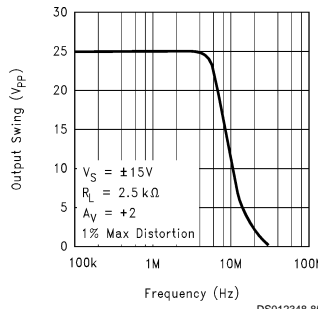

DS012348-85

**Undistorted Output Swing vs Frequency**

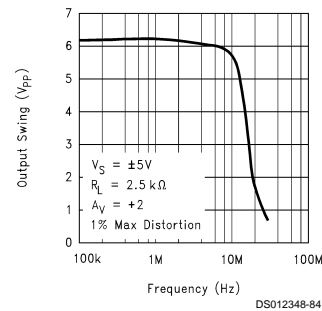

DS012348-84

## Typical Performance Characteristics $T_A = 25^\circ\text{C}$ , $R_L = 1\text{ M}\Omega$ . unless otherwise specified (Continued)

### Undistorted Output Swing vs Frequency

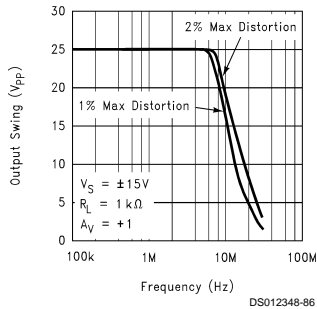

### Total Power Dissipation vs Ambient Temperature

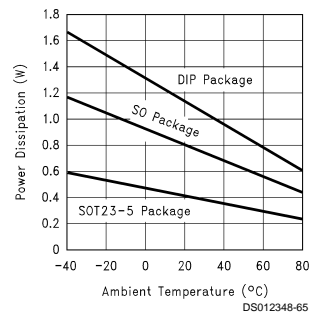

## Application Information

The table below, depicts the maximum operating supply voltage for each package type:

TABLE 1. Maximum Supply Voltage Values

	SOT23-5	SO-8
Single Supply	10V	30V
Dual Supplies	±5V	±15V

Stable unity gain operation is possible with supply voltage of 5V for all capacitive loads. This allows the possibility of using the device in portable applications with low supply voltages with minimum components around it.

Above a supply voltage of 6V ( $\pm 3\text{V}$  Dual supplies), an additional resistor and capacitor (shown below) should be placed in the feedback path to achieve stability at unity gain over the full temperature range.

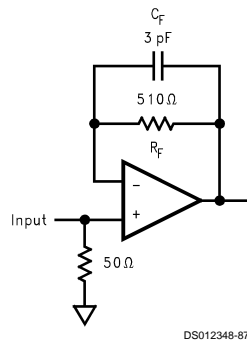

FIGURE 1. Typical Circuit for  $A_V = +1$  Operation ( $V_S \geq 6\text{V}$ )

The package power dissipation should be taken into account when operating at high ambient temperatures and/or high power dissipative conditions. Refer to the power derating curves in the data sheet for each type of package.

In determining maximum operable temperature of the device, make sure the total power dissipation of the device is considered; this includes the power dissipated in the device with a load connected to the output as well as the nominal dissipation of the op amp.

The device is capable of tolerating momentary short circuits from its output to ground but prolonged operation in this mode will damage the device, if the maximum allowed junction temperature is exceeded.

### APPLICATION CIRCUITS

#### Current Boost Circuit

The circuit in Figure 2 can be used to achieve good linearity along with high output current capability.

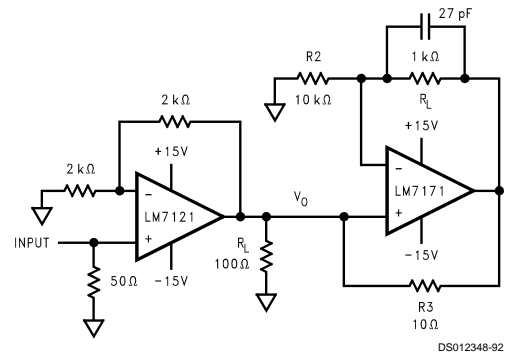

FIGURE 2. Simple Circuit to Improve Linearity and Output Drive Current

By proper choice of  $R_3$ , the LM7121 output can be set to supply a minimal amount of current, thereby improving its output linearity.

$R_3$  can be adjusted to allow for different loads:

$$R_3 = 0.1 R_L$$

The circuit above has been set for a load of  $100\Omega$ .

Reasonable speeds ( $< 30\text{ ns}$  rise and fall times) can be expected up to  $120\text{ mA}_{PP}$  of load current (see Figure 3 for step response across the load).

## Application Information (Continued)

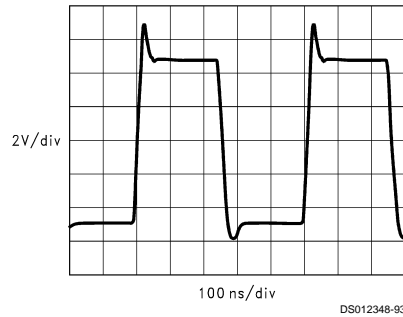

**FIGURE 3. Waveform across a 100Ω Load**

It is very important to keep the lead lengths to a minimum and to provide a low impedance current path by using a ground-plane on the board.

**Caution:** If  $R_L$  is removed, the current balance at the output of LM7121 would be disturbed and it would have to supply the full amount of load current. This might damage the part if power dissipation limit is exceeded.

### Color Video on Twisted Pairs Using Single Supply

The circuit shown in *Figure 4* can be used to drive in excess of 25 meters length of twisted pair cable with no loss of resolution or picture definition when driving a NTSC monitor at the load end.



## Application Information (Continued)

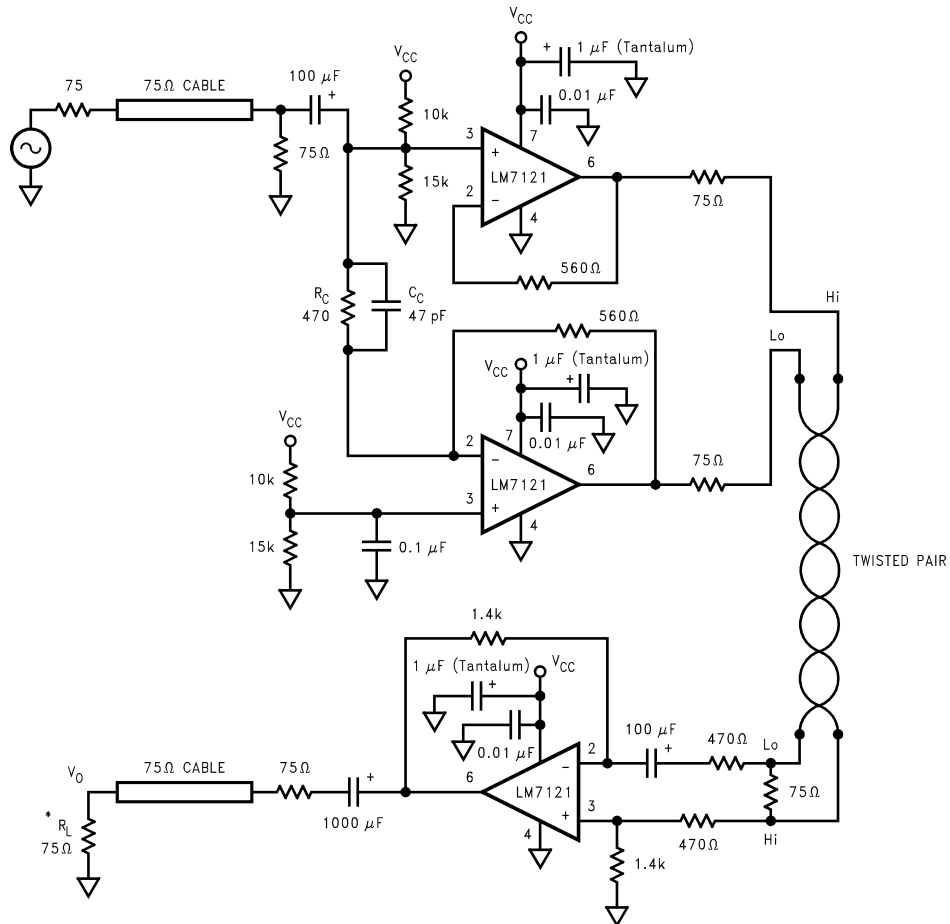

DS012348-94

**Note:**  
Pin numbers shown are for SO-8 package.  
\*Input termination of NTSC monitor.

**FIGURE 4. Single Supply Differential Twisted Pair Cable Transmitter/Receiver**  
 $8.5V \leq V_{CC} \leq 30V$

Differential Gain and Differential Phase errors measured at the load are less than 1% and  $1^\circ$  respectively.

$R_C$  and  $C_C$  can be adjusted for various cable lengths to compensate for the line losses and for proper response at the output. Values shown correspond to a twisted pair cable length of 25 meters with about 3 turns/inch (see Figure 5 for step response).

The supply voltage can vary from 8.5V up to 30V with the output rise and fall times under 12 ns. With the component values shown, the overall gain from the input to the output is about 1.

Even though the transmission line is not terminated in its nominal characteristic impedance of about  $600\Omega$ , the resulting reflection at the load is only about 5% of the total signal and in most cases can be neglected. Using  $75\Omega$  termination instead, has the advantage of operating at a low impedance and results in a higher realizable bandwidth and signal fidelity.

## Application Information (Continued)

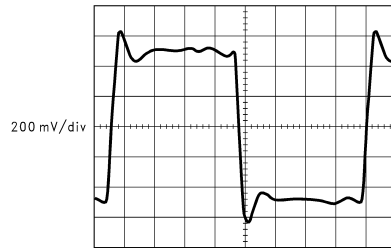

DS012348-95

**FIGURE 5. Step Response to a 1 V<sub>PP</sub> Input Signal Measured across the 75Ω Load**

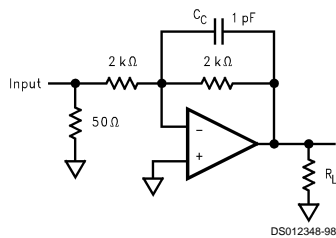

DS012348-98

**(a)  $A_V = -1$**

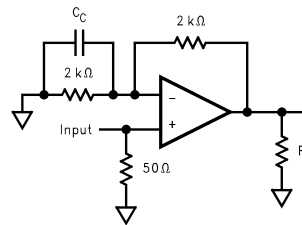

DS012348-99

**(b)  $A_V = +2$**

$C_C = 2 \text{ pF}$  for  $R_L = 100\Omega$   
 $C_C = \text{Open}$  for  $R_L = \text{Open}$

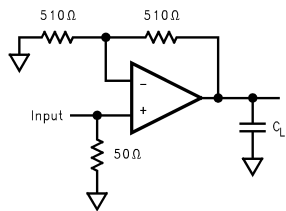

DS012348-A0

**(c)  $A_V = +2$ , Capacitive Load**

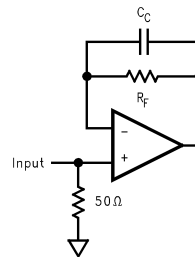

DS012348-A1

**(d)  $A_V = +1$**

$R_F = 0\Omega$ ,  $C_C = \text{Open}$  for  $V_S < 6V$   
 $R_F = 510\Omega$ ,  $C_C = 3 \text{ pF}$  for  $V_S \geq 6V$

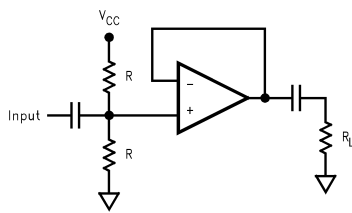

DS012348-A2

**(e)  $A_V = +1$ ,  $V_S = +5V$ , Single Supply Operation**

**FIGURE 6. Application Test Circuits**

**Physical Dimensions** inches (millimeters) unless otherwise noted

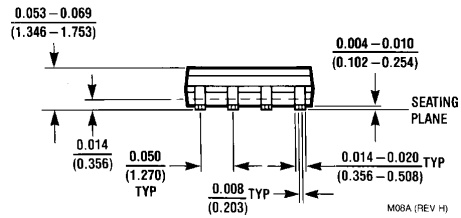
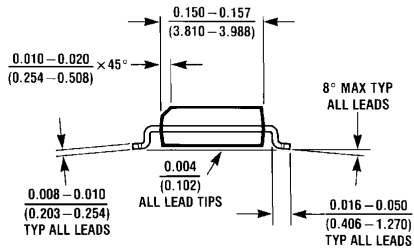
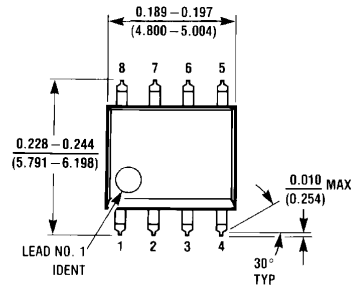

**8-Lead (0.150" Wide) Small Outline Package, JEDEC**  
**Order Number LM7121IM or LM7121IMX**  
**NS Package Number M08A**

**Physical Dimensions** inches (millimeters) unless otherwise noted (Continued)

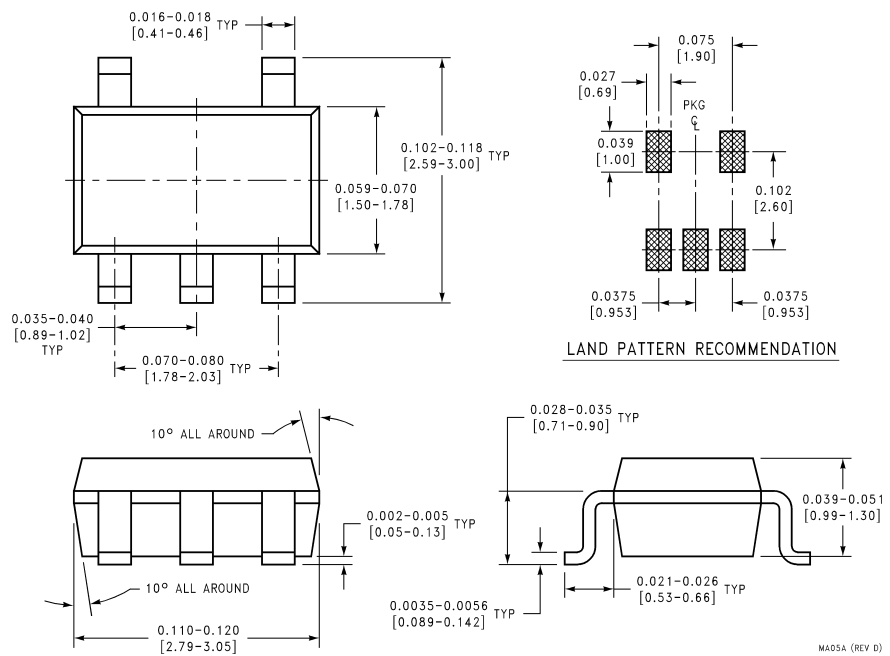

**5-Lead Molded SOT23-5**  
**Order Number LM7121IM5 or LM7121IM5X**  
**NS Package Number MA05A**

**LIFE SUPPORT POLICY**

NATIONAL'S PRODUCTS ARE NOT AUTHORIZED FOR USE AS CRITICAL COMPONENTS IN LIFE SUPPORT DEVICES OR SYSTEMS WITHOUT THE EXPRESS WRITTEN APPROVAL OF THE PRESIDENT AND GENERAL COUNSEL OF NATIONAL SEMICONDUCTOR CORPORATION. As used herein:

1. Life support devices or systems are devices or systems which, (a) are intended for surgical implant into the body, or (b) support or sustain life, and whose failure to perform when properly used in accordance with instructions for use provided in the labeling, can be reasonably expected to result in a significant injury to the user.
2. A critical component is any component of a life support device or system whose failure to perform can be reasonably expected to cause the failure of the life support device or system, or to affect its safety or effectiveness.

 <p><b>National Semiconductor Corporation</b>  Americas  Tel: 1-800-272-9959  Fax: 1-800-737-7018  Email: support@nsc.com  www.national.com</p>	<p><b>National Semiconductor Europe</b>  Fax: +49 (0) 1 80-530 85 86  Email: europe.support@nsc.com  Deutsch Tel: +49 (0) 1 80-530 85 85  English Tel: +49 (0) 1 80-532 78 32  Français Tel: +49 (0) 1 80-532 93 58  Italiano Tel: +49 (0) 1 80-534 16 80</p>	<p><b>National Semiconductor Asia Pacific Customer Response Group</b>  Tel: 65-2544466  Fax: 65-2504466  Email: sea.support@nsc.com</p>	<p><b>National Semiconductor Japan Ltd.</b>  Tel: 81-3-5639-7560  Fax: 81-3-5639-7507</p>
--	---	---	---

National does not assume any responsibility for use of any circuitry described, no circuit patent licenses are implied and National reserves the right at any time without notice to change said circuitry and specifications.

## IMPORTANT NOTICE

Texas Instruments Incorporated and its subsidiaries (TI) reserve the right to make corrections, modifications, enhancements, improvements, and other changes to its products and services at any time and to discontinue any product or service without notice. Customers should obtain the latest relevant information before placing orders and should verify that such information is current and complete. All products are sold subject to TI's terms and conditions of sale supplied at the time of order acknowledgment.

TI warrants performance of its hardware products to the specifications applicable at the time of sale in accordance with TI's standard warranty. Testing and other quality control techniques are used to the extent TI deems necessary to support this warranty. Except where mandated by government requirements, testing of all parameters of each product is not necessarily performed.

TI assumes no liability for applications assistance or customer product design. Customers are responsible for their products and applications using TI components. To minimize the risks associated with customer products and applications, customers should provide adequate design and operating safeguards.

TI does not warrant or represent that any license, either express or implied, is granted under any TI patent right, copyright, mask work right, or other TI intellectual property right relating to any combination, machine, or process in which TI products or services are used. Information published by TI regarding third-party products or services does not constitute a license from TI to use such products or services or a warranty or endorsement thereof. Use of such information may require a license from a third party under the patents or other intellectual property of the third party, or a license from TI under the patents or other intellectual property of TI.

Reproduction of TI information in TI data books or data sheets is permissible only if reproduction is without alteration and is accompanied by all associated warranties, conditions, limitations, and notices. Reproduction of this information with alteration is an unfair and deceptive business practice. TI is not responsible or liable for such altered documentation. Information of third parties may be subject to additional restrictions.

Resale of TI products or services with statements different from or beyond the parameters stated by TI for that product or service voids all express and any implied warranties for the associated TI product or service and is an unfair and deceptive business practice. TI is not responsible or liable for any such statements.

TI products are not authorized for use in safety-critical applications (such as life support) where a failure of the TI product would reasonably be expected to cause severe personal injury or death, unless officers of the parties have executed an agreement specifically governing such use. Buyers represent that they have all necessary expertise in the safety and regulatory ramifications of their applications, and acknowledge and agree that they are solely responsible for all legal, regulatory and safety-related requirements concerning their products and any use of TI products in such safety-critical applications, notwithstanding any applications-related information or support that may be provided by TI. Further, Buyers must fully indemnify TI and its representatives against any damages arising out of the use of TI products in such safety-critical applications.

TI products are neither designed nor intended for use in military/aerospace applications or environments unless the TI products are specifically designated by TI as military-grade or "enhanced plastic." Only products designated by TI as military-grade meet military specifications. Buyers acknowledge and agree that any such use of TI products which TI has not designated as military-grade is solely at the Buyer's risk, and that they are solely responsible for compliance with all legal and regulatory requirements in connection with such use.

TI products are neither designed nor intended for use in automotive applications or environments unless the specific TI products are designated by TI as compliant with ISO/TS 16949 requirements. Buyers acknowledge and agree that, if they use any non-designated products in automotive applications, TI will not be responsible for any failure to meet such requirements.

Following are URLs where you can obtain information on other Texas Instruments products and application solutions:

### Products

Audio	<a href="http://www.ti.com/audio">www.ti.com/audio</a>
Amplifiers	<a href="http://amplifier.ti.com">amplifier.ti.com</a>
Data Converters	<a href="http://dataconverter.ti.com">dataconverter.ti.com</a>
DLP® Products	<a href="http://www.dlp.com">www.dlp.com</a>
DSP	<a href="http://dsp.ti.com">dsp.ti.com</a>
Clocks and Timers	<a href="http://www.ti.com/clocks">www.ti.com/clocks</a>
Interface	<a href="http://interface.ti.com">interface.ti.com</a>
Logic	<a href="http://logic.ti.com">logic.ti.com</a>
Power Mgmt	<a href="http://power.ti.com">power.ti.com</a>
Microcontrollers	<a href="http://microcontroller.ti.com">microcontroller.ti.com</a>
RFID	<a href="http://www.ti-rfid.com">www.ti-rfid.com</a>
OMAP Mobile Processors	<a href="http://www.ti.com/omap">www.ti.com/omap</a>
Wireless Connectivity	<a href="http://www.ti.com/wirelessconnectivity">www.ti.com/wirelessconnectivity</a>

### Applications

Communications and Telecom	<a href="http://www.ti.com/communications">www.ti.com/communications</a>
Computers and Peripherals	<a href="http://www.ti.com/computers">www.ti.com/computers</a>
Consumer Electronics	<a href="http://www.ti.com/consumer-apps">www.ti.com/consumer-apps</a>
Energy and Lighting	<a href="http://www.ti.com/energy">www.ti.com/energy</a>
Industrial	<a href="http://www.ti.com/industrial">www.ti.com/industrial</a>
Medical	<a href="http://www.ti.com/medical">www.ti.com/medical</a>
Security	<a href="http://www.ti.com/security">www.ti.com/security</a>
Space, Avionics and Defense	<a href="http://www.ti.com/space-avionics-defense">www.ti.com/space-avionics-defense</a>
Transportation and Automotive	<a href="http://www.ti.com/automotive">www.ti.com/automotive</a>
Video and Imaging	<a href="http://www.ti.com/video">www.ti.com/video</a>

TI E2E Community Home Page

[e2e.ti.com](http://e2e.ti.com)

Mailing Address: Texas Instruments, Post Office Box 655303, Dallas, Texas 75265  
Copyright © 2011, Texas Instruments Incorporated