

## LM7171QML Very High Speed, High Output Current, Voltage Feedback Amplifier

 Check for Samples: [LM7171QML](#), [LM7171QML-SP](#)

### FEATURES

- (Typical Unless Otherwise Noted)
- Easy-To-Use Voltage Feedback Topology
- Very High Slew Rate: 2400V/μs
- Wide Unity-Gain Bandwidth: 200 MHz
- -3 dB Frequency @  $A_V = +2$ : 220 MHz
- Low Supply Current: 6.5 mA
- High Open Loop Gain: 85 dB
- High Output Current: 100 mA
- Specified for ±15V and ±5V Operation
- Available with Radiation Guarantee
  - Total Ionizing Dose 300 Krad(Si)
  - ELDRS Free 300 Krad(Si)

### APPLICATIONS

- HDSL and ADSL Drivers
- Multimedia Broadcast Systems
- Professional Video Cameras
- Video Amplifiers
- Copiers/Scanners/Fax
- HDTV Amplifiers
- Pulse Amplifiers and Peak Detectors
- CATV/Fiber Optics Signal Processing

### Connection Diagram

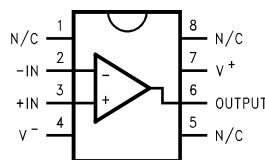

Figure 1. 8-Pin CDIP Top View

### DESCRIPTION

The LM7171 is a high speed voltage feedback amplifier that has the slewing characteristic of a current feedback amplifier; yet it can be used in all traditional voltage feedback amplifier configurations. The LM7171 is stable for gains as low as +2 or -1. It provides a very high slew rate at 4100V/μs and a wide unity-gain bandwidth of 200 MHz while consuming only 6.5 mA of supply current. It is ideal for video and high speed signal processing applications such as HDSL and pulse amplifiers. With 100 mA output current, the LM7171 can be used for video distribution, as a transformer driver or as a laser diode driver.

Operation on ±15V power supplies allows for large signal swings and provides greater dynamic range and signal-to-noise ratio. The LM7171 offers low SFDR and THD, ideal for ADC/DAC systems. In addition, the LM7171 is specified for ±5V operation for portable applications.

The LM7171 is built on Texas Instruments's advanced VIP™ III (Vertically integrated PNP) complementary bipolar process.

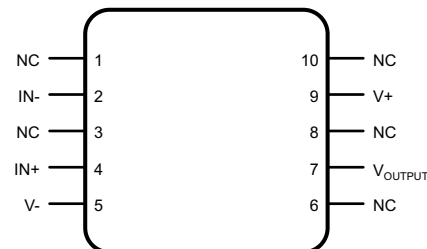

Figure 2. 10-Pin CFP Top View



Please be aware that an important notice concerning availability, standard warranty, and use in critical applications of Texas Instruments semiconductor products and disclaimers thereto appears at the end of this data sheet.

VIP is a trademark of Texas Instruments.

All other trademarks are the property of their respective owners.

**Simplified Schematic Diagram**

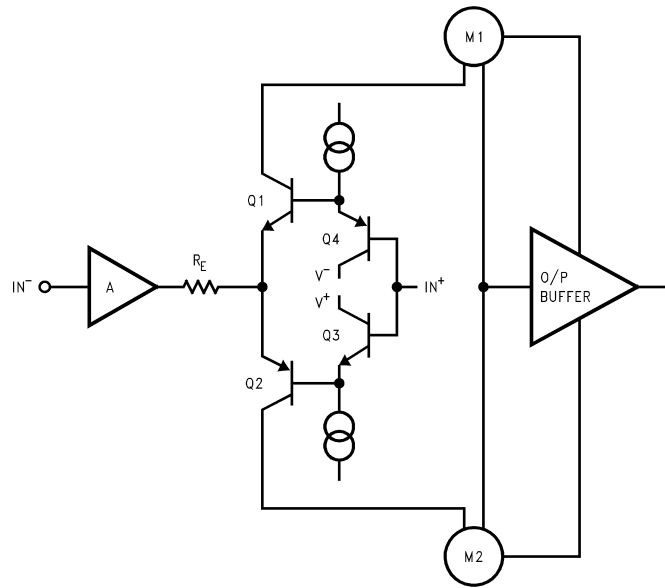

**Note:** M1 and M2 are current mirrors.

**Typical Performance**  
**Large Signal Pulse Response**  
 $A_V = +2, V_S = \pm 15V$

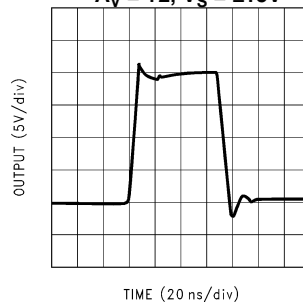

These devices have limited built-in ESD protection. The leads should be shorted together or the device placed in conductive foam during storage or handling to prevent electrostatic damage to the MOS gates.

### Absolute Maximum Ratings<sup>(1)</sup>

Supply Voltage ( $V^+ - V^-$ )		36V	
Differential Input Voltage <sup>(2)</sup>		$\pm 10V$	
Maximum Power Dissipation <sup>(3)</sup>		730mW	
Output Short Circuit to Ground <sup>(4)</sup>		Continuous	
Storage Temperature Range		$-65^\circ\text{C} \leq T_A \leq +150^\circ\text{C}$	
Thermal Resistance <sup>(5)</sup>	$\theta_{JA}$	8LD CDIP (Still Air)	106°C/W
		8LD CDIP (500LF/Min Air flow)	53°C/W
		10LD CFP (Still Air)	182°C/W
		10LD CFP (500LF/Min Air flow)	105°C/W
		10LD CFP "WG" (device 01, 02) (Still Air)	182°C/W
		10LD CFP "WG" (device 01, 02) (500LF/Min Air flow)	105°C/W
	$\theta_{JC}$	8LD CDIP	3°C/W
		10LD CFP	5°C/W
		10LD CFP "WG" (device 01, 02) <sup>(6)</sup>	5°C/W
Package Weight (Typical)	8LD CDIP	965mg	
	10LD CFP	235mg	
	10LD CFP "WG" (device 01, 02)	230mg	
Maximum Junction Temperature <sup>(3)</sup>		150°C	
ESD Tolerance <sup>(7)</sup>		3000V	

- (1) Absolute Maximum Ratings indicate limits beyond which damage to the device may occur. Operating Ratings indicate conditions for which the device is functional, but do not guarantee specific performance limits. For specified specifications and test conditions, see the Electrical Characteristics. The specified specifications apply only for the test conditions listed. Some performance characteristics may degrade when the device is not operated under the listed test conditions.
- (2) Differential input voltage is applied at  $V_S = \pm 15V$ .
- (3) The maximum power dissipation must be derated at elevated temperatures and is dictated by  $T_{Jmax}$  (maximum junction temperature),  $\theta_{JA}$  (package junction to ambient thermal resistance), and  $T_A$  (ambient temperature). The maximum allowable power dissipation at any temperature is  $P_{Dmax} = (T_{Jmax} - T_A)/\theta_{JA}$  or the number given in the Absolute Maximum Ratings, whichever is lower.
- (4) Applies to both single-supply and split-supply operation. Continuous short circuit operation at elevated ambient temperature can result in exceeding the maximum allowed junction temperature of 150°C.
- (5) All numbers apply for packages soldered directly into a PC board.
- (6) The package material for these devices allows much improved heat transfer over our standard ceramic packages. In order to take full advantage of this improved heat transfer, heat sinking must be provided between the package base (directly beneath the die), and either metal traces on, or thermal vias through, the printed circuit board. Without this additional heat sinking, device power dissipation must be calculated using  $\theta_{JA}$ , rather than  $\theta_{JC}$ , thermal resistance. It must not be assumed that the device leads will provide substantial heat transfer out the package, since the thermal resistance of the leadframe material is very poor, relative to the material of the package base. The stated  $\theta_{JC}$  thermal resistance is for the package material only, and does not account for the additional thermal resistance between the package base and the printed circuit board. The user must determine the value of the additional thermal resistance and must combine this with the stated value for the package, to calculate the total allowed power dissipation for the device.
- (7) Human body model, 1.5 k $\Omega$  in series with 100 pF.

### Recommended Operating Conditions<sup>(1)</sup>

Supply Voltage	$5.5V \leq V_S \leq 36V$
Operating Temperature Range	$-55^\circ\text{C} \leq T_A \leq +125^\circ\text{C}$

- (1) Absolute Maximum Ratings indicate limits beyond which damage to the device may occur. Operating Ratings indicate conditions for which the device is functional, but do not guarantee specific performance limits. For specified specifications and test conditions, see the Electrical Characteristics. The specified specifications apply only for the test conditions listed. Some performance characteristics may degrade when the device is not operated under the listed test conditions.

**Table 1. Quality Conformance Inspection Mil-Std-883, Method 5005 - Group A**

Subgroup	Description	Temp °C
1	Static tests at	25
2	Static tests at	125
3	Static tests at	-55
4	Dynamic tests at	25
5	Dynamic tests at	125
6	Dynamic tests at	-55
7	Functional tests at	25
8A	Functional tests at	125
8B	Functional tests at	-55
9	Switching tests at	25
10	Switching tests at	125
11	Switching tests at	-55
12	Settling time at	25
13	Settling time at	125
14	Settling time at	-55

**LM7171 ( $\pm 15$ ) Electrical Characteristics DC Parameters<sup>(1)(2)</sup>**

The following conditions apply, unless otherwise specified.

 DC:  $T_J = 25^\circ\text{C}$ ,  $V^+ = +15\text{V}$ ,  $V^- = -15\text{V}$ ,  $V_{\text{CM}} = 0\text{V}$ , and  $R_L > 1\text{M}\Omega$ 

Symbol	Parameter	Conditions	Notes	Min	Max	Units	Sub-groups
$V_{\text{IO}}$	Input Offset Voltage			-1.0	1.0	mV	1
				-7.0	7.0	mV	2, 3
$+I_{\text{IB}}$	Input Bias Current				10	$\mu\text{A}$	1
					12	$\mu\text{A}$	2, 3
$-I_{\text{IB}}$	Input Bias Current				10	$\mu\text{A}$	1
					12	$\mu\text{A}$	2, 3
$I_{\text{IO}}$	Input Offset Current			-4.0	4.0	$\mu\text{A}$	1
				-6.0	6.0	$\mu\text{A}$	2, 3
CMRR	Common Mode Rejection Ratio	$V_{\text{CM}} = \pm 10\text{V}$		85		dB	1
				70		dB	2, 3
PSRR	Power Supply Rejection Ratio	$V_S = \pm 15\text{V}$ to $\pm 5\text{V}$		85		dB	1
				80		dB	2, 3
$A_V$	Large Signal Voltage Gain	$R_L = 1\text{K}\Omega$ , $V_O = \pm 5\text{V}$	See <sup>(3)</sup>	80		dB	1
			See <sup>(3)</sup>	75		dB	2, 3
		$R_L = 100\Omega$ , $V_O = \pm 5\text{V}$	See <sup>(3)</sup>	75		dB	1
			See <sup>(3)</sup>	70		dB	2, 3
$V_O$	Output Swing	$R_L = 1\text{K}\Omega$		13	-13	V	1
				12.7	-12.7	V	2, 3
		$R_L = 100\Omega$		10.5	-9.5	V	1
				9.5	-9.0	V	2, 3
	Output Current (Open Loop)	Sourcing $R_L = 100\Omega$	See <sup>(4)</sup>	105		mA	1
			See <sup>(4)</sup>	95		mA	2, 3
		Sinking $R_L = 100\Omega$	See <sup>(4)</sup>		-95	mA	1
			See <sup>(4)</sup>		-90	mA	2, 3
$I_S$	Supply Current				8.5	mA	1
					9.5	mA	2, 3

- (1) Pre and post irradiation limits are identical to those listed under AC and DC electrical characteristics except as listed in the Post Radiation Limits Table. These parts may be dose rate sensitive in a space environment and demonstrate enhanced low dose rate effect. Radiation end point limits for the noted parameters are specified only for the conditions as specified in MIL-STD-883, per Test Method 1019, Condition A.
- (2) Pre and post irradiation limits are identical to those listed under AC and DC electrical characteristics except as listed in the Post Radiation Limits Table. Low dose rate testing has been performed on a wafer-by-wafer basis, per Test Method 1019, Condition D of MIL-STD-883, with no enhanced low dose rate sensitivity (ELDRS).
- (3) Large signal voltage gain is the total output swing divided by the input signal required to produce that swing. For  $V_S = \pm 15\text{V}$ ,  $V_{\text{OUT}} = \pm 5\text{V}$ . For  $V_S = \pm 5\text{V}$ ,  $V_{\text{OUT}} = \pm 1\text{V}$ .
- (4) The open loop output current is specified, by the measurement of the open loop output voltage swing, using  $100\Omega$  output load.

### LM7171 ( $\pm 15$ ) Electrical Characteristics AC Parameters<sup>(1)(2)</sup>

The following conditions apply, unless otherwise specified.

AC:  $T_J = 25^\circ\text{C}$ ,  $V^+ = +15\text{V}$ ,  $V^- = -15\text{V}$ ,  $V_{\text{CM}} = 0\text{V}$ , and  $R_L > 1\text{M}\Omega$

Symbol	Parameter	Conditions	Notes	Min	Max	Units	Sub-groups
SR	Slew Rate	$A_V = 2$ , $V_I = \pm 2.5\text{V}$ 3nS Rise & Fall time	See <sup>(3)(4)</sup>	2000		V/ $\mu\text{S}$	4
GBW	Unity-Gain Bandwidth		See <sup>(5)</sup>	170		MHz	4

- (1) Pre and post irradiation limits are identical to those listed under AC and DC electrical characteristics except as listed in the Post Radiation Limits Table. These parts may be dose rate sensitive in a space environment and demonstrate enhanced low dose rate effect. Radiation end point limits for the noted parameters are specified only for the conditions as specified in MIL-STD-883, per Test Method 1019, Condition A.
- (2) Pre and post irradiation limits are identical to those listed under AC and DC electrical characteristics except as listed in the Post Radiation Limits Table. Low dose rate testing has been performed on a wafer-by-wafer basis, per Test Method 1019, Condition D of MIL-STD-883, with no enhanced low dose rate sensitivity (ELDRS).
- (3) See AN00001 for SR test circuit.
- (4) Slew Rate measured between  $\pm 4\text{V}$ .
- (5) See AN00002 for GBW test circuit.

### LM7171 ( $\pm 15$ ) Electrical Characteristics DC Drift Parameters<sup>(1)(2)</sup>

The following conditions apply, unless otherwise specified.

DC:  $T_J = 25^\circ\text{C}$ ,  $V^+ = +15\text{V}$ ,  $V^- = -15\text{V}$ ,  $V_{\text{CM}} = 0\text{V}$ , and  $R_L > 1\text{M}\Omega$

Delta calculations performed on QMLV devices at group B , subgroup 5.

Symbol	Parameter	Conditions	Notes	Min	Max	Units	Sub-groups
$V_{\text{IO}}$	Input Offset Voltage			-250	250	$\mu\text{V}$	1
$+I_{\text{Bias}}$	Input Bias Current			-500	500	nA	1
$-I_{\text{Bias}}$	Input Bias Current			-500	500	nA	1

- (1) Pre and post irradiation limits are identical to those listed under AC and DC electrical characteristics except as listed in the Post Radiation Limits Table. These parts may be dose rate sensitive in a space environment and demonstrate enhanced low dose rate effect. Radiation end point limits for the noted parameters are specified only for the conditions as specified in MIL-STD-883, per Test Method 1019, Condition A.
- (2) Pre and post irradiation limits are identical to those listed under AC and DC electrical characteristics except as listed in the Post Radiation Limits Table. Low dose rate testing has been performed on a wafer-by-wafer basis, per Test Method 1019, Condition D of MIL-STD-883, with no enhanced low dose rate sensitivity (ELDRS).

**LM7171 (±5) Electrical Characteristics DC Parameters<sup>(1)(2)</sup>**

The following conditions apply, unless otherwise specified.

 DC:  $T_J = 25^\circ\text{C}$ ,  $V^+ = +5\text{V}$ ,  $V^- = -5\text{V}$ ,  $V_{CM} = 0\text{V}$ , and  $R_L > 1\text{M}\Omega$ 

Symbol	Parameter	Conditions	Notes	Min	Max	Units	Sub-groups
$V_{IO}$	Input Offset Voltage			-1.5	1.5	mV	1
				-7.0	7.0	mV	2, 3
$+I_{IB}$	Input Bias Current				10	$\mu\text{A}$	1
					12	$\mu\text{A}$	2, 3
$-I_{IB}$	Input Bias Current				10	$\mu\text{A}$	1
					12	$\mu\text{A}$	2, 3
$I_{IO}$	Input Offset Current			-4.0	4.0	$\mu\text{A}$	1
				-6.0	6.0	$\mu\text{A}$	2, 3
CMRR	Common Mode Rejection Ratio	$V_{CM} = \pm 2.5\text{V}$		80		dB	1
				70		dB	2, 3
$A_V$	Large Signal Voltage Gain	$R_L = 1\text{K}\Omega$ , $V_O = \pm 1\text{V}$	See <sup>(3)</sup>	75		dB	1
			See <sup>(3)</sup>	70		dB	2, 3
		$R_L = 100\Omega$ , $V_O = \pm 1\text{V}$	See <sup>(3)</sup>	72		dB	1
			See <sup>(3)</sup>	67		dB	2, 3
$V_O$	Output Swing	$R_L = 1\text{K}\Omega$		3.2	-3.2	V	1
				3.0	-3.0	V	2, 3
		$R_L = 100\Omega$		2.9	-2.9	V	1
				2.8	-2.75	V	2, 3
	Output Current (Open Loop)	Sourcing $R_L = 100\Omega$	See <sup>(4)</sup>	29		mA	1
			See <sup>(4)</sup>	28		mA	2, 3
		Sinking $R_L = 100\Omega$	See <sup>(4)</sup>		-29	mA	1
			See <sup>(4)</sup>		-27.5	mA	2, 3
$I_S$	Supply Current				8.0	mA	1
					9.0	mA	2, 3

- (1) Pre and post irradiation limits are identical to those listed under AC and DC electrical characteristics except as listed in the Post Radiation Limits Table. These parts may be dose rate sensitive in a space environment and demonstrate enhanced low dose rate effect. Radiation end point limits for the noted parameters are specified only for the conditions as specified in MIL-STD-883, per Test Method 1019, Condition A.
- (2) Pre and post irradiation limits are identical to those listed under AC and DC electrical characteristics except as listed in the Post Radiation Limits Table. Low dose rate testing has been performed on a wafer-by-wafer basis, per Test Method 1019, Condition D of MIL-STD-883, with no enhanced low dose rate sensitivity (ELDRS).
- (3) Large signal voltage gain is the total output swing divided by the input signal required to produce that swing. For  $V_S = \pm 15\text{V}$ ,  $V_{OUT} = \pm 5\text{V}$ . For  $V_S = \pm 5\text{V}$ ,  $V_{OUT} = \pm 1\text{V}$ .
- (4) The open loop output current is specified, by the measurement of the open loop output voltage swing, using 100 $\Omega$  output load.

### LM7171 ( $\pm 5$ ) Electrical Characteristics DC Drift Parameters<sup>(1)(2)</sup>

The following conditions apply, unless otherwise specified.

DC:  $T_J = 25^\circ\text{C}$ ,  $V^+ = +5\text{V}$ ,  $V^- = -5\text{V}$ ,  $V_{CM} = 0\text{V}$ , and  $R_L > 1\text{M}\Omega$

Delta calculations performed on QMLV devices at group B , subgroup 5.

Symbol	Parameter	Conditions	Notes	Min	Max	Units	Sub-groups
$V_{IO}$	Input Offset Voltage			-250	250	$\mu\text{V}$	1
$+I_{Bias}$	Input Bias Current			-500	500	nA	1
$-I_{Bias}$	Input Bias Current			-500	500	nA	1

- (1) Pre and post irradiation limits are identical to those listed under AC and DC electrical characteristics except as listed in the Post Radiation Limits Table. These parts may be dose rate sensitive in a space environment and demonstrate enhanced low dose rate effect. Radiation end point limits for the noted parameters are specified only for the conditions as specified in MIL-STD-883, per Test Method 1019, Condition A.
- (2) Pre and post irradiation limits are identical to those listed under AC and DC electrical characteristics except as listed in the Post Radiation Limits Table. Low dose rate testing has been performed on a wafer-by-wafer basis, per Test Method 1019, Condition D of MIL-STD-883, with no enhanced low dose rate sensitivity (ELDRS).



Typical Performance Characteristics

unless otherwise noted,  $T_A = 25^\circ\text{C}$

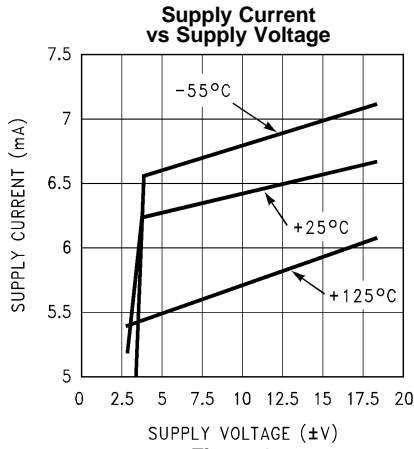

Figure 3.

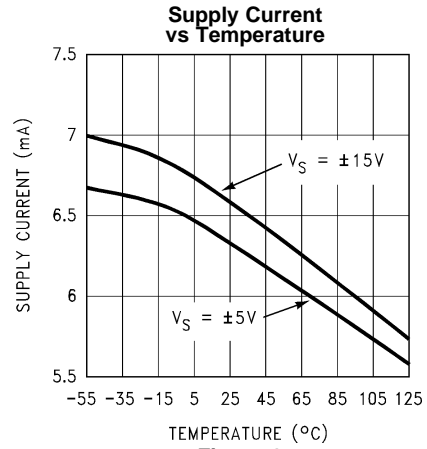

Figure 4.

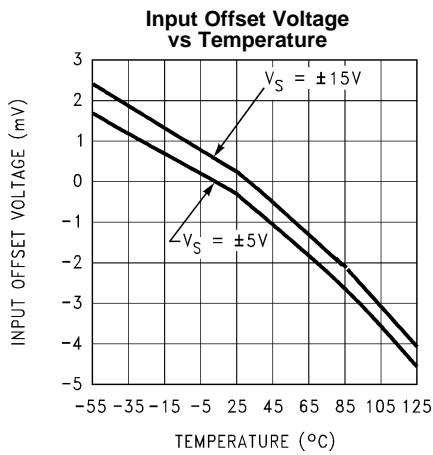

Figure 5.

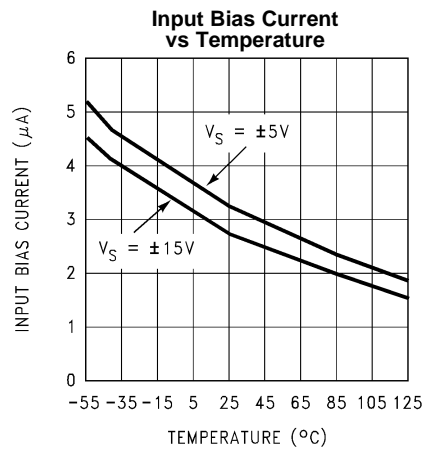

Figure 6.

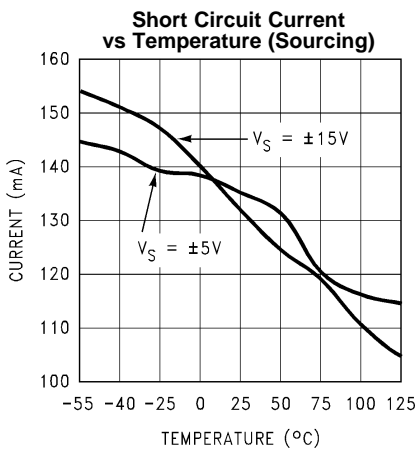

Figure 7.

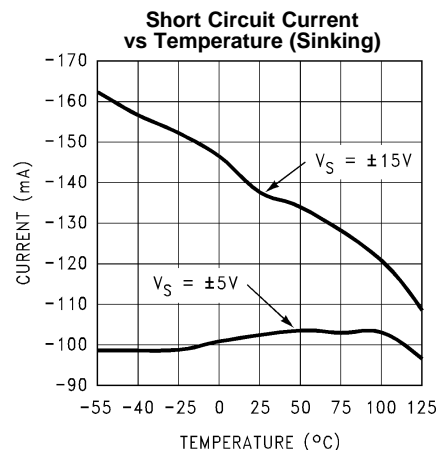

Figure 8.

**Typical Performance Characteristics (continued)**

unless otherwise noted,  $T_A = 25^\circ\text{C}$

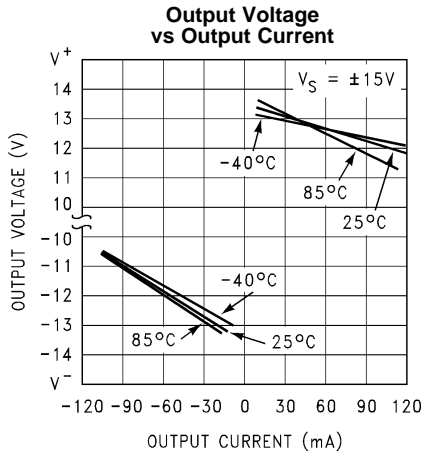

Figure 9.

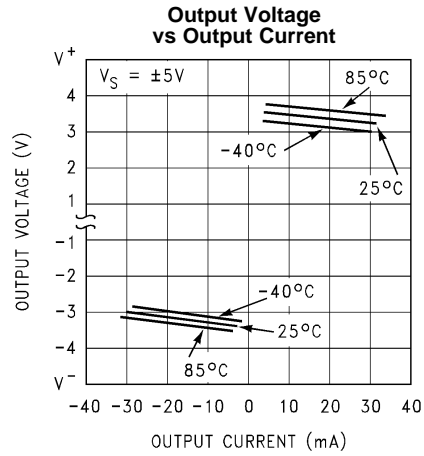

Figure 10.

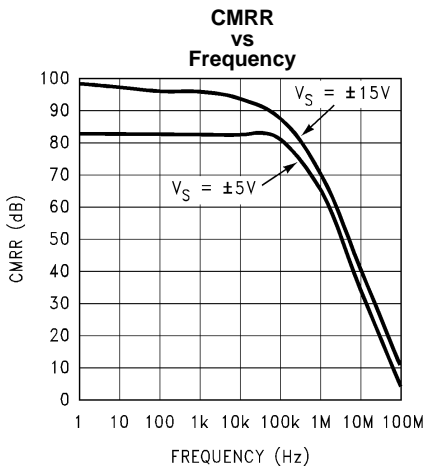

Figure 11.

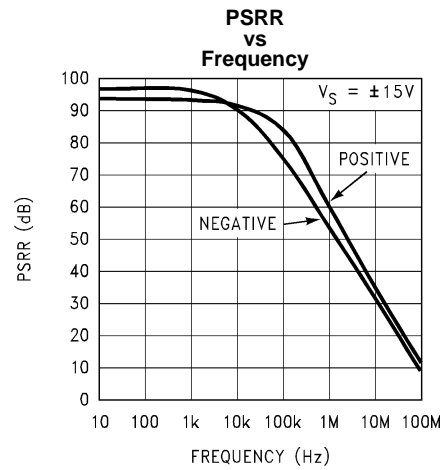

Figure 12.

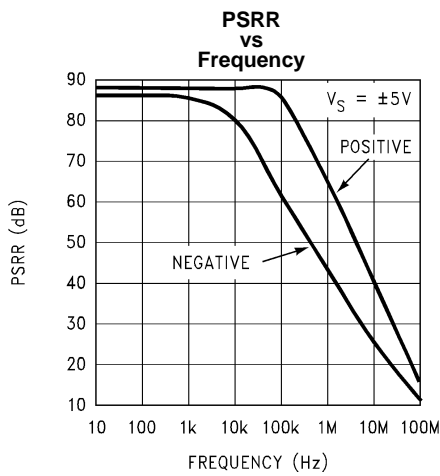

Figure 13.

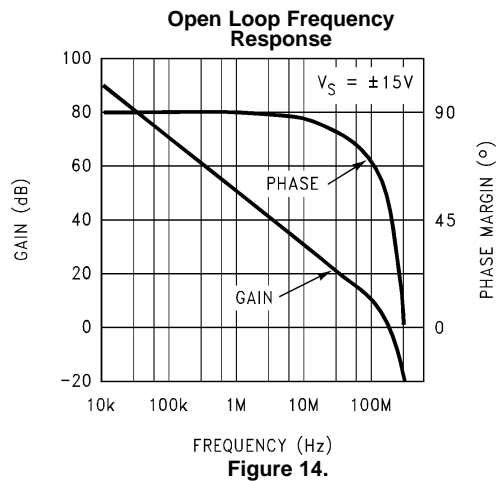

Figure 14.

Typical Performance Characteristics (continued)

unless otherwise noted,  $T_A = 25^\circ\text{C}$

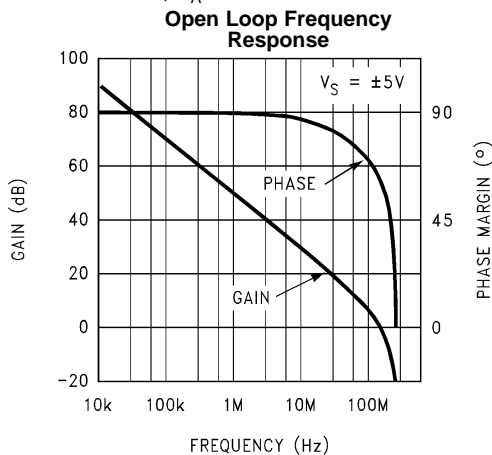

Figure 15.

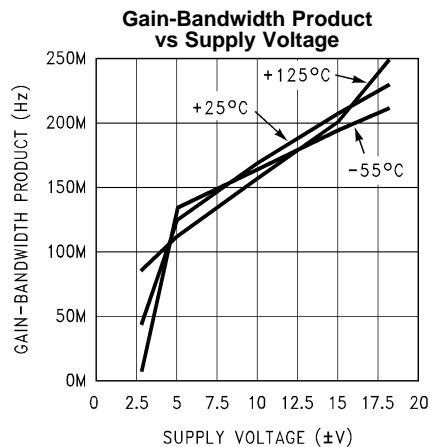

Figure 16.

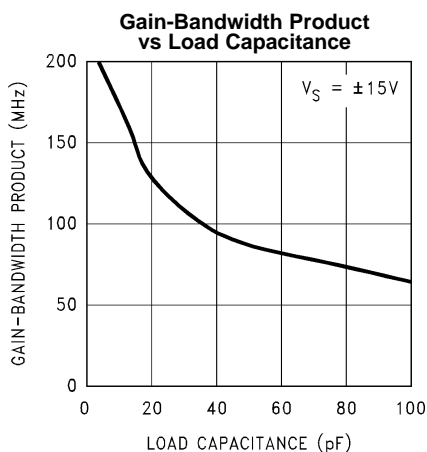

Figure 17.

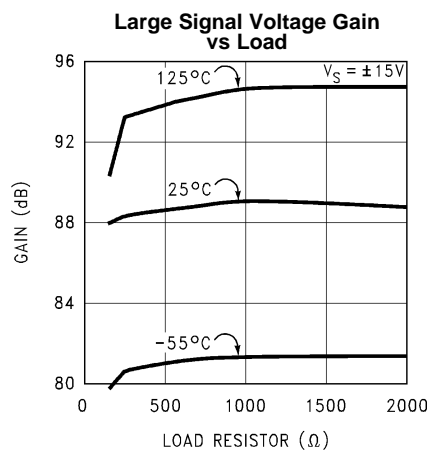

Figure 18.

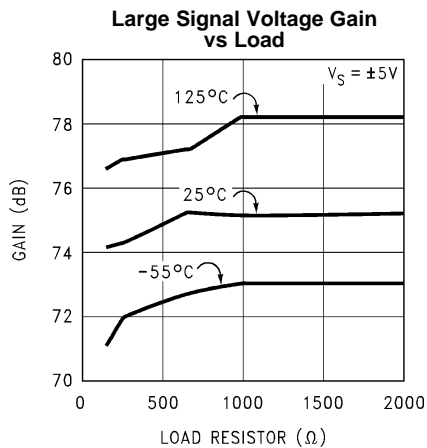

Figure 19.

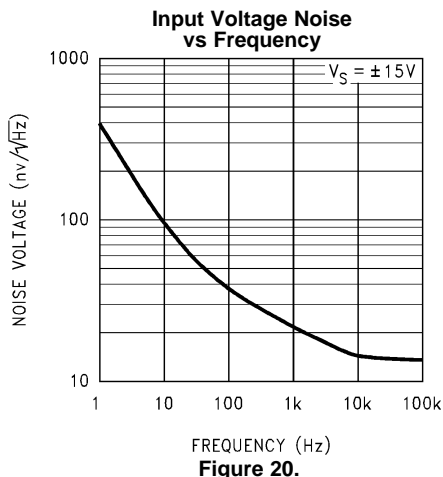
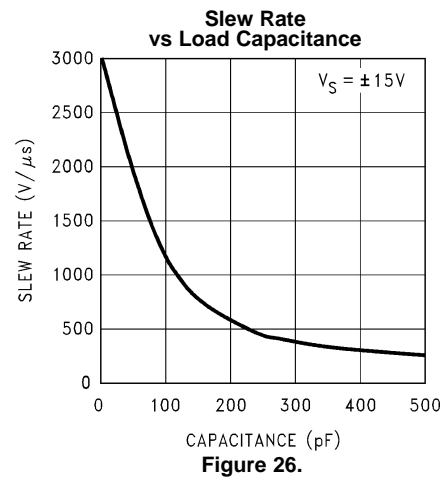
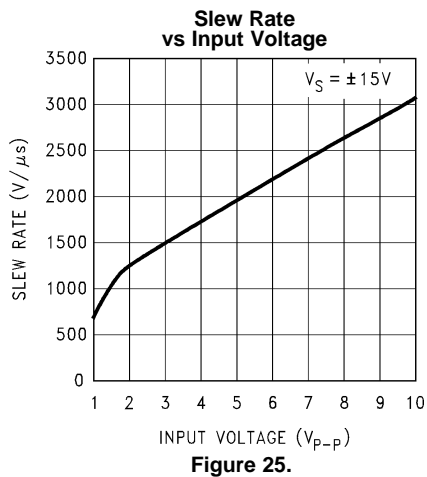
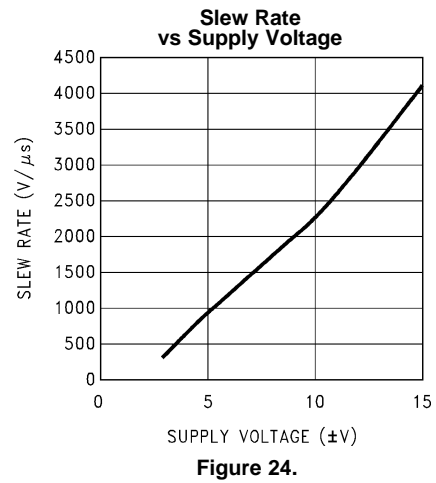
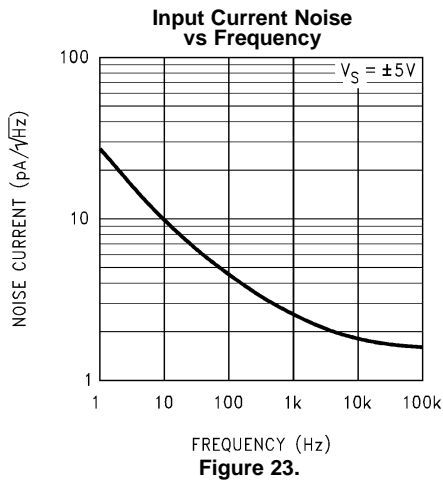
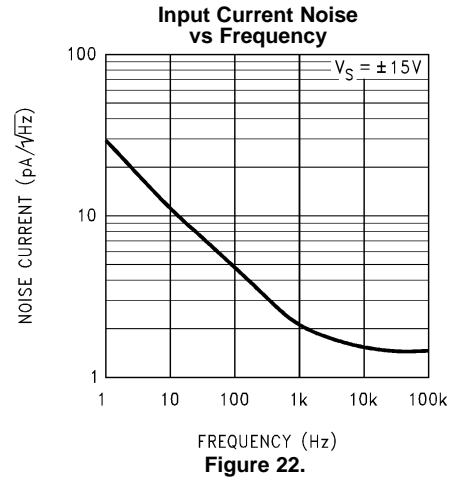
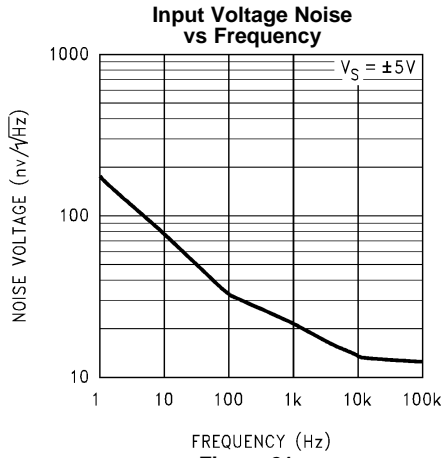

Figure 20.

**Typical Performance Characteristics (continued)**

unless otherwise noted,  $T_A = 25^\circ\text{C}$



Typical Performance Characteristics (continued)

unless otherwise noted,  $T_A = 25^\circ\text{C}$

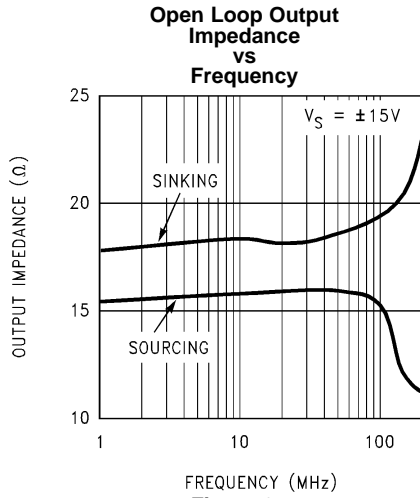

Figure 27.

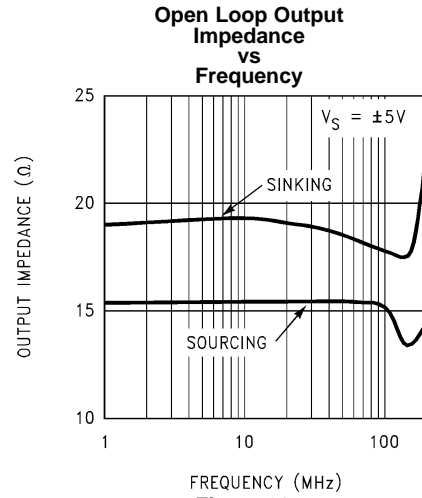

Figure 28.

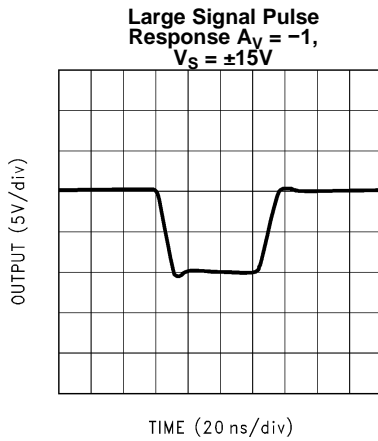

Figure 29.

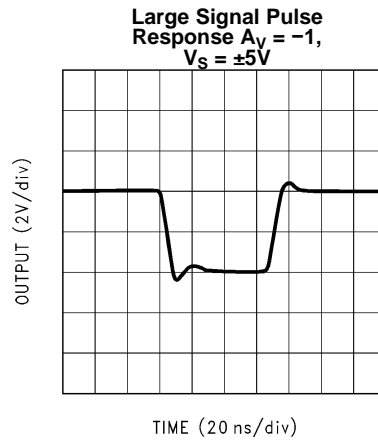

Figure 30.

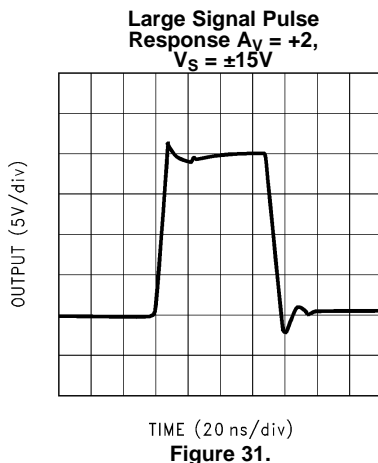

Figure 31.

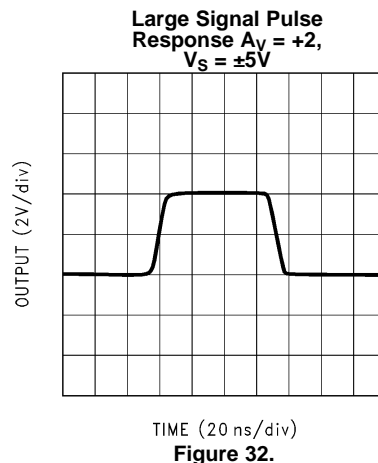
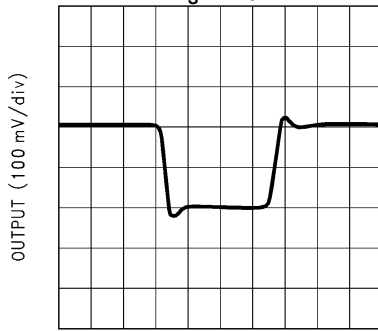

Figure 32.

**Typical Performance Characteristics (continued)**

unless otherwise noted,  $T_A = 25^\circ\text{C}$

**Small Signal Pulse**  
Response  $A_V = -1$ ,  
 $V_S = \pm 15\text{V}$



TIME (20 ns/div)  
**Figure 33.**

**Small Signal Pulse**  
Response  $A_V = -1$ ,  
 $V_S = \pm 5\text{V}$

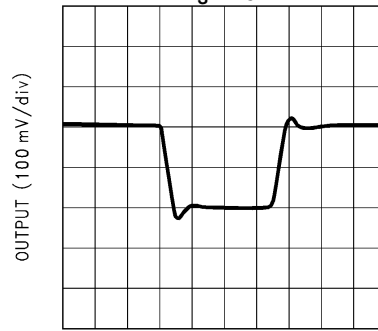

TIME (20 ns/div)  
**Figure 34.**

**Small Signal Pulse**  
Response  $A_V = +2$ ,  
 $V_S = \pm 15\text{V}$

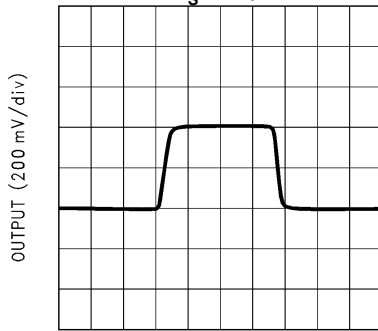

TIME (20 ns/div)  
**Figure 35.**

**Small Signal Pulse**  
Response  $A_V = +2$ ,  
 $V_S = \pm 5\text{V}$

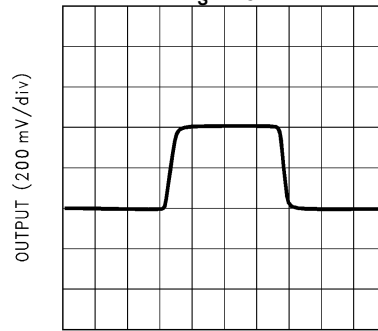

TIME (20 ns/div)  
**Figure 36.**

**Closed Loop Frequency**  
Response  
vs  
Supply  
Voltage ( $A_V = +2$ )

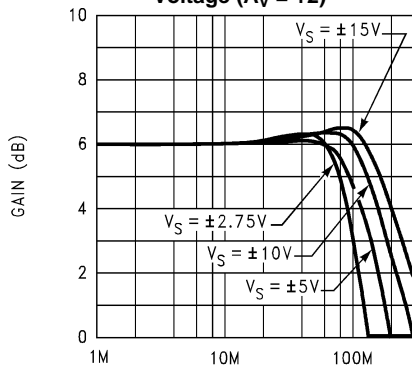

FREQUENCY (Hz)  
**Figure 37.**

**Closed Loop Frequency**  
Response  
vs  
Capacitive  
Load ( $A_V = +2$ )

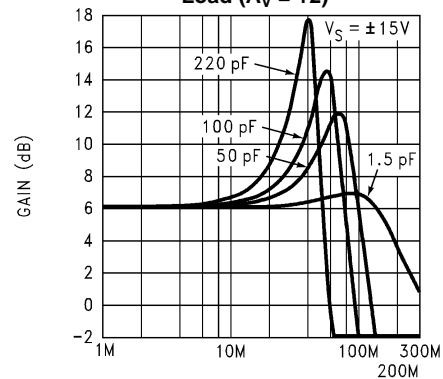

FREQUENCY (Hz)  
**Figure 38.**

Typical Performance Characteristics (continued)

unless otherwise noted,  $T_A = 25^\circ\text{C}$

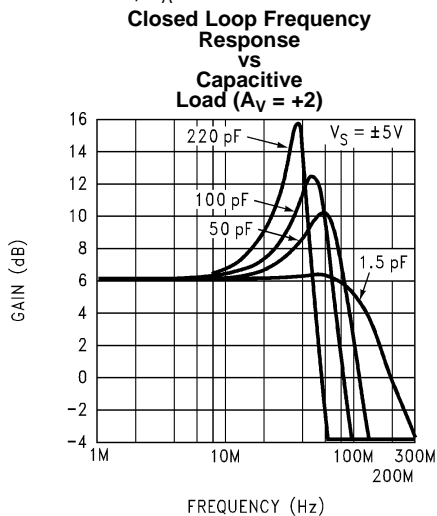

Figure 39.

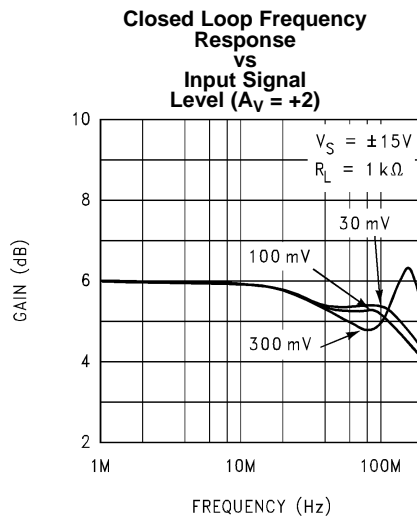

Figure 40.

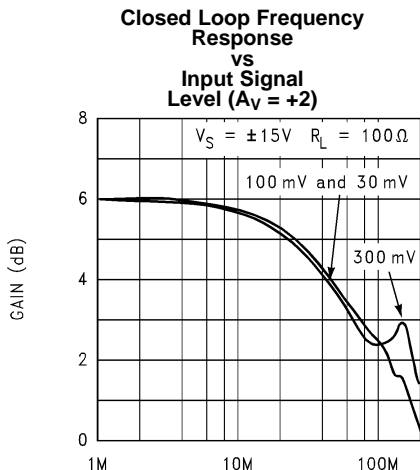

Figure 41.

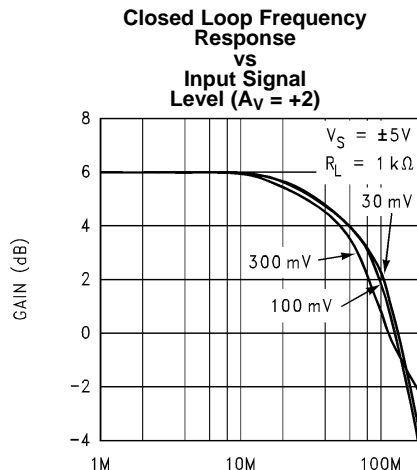

Figure 42.

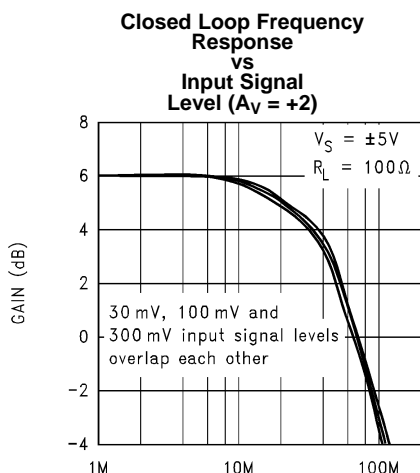

Figure 43.

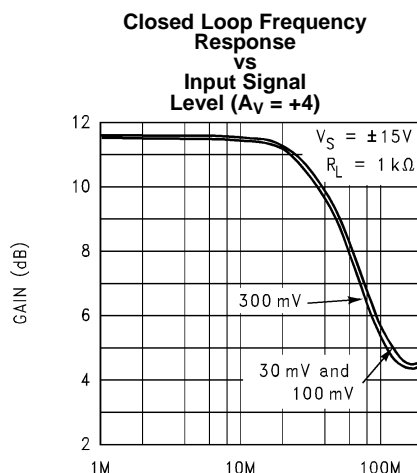

Figure 44.

**Typical Performance Characteristics (continued)**

unless otherwise noted,  $T_A = 25^\circ\text{C}$

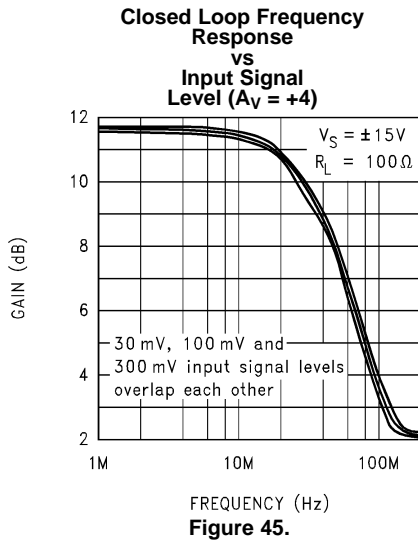

Figure 45.

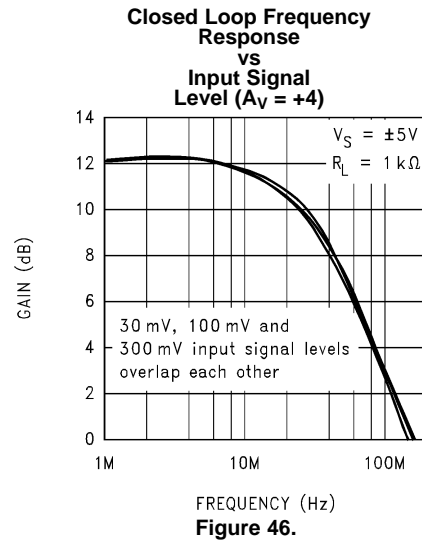

Figure 46.

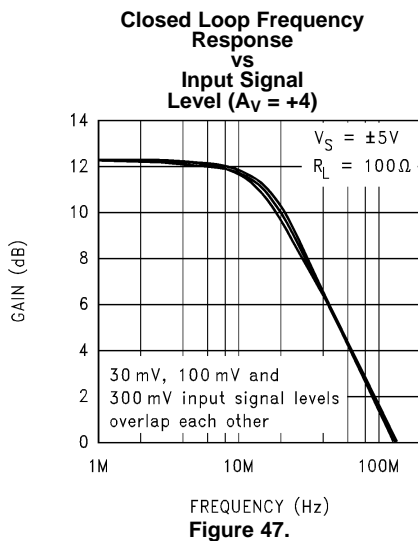

Figure 47.

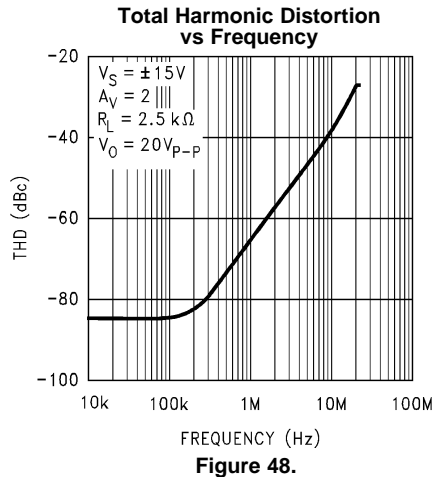

Figure 48.

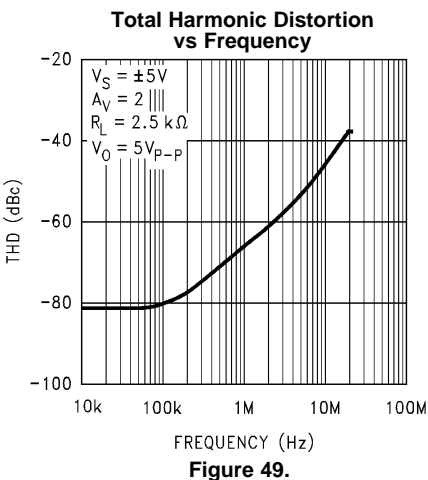

Figure 49.

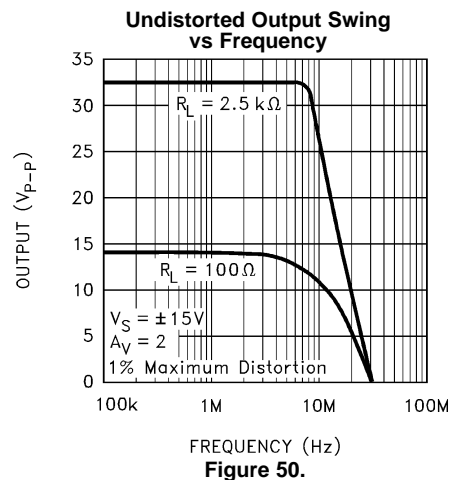

Figure 50.



Typical Performance Characteristics (continued)

unless otherwise noted,  $T_A = 25^\circ\text{C}$

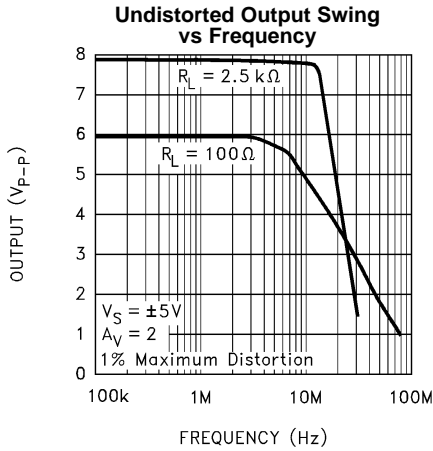

Figure 51.

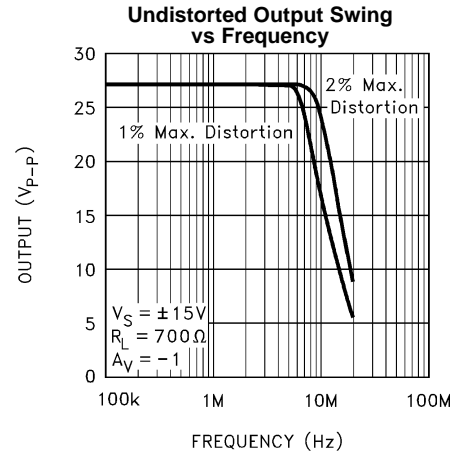

Figure 52.

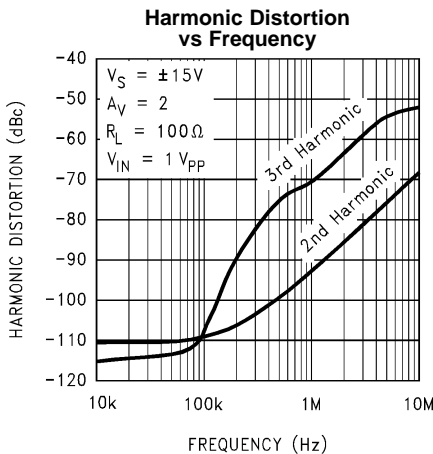

Figure 53.

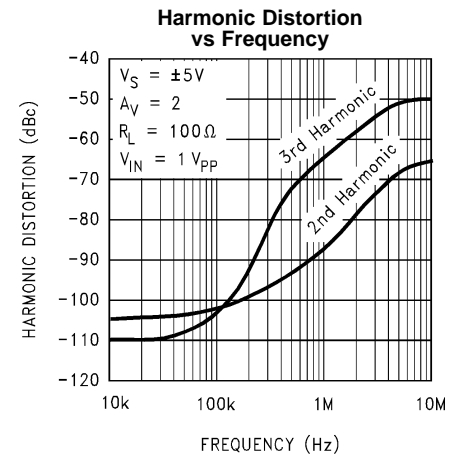
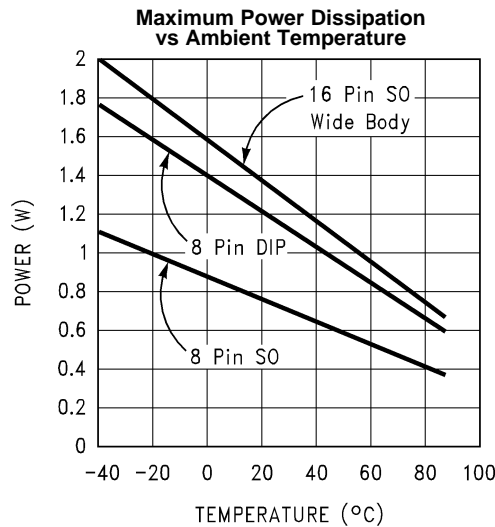

Figure 54.



The THD measurement at low frequency is limited by the test instrument.  
Figure 55.

## APPLICATION NOTES

### LM7171 Performance Discussion

The LM7171 is a very high speed, voltage feedback amplifier. It consumes only 6.5 mA supply current while providing a unity-gain bandwidth of 200 MHz and a slew rate of 4100V/ $\mu$ s. It also has other great features such as low differential gain and phase and high output current.

The LM7171 is a true voltage feedback amplifier. Unlike current feedback amplifiers (CFAs) with a low inverting input impedance and a high non-inverting input impedance, both inputs of voltage feedback amplifiers (VFAs) have high impedance nodes. The low impedance inverting input in CFAs and a feedback capacitor create an additional pole that will lead to instability. As a result, CFAs cannot be used in traditional op amp circuits such as photodiode amplifiers, I-to-V converters and integrators where a feedback capacitor is required.

### LM7171 Circuit Operation

The class AB input stage in the LM7171 is fully symmetrical and has a similar slewing characteristic to the current feedback amplifiers. In the LM7171 Simplified Schematic, Q1 through Q4 form the equivalent of the current feedback input buffer,  $R_E$  the equivalent of the feedback resistor, and stage A buffers the inverting input. The triple-buffered output stage isolates the gain stage from the load to provide low output impedance.

### LM7171 Slew Rate Characteristic

The slew rate of the LM7171 is determined by the current available to charge and discharge an internal high impedance node capacitor. This current is the differential input voltage divided by the total degeneration resistor  $R_E$ . Therefore, the slew rate is proportional to the input voltage level, and the higher slew rates are achievable in the lower gain configurations. A curve of slew rate versus input voltage level is provided in the “Typical Performance Characteristics”.

When a very fast large signal pulse is applied to the input of an amplifier, some overshoot or undershoot occurs. By placing an external resistor such as 1 k $\Omega$  in series with the input of the LM7171, the bandwidth is reduced to help lower the overshoot.

### Slew Rate Limitation

If the amplifier's input signal has too large of an amplitude at too high of a frequency, the amplifier is said to be slew rate limited; this can cause ringing in time domain and peaking in frequency domain at the output of the amplifier.

In the [Typical Performance Characteristics](#) section, there are several curves of  $A_V = +2$  and  $A_V = +4$  versus input signal levels. For the  $A_V = +4$  curves, no peaking is present and the LM7171 responds identically to the different input signal levels of 30 mV, 100 mV and 300 mV.

For the  $A_V = +2$  curves, slight peaking occurs. This peaking at high frequency (>100 MHz) is caused by a large input signal at high enough frequency that exceeds the amplifier's slew rate. The peaking in frequency response does not limit the pulse response in time domain, and the LM7171 is stable with noise gain of  $\geq +2$ .

### Layout Consideration

#### PRINTED CIRCUIT BOARDS AND HIGH SPEED OP AMPS

There are many things to consider when designing PC boards for high speed op amps. Without proper caution, it is very easy to have excessive ringing, oscillation and other degraded AC performance in high speed circuits. As a rule, the signal traces should be short and wide to provide low inductance and low impedance paths. Any unused board space needs to be grounded to reduce stray signal pickup. Critical components should also be grounded at a common point to eliminate voltage drop. Sockets add capacitance to the board and can affect high frequency performance. It is better to solder the amplifier directly into the PC board without using any socket.

### USING PROBES

Active (FET) probes are ideal for taking high frequency measurements because they have wide bandwidth, high input impedance and low input capacitance. However, the probe ground leads provide a long ground loop that will produce errors in measurement. Instead, the probes can be grounded directly by removing the ground leads and probe jackets and using scope probe jacks.

## COMPONENT SELECTION AND FEEDBACK RESISTOR

It is important in high speed applications to keep all component leads short. For discrete components, choose carbon composition-type resistors and mica-type capacitors. Surface mount components are preferred over discrete components for minimum inductive effect.

Large values of feedback resistors can couple with parasitic capacitance and cause undesirable effects such as ringing or oscillation in high speed amplifiers. For the LM7171, a feedback resistor of 510Ω gives optimal performance.

### Compensation for Input Capacitance

The combination of an amplifier's input capacitance with the gain setting resistors, adds a pole that can cause peaking or oscillation. To solve this problem, a feedback capacitor with a value

$$C_F > (R_G \times C_{IN})/R_F \quad (1)$$

can be used to cancel that pole. For the LM7171, a feedback capacitor of 2 pF is recommended. [Figure 56](#) illustrates the compensation circuit.

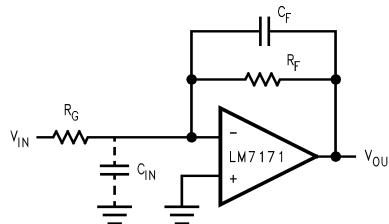

Figure 56. Compensating for Input Capacitance

### Power Supply Bypassing

Bypassing the power supply is necessary to maintain low power supply impedance across frequency. Both positive and negative power supplies should be bypassed individually by placing 0.01 μF ceramic capacitors directly to power supply pins and 2.2 μF tantalum capacitors close to the power supply pins.

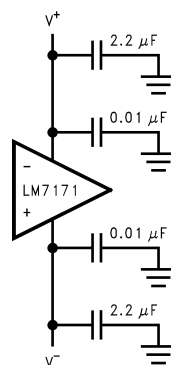
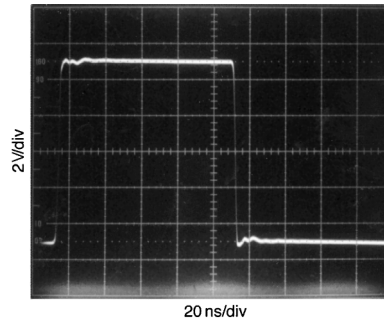

Figure 57. Power Supply Bypassing

### Termination

In high frequency applications, reflections occur if signals are not properly terminated. [Figure 58](#) shows a properly terminated signal while [Figure 59](#) shows an improperly terminated signal.



**Figure 58. Properly Terminated Signal**

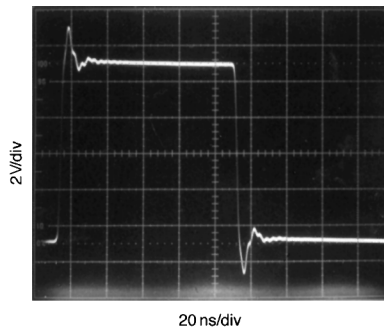
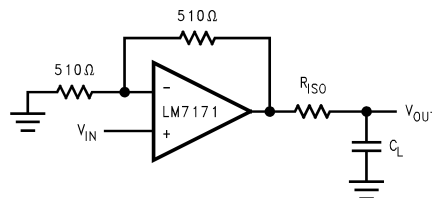

**Figure 59. Improperly Terminated Signal**

To minimize reflection, coaxial cable with matching characteristic impedance to the signal source should be used. The other end of the cable should be terminated with the same value terminator or resistor. For the commonly used cables, RG59 has 75Ω characteristic impedance, and RG58 has 50Ω characteristic impedance.

### Driving Capacitive Loads

Amplifiers driving capacitive loads can oscillate or have ringing at the output. To eliminate oscillation or reduce ringing, an isolation resistor can be placed as shown below in [Figure 60](#). The combination of the isolation resistor and the load capacitor forms a pole to increase stability by adding more phase margin to the overall system. The desired performance depends on the value of the isolation resistor; the bigger the isolation resistor, the more damped the pulse response becomes. For LM7171, a 50Ω isolation resistor is recommended for initial evaluation. [Figure 61](#) shows the LM7171 driving a 150 pF load with the 50Ω isolation resistor.



**Figure 60. Isolation Resistor Used to Drive Capacitive Load**

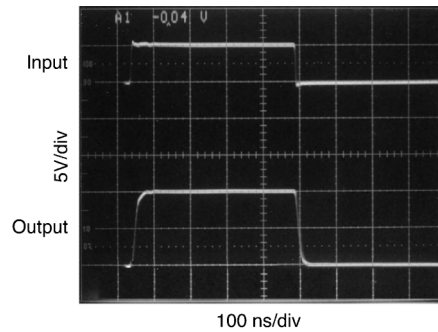

**Figure 61. The LM7171 Driving a 150 pF Load with a 50Ω Isolation Resistor**

## Power Dissipation

The maximum power allowed to dissipate in a device is defined as:

$$P_D = (T_{J(max)} - T_A) / \theta_{JA} \quad (2)$$

### Where

- P<sub>D</sub>** is the power dissipation in a device
- T<sub>J(max)</sub>** is the maximum junction temperature
- T<sub>A</sub>** is the ambient temperature
- θ<sub>JA</sub>** is the thermal resistance of a particular package

For example, for the LM7171 in a CFP package, the maximum power dissipation at 25°C ambient temperature is 680 mW.

Thermal resistance, θ<sub>JA</sub>, depends on parameters such as die size, package size and package material. The smaller the die size and package, the higher θ<sub>JA</sub> becomes. The 8-pin CDIP package has a lower thermal resistance (106°C/W) than that of the CFP (182°C/W). Therefore, for higher dissipation capability, use an 8-pin CDIP package.

The total power dissipated in a device can be calculated as:

$$P_D = P_Q + P_L \quad (3)$$

P<sub>Q</sub> is the quiescent power dissipated in a device with no load connected at the output. P<sub>L</sub> is the power dissipated in the device with a load connected at the output; it is not the power dissipated by the load.

Furthermore,

- P<sub>Q</sub>:** = supply current × total supply voltage with no load
- P<sub>L</sub>:** = output current × (voltage difference between supply voltage and output voltage of the same side of supply voltage)

For example, the total power dissipated by the LM7171 with V<sub>S</sub> = ±15V and output voltage of 10V into 1 kΩ is

$$\begin{aligned} P_D &= P_Q + P_L \\ &= (6.5 \text{ mA}) \times (30\text{V}) + (10 \text{ mA}) \times (15\text{V} - 10\text{V}) \\ &= 195 \text{ mW} + 50 \text{ mW} \\ &= 245 \text{ mW} \end{aligned}$$

Application Circuit

Figure 62. Fast Instrumentation Amplifier

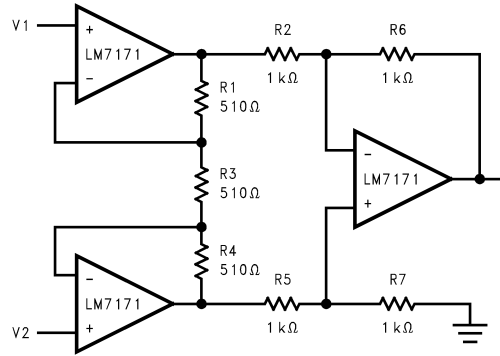

$$V_{IN} = V_2 - V_1$$

if  $R_6 = R_2$ ,  $R_7 = R_5$ , and  $R_1 = R_4$

$$\frac{V_{OUT}}{V_{IN}} = \frac{R_6}{R_2} \left( 1 + 2 \frac{R_1}{R_3} \right) = 3$$

Figure 63. Multivibrator

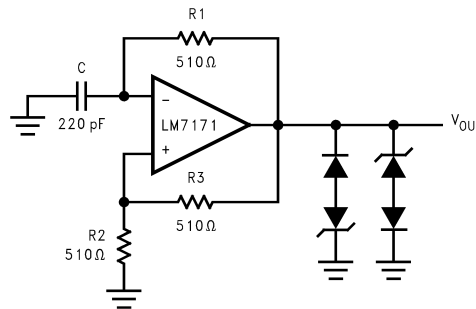

$$f = \frac{1}{2 \left( R_1 C \ln \left( 1 + 2 \frac{R_2}{R_3} \right) \right)}$$

$f = 4 \text{ MHz}$

Figure 64. Pulse Width Modulator

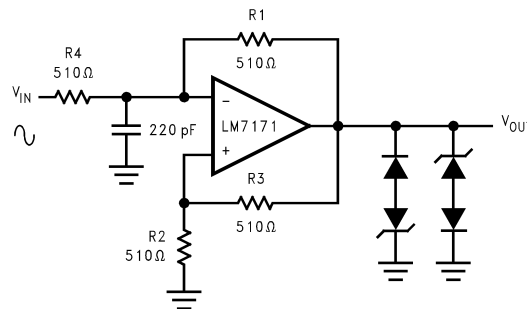
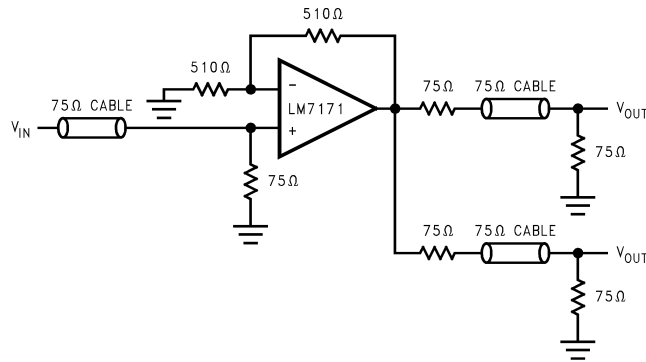

Figure 65. Video Line Driver



**REVISION HISTORY**

Released	Revision	Section	Changes
02/04/09	A	New Release, Corporate format	1 MDS data sheet converted into one Corp. data sheet format. Added ELDRS NSID's to Ordering Information Table. MNLM7171AM-X-RH Rev 0C0 will be archived.

**Changes from Revision B (April 2013) to Revision C**

**Page**

- Changed layout of National Data Sheet to TI format ..... [23](#)



**PACKAGING INFORMATION**

Orderable Device	Status (1)	Package Type	Package Drawing	Pins	Package Qty	Eco Plan (2)	Lead/Ball Finish	MSL Peak Temp (3)	Op Temp (°C)	Device Marking (4/5)	Samples
5962-9553601QPA	NRND	CDIP	NAB	8	40	TBD	Call TI	Call TI	-55 to 125	LM7171AMJQML 5962-95536 01QPA Q ACO 01QPA Q >T	
5962-9553601QXA	ACTIVE	CFP	NAC	10	54	TBD	Call TI	Call TI	-55 to 125	LM7171AM WG Q 5962-95536 01QXA ACO 01QXA >T	Samples
5962F9553601VHA	ACTIVE	CFP	NAD	10	19	TBD	Call TI	Call TI	-55 to 125	LM7171AM WFQMLV Q 5962F95536 01VHA ACO 01VHA >T	Samples
5962F9553601VPA	ACTIVE	CDIP	NAB	8	40	TBD	Call TI	Call TI	-55 to 125	LM7171AMJFQV 5962F95536 01VPA Q ACO 01VPA Q >T	Samples
5962F9553601VXA	ACTIVE	CFP	NAC	10	54	TBD	Call TI	Call TI	-55 to 125	LM7171AM WGFQMLV Q 5962F95536 01VXA ACO 01VXA >T	Samples
LM7171AMJ-QML	NRND	CDIP	NAB	8	40	TBD	Call TI	Call TI	-55 to 125	LM7171AMJQML 5962-95536 01QPA Q ACO 01QPA Q >T	
LM7171AMJFQMLV	ACTIVE	CDIP	NAB	8	40	TBD	Call TI	Call TI	-55 to 125	LM7171AMJFQV 5962F95536 01VPA Q ACO 01VPA Q >T	Samples
LM7171AMWFQMLV	ACTIVE	CFP	NAD	10	19	TBD	Call TI	Call TI	-55 to 125	LM7171AM WFQMLV Q 5962F95536 01VHA ACO 01VHA >T	Samples
LM7171AMWG-QML	ACTIVE	CFP	NAC	10	54	TBD	Call TI	Call TI	-55 to 125	LM7171AM	Samples

Orderable Device	Status (1)	Package Type	Package Drawing	Pins	Package Qty	Eco Plan (2)	Lead/Ball Finish	MSL Peak Temp (3)	Op Temp (°C)	Device Marking (4/5)	Samples
										WG Q 5962-95536 01QXA ACO 01QXA >T	
LM7171AMWGFQMLV	ACTIVE	CFP	NAC	10	54	TBD	Call TI	Call TI	-55 to 125	LM7171AM WGFQMLV Q 5962F95536 01VXA ACO 01VXA >T	Samples

(1) The marketing status values are defined as follows:

**ACTIVE:** Product device recommended for new designs.

**LIFEBUY:** TI has announced that the device will be discontinued, and a lifetime-buy period is in effect.

**NRND:** Not recommended for new designs. Device is in production to support existing customers, but TI does not recommend using this part in a new design.

**PREVIEW:** Device has been announced but is not in production. Samples may or may not be available.

**OBSOLETE:** TI has discontinued the production of the device.

(2) Eco Plan - The planned eco-friendly classification: Pb-Free (RoHS), Pb-Free (RoHS Exempt), or Green (RoHS & no Sb/Br) - please check <http://www.ti.com/productcontent> for the latest availability information and additional product content details.

**TBD:** The Pb-Free/Green conversion plan has not been defined.

**Pb-Free (RoHS):** TI's terms "Lead-Free" or "Pb-Free" mean semiconductor products that are compatible with the current RoHS requirements for all 6 substances, including the requirement that lead not exceed 0.1% by weight in homogeneous materials. Where designed to be soldered at high temperatures, TI Pb-Free products are suitable for use in specified lead-free processes.

**Pb-Free (RoHS Exempt):** This component has a RoHS exemption for either 1) lead-based flip-chip solder bumps used between the die and package, or 2) lead-based die adhesive used between the die and leadframe. The component is otherwise considered Pb-Free (RoHS compatible) as defined above.

**Green (RoHS & no Sb/Br):** TI defines "Green" to mean Pb-Free (RoHS compatible), and free of Bromine (Br) and Antimony (Sb) based flame retardants (Br or Sb do not exceed 0.1% by weight in homogeneous material)

(3) MSL, Peak Temp. -- The Moisture Sensitivity Level rating according to the JEDEC industry standard classifications, and peak solder temperature.

(4) There may be additional marking, which relates to the logo, the lot trace code information, or the environmental category on the device.

(5) Multiple Device Markings will be inside parentheses. Only one Device Marking contained in parentheses and separated by a "~" will appear on a device. If a line is indented then it is a continuation of the previous line and the two combined represent the entire Device Marking for that device.

**Important Information and Disclaimer:** The information provided on this page represents TI's knowledge and belief as of the date that it is provided. TI bases its knowledge and belief on information provided by third parties, and makes no representation or warranty as to the accuracy of such information. Efforts are underway to better integrate information from third parties. TI has taken and continues to take reasonable steps to provide representative and accurate information but may not have conducted destructive testing or chemical analysis on incoming materials and chemicals. TI and TI suppliers consider certain information to be proprietary, and thus CAS numbers and other limited information may not be available for release.

In no event shall TI's liability arising out of such information exceed the total purchase price of the TI part(s) at issue in this document sold by TI to Customer on an annual basis.

**OTHER QUALIFIED VERSIONS OF LM7171QML, LM7171QML-SP :**

- Military: [LM7171QML](#)
- Space: [LM7171QML-SP](#)

NOTE: Qualified Version Definitions:

- Military - QML certified for Military and Defense Applications
- Space - Radiation tolerant, ceramic packaging and qualified for use in Space-based application

NAB0008A

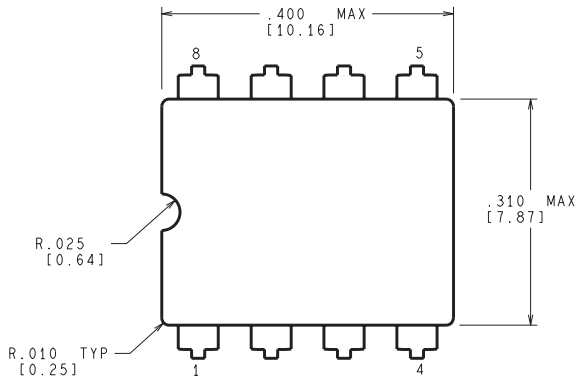

CONTROLLING DIMENSION IS INCH  
VALUES IN [ ] ARE MILLIMETERS

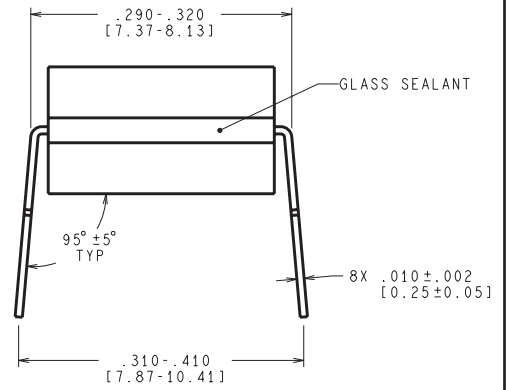
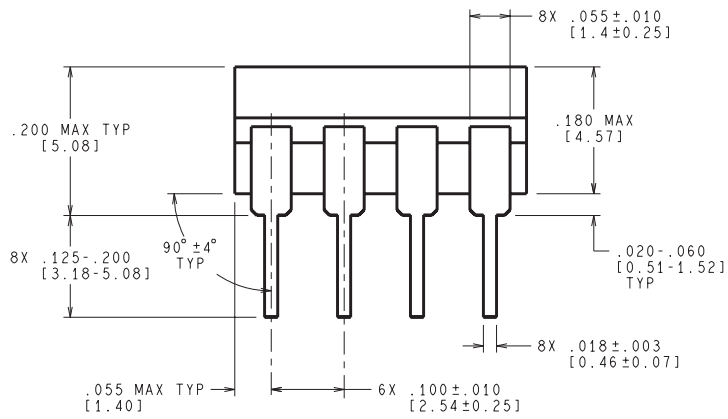

J08A (Rev M)

NAC0010A

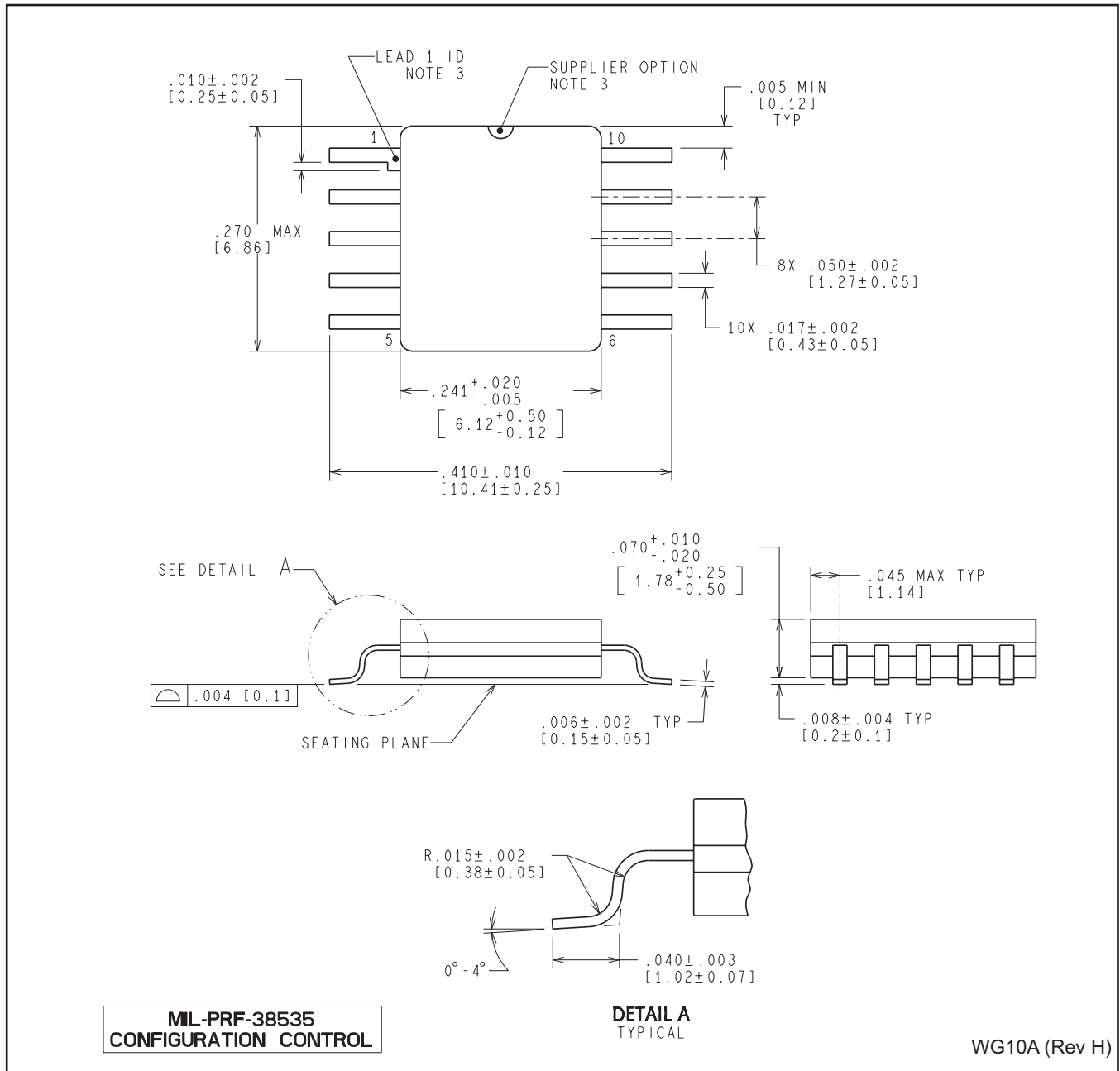

NAD0010A

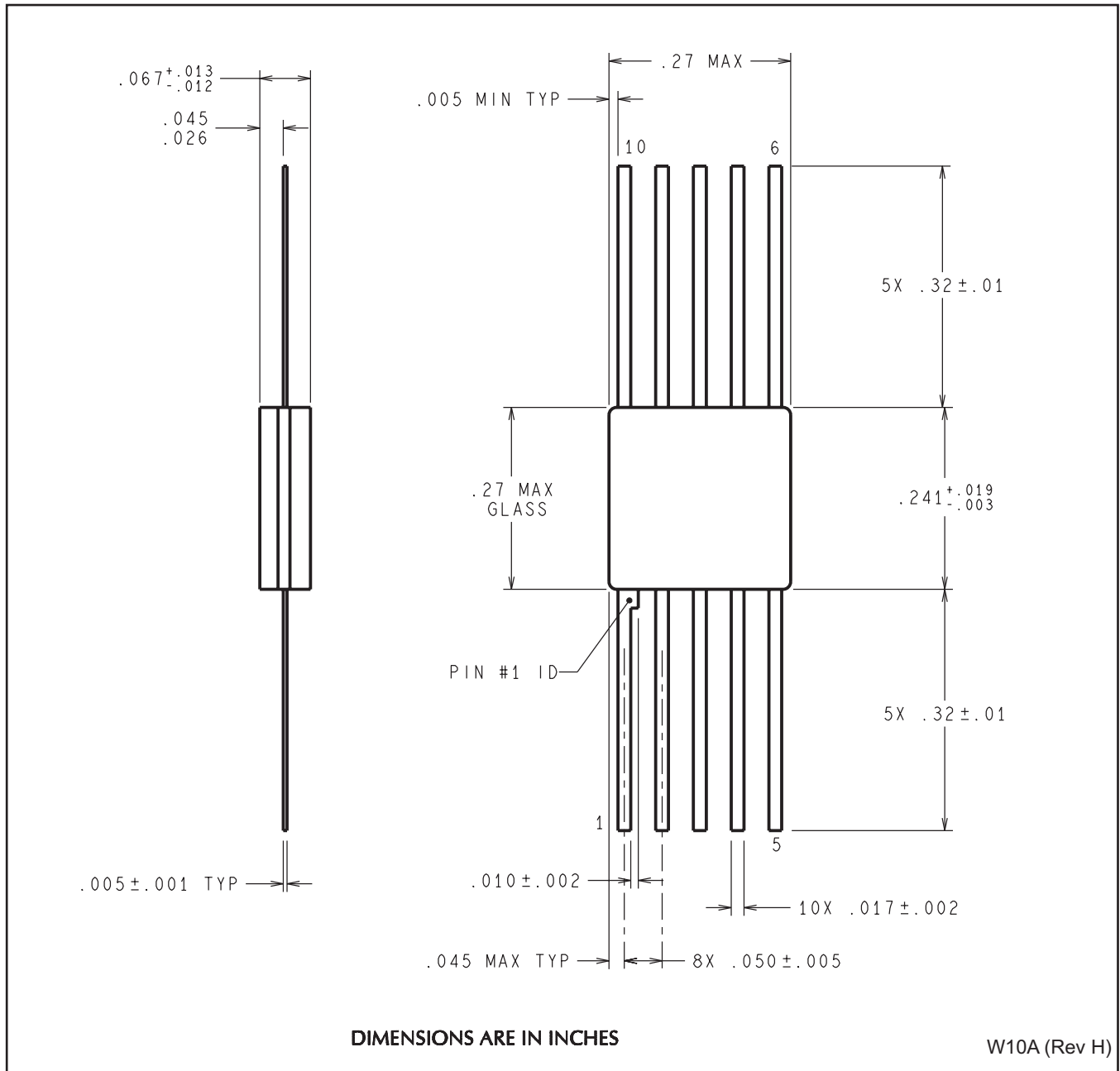

## IMPORTANT NOTICE

Texas Instruments Incorporated and its subsidiaries (TI) reserve the right to make corrections, enhancements, improvements and other changes to its semiconductor products and services per JESD46, latest issue, and to discontinue any product or service per JESD48, latest issue. Buyers should obtain the latest relevant information before placing orders and should verify that such information is current and complete. All semiconductor products (also referred to herein as "components") are sold subject to TI's terms and conditions of sale supplied at the time of order acknowledgment.

TI warrants performance of its components to the specifications applicable at the time of sale, in accordance with the warranty in TI's terms and conditions of sale of semiconductor products. Testing and other quality control techniques are used to the extent TI deems necessary to support this warranty. Except where mandated by applicable law, testing of all parameters of each component is not necessarily performed.

TI assumes no liability for applications assistance or the design of Buyers' products. Buyers are responsible for their products and applications using TI components. To minimize the risks associated with Buyers' products and applications, Buyers should provide adequate design and operating safeguards.

TI does not warrant or represent that any license, either express or implied, is granted under any patent right, copyright, mask work right, or other intellectual property right relating to any combination, machine, or process in which TI components or services are used. Information published by TI regarding third-party products or services does not constitute a license to use such products or services or a warranty or endorsement thereof. Use of such information may require a license from a third party under the patents or other intellectual property of the third party, or a license from TI under the patents or other intellectual property of TI.

Reproduction of significant portions of TI information in TI data books or data sheets is permissible only if reproduction is without alteration and is accompanied by all associated warranties, conditions, limitations, and notices. TI is not responsible or liable for such altered documentation. Information of third parties may be subject to additional restrictions.

Resale of TI components or services with statements different from or beyond the parameters stated by TI for that component or service voids all express and any implied warranties for the associated TI component or service and is an unfair and deceptive business practice. TI is not responsible or liable for any such statements.

Buyer acknowledges and agrees that it is solely responsible for compliance with all legal, regulatory and safety-related requirements concerning its products, and any use of TI components in its applications, notwithstanding any applications-related information or support that may be provided by TI. Buyer represents and agrees that it has all the necessary expertise to create and implement safeguards which anticipate dangerous consequences of failures, monitor failures and their consequences, lessen the likelihood of failures that might cause harm and take appropriate remedial actions. Buyer will fully indemnify TI and its representatives against any damages arising out of the use of any TI components in safety-critical applications.

In some cases, TI components may be promoted specifically to facilitate safety-related applications. With such components, TI's goal is to help enable customers to design and create their own end-product solutions that meet applicable functional safety standards and requirements. Nonetheless, such components are subject to these terms.

No TI components are authorized for use in FDA Class III (or similar life-critical medical equipment) unless authorized officers of the parties have executed a special agreement specifically governing such use.

Only those TI components which TI has specifically designated as military grade or "enhanced plastic" are designed and intended for use in military/aerospace applications or environments. Buyer acknowledges and agrees that any military or aerospace use of TI components which have **not** been so designated is solely at the Buyer's risk, and that Buyer is solely responsible for compliance with all legal and regulatory requirements in connection with such use.

TI has specifically designated certain components as meeting ISO/TS16949 requirements, mainly for automotive use. In any case of use of non-designated products, TI will not be responsible for any failure to meet ISO/TS16949.

### Products

Audio	<a href="http://www.ti.com/audio">www.ti.com/audio</a>
Amplifiers	<a href="http://amplifier.ti.com">amplifier.ti.com</a>
Data Converters	<a href="http://dataconverter.ti.com">dataconverter.ti.com</a>
DLP® Products	<a href="http://www.dlp.com">www.dlp.com</a>
DSP	<a href="http://dsp.ti.com">dsp.ti.com</a>
Clocks and Timers	<a href="http://www.ti.com/clocks">www.ti.com/clocks</a>
Interface	<a href="http://interface.ti.com">interface.ti.com</a>
Logic	<a href="http://logic.ti.com">logic.ti.com</a>
Power Mgmt	<a href="http://power.ti.com">power.ti.com</a>
Microcontrollers	<a href="http://microcontroller.ti.com">microcontroller.ti.com</a>
RFID	<a href="http://www.ti-rfid.com">www.ti-rfid.com</a>
OMAP Applications Processors	<a href="http://www.ti.com/omap">www.ti.com/omap</a>
Wireless Connectivity	<a href="http://www.ti.com/wirelessconnectivity">www.ti.com/wirelessconnectivity</a>

### Applications

Automotive and Transportation	<a href="http://www.ti.com/automotive">www.ti.com/automotive</a>
Communications and Telecom	<a href="http://www.ti.com/communications">www.ti.com/communications</a>
Computers and Peripherals	<a href="http://www.ti.com/computers">www.ti.com/computers</a>
Consumer Electronics	<a href="http://www.ti.com/consumer-apps">www.ti.com/consumer-apps</a>
Energy and Lighting	<a href="http://www.ti.com/energy">www.ti.com/energy</a>
Industrial	<a href="http://www.ti.com/industrial">www.ti.com/industrial</a>
Medical	<a href="http://www.ti.com/medical">www.ti.com/medical</a>
Security	<a href="http://www.ti.com/security">www.ti.com/security</a>
Space, Avionics and Defense	<a href="http://www.ti.com/space-avionics-defense">www.ti.com/space-avionics-defense</a>
Video and Imaging	<a href="http://www.ti.com/video">www.ti.com/video</a>

### TI E2E Community

[e2e.ti.com](http://e2e.ti.com)