

## LM837 Low Noise Quad Operational Amplifier

 Check for Samples: [LM837](#)

### FEATURES

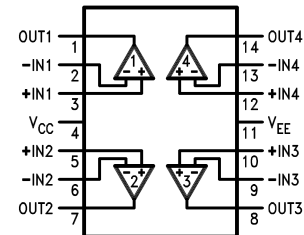
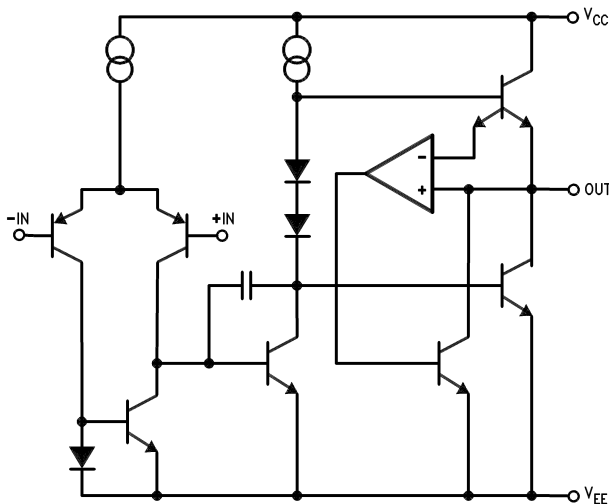
- High Slew Rate 10 V/μs (typ); 8 V/μs (min)
- Wide Gain Bandwidth Product 25 MHz (typ); 15 MHz (min)
- Power Bandwidth 200 kHz (typ)
- High Output Current ±40 mA
- Excellent Output Drive Performance >600Ω
- Low Input Noise Voltage 4.5 nV/√Hz
- Low Total Harmonic Distortion 0.0015%
- Low Offset Voltage 0.3 mV

### DESCRIPTION

The LM837 is a quad operational amplifier designed for low noise, high speed and wide bandwidth performance. It has a new type of output stage which can drive a 600Ω load, making it ideal for almost all digital audio, graphic equalizer, preamplifiers, and professional audio applications. Its high performance characteristics also make it suitable for instrumentation applications where low noise is the key consideration.

The LM837 is internally compensated for unity gain operation. It is pin compatible with most other standard quad op amps and can therefore be used to upgrade existing systems with little or no change.

### Schematic and Connection Diagrams



**Figure 1. PDIP Package  
Top View  
See Package Number  
D0014A or NFF0014A**



Please be aware that an important notice concerning availability, standard warranty, and use in critical applications of Texas Instruments semiconductor products and disclaimers thereto appears at the end of this data sheet.

All trademarks are the property of their respective owners.



These devices have limited built-in ESD protection. The leads should be shorted together or the device placed in conductive foam during storage or handling to prevent electrostatic damage to the MOS gates.

## ABSOLUTE MAXIMUM RATINGS<sup>(1)(2)</sup>

Supply Voltage, $V_{CC}/V_{EE}$	±18V
Differential Input Voltage, $V_{ID}^{(3)}$	±30V
Common Mode Input Voltage, $V_{IC}^{(3)}$	±15V
Power Dissipation, $P_D^{(4)}$	1.2W (N) 830 mW (M)
Operating Temperature Range, $T_{OPR}$	-40°C to +85°C
Storage Temperature Range, $T_{STG}$	-60°C to +150°C
Soldering Information PDIP Package Soldering (10 seconds)	260°C
SOIC Package Vapor Phase (60 seconds)	215°C
Infrared (15 seconds)	220°C
ESD rating to be determined.	
See <a href="http://www.ti.com">http://www.ti.com</a> for other methods of soldering surface mount devices.	

- (1) Absolute Maximum Ratings indicate limits beyond which damage to the device may occur. Operating Ratings indicate conditions for which the device is functional, but do not ensure specific performance limits. Electrical Characteristics state DC and AC electrical specifications under particular test conditions which ensure specific performance limits. This assumes that the device is within the Operating Ratings. Specifications are not specified for parameters where no limit is given, however, the typical value is a good indication of device performance.
- (2) If Military/Aerospace specified devices are required, please contact the Texas Instruments Sales Office/Distributors for availability and specifications.
- (3) Unless otherwise specified the absolute maximum input voltage is equal to the power supply voltage.
- (4) For operation at ambient temperatures above 25°C, the device must be derated based on a 150°C maximum junction temperature and a thermal resistance, junction to ambient, as follows: LM837N, 90°C/W; LM837M, 150°C/W.

## DC ELECTRICAL CHARACTERISTICS

$T_A = 25^\circ\text{C}$ ,  $V_S = \pm 15\text{V}$

Symbol	Parameter	Condition	Min	Typ	Max	Units
$V_{OS}$	Input Offset Voltage	$R_S = 50\Omega$		0.3	5	mV
$I_{OS}$	Input Offset Current			10	200	nA
$I_B$	Input Bias Current			500	1000	nA
$A_V$	Large Signal Voltage Gain	$R_L = 2\text{ k}\Omega$ , $V_{OUT} = \pm 10\text{V}$	90	110		dB
$V_{OM}$	Output Voltage Swing	$R_L = 2\text{ k}\Omega$	±12	±13.5		V
		$R_L = 600\Omega$	±10	±12.5		V
$V_{CM}$	Common Mode Input Voltage		±12	±14.0		V
CMRR	Common Mode Rejection Ratio	$V_{IN} = \pm 12\text{V}$	80	100		dB
PSRR	Power Supply Rejection Ratio	$V_S = 15 \sim 5$ , $-15 \sim -5$	80	100		dB
$I_S$	Power Supply Current	$R_L = \infty$ , Four Amps		10	15	mA

## AC ELECTRICAL CHARACTERISTICS

$T_A = 25^\circ\text{C}$ ,  $V_S = \pm 15\text{V}$

Symbol	Parameter	Condition	Min	Typ	Max	Units
SR	Slew Rate	$R_L = 600\Omega$	8	10		V/μs
GBW	Gain Bandwidth Product	$f = 100\text{ kHz}$ , $R_L = 600\Omega$	15	25		MHz

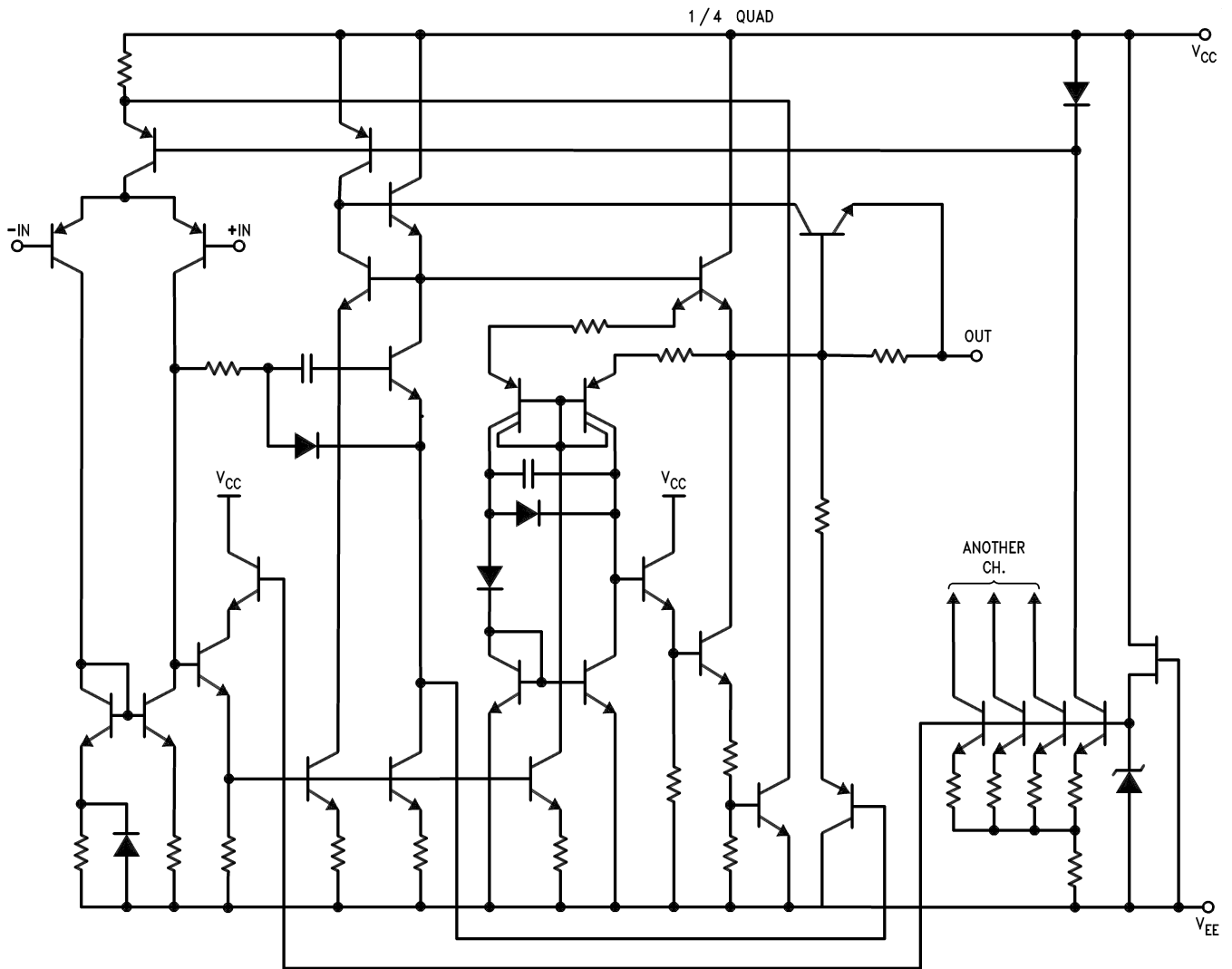
## DESIGN ELECTRICAL CHARACTERISTICS

 $T_A = 25^\circ\text{C}$ ,  $V_S = \pm 15\text{V}$  <sup>(1)</sup>

Symbol	Parameter	Condition	Min	Typ	Max	Units
PBW	Power Bandwidth	$V_O = 25\text{ V}_{P-P}$ , $R_L = 600\Omega$ , THD < 1%		200		kHz
$e_{n1}$	Equivalent Input Noise Voltage	JIS A, $R_S = 100\Omega$		0.5		$\mu\text{V}$
$e_{n2}$	Equivalent Input Noise Voltage	$f = 1\text{ kHz}$		4.5		$\text{nV}/\sqrt{\text{Hz}}$
$i_n$	Equivalent Input Noise Current	$f = 1\text{ kHz}$		0.7		$\text{pA}/\sqrt{\text{Hz}}$
THD	Total Harmonic Distortion	$A_V = 1$ , $V_{OUT} = 3\text{ V}_{rms}$ , $f = 20 \sim 20\text{ kHz}$ , $R_L = 600\Omega$		0.0015		%
$f_U$	Zero Cross Frequency	Open Loop		12		MHz
$\Phi_m$	Phase Margin	Open Loop		45		deg
	Input-Referred Crosstalk	$f = 20 \sim 20\text{ kHz}$		-120		dB
$\frac{\Delta V_{OS}}{\Delta T}$	Average TC of Input Offset Voltage			2		$\mu\text{V}/^\circ\text{C}$

(1) The following parameters are not tested or ensured.

DETAILED SCHEMATIC



TYPICAL PERFORMANCE CHARACTERISTICS

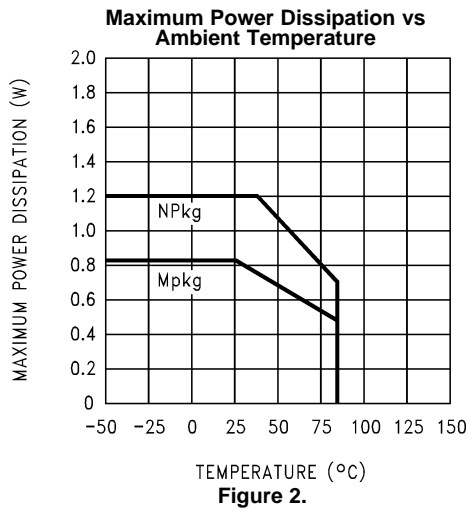


Figure 2.

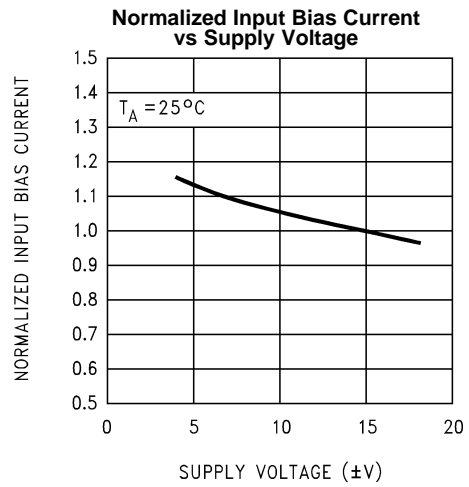


Figure 3.

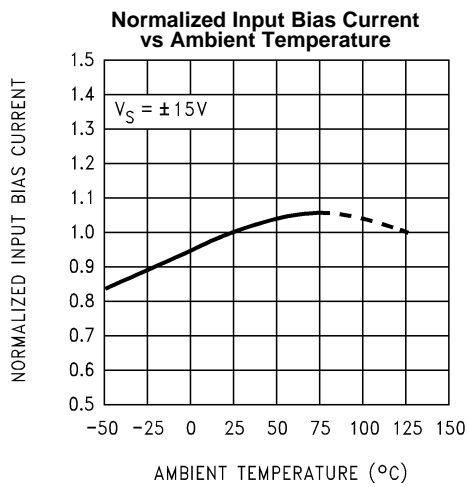


Figure 4.

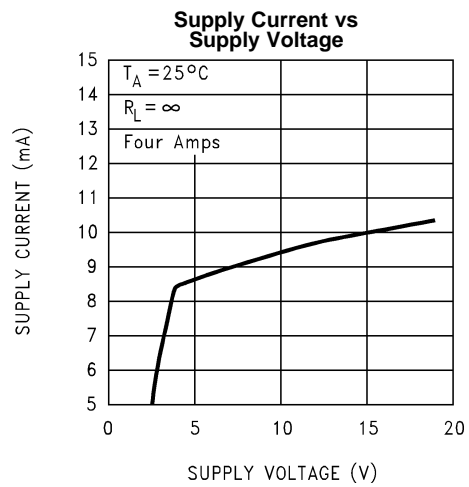


Figure 5.

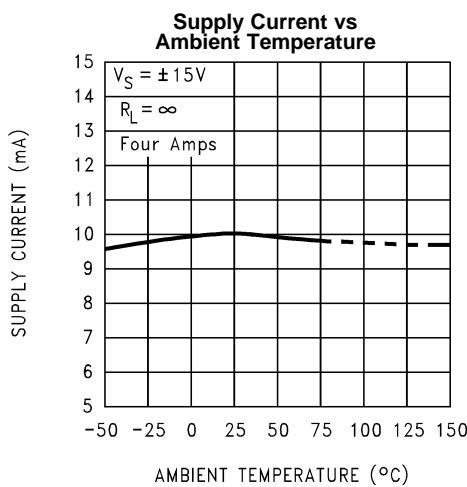


Figure 6.

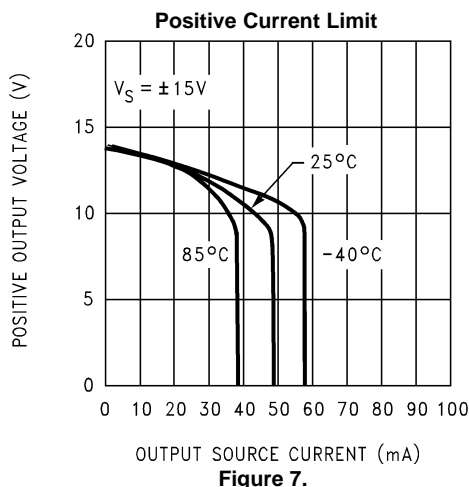
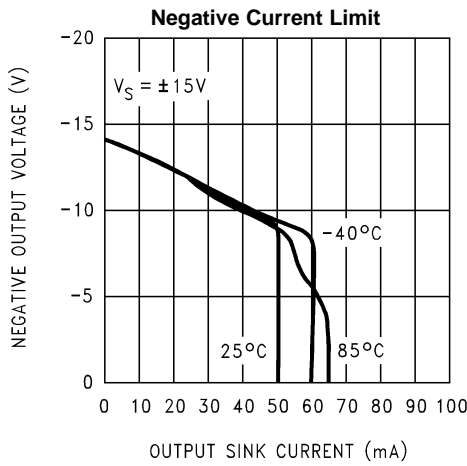
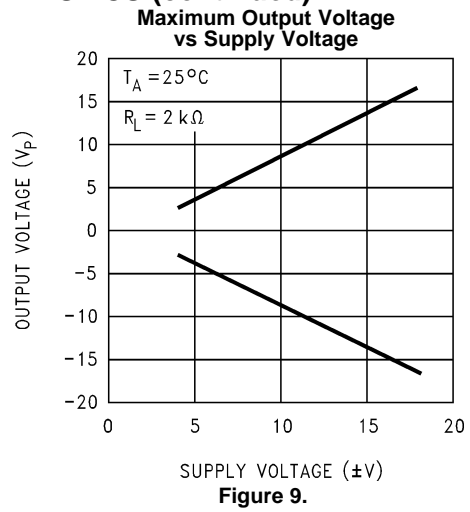


Figure 7.

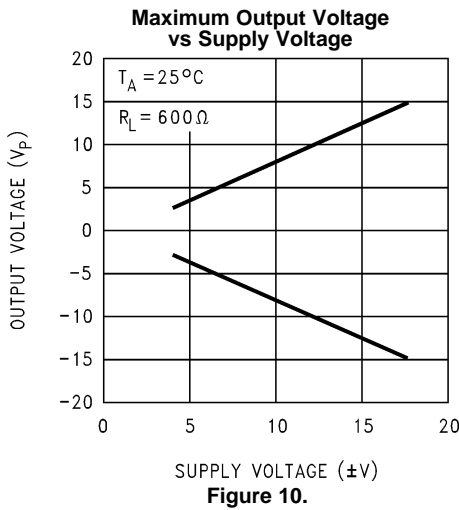
**TYPICAL PERFORMANCE CHARACTERISTICS (continued)**



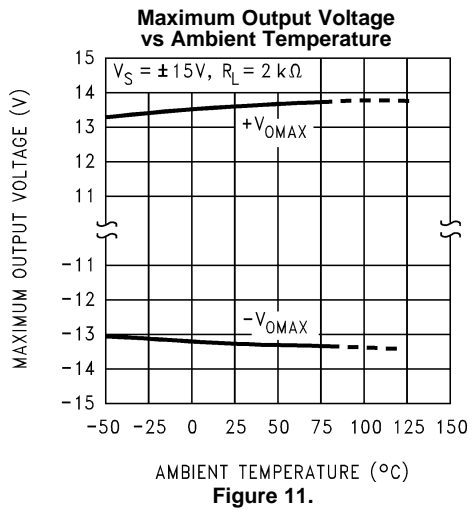
**Figure 8.**



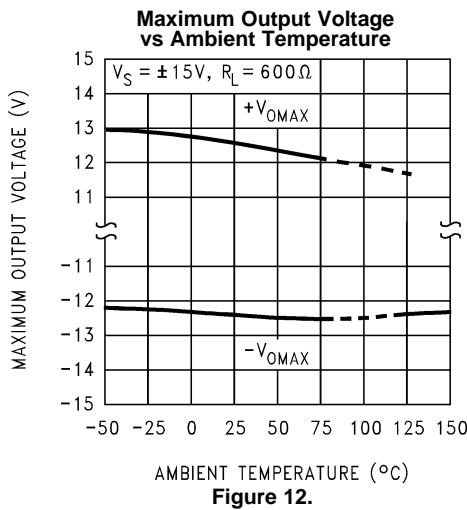
**Figure 9.**



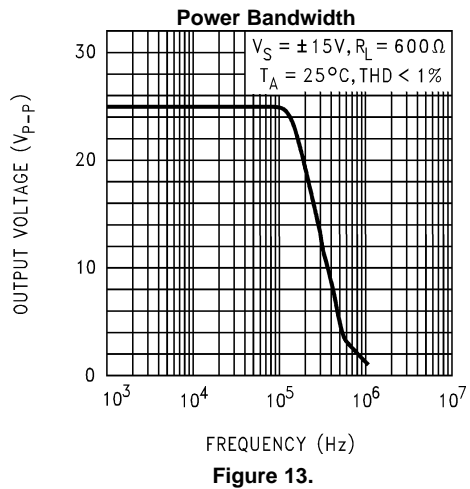
**Figure 10.**



**Figure 11.**

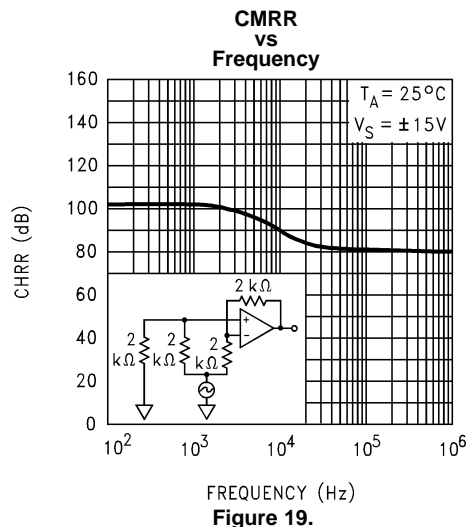
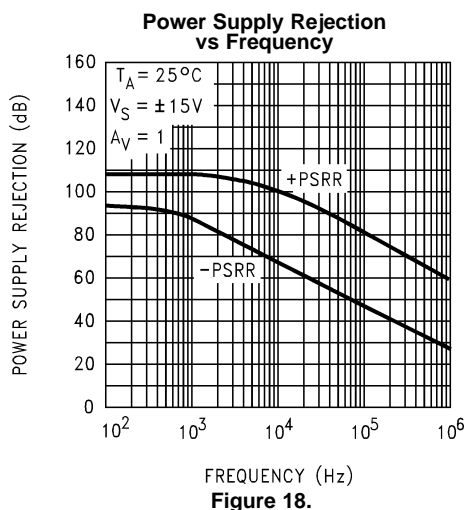
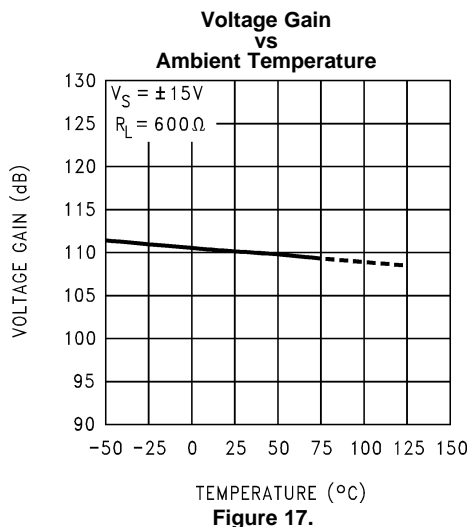
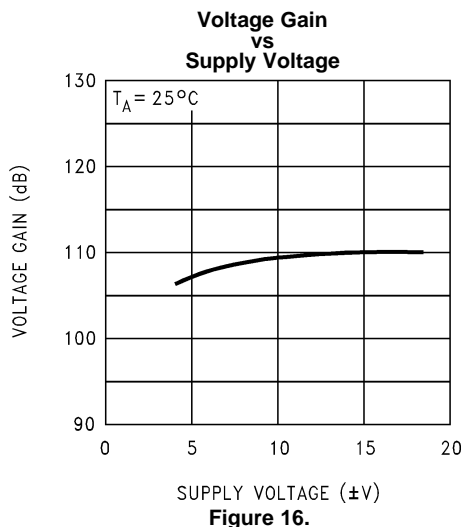
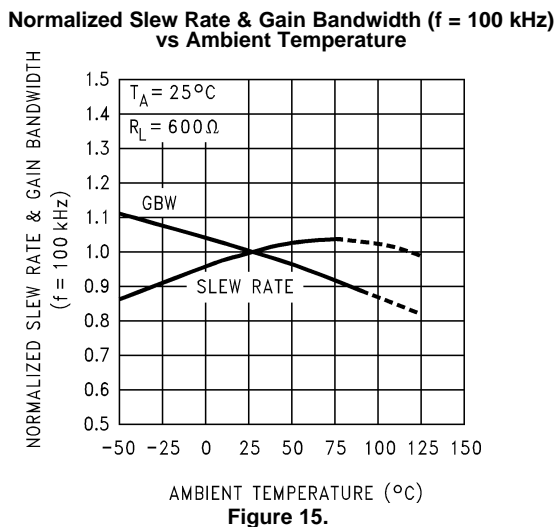
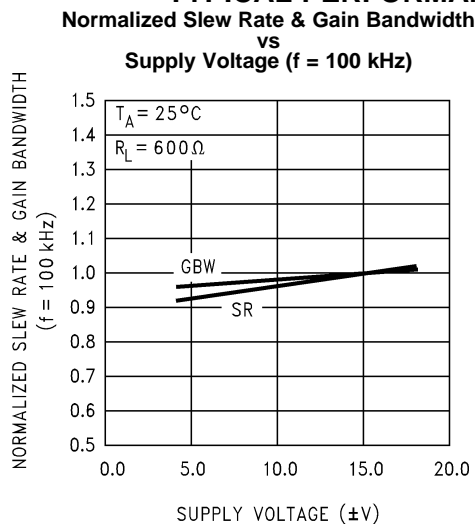


**Figure 12.**



**Figure 13.**

**TYPICAL PERFORMANCE CHARACTERISTICS (continued)**



**TYPICAL PERFORMANCE CHARACTERISTICS (continued)**

**Open Loop Gain & Phase vs Frequency**

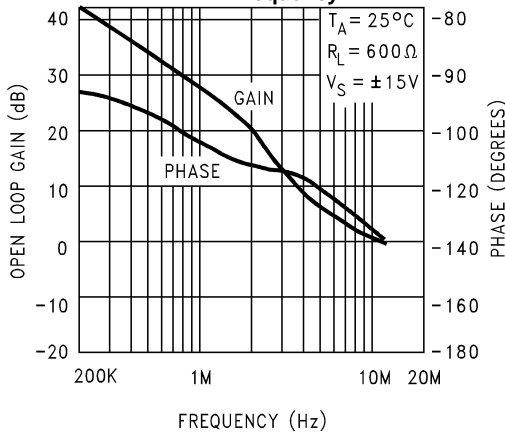


Figure 20.

**Total Harmonic Distortion vs Frequency**

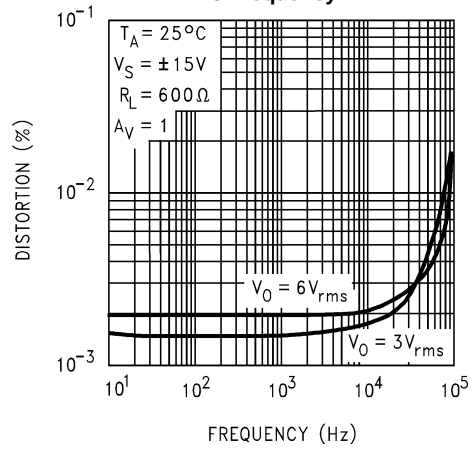


Figure 21.

**Equivalent Input Noise Voltage vs Frequency**

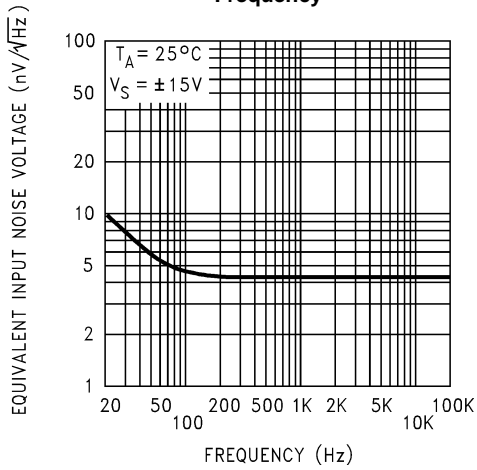


Figure 22.

**Equivalent Input Noise Current vs Frequency**

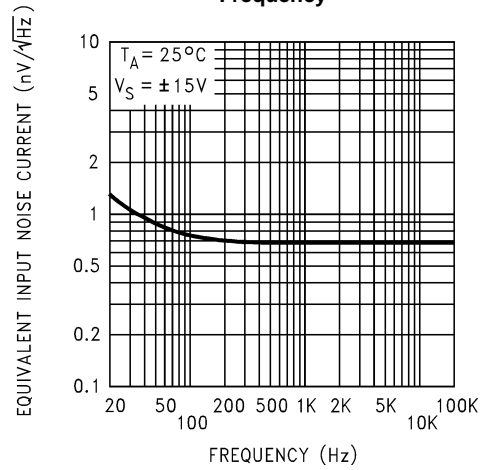


Figure 23.

**Small Signal, Non-Inverting**  
 $T_A = 25^\circ\text{C}$ ,  $A_V = 1$ ,  $R_L = 600\Omega$ ,  $V_S = \pm 15\text{V}$

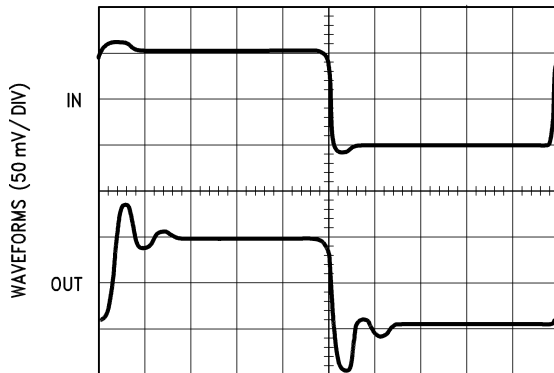


Figure 24.

**Current Limit**  
 $T_A = 25^\circ\text{C}$ ,  $V_S = \pm 15\text{V}$ ,  $R_L = 100\Omega$ ,  $A_V = 1$

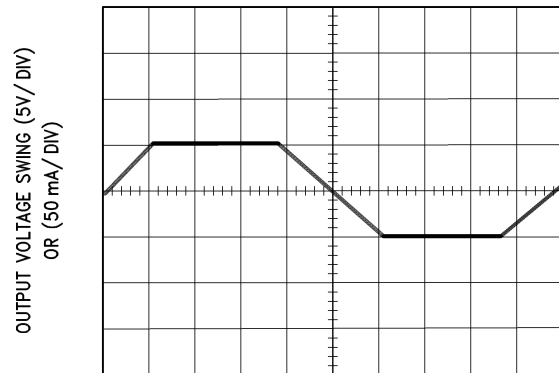
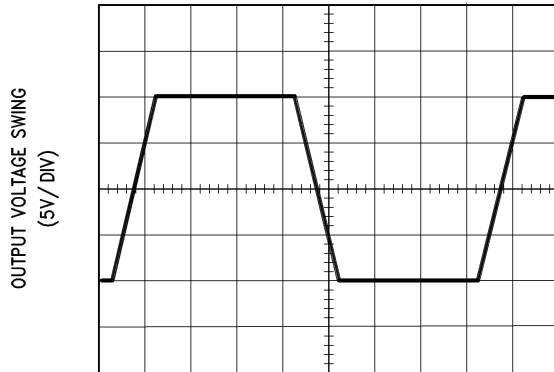


Figure 25.



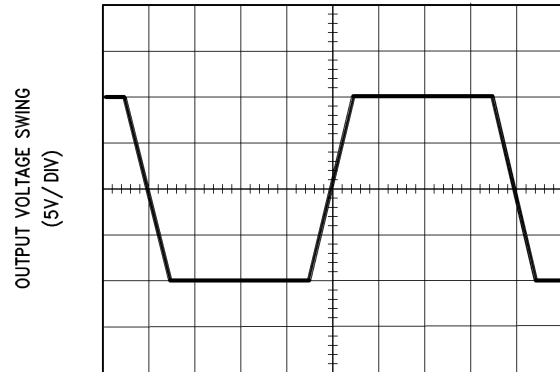
**TYPICAL PERFORMANCE CHARACTERISTICS (continued)**

**Large Signal Non-Inverting**  
 $T_A = 25^\circ\text{C}$ ,  $R_L = 600\Omega$ ,  $V_S = \pm 15\text{V}$



TIME ( $1 \mu\text{s} / \text{DIV}$ )  
**Figure 26.**

**Large Signal Inverting**  
 $T_A = 25^\circ\text{C}$ ,  $R_L = 600\Omega$ ,  $V_S = \pm 15\text{V}$



TIME ( $1 \mu\text{s} / \text{DIV}$ )  
**Figure 27.**

## REVISION HISTORY

Changes from Revision B (March 2013) to Revision C	Page
• Changed layout of National Data Sheet to TI format .....	<a href="#">5</a>

**PACKAGING INFORMATION**

Orderable Device	Status (1)	Package Type	Package Drawing	Pins	Package Qty	Eco Plan (2)	Lead/Ball Finish	MSL Peak Temp (3)	Op Temp (°C)	Top-Side Markings (4)	Samples
LM837M	ACTIVE	SOIC	D	14	55	TBD	Call TI	Call TI	-40 to 85	LM837M	<a href="#">Samples</a>
LM837M/NOPB	ACTIVE	SOIC	D	14	55	Green (RoHS & no Sb/Br)	CU SN	Level-1-260C-UNLIM	-40 to 85	LM837M	<a href="#">Samples</a>
LM837MX	ACTIVE	SOIC	D	14	2500	TBD	Call TI	Call TI	-40 to 85	LM837M	<a href="#">Samples</a>
LM837MX/NOPB	ACTIVE	SOIC	D	14	2500	Green (RoHS & no Sb/Br)	CU SN	Level-1-260C-UNLIM	-40 to 85	LM837M	<a href="#">Samples</a>

(1) The marketing status values are defined as follows:

**ACTIVE:** Product device recommended for new designs.

**LIFEBUY:** TI has announced that the device will be discontinued, and a lifetime-buy period is in effect.

**NRND:** Not recommended for new designs. Device is in production to support existing customers, but TI does not recommend using this part in a new design.

**PREVIEW:** Device has been announced but is not in production. Samples may or may not be available.

**OBSOLETE:** TI has discontinued the production of the device.

(2) Eco Plan - The planned eco-friendly classification: Pb-Free (RoHS), Pb-Free (RoHS Exempt), or Green (RoHS & no Sb/Br) - please check <http://www.ti.com/productcontent> for the latest availability information and additional product content details.

**TBD:** The Pb-Free/Green conversion plan has not been defined.

**Pb-Free (RoHS):** TI's terms "Lead-Free" or "Pb-Free" mean semiconductor products that are compatible with the current RoHS requirements for all 6 substances, including the requirement that lead not exceed 0.1% by weight in homogeneous materials. Where designed to be soldered at high temperatures, TI Pb-Free products are suitable for use in specified lead-free processes.

**Pb-Free (RoHS Exempt):** This component has a RoHS exemption for either 1) lead-based flip-chip solder bumps used between the die and package, or 2) lead-based die adhesive used between the die and leadframe. The component is otherwise considered Pb-Free (RoHS compatible) as defined above.

**Green (RoHS & no Sb/Br):** TI defines "Green" to mean Pb-Free (RoHS compatible), and free of Bromine (Br) and Antimony (Sb) based flame retardants (Br or Sb do not exceed 0.1% by weight in homogeneous material)

(3) MSL, Peak Temp. -- The Moisture Sensitivity Level rating according to the JEDEC industry standard classifications, and peak solder temperature.

(4) Multiple Top-Side Markings will be inside parentheses. Only one Top-Side Marking contained in parentheses and separated by a "~" will appear on a device. If a line is indented then it is a continuation of the previous line and the two combined represent the entire Top-Side Marking for that device.

**Important Information and Disclaimer:** The information provided on this page represents TI's knowledge and belief as of the date that it is provided. TI bases its knowledge and belief on information provided by third parties, and makes no representation or warranty as to the accuracy of such information. Efforts are underway to better integrate information from third parties. TI has taken and continues to take reasonable steps to provide representative and accurate information but may not have conducted destructive testing or chemical analysis on incoming materials and chemicals. TI and TI suppliers consider certain information to be proprietary, and thus CAS numbers and other limited information may not be available for release.

In no event shall TI's liability arising out of such information exceed the total purchase price of the TI part(s) at issue in this document sold by TI to Customer on an annual basis.



**TAPE AND REEL INFORMATION**

**QUADRANT ASSIGNMENTS FOR PIN 1 ORIENTATION IN TAPE**


\*All dimensions are nominal

Device	Package Type	Package Drawing	Pins	SPQ	Reel Diameter (mm)	Reel Width W1 (mm)	A0 (mm)	B0 (mm)	K0 (mm)	P1 (mm)	W (mm)	Pin1 Quadrant
LM837MX	SOIC	D	14	2500	330.0	16.4	6.5	9.35	2.3	8.0	16.0	Q1
LM837MX/NOPB	SOIC	D	14	2500	330.0	16.4	6.5	9.35	2.3	8.0	16.0	Q1

**TAPE AND REEL BOX DIMENSIONS**


\*All dimensions are nominal

Device	Package Type	Package Drawing	Pins	SPQ	Length (mm)	Width (mm)	Height (mm)
LM837MX	SOIC	D	14	2500	367.0	367.0	35.0
LM837MX/NOPB	SOIC	D	14	2500	367.0	367.0	35.0

D (R-PDSO-G14)

PLASTIC SMALL OUTLINE



- NOTES:
- A. All linear dimensions are in inches (millimeters).
  - B. This drawing is subject to change without notice.
  - Body length does not include mold flash, protrusions, or gate burrs. Mold flash, protrusions, or gate burrs shall not exceed 0.006 (0,15) each side.
  - Body width does not include interlead flash. Interlead flash shall not exceed 0.017 (0,43) each side.
  - E. Reference JEDEC MS-012 variation AB.

## IMPORTANT NOTICE

Texas Instruments Incorporated and its subsidiaries (TI) reserve the right to make corrections, enhancements, improvements and other changes to its semiconductor products and services per JESD46, latest issue, and to discontinue any product or service per JESD48, latest issue. Buyers should obtain the latest relevant information before placing orders and should verify that such information is current and complete. All semiconductor products (also referred to herein as "components") are sold subject to TI's terms and conditions of sale supplied at the time of order acknowledgment.

TI warrants performance of its components to the specifications applicable at the time of sale, in accordance with the warranty in TI's terms and conditions of sale of semiconductor products. Testing and other quality control techniques are used to the extent TI deems necessary to support this warranty. Except where mandated by applicable law, testing of all parameters of each component is not necessarily performed.

TI assumes no liability for applications assistance or the design of Buyers' products. Buyers are responsible for their products and applications using TI components. To minimize the risks associated with Buyers' products and applications, Buyers should provide adequate design and operating safeguards.

TI does not warrant or represent that any license, either express or implied, is granted under any patent right, copyright, mask work right, or other intellectual property right relating to any combination, machine, or process in which TI components or services are used. Information published by TI regarding third-party products or services does not constitute a license to use such products or services or a warranty or endorsement thereof. Use of such information may require a license from a third party under the patents or other intellectual property of the third party, or a license from TI under the patents or other intellectual property of TI.

Reproduction of significant portions of TI information in TI data books or data sheets is permissible only if reproduction is without alteration and is accompanied by all associated warranties, conditions, limitations, and notices. TI is not responsible or liable for such altered documentation. Information of third parties may be subject to additional restrictions.

Resale of TI components or services with statements different from or beyond the parameters stated by TI for that component or service voids all express and any implied warranties for the associated TI component or service and is an unfair and deceptive business practice. TI is not responsible or liable for any such statements.

Buyer acknowledges and agrees that it is solely responsible for compliance with all legal, regulatory and safety-related requirements concerning its products, and any use of TI components in its applications, notwithstanding any applications-related information or support that may be provided by TI. Buyer represents and agrees that it has all the necessary expertise to create and implement safeguards which anticipate dangerous consequences of failures, monitor failures and their consequences, lessen the likelihood of failures that might cause harm and take appropriate remedial actions. Buyer will fully indemnify TI and its representatives against any damages arising out of the use of any TI components in safety-critical applications.

In some cases, TI components may be promoted specifically to facilitate safety-related applications. With such components, TI's goal is to help enable customers to design and create their own end-product solutions that meet applicable functional safety standards and requirements. Nonetheless, such components are subject to these terms.

No TI components are authorized for use in FDA Class III (or similar life-critical medical equipment) unless authorized officers of the parties have executed a special agreement specifically governing such use.

Only those TI components which TI has specifically designated as military grade or "enhanced plastic" are designed and intended for use in military/aerospace applications or environments. Buyer acknowledges and agrees that any military or aerospace use of TI components which have **not** been so designated is solely at the Buyer's risk, and that Buyer is solely responsible for compliance with all legal and regulatory requirements in connection with such use.

TI has specifically designated certain components as meeting ISO/TS16949 requirements, mainly for automotive use. In any case of use of non-designated products, TI will not be responsible for any failure to meet ISO/TS16949.

### Products

Audio	<a href="http://www.ti.com/audio">www.ti.com/audio</a>
Amplifiers	<a href="http://amplifier.ti.com">amplifier.ti.com</a>
Data Converters	<a href="http://dataconverter.ti.com">dataconverter.ti.com</a>
DLP® Products	<a href="http://www.dlp.com">www.dlp.com</a>
DSP	<a href="http://dsp.ti.com">dsp.ti.com</a>
Clocks and Timers	<a href="http://www.ti.com/clocks">www.ti.com/clocks</a>
Interface	<a href="http://interface.ti.com">interface.ti.com</a>
Logic	<a href="http://logic.ti.com">logic.ti.com</a>
Power Mgmt	<a href="http://power.ti.com">power.ti.com</a>
Microcontrollers	<a href="http://microcontroller.ti.com">microcontroller.ti.com</a>
RFID	<a href="http://www.ti-rfid.com">www.ti-rfid.com</a>
OMAP Applications Processors	<a href="http://www.ti.com/omap">www.ti.com/omap</a>
Wireless Connectivity	<a href="http://www.ti.com/wirelessconnectivity">www.ti.com/wirelessconnectivity</a>

### Applications

Automotive and Transportation	<a href="http://www.ti.com/automotive">www.ti.com/automotive</a>
Communications and Telecom	<a href="http://www.ti.com/communications">www.ti.com/communications</a>
Computers and Peripherals	<a href="http://www.ti.com/computers">www.ti.com/computers</a>
Consumer Electronics	<a href="http://www.ti.com/consumer-apps">www.ti.com/consumer-apps</a>
Energy and Lighting	<a href="http://www.ti.com/energy">www.ti.com/energy</a>
Industrial	<a href="http://www.ti.com/industrial">www.ti.com/industrial</a>
Medical	<a href="http://www.ti.com/medical">www.ti.com/medical</a>
Security	<a href="http://www.ti.com/security">www.ti.com/security</a>
Space, Avionics and Defense	<a href="http://www.ti.com/space-avionics-defense">www.ti.com/space-avionics-defense</a>
Video and Imaging	<a href="http://www.ti.com/video">www.ti.com/video</a>

### TI E2E Community

[e2e.ti.com](http://e2e.ti.com)