

LMV321 SINGLE, LMV358 DUAL, LMV324 QUAD, LMV324S QUAD WITH SHUTDOWN LOW-VOLTAGE RAIL-TO-RAIL OUTPUT OPERATIONAL AMPLIFIERS

SLOS263Q – AUGUST 1999 – REVISED OCTOBER 2004

- **2.7-V and 5-V Performance**
- **-40°C to 125°C Operation**
- **Low-Power Shutdown Mode (LMV324S)**
- **No Crossover Distortion**
- **Low Supply Current**
 - LMV321 . . . 130 μ A Typ
 - LMV358 . . . 210 μ A Typ
 - LMV324 . . . 410 μ A Typ
 - LMV324S . . . 410 μ A Typ
- **Rail-to-Rail Output Swing**
- **ESD Protection Exceeds JESD 22**
 - 2000-V Human-Body Model (A114-A)
 - 1000-V Charged-Device Model (C101)

description/ordering information

The LMV321, LMV358, and LMV324/LMV324S are single, dual, and quad low-voltage (2.7 V to 5.5 V), operational amplifiers with rail-to-rail output swing. The LMV324S, which is a variation of the standard LMV324, includes a power-saving shutdown feature that reduces supply current to a maximum of 5 μ A per channel when the amplifiers are not needed. Channels 1 and 2 together are put in shutdown, as are channels 3 and 4. While in shutdown, the outputs actively are pulled low.

The LMV321, LMV358, LMV324, and LMV324S are the most cost-effective solutions for applications where low-voltage operation, space saving, and low cost are needed. These amplifiers were designed specifically for low-voltage (2.7 V to 5 V) operation, with performance specifications meeting or exceeding the LM358 and LM324 devices that operate from 5 V to 30 V. Additional features of the LMV3xx devices are a common-mode input voltage range that includes ground, 1-MHz unity-gain bandwidth, and 1-V/ μ s slew rate.

The LMV321 is available in the ultra-small DCK (SC-70) package, which is approximately one-half the size of the DBV (SOT-23) package. This package saves space on printed circuit boards and enables the design of small portable electronic devices. It also allows the designer to place the device closer to the signal source to reduce noise pickup and increase signal integrity.

LMV324 . . . D (SOIC) OR PW (TSSOP) PACKAGE
(TOP VIEW)

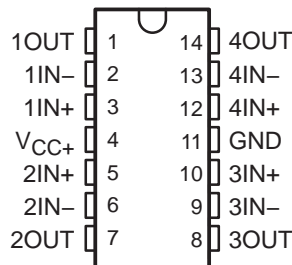

LMV324S . . . D (SOIC) OR PW (TSSOP) PACKAGE
(TOP VIEW)

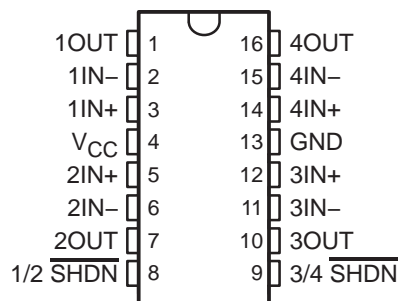

LMV358 . . . D (SOIC), DDU (VSSOP),
DGK (MSOP), OR PW (TSSOP) PACKAGE
(TOP VIEW)

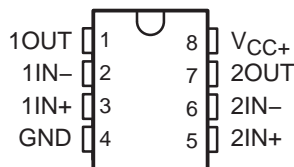

LMV321 . . . DBV (SOT-23) OR DCK (SC-70) PACKAGE
(TOP VIEW)

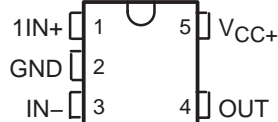

LMV321 SINGLE, LMV358 DUAL, LMV324 QUAD, LMV324S QUAD WITH SHUTDOWN LOW-VOLTAGE RAIL-TO-RAIL OUTPUT OPERATIONAL AMPLIFIERS

SLOS263Q – AUGUST 1999 – REVISED OCTOBER 2004

ORDERING INFORMATION

T _A		PACKAGE†		ORDERABLE PART NUMBER	TOP-SIDE MARKING‡
-40°C to 85°C	Single	SC-70 (DCK)	Reel of 3000	LMV321IDCKR	R3_
			Reel of 250	LMV321IDCKT	
		SOT23-5 (DBV)	Reel of 3000	LMV321IDBVR	RC1_
			Reel of 250	LMV321IDBVT	
	Dual	MSOP/VSSOP (DGK)	Reel of 2500	LMV358IDGKR	R5_
			Reel of 250	LMV358IDGKT	PREVIEW
		SOIC (D)	Tube of 75	LMV358ID	MV358I
			Reel of 2500	LMV358IDR	
		TSSOP (PW)	Tube of 150	LMV358IPW	MV358I
			Reel of 2000	LMV358IPWR	
	VSSOP (DDU)	Reel of 3000	LMV358IDDUR	RA56	
	Quad	SOIC (D)	Tube of 50	LMV324ID	LMV324I
			Reel of 2500	LMV324IDR	
			Tube of 40	LMV324SID	LMV324SI
Reel of 2500			LMV324SIDR		
TSSOP (PW)		Reel of 2000	LMV324IPWR	MV324I	
			LMV324SIPWR	MV324SI	
-40°C to 125°C	Dual	MSOP/VSSOP (DGK)	Reel of 2500	LMV358QDGKR	RH_
			Reel of 250	LMV358QDGKT	
		SOIC (D)	Tube of 75	LMV358QD	MV358Q
			Reel of 2500	LMV358QDR	
	TSSOP (PW)	Tube of 150	LMV358QPW	MV358Q	
		Reel of 2000	LMV358QPWR		
	VSSOP (DDU)	Reel of 3000	LMV358QDDUR	RAH_	
	Quad	SOIC (D)	Tube of 50	LMV324QD	LMV324Q
			Reel of 2500	LMV324QDR	
		TSSOP (PW)	Tube of 90	LMV324QPW	MV324Q
Reel of 2000			LMV324QPWR		

† Package drawings, standard packing quantities, thermal data, symbolization, and PCB design guidelines are available at www.ti.com/sc/package.

‡ DBV/DCK/DGK: The actual top-side marking has one additional character that designates the assembly/test site.

symbol (each amplifier)

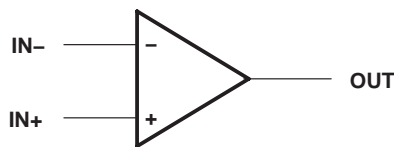

LMV321 SINGLE, LMV358 DUAL, LMV324 QUAD, LMV324S QUAD WITH SHUTDOWN LOW-VOLTAGE RAIL-TO-RAIL OUTPUT OPERATIONAL AMPLIFIERS

SLOS263Q – AUGUST 1999 – REVISED OCTOBER 2004

LMV324 simplified schematic

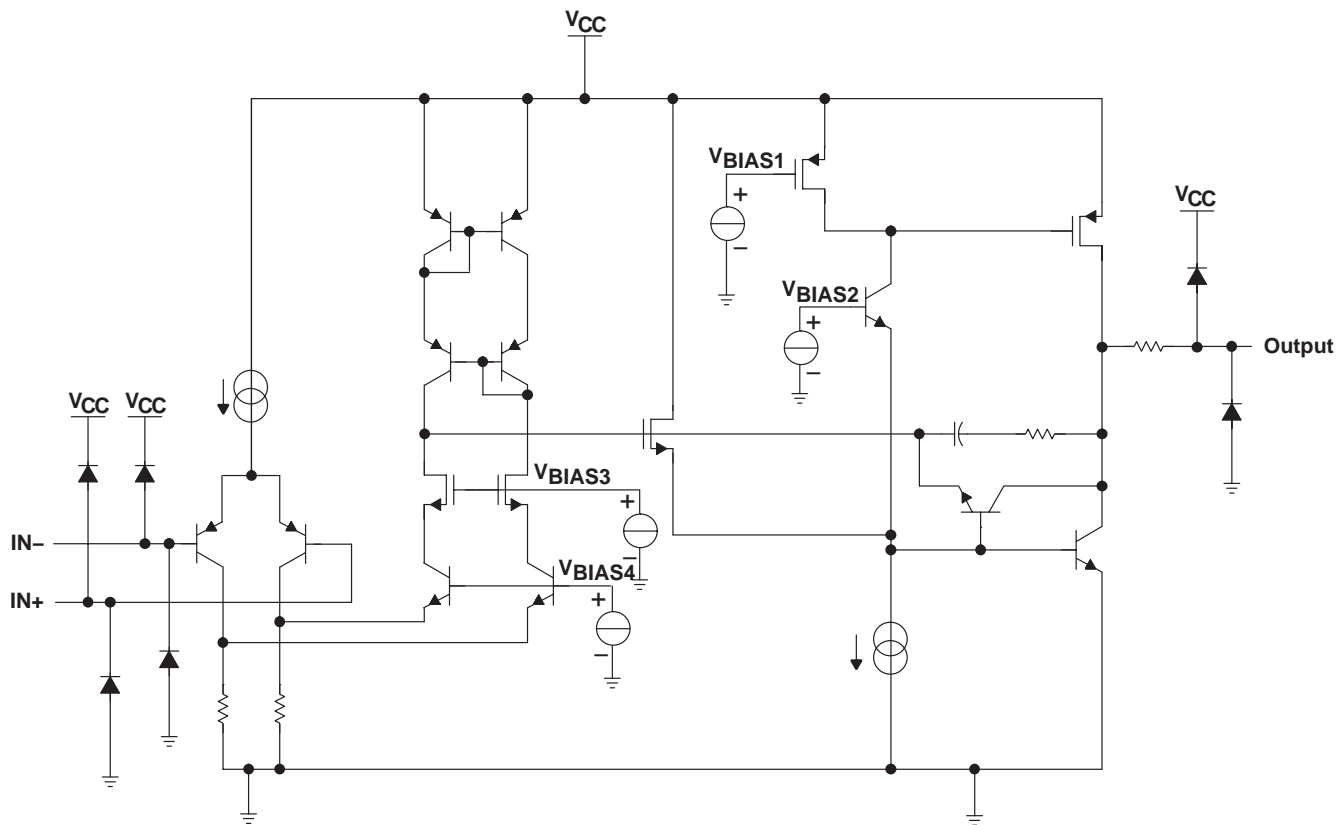

LMV321 SINGLE, LMV358 DUAL, LMV324 QUAD, LMV324S QUAD WITH SHUTDOWN LOW-VOLTAGE RAIL-TO-RAIL OUTPUT OPERATIONAL AMPLIFIERS

SLOS263Q – AUGUST 1999 – REVISED OCTOBER 2004

absolute maximum ratings over operating free-air temperature range (unless otherwise noted)†

Supply voltage, V_{CC} (see Note 1)	5.5 V
Differential input voltage, V_{ID} (see Note 2)	± 5.5 V
Input voltage, V_I (either input)	0 to 5.5 V
Duration of output short circuit (one amplifier) to ground at (or below) $T_A = 25^\circ\text{C}$, $V_{CC} \leq 5.5$ V (see Note 3)	Unlimited
Package thermal impedance, θ_{JA} (see Notes 4 and 5):	
D (8-pin) package	97°C/W
D (14-pin) package	86°C/W
D (16-pin) package	73°C/W
DBV (5-pin) package	206°C/W
DCK (5-pin) package	252°C/W
DDU (8-pin) package	TBD°C/W
DGK (8-pin) package	172°C/W
PW (8-pin) package	149°C/W
PW (14-pin) package	113°C/W
PW (16-pin) package	108°C/W
Operating virtual junction temperature, T_J	150°C
Storage temperature range, T_{stg}	-65°C to 150°C

† Stresses beyond those listed under “absolute maximum ratings” may cause permanent damage to the device. These are stress ratings only, and functional operation of the device at these or any other conditions beyond those indicated under “recommended operating conditions” is not implied. Exposure to absolute-maximum-rated conditions for extended periods may affect device reliability.

- NOTES:
1. All voltage values (except differential voltages and V_{CC} specified for the measurement of I_{OS}) are with respect to the network GND.
 2. Differential voltages are at $IN+$ with respect to $IN-$.
 3. Short circuits from outputs to V_{CC} can cause excessive heating and eventual destruction.
 4. Maximum power dissipation is a function of $T_J(\text{max})$, θ_{JA} , and T_A . The maximum allowable power dissipation at any allowable ambient temperature is $P_D = (T_J(\text{max}) - T_A)/\theta_{JA}$. Selecting the maximum of 150°C can affect reliability.
 5. The package thermal impedance is calculated in accordance with JESD 51-7.

recommended operating conditions (see Note 6)

		MIN	MAX	UNIT	
V_{CC}	Supply voltage (single-supply operation)	2.7	5.5	V	
V_{IH}	Amplifier turnon voltage level (LMV324S)‡	$V_{CC} = 2.7$ V	1.7	V	
		$V_{CC} = 5$ V	3.5		
V_{IL}	Amplifier turnoff voltage level (LMV324S)	$V_{CC} = 2.7$ V	0.7	V	
		$V_{CC} = 5$ V	1.5		
T_A	Operating free-air temperature	I-Temp	-40	85	°C
		Q-Temp	-40	125	

‡ V_{IH} should not be allowed to exceed V_{CC} .

NOTE 6: All unused control inputs of the device must be held at V_{CC} or GND to ensure proper device operation. Refer to the TI application report, *Implications of Slow or Floating CMOS Inputs*, literature number SCBA004.



LMV321 SINGLE, LMV358 DUAL, LMV324 QUAD, LMV324S QUAD WITH SHUTDOWN LOW-VOLTAGE RAIL-TO-RAIL OUTPUT OPERATIONAL AMPLIFIERS

SLOS263Q – AUGUST 1999 – REVISED OCTOBER 2004

electrical characteristics at $T_A = 25^\circ\text{C}$ and $V_{CC+} = 2.7\text{ V}$ (unless otherwise noted)

PARAMETER		TEST CONDITIONS	MIN	TYP	MAX	UNIT
V_{IO}	Input offset voltage			1.7	7	mV
$\alpha_{V_{IO}}$	Average temperature coefficient of input offset voltage			5		$\mu\text{V}/^\circ\text{C}$
I_{IB}	Input bias current			11	250	nA
I_{IO}	Input offset current			5	50	nA
CMRR	Common-mode rejection ratio	$V_{CM} = 0$ to 1.7 V	50	63		dB
k_{SVR}	Supply-voltage rejection ratio	$V_{CC} = 2.7\text{ V}$ to 5 V, $V_O = 1\text{ V}$	50	60		dB
V_{ICR}	Common-mode input voltage range	CMRR ≥ 50 dB	0 to 1.7	-0.2 to 1.9		V
	Output swing	$R_L = 10\text{ k}\Omega$ to 1.35 V	High level $V_{CC} - 100$	$V_{CC} - 10$		mV
			Low level	60	180	
I_{CC}	Supply current	LMV321I		80	170	μA
		LMV358I (both amplifiers)		140	340	
		LMV324I/LMV324SI (all four amplifiers)		260	680	
B_1	Unity-gain bandwidth	$C_L = 200\text{ pF}$		1		MHz
Φ_m	Phase margin			60		deg
G_m	Gain margin			10		dB
V_n	Equivalent input noise voltage	$f = 1\text{ kHz}$		46		$\text{nV}/\sqrt{\text{Hz}}$
I_n	Equivalent input noise current	$f = 1\text{ kHz}$		0.17		$\text{pA}/\sqrt{\text{Hz}}$

shutdown characteristics (LMV324S) at $T_A = 25^\circ\text{C}$ and $V_{CC+} = 2.7\text{ V}$ (unless otherwise noted)

PARAMETER		TEST CONDITIONS	MIN	TYP	MAX	UNIT
$I_{CC(\text{SHDN})}$	Supply current in shutdown mode (per channel)	$\overline{\text{SHDN}} \leq 0.6\text{ V}$			5	μA
$t_{(\text{on})}$	Amplifier turnon time	$A_V = 1$, $R_L = \text{Open}$ (measured at 50% point)		2		μs
$t_{(\text{off})}$	Amplifier turnoff time	$A_V = 1$, $R_L = \text{Open}$ (measured at 50% point)		40		ns



LMV321 SINGLE, LMV358 DUAL, LMV324 QUAD, LMV324S QUAD WITH SHUTDOWN LOW-VOLTAGE RAIL-TO-RAIL OUTPUT OPERATIONAL AMPLIFIERS

SLOS263Q – AUGUST 1999 – REVISED OCTOBER 2004

electrical characteristics at specified free-air temperature range, $V_{CC+} = 5\text{ V}$ (unless otherwise noted)

PARAMETER		TEST CONDITIONS	T_A^\dagger	MIN	TYP	MAX	UNIT	
V_{IO}	Input offset voltage		25°C		1.7	7	mV	
			Full range			9		
$\alpha_{V_{IO}}$	Average temperature coefficient of input offset voltage		25°C		5		$\mu\text{V}/^\circ\text{C}$	
I_{IB}	Input bias current		25°C		15	250	nA	
			Full range			500		
I_{IO}	Input offset current		25°C		5	50	nA	
			Full range			150		
CMRR	Common-mode rejection ratio	$V_{CM} = 0\text{ to }4\text{ V}$	25°C	50	65		dB	
k_{SVR}	Supply-voltage rejection ratio	$V_{CC} = 2.7\text{ V to }5\text{ V}$, $V_O = 1\text{ V}$, $V_{CM} = 1\text{ V}$	25°C	50	60		dB	
V_{ICR}	Common-mode input voltage range	$CMMR \geq 50\text{ dB}$	25°C	0 to 4	-0.2 to 4.2		V	
Output swing		$R_L = 2\text{ k}\Omega\text{ to }2.5\text{ V}$	High level	25°C	$V_{CC} - 300$	$V_{CC} - 40$	mV	
				Full range	$V_{CC} - 400$			
			Low level	25°C		120		300
				Full range				400
		$R_L = 10\text{ k}\Omega\text{ to }2.5\text{ V}$	High level	25°C	$V_{CC} - 100$	$V_{CC} - 10$		
				Full range	$V_{CC} - 200$			
			Low level	25°C		65		180
				Full range				280
A_{VD}	Large-signal differential voltage gain	$R_L = 2\text{ k}\Omega$	25°C	15	100	V/mV		
			Full range	10				
I_{OS}	Output short-circuit current	Sourcing, $V_O = 0\text{ V}$	25°C	5	60	mA		
		Sinking, $V_O = 5\text{ V}$		10	160			
I_{CC}	Supply current	LMV321I	25°C		130	250	μA	
			Full range			350		
		LMV358I (both amplifiers)	25°C		210	440		
			Full range			615		
		LMV324I/LMV324SI (all four amplifiers)	25°C		410	830		
			Full range			1160		
B_1	Unity-gain bandwidth	$C_L = 200\text{ pF}$	25°C		1	MHz		
ϕ_m	Phase margin		25°C		60	deg		
G_m	Gain margin		25°C		10	dB		
V_n	Equivalent input noise voltage	$f = 1\text{ kHz}$	25°C		39	$\text{nV}/\sqrt{\text{Hz}}$		
I_n	Equivalent input noise current	$f = 1\text{ kHz}$	25°C		0.21	$\text{pA}/\sqrt{\text{Hz}}$		
SR	Slew rate		25°C		1	$\text{V}/\mu\text{s}$		

† Full range: -40°C to 85°C for I-temp, -40°C to 125°C for Q-temp.



LMV321 SINGLE, LMV358 DUAL, LMV324 QUAD, LMV324S QUAD WITH SHUTDOWN LOW-VOLTAGE RAIL-TO-RAIL OUTPUT OPERATIONAL AMPLIFIERS

SLOS263Q – AUGUST 1999 – REVISED OCTOBER 2004

shutdown characteristics (LMV324S) at $T_A = 25^\circ\text{C}$ and $V_{CC+} = 5\text{ V}$ (unless otherwise noted)

PARAMETER		TEST CONDITIONS	T_A	MIN	TYP	MAX	UNIT
$I_{CC(SHDN)}$	Supply current in shutdown mode (per channel)	$\overline{SHDN} \leq 0.6\text{ V}$	-40°C to 85°C			5	μA
$t_{(on)}$	Amplifier turnon time	$A_V = 1, R_L = \text{Open}$ (measured at 50% point)			2		μs
$t_{(off)}$	Amplifier turnoff time	$A_V = 1, R_L = \text{Open}$ (measured at 50% point)			40		ns



LMV321 SINGLE, LMV358 DUAL, LMV324 QUAD, LMV324S QUAD WITH SHUTDOWN LOW-VOLTAGE RAIL-TO-RAIL OUTPUT OPERATIONAL AMPLIFIERS

SLOS263Q – AUGUST 1999 – REVISED OCTOBER 2004

TYPICAL CHARACTERISTICS

LMV321 FREQUENCY RESPONSE
vs
RESISTIVE LOAD

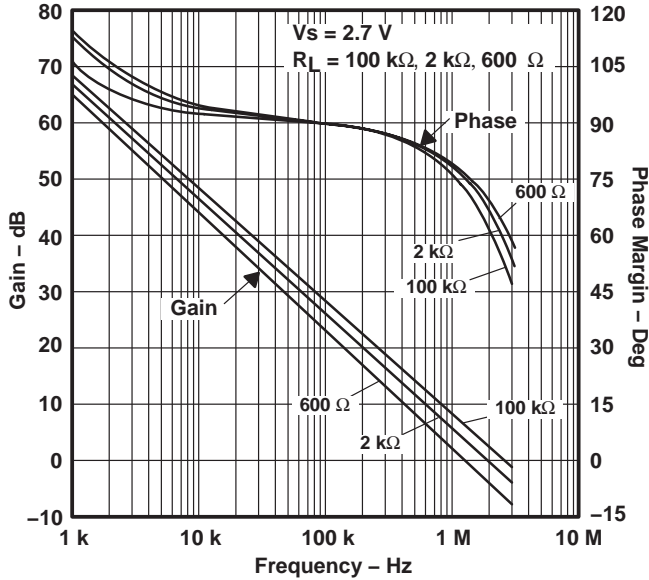

Figure 1

LMV321 FREQUENCY RESPONSE
vs
RESISTIVE LOAD

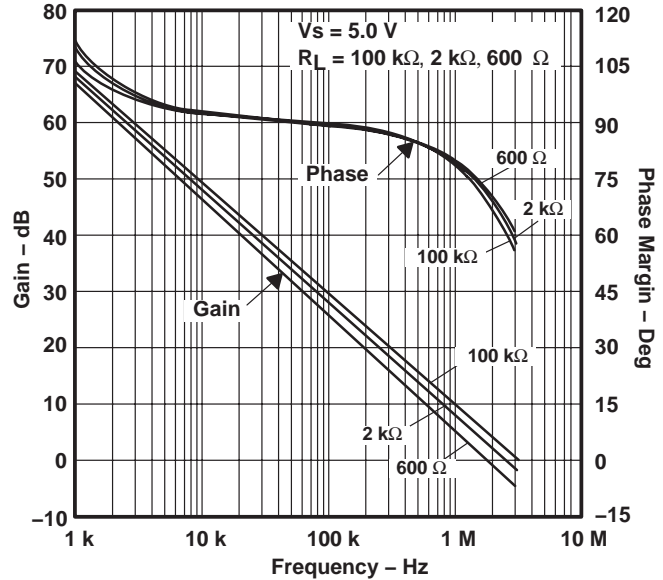

Figure 2

LMV321 FREQUENCY RESPONSE
vs
CAPACITIVE LOAD

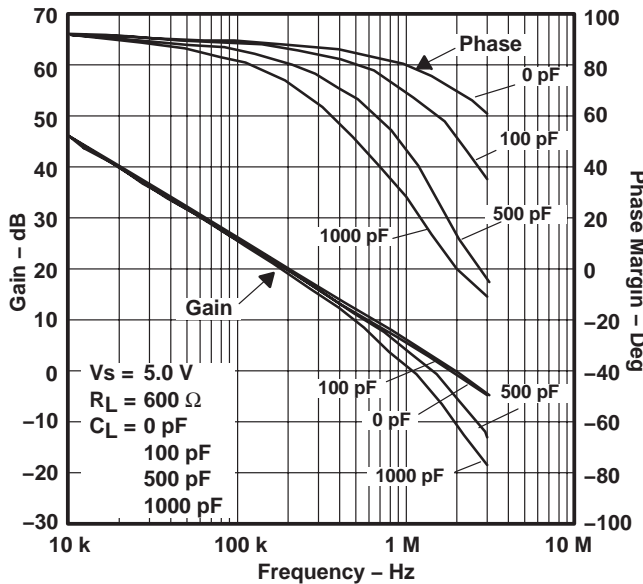

Figure 3

LMV321 FREQUENCY RESPONSE
vs
CAPACITIVE LOAD

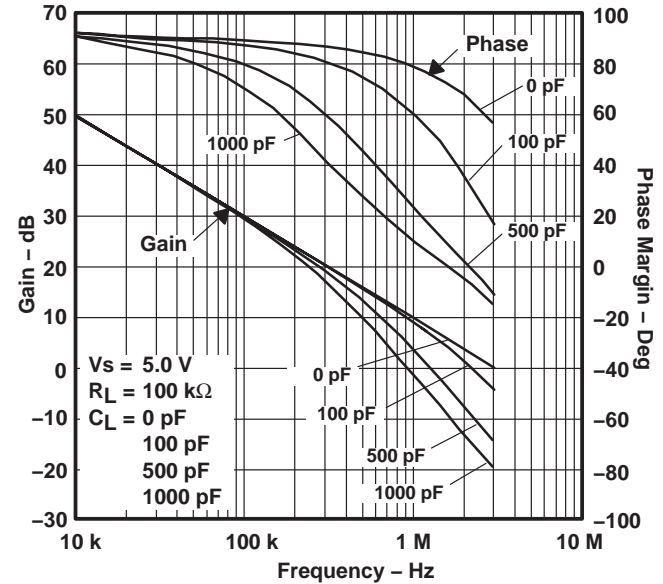

Figure 4

LMV321 SINGLE, LMV358 DUAL, LMV324 QUAD, LMV324S QUAD WITH SHUTDOWN LOW-VOLTAGE RAIL-TO-RAIL OUTPUT OPERATIONAL AMPLIFIERS

SLOS263Q – AUGUST 1999 – REVISED OCTOBER 2004

TYPICAL CHARACTERISTICS

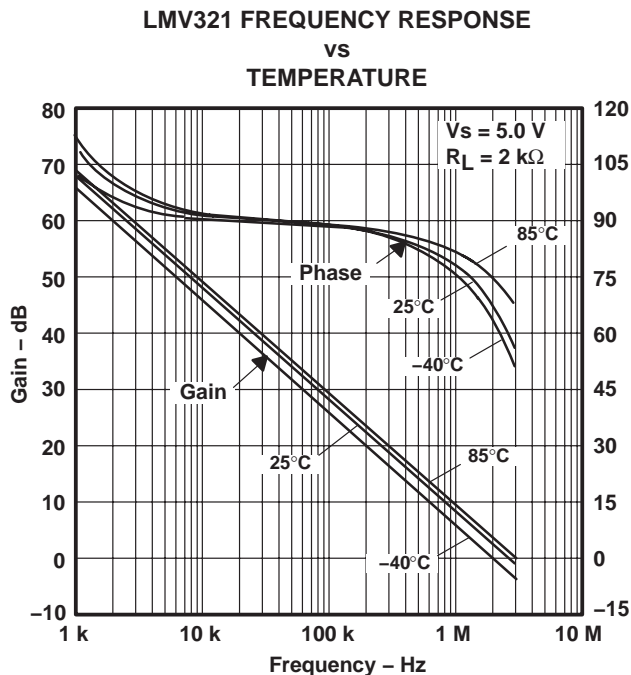

Figure 5

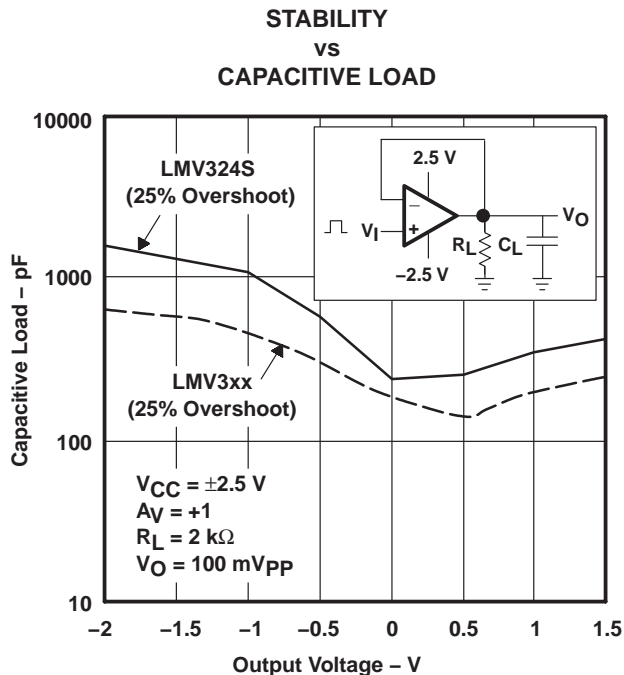

Figure 6

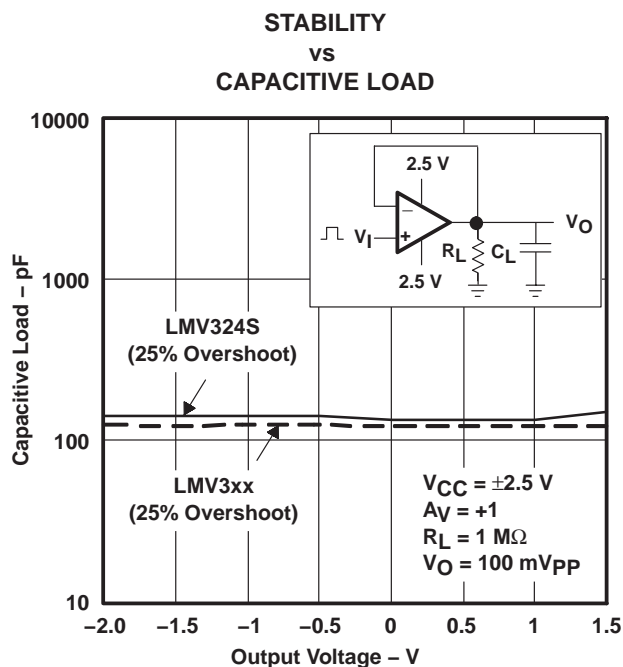

Figure 7

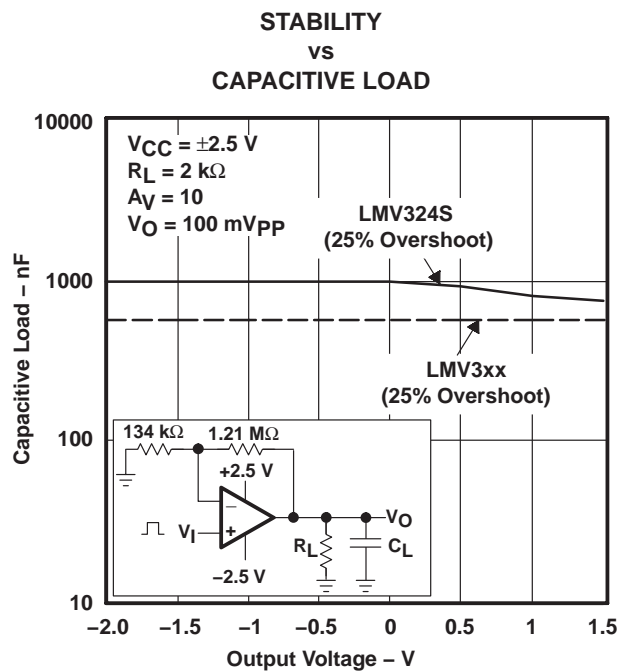

Figure 8

LMV321 SINGLE, LMV358 DUAL, LMV324 QUAD, LMV324S QUAD WITH SHUTDOWN LOW-VOLTAGE RAIL-TO-RAIL OUTPUT OPERATIONAL AMPLIFIERS

SLOS263Q – AUGUST 1999 – REVISED OCTOBER 2004

TYPICAL CHARACTERISTICS

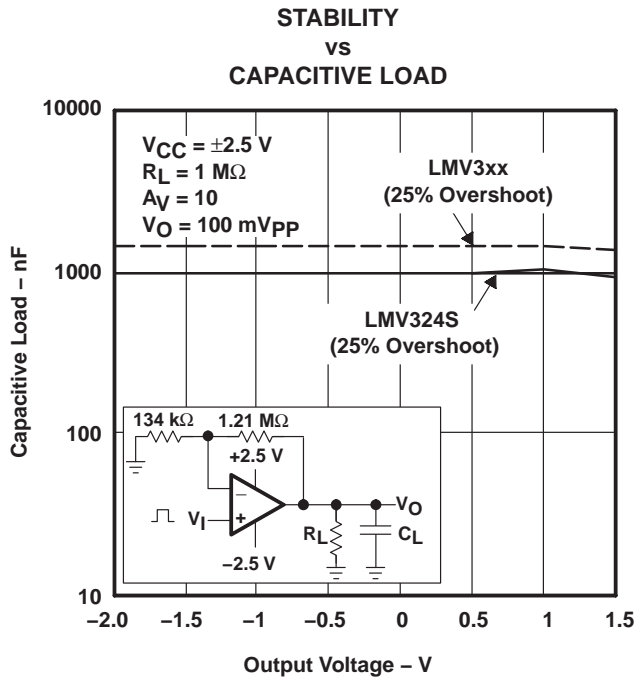

Figure 9

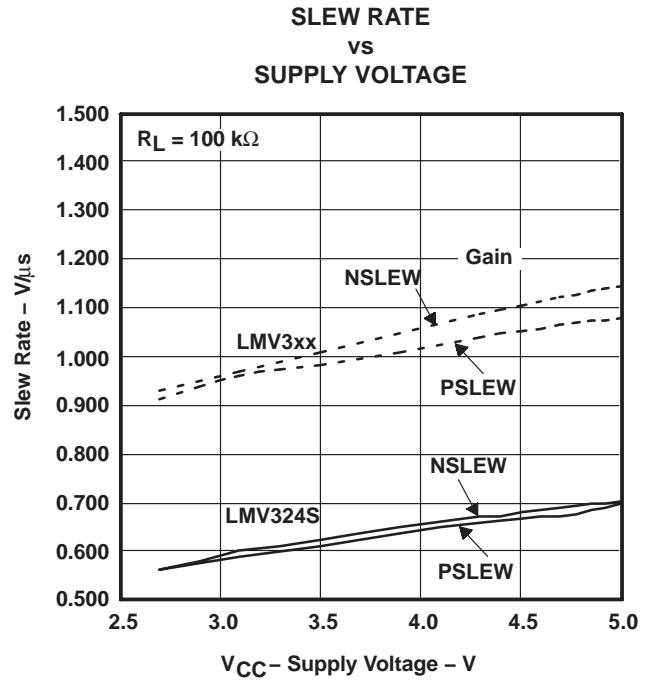

Figure 10

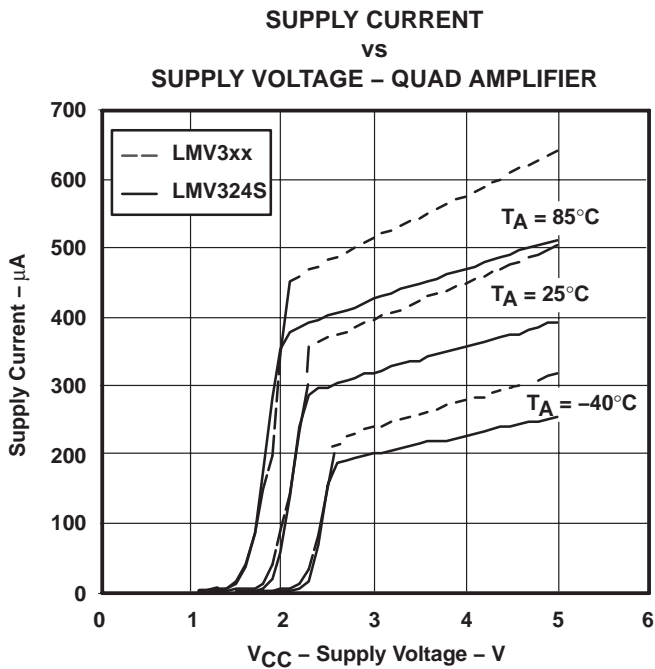

Figure 11

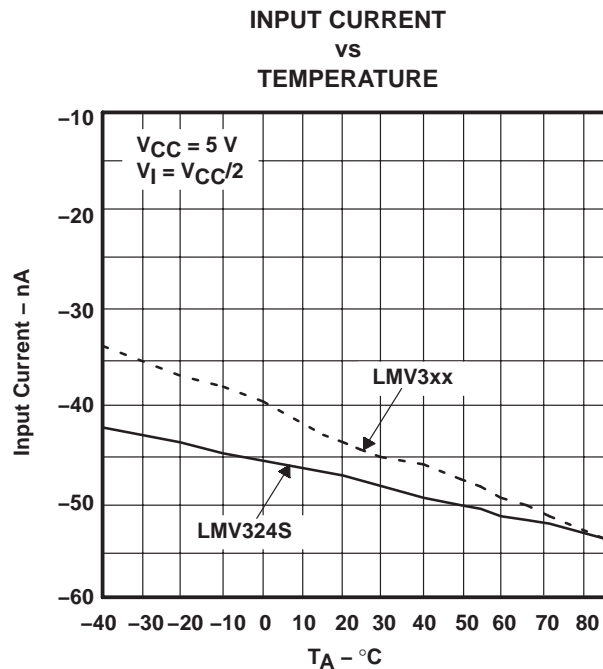
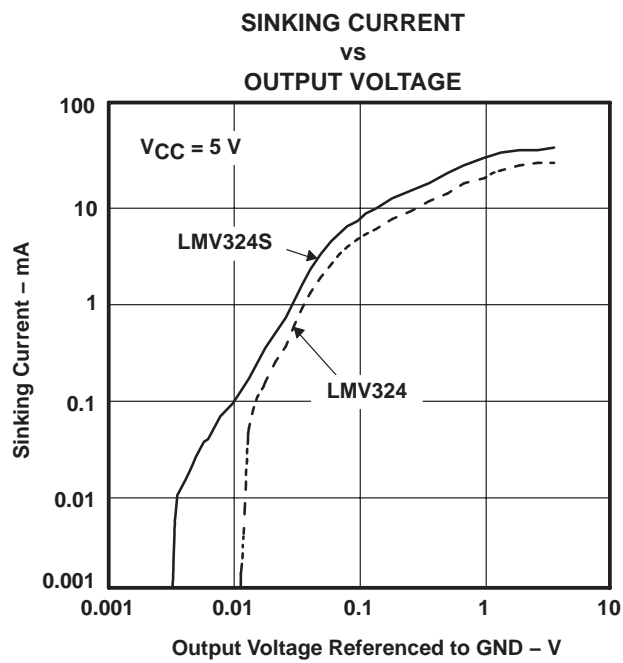
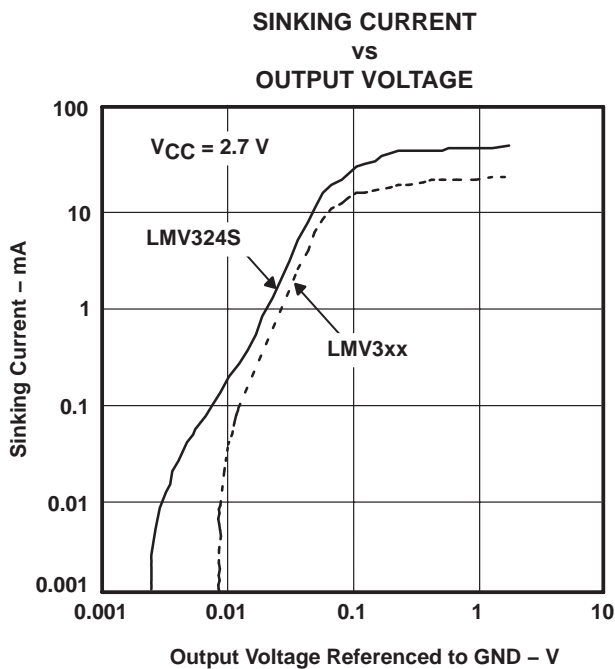
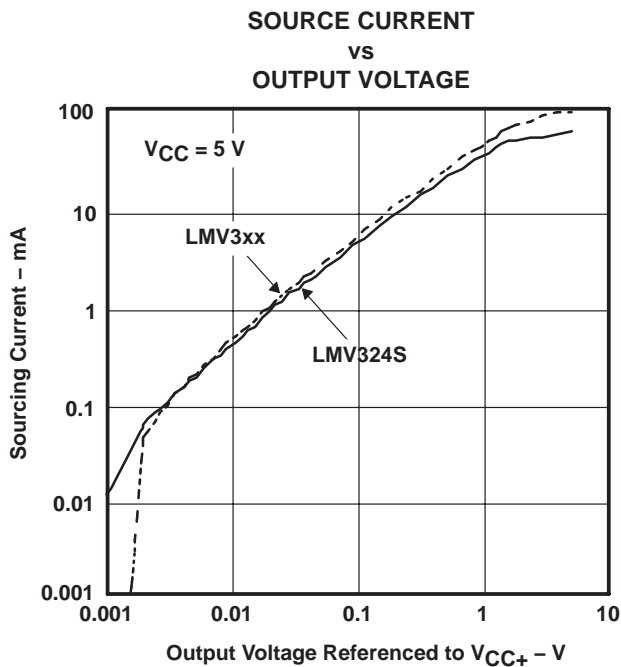
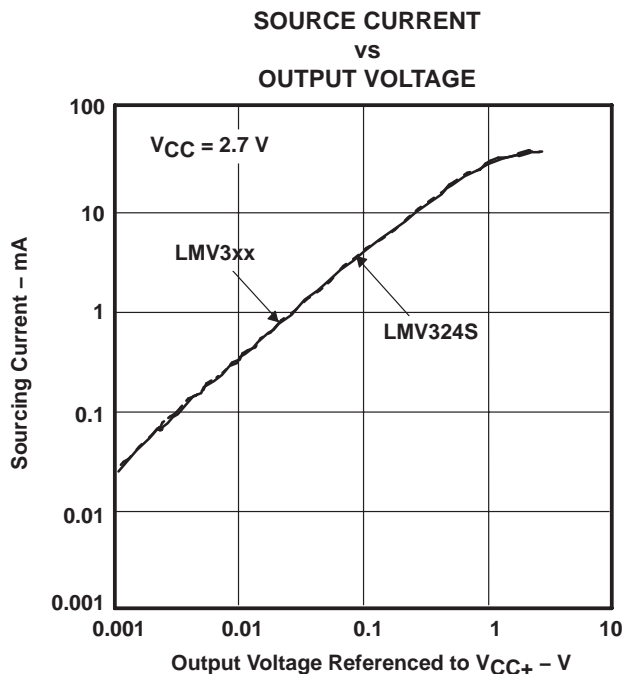

Figure 12

TYPICAL CHARACTERISTICS



LMV321 SINGLE, LMV358 DUAL, LMV324 QUAD, LMV324S QUAD WITH SHUTDOWN LOW-VOLTAGE RAIL-TO-RAIL OUTPUT OPERATIONAL AMPLIFIERS

SLOS263Q – AUGUST 1999 – REVISED OCTOBER 2004

TYPICAL CHARACTERISTICS

**SHORT-CIRCUIT CURRENT
vs
TEMPERATURE**

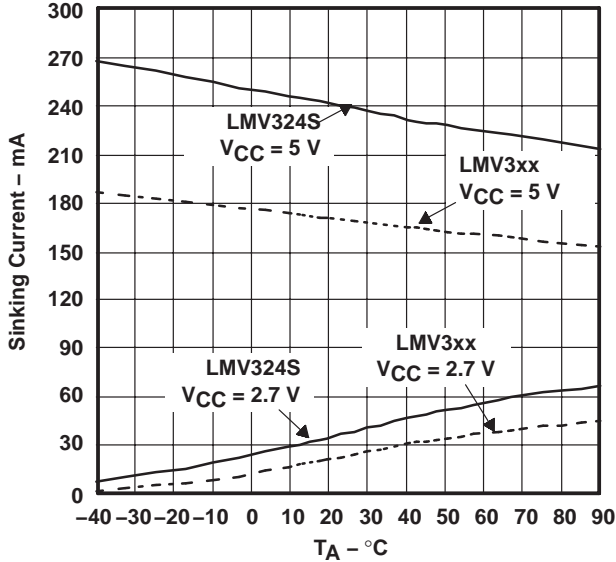

Figure 17

**SHORT-CIRCUIT CURRENT
vs
TEMPERATURE**

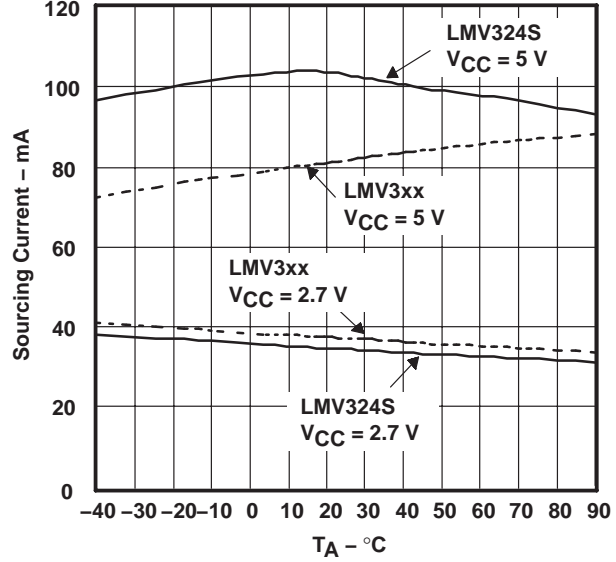

Figure 18

**-k_{SVR}
vs
FREQUENCY**

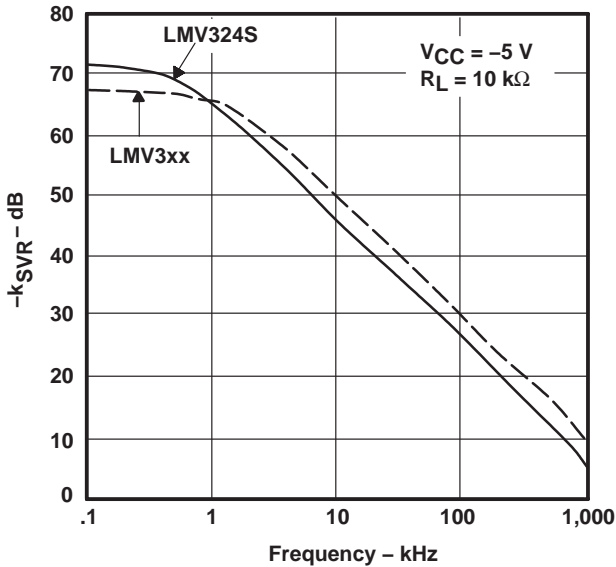

Figure 19

**+k_{SVR}
vs
FREQUENCY**

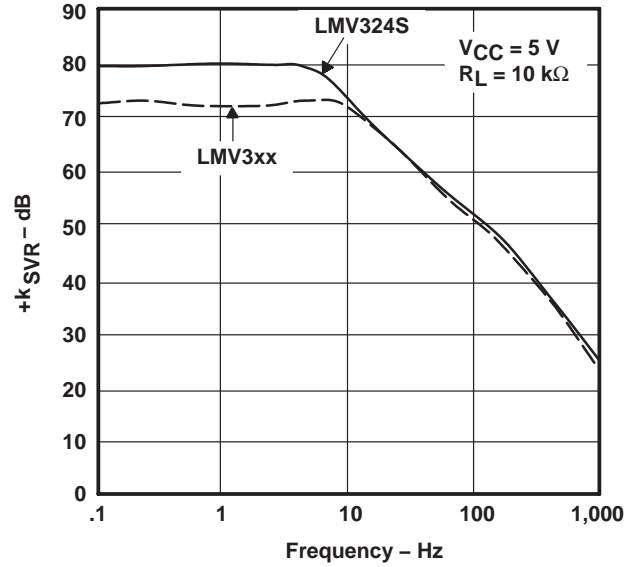

Figure 20



LMV321 SINGLE, LMV358 DUAL, LMV324 QUAD, LMV324S QUAD WITH SHUTDOWN LOW-VOLTAGE RAIL-TO-RAIL OUTPUT OPERATIONAL AMPLIFIERS

SLOS263Q – AUGUST 1999 – REVISED OCTOBER 2004

TYPICAL CHARACTERISTICS

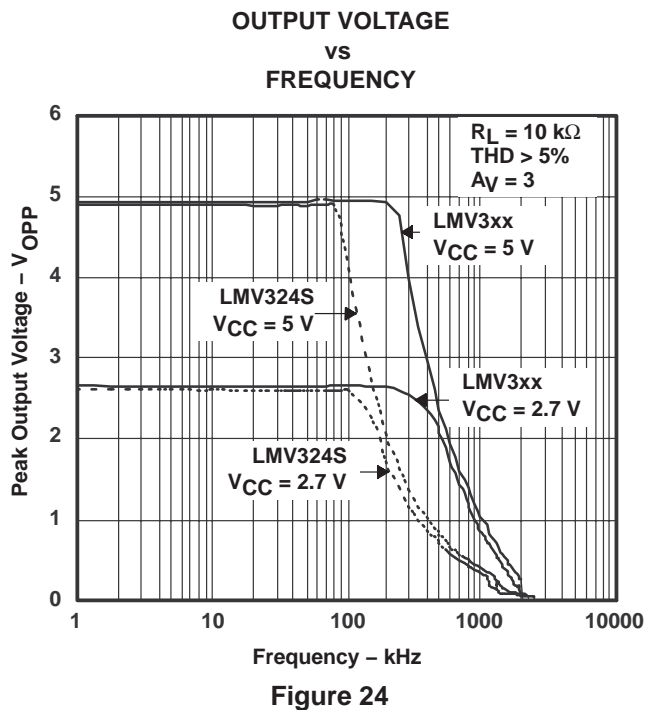
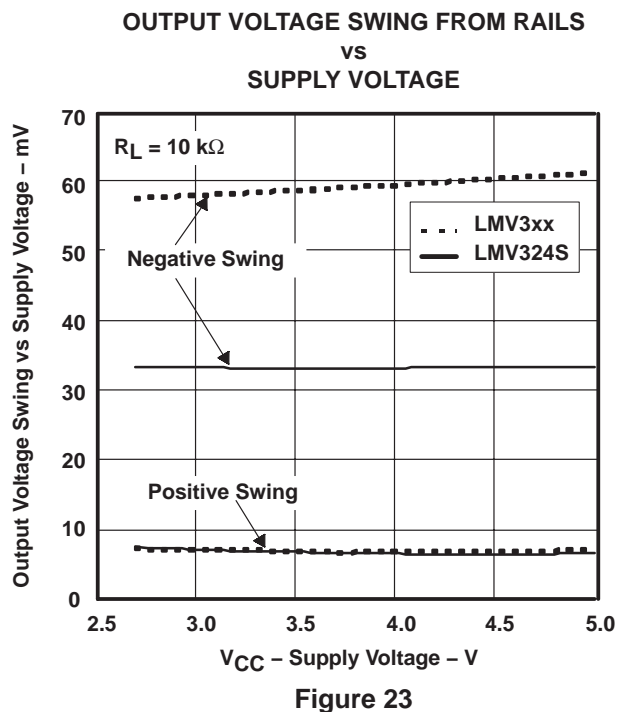
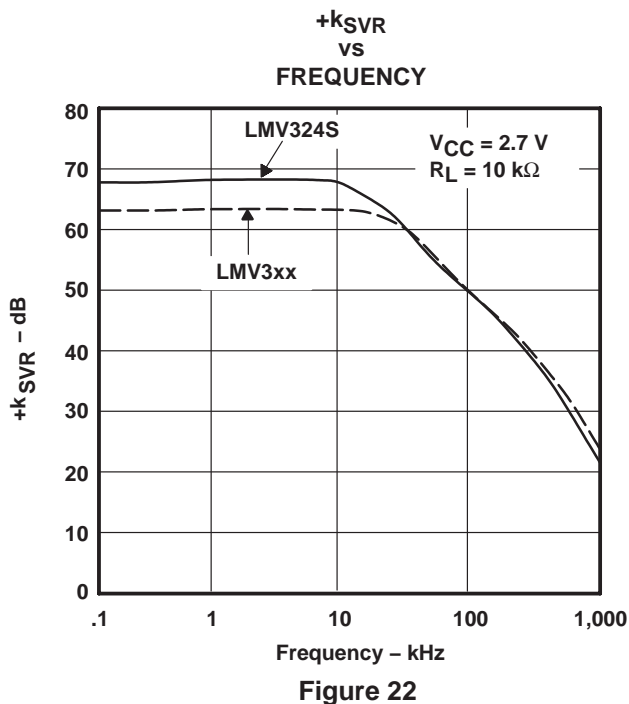
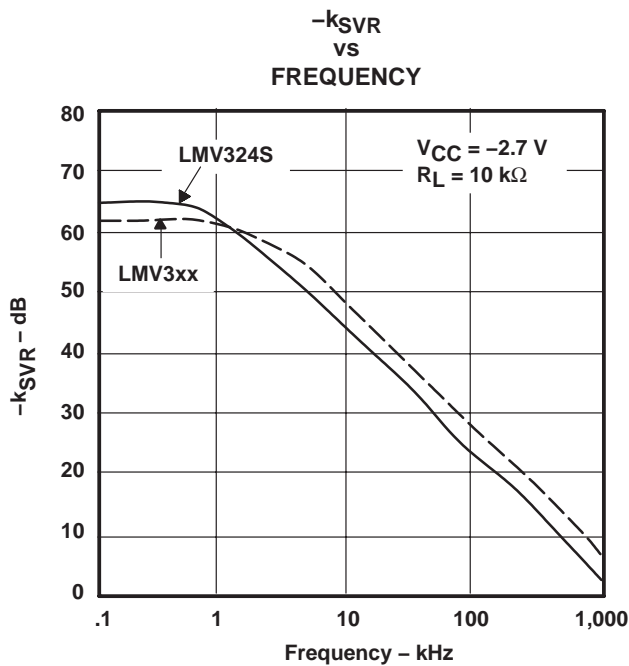

LMV321 SINGLE, LMV358 DUAL, LMV324 QUAD, LMV324S QUAD WITH SHUTDOWN LOW-VOLTAGE RAIL-TO-RAIL OUTPUT OPERATIONAL AMPLIFIERS

SLOS263Q – AUGUST 1999 – REVISED OCTOBER 2004

TYPICAL CHARACTERISTICS

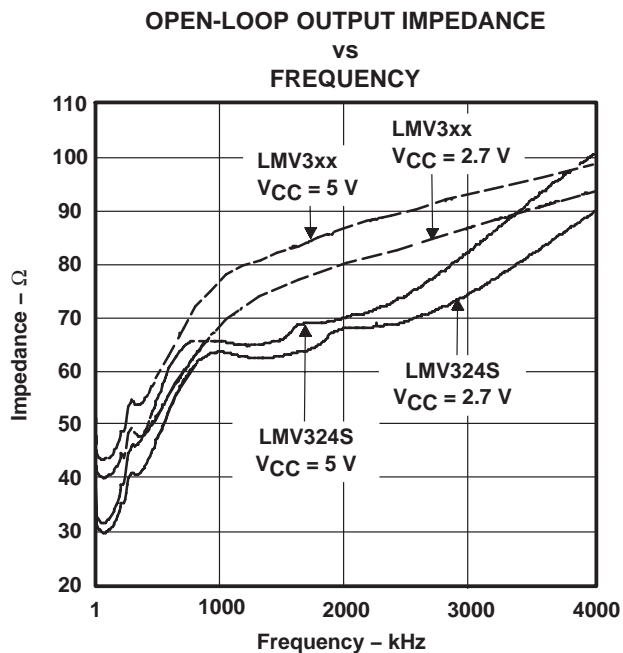

Figure 25

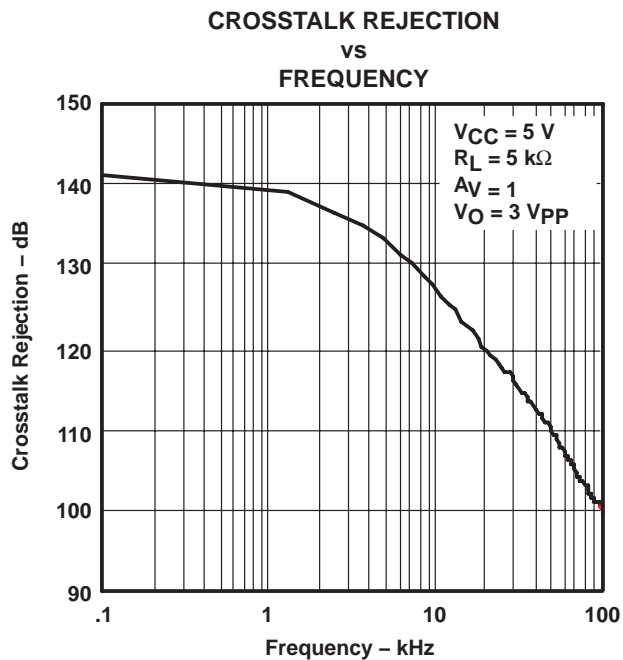

Figure 26

LMV321 SINGLE, LMV358 DUAL, LMV324 QUAD, LMV324S QUAD WITH SHUTDOWN LOW-VOLTAGE RAIL-TO-RAIL OUTPUT OPERATIONAL AMPLIFIERS

SLOS263Q – AUGUST 1999 – REVISED OCTOBER 2004

TYPICAL CHARACTERISTICS

NONINVERTING LARGE-SIGNAL PULSE RESPONSE

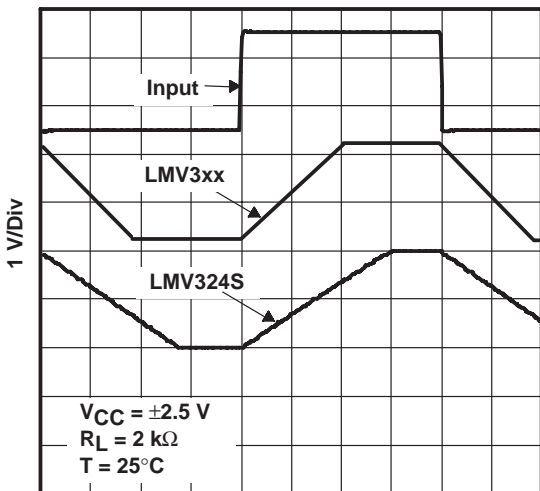

Figure 27

NONINVERTING LARGE-SIGNAL PULSE RESPONSE

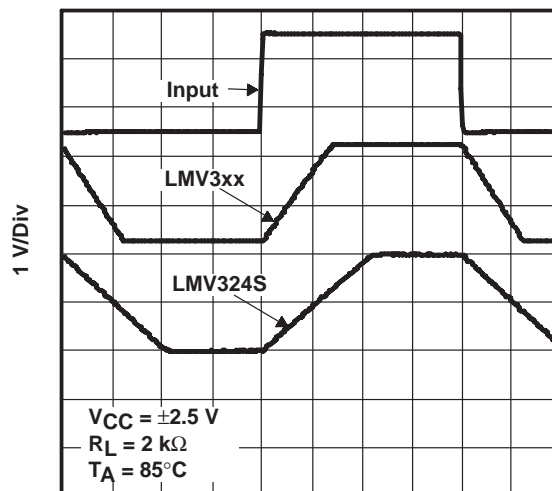

Figure 28

NONINVERTING LARGE-SIGNAL PULSE RESPONSE

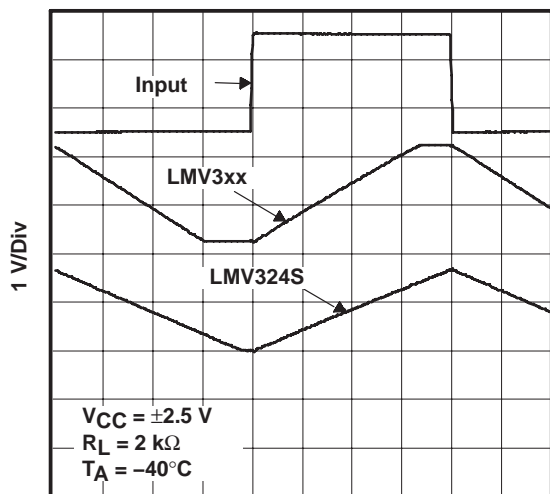

Figure 29

LMV321 SINGLE, LMV358 DUAL, LMV324 QUAD, LMV324S QUAD WITH SHUTDOWN LOW-VOLTAGE RAIL-TO-RAIL OUTPUT OPERATIONAL AMPLIFIERS

SLOS263Q – AUGUST 1999 – REVISED OCTOBER 2004

TYPICAL CHARACTERISTICS

NONINVERTING SMALL-SIGNAL PULSE RESPONSE

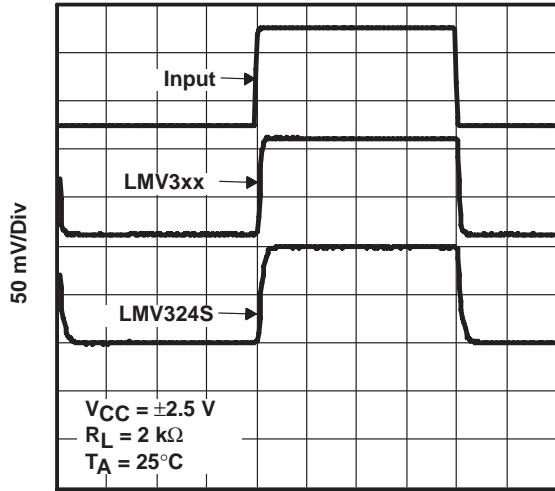

1 $\mu\text{s}/\text{Div}$
Figure 30

NONINVERTING SMALL-SIGNAL PULSE RESPONSE

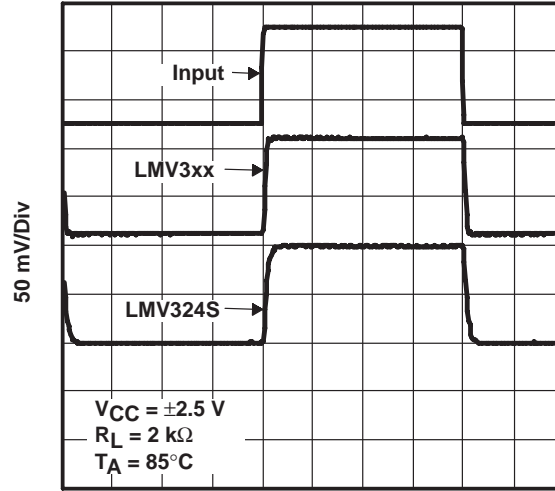

1 $\mu\text{s}/\text{Div}$
Figure 31

NONINVERTING SMALL-SIGNAL PULSE RESPONSE

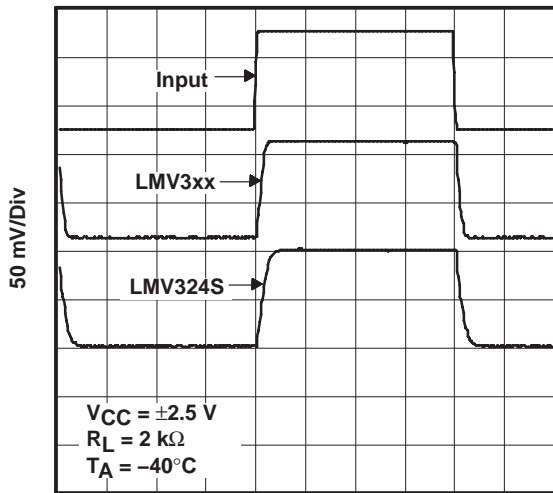

1 $\mu\text{s}/\text{Div}$
Figure 32

LMV321 SINGLE, LMV358 DUAL, LMV324 QUAD, LMV324S QUAD WITH SHUTDOWN LOW-VOLTAGE RAIL-TO-RAIL OUTPUT OPERATIONAL AMPLIFIERS

SLOS263Q – AUGUST 1999 – REVISED OCTOBER 2004

TYPICAL CHARACTERISTICS

INVERTING LARGE-SIGNAL PULSE RESPONSE

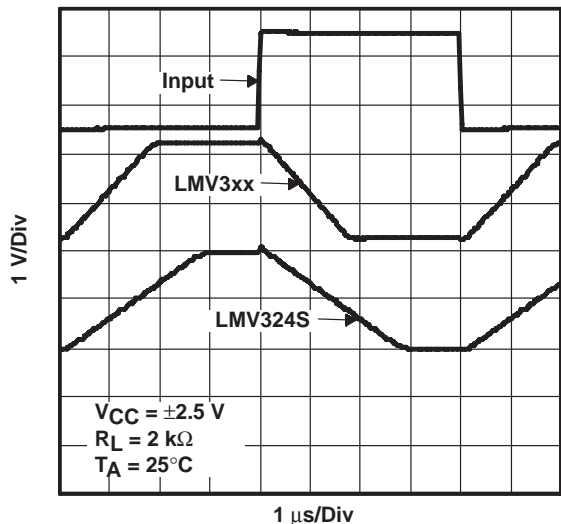

Figure 33

INVERTING LARGE-SIGNAL PULSE RESPONSE

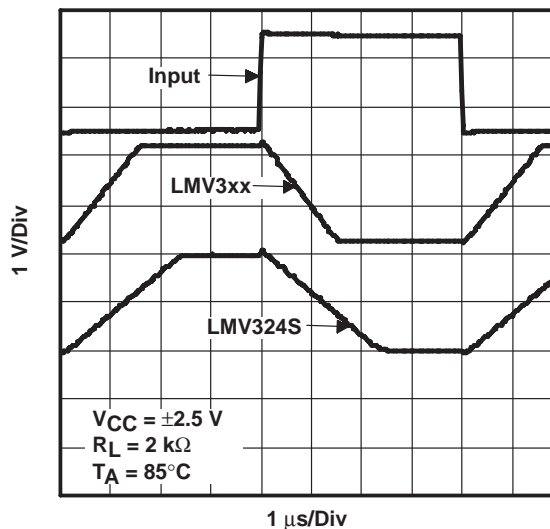

Figure 34

INVERTING LARGE-SIGNAL PULSE RESPONSE

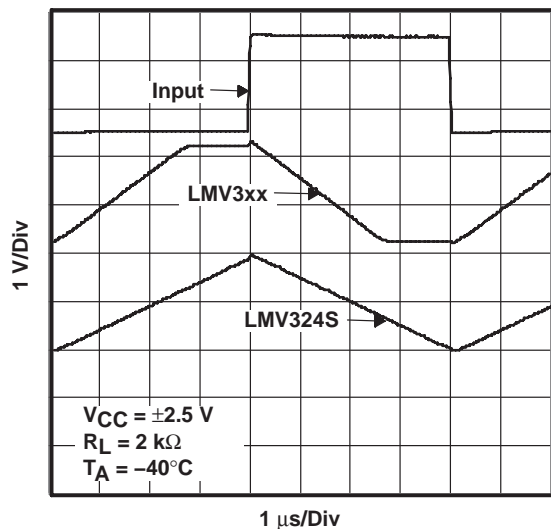

Figure 35

LMV321 SINGLE, LMV358 DUAL, LMV324 QUAD, LMV324S QUAD WITH SHUTDOWN LOW-VOLTAGE RAIL-TO-RAIL OUTPUT OPERATIONAL AMPLIFIERS

SLOS263Q – AUGUST 1999 – REVISED OCTOBER 2004

TYPICAL CHARACTERISTICS

INVERTING SMALL-SIGNAL PULSE RESPONSE

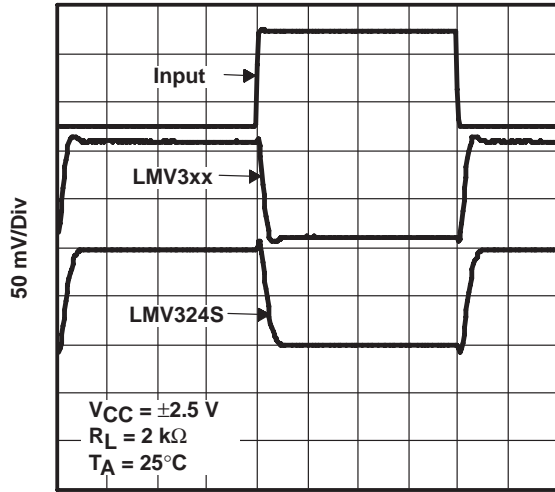

Figure 36

INVERTING SMALL-SIGNAL PULSE RESPONSE

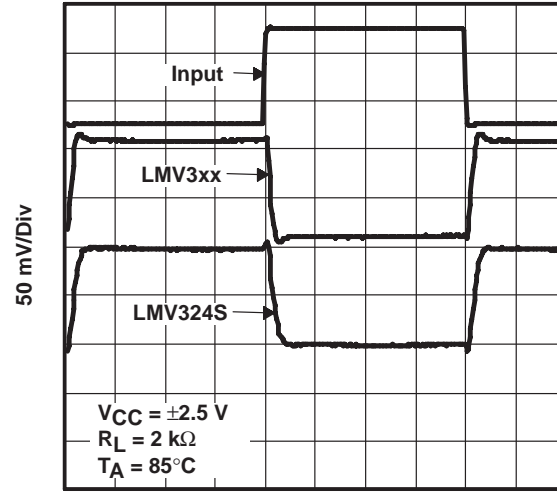

Figure 37

INVERTING SMALL-SIGNAL PULSE RESPONSE

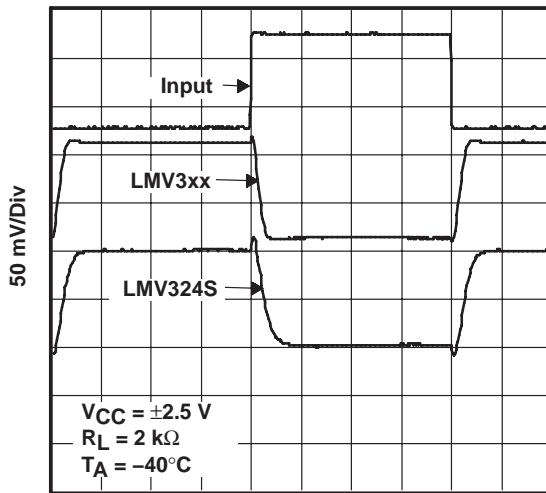

Figure 38

TYPICAL CHARACTERISTICS

INPUT CURRENT NOISE
 vs
 FREQUENCY

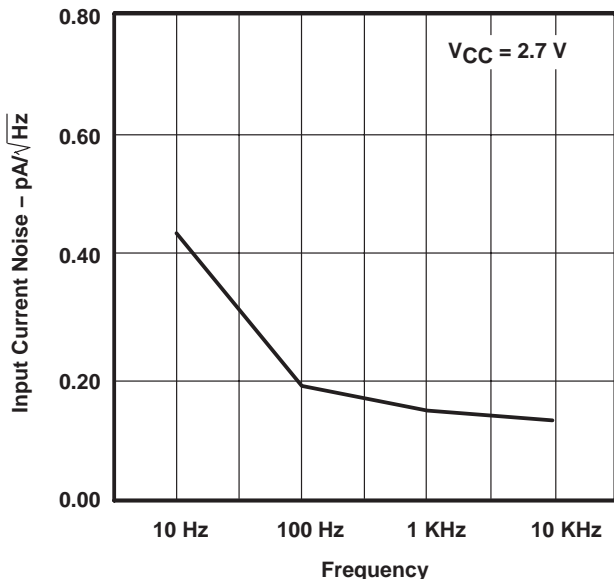

Figure 39

INPUT CURRENT NOISE
 vs
 FREQUENCY

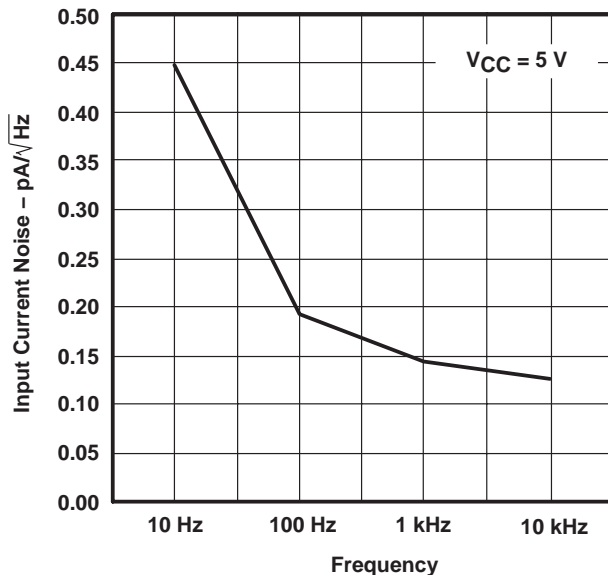

Figure 40

INPUT VOLTAGE NOISE
 vs
 FREQUENCY

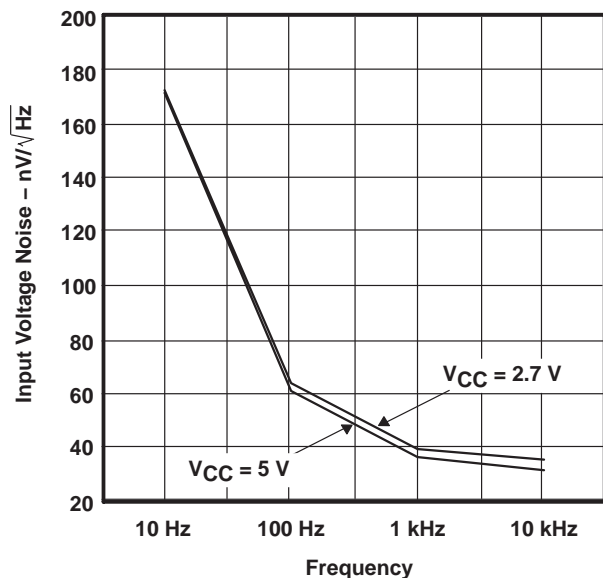
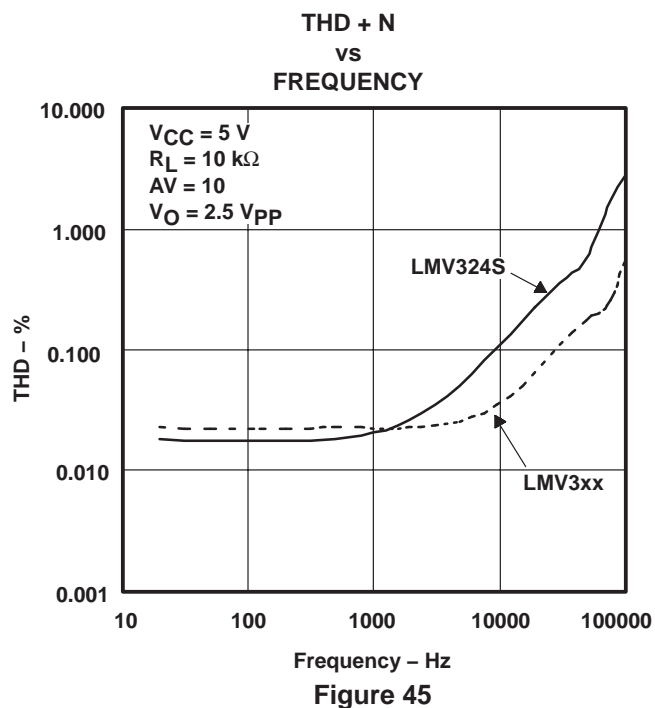
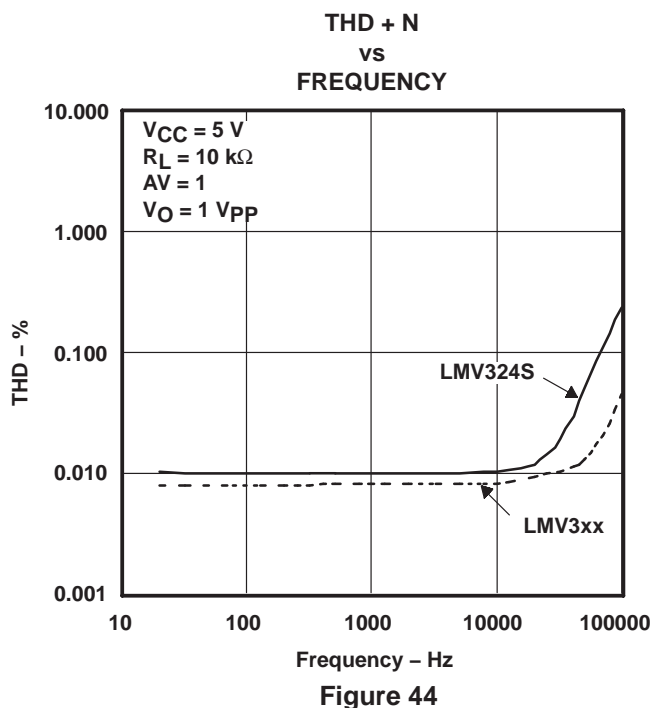
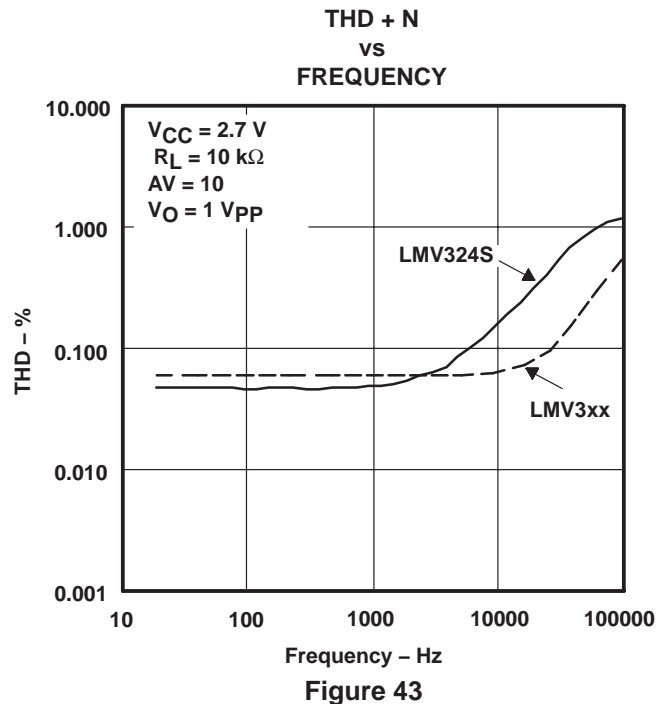
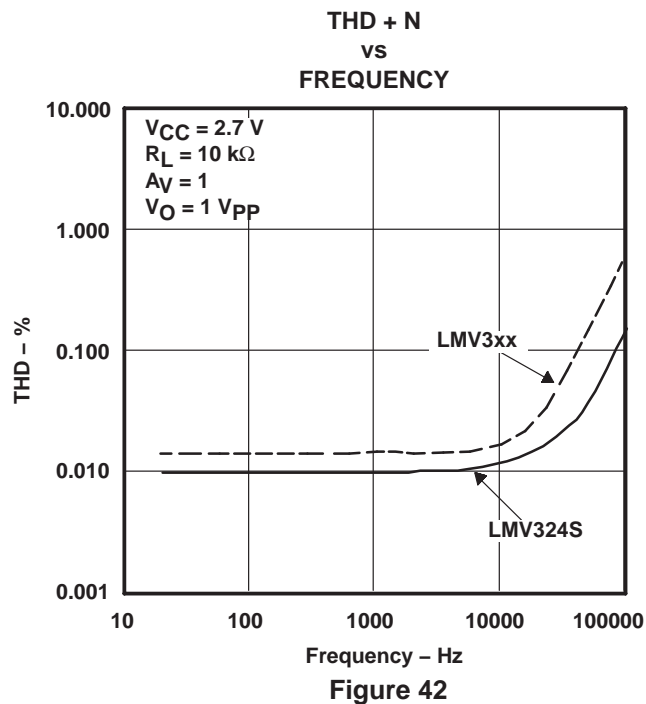

Figure 41

LMV321 SINGLE, LMV358 DUAL, LMV324 QUAD, LMV324S QUAD WITH SHUTDOWN LOW-VOLTAGE RAIL-TO-RAIL OUTPUT OPERATIONAL AMPLIFIERS

SLOS263Q – AUGUST 1999 – REVISED OCTOBER 2004

TYPICAL CHARACTERISTICS



PACKAGING INFORMATION

Orderable Device	Status ⁽¹⁾	Package Type	Package Drawing	Pins	Package Qty	Eco Plan ⁽²⁾	Lead/Ball Finish	MSL Peak Temp ⁽³⁾
LMV321IDBVR	ACTIVE	SOT-23	DBV	5	3000	Green (RoHS & no Sb/Br)	CU NIPDAU	Level-1-260C-UNLIM
LMV321IDBVT	ACTIVE	SOT-23	DBV	5	250	Green (RoHS & no Sb/Br)	CU NIPDAU	Level-1-260C-UNLIM
LMV321IDCKR	ACTIVE	SC70	DCK	5	3000	Green (RoHS & no Sb/Br)	CU NIPDAU	Level-1-260C-UNLIM
LMV321IDCKT	ACTIVE	SC70	DCK	5	250	Pb-Free (RoHS)	CU NIPDAU	Level-1-260C-UNLIM
LMV324ID	ACTIVE	SOIC	D	14	50	Pb-Free (RoHS)	CU NIPDAU	Level-2-260C-1 YEAR/ Level-1-235C-UNLIM
LMV324IDR	ACTIVE	SOIC	D	14	2500	Pb-Free (RoHS)	CU NIPDAU	Level-2-260C-1 YEAR/ Level-1-235C-UNLIM
LMV324IPWR	ACTIVE	TSSOP	PW	14	2000	Pb-Free (RoHS)	CU NIPDAU	Level-1-250C-UNLIM
LMV324QD	ACTIVE	SOIC	D	14	50	Pb-Free (RoHS)	CU NIPDAU	Level-2-260C-1 YEAR/ Level-1-235C-UNLIM
LMV324QDR	ACTIVE	SOIC	D	14	2500	Pb-Free (RoHS)	CU NIPDAU	Level-2-260C-1 YEAR/ Level-1-235C-UNLIM
LMV324QPW	ACTIVE	TSSOP	PW	14	90	Pb-Free (RoHS)	CU NIPDAU	Level-1-250C-UNLIM
LMV324QPWR	ACTIVE	TSSOP	PW	14	2000	Pb-Free (RoHS)	CU NIPDAU	Level-1-250C-UNLIM
LMV324SID	ACTIVE	SOIC	D	16	40	Pb-Free (RoHS)	CU NIPDAU	Level-2-260C-1 YEAR/ Level-1-235C-UNLIM
LMV324SIDR	ACTIVE	SOIC	D	16	2500	Pb-Free (RoHS)	CU NIPDAU	Level-2-260C-1 YEAR/ Level-1-235C-UNLIM
LMV324SIPWR	ACTIVE	TSSOP	PW	16	2000	Pb-Free (RoHS)	CU NIPDAU	Level-1-250C-UNLIM
LMV358ID	ACTIVE	SOIC	D	8	75	Pb-Free (RoHS)	CU NIPDAU	Level-2-260C-1 YEAR/ Level-1-235C-UNLIM
LMV358IDDUR	ACTIVE	VSSOP	DDU	8	3000	Pb-Free (RoHS)	CU NIPDAU	Level-1-260C-UNLIM
LMV358IDGKR	ACTIVE	MSOP	DGK	8	2500	Green (RoHS & no Sb/Br)	CU NIPDAU	Level-2-260C-1YEAR
LMV358IDR	ACTIVE	SOIC	D	8	2500	Green (RoHS & no Sb/Br)	CU NIPDAU	Level-1-260C-UNLIM
LMV358IPW	ACTIVE	TSSOP	PW	8	150	Pb-Free (RoHS)	CU NIPDAU	Level-1-250C-UNLIM
LMV358IPWR	ACTIVE	TSSOP	PW	8	2000	Pb-Free (RoHS)	CU NIPDAU	Level-1-250C-UNLIM
LMV358QD	ACTIVE	SOIC	D	8	75	Pb-Free (RoHS)	CU NIPDAU	Level-2-260C-1 YEAR/ Level-1-235C-UNLIM
LMV358QDDUR	ACTIVE	VSSOP	DDU	8	3000	Pb-Free (RoHS)	CU NIPDAU	Level-1-260C-UNLIM
LMV358QDGKR	ACTIVE	MSOP	DGK	8	2500	Green (RoHS & no Sb/Br)	CU NIPDAU	Level-2-260C-1YEAR
LMV358QDR	ACTIVE	SOIC	D	8	2500	Pb-Free (RoHS)	CU NIPDAU	Level-2-260C-1 YEAR/ Level-1-235C-UNLIM
LMV358QPW	ACTIVE	TSSOP	PW	8	150	Pb-Free (RoHS)	CU NIPDAU	Level-1-250C-UNLIM

Orderable Device	Status ⁽¹⁾	Package Type	Package Drawing	Pins	Package Qty	Eco Plan ⁽²⁾	Lead/Ball Finish	MSL Peak Temp ⁽³⁾
LMV358QPWR	ACTIVE	TSSOP	PW	8	2000	Pb-Free (RoHS)	CU NIPDAU	Level-1-250C-UNLIM

⁽¹⁾ The marketing status values are defined as follows:

ACTIVE: Product device recommended for new designs.

LIFEBUY: TI has announced that the device will be discontinued, and a lifetime-buy period is in effect.

NRND: Not recommended for new designs. Device is in production to support existing customers, but TI does not recommend using this part in a new design.

PREVIEW: Device has been announced but is not in production. Samples may or may not be available.

OBSOLETE: TI has discontinued the production of the device.

⁽²⁾ Eco Plan - May not be currently available - please check <http://www.ti.com/productcontent> for the latest availability information and additional product content details.

None: Not yet available Lead (Pb-Free).

Pb-Free (RoHS): TI's terms "Lead-Free" or "Pb-Free" mean semiconductor products that are compatible with the current RoHS requirements for all 6 substances, including the requirement that lead not exceed 0.1% by weight in homogeneous materials. Where designed to be soldered at high temperatures, TI Pb-Free products are suitable for use in specified lead-free processes.

Green (RoHS & no Sb/Br): TI defines "Green" to mean "Pb-Free" and in addition, uses package materials that do not contain halogens, including bromine (Br) or antimony (Sb) above 0.1% of total product weight.

⁽³⁾ MSL, Peak Temp. -- The Moisture Sensitivity Level rating according to the JEDEC industry standard classifications, and peak solder temperature.

Important Information and Disclaimer: The information provided on this page represents TI's knowledge and belief as of the date that it is provided. TI bases its knowledge and belief on information provided by third parties, and makes no representation or warranty as to the accuracy of such information. Efforts are underway to better integrate information from third parties. TI has taken and continues to take reasonable steps to provide representative and accurate information but may not have conducted destructive testing or chemical analysis on incoming materials and chemicals. TI and TI suppliers consider certain information to be proprietary, and thus CAS numbers and other limited information may not be available for release.

In no event shall TI's liability arising out of such information exceed the total purchase price of the TI part(s) at issue in this document sold by TI to Customer on an annual basis.

DBV (R-PDSO-G5)

PLASTIC SMALL-OUTLINE PACKAGE

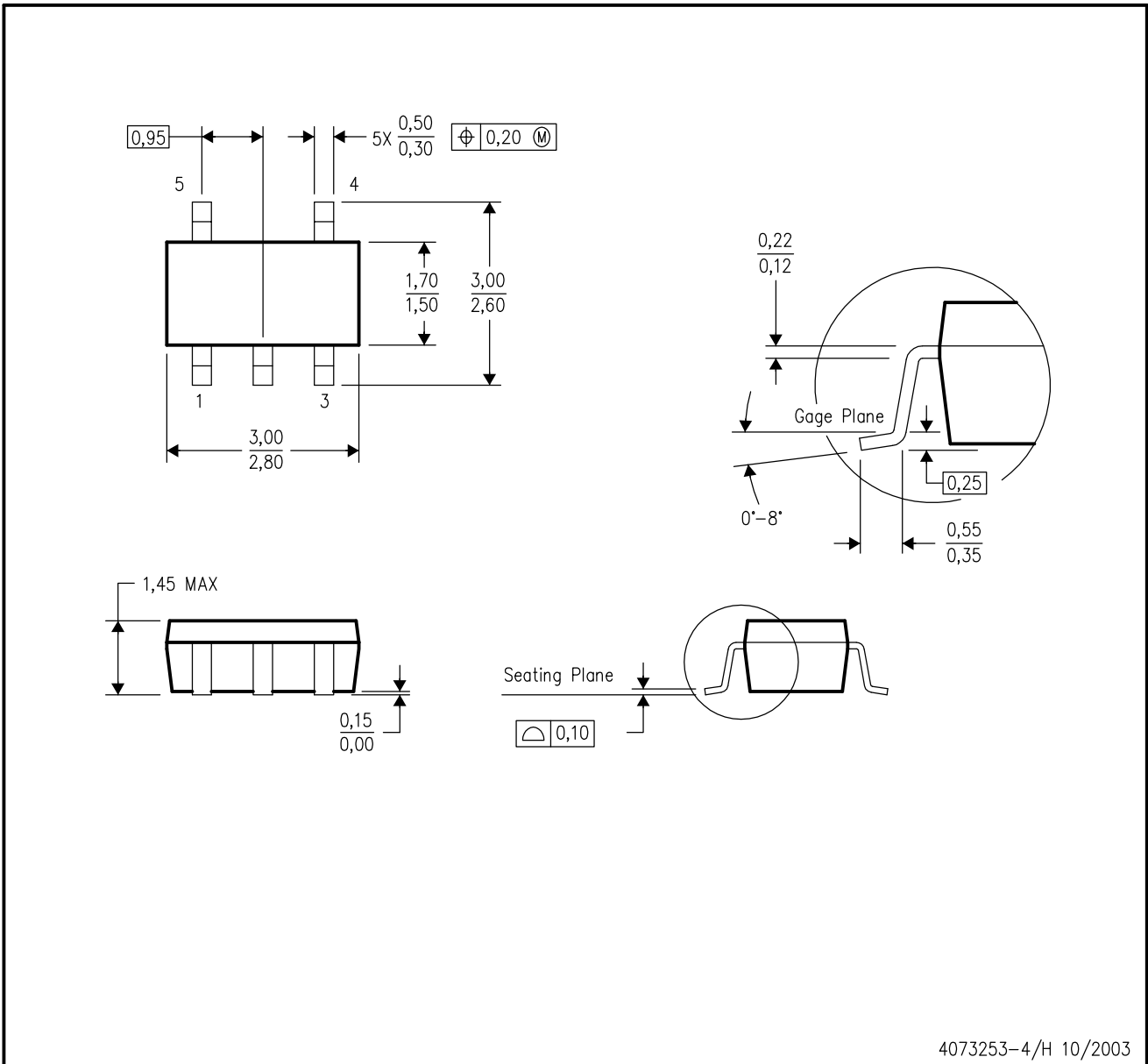

4073253-4/H 10/2003

- NOTES:
- A. All linear dimensions are in millimeters.
 - B. This drawing is subject to change without notice.
 - C. Body dimensions do not include mold flash or protrusion.
 - D. Falls within JEDEC MO-178 Variation AA.

DCK (R-PDSO-G5)

PLASTIC SMALL-OUTLINE PACKAGE



- NOTES: A. All linear dimensions are in millimeters.
 B. This drawing is subject to change without notice.
 C. Body dimensions do not include mold flash or protrusion.
 D. Falls within JEDEC MO-203

DGK (S-PDSO-G8)

PLASTIC SMALL-OUTLINE PACKAGE

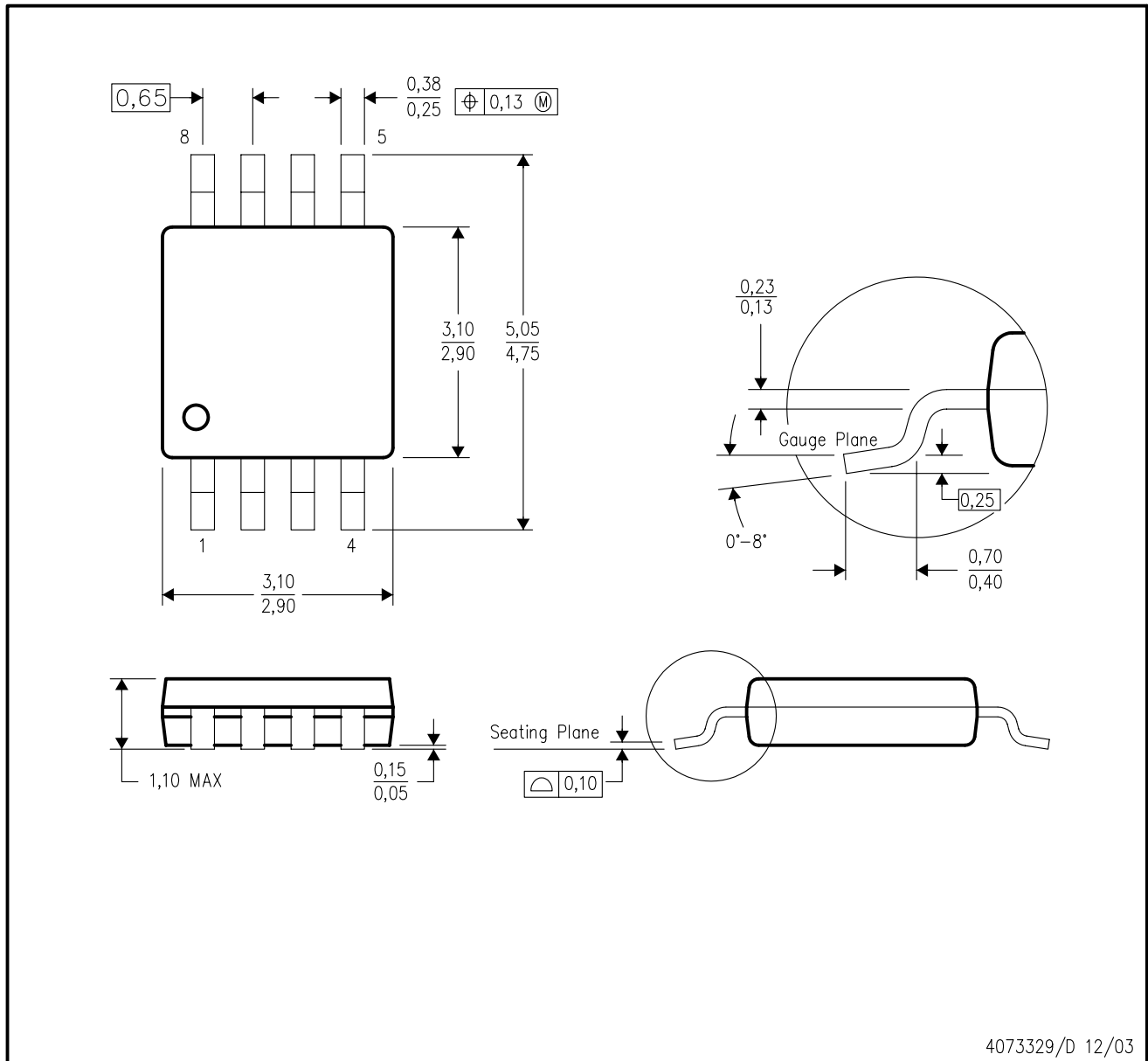

- NOTES:
- A. All linear dimensions are in millimeters.
 - B. This drawing is subject to change without notice.
 - C. Body dimensions do not include mold flash or protrusion.
 - D. Falls within JEDEC MO-187 variation AA.

DDU (R-PDSO-G8)

PLASTIC SMALL-OUTLINE PACKAGE

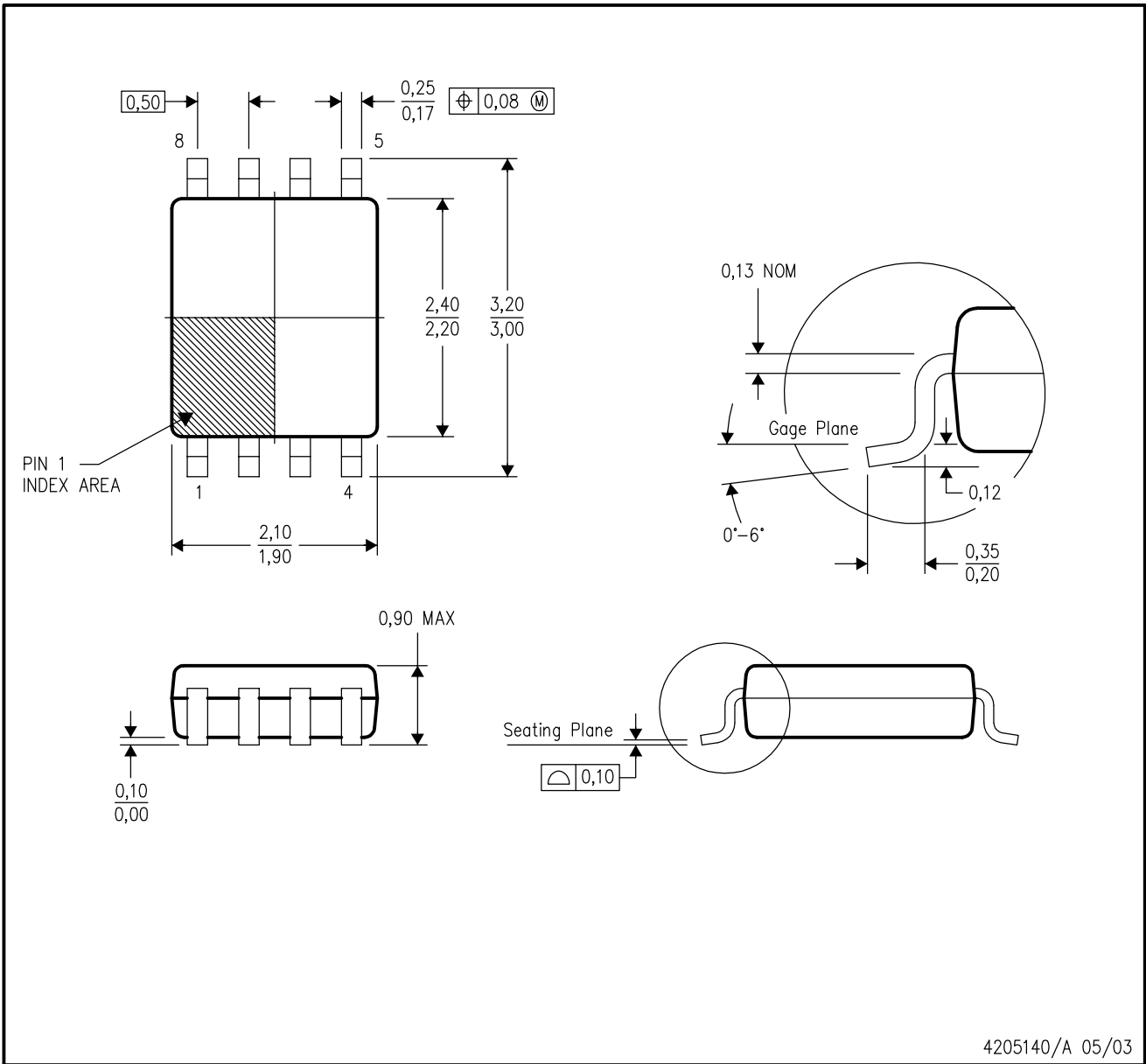

- NOTES:
- A. All linear dimensions are in millimeters.
 - B. This drawing is subject to change without notice.
 - C. Body dimensions do not include mold flash or protrusion.
 - D. Falls within JEDEC MO-187 variation CA.

D (R-PDSO-G14)

PLASTIC SMALL-OUTLINE PACKAGE



- NOTES:
- A. All linear dimensions are in inches (millimeters).
 - B. This drawing is subject to change without notice.
 - C. Body dimensions do not include mold flash or protrusion not to exceed 0.006 (0,15).
 - D. Falls within JEDEC MS-012 variation AB.

D (R-PDSO-G16)

PLASTIC SMALL-OUTLINE PACKAGE



- NOTES:
- All linear dimensions are in inches (millimeters).
 - This drawing is subject to change without notice.
 - Body dimensions do not include mold flash or protrusion not to exceed 0.006 (0,15).
 - Falls within JEDEC MS-012 variation AC.

D (R-PDSO-G8)

PLASTIC SMALL-OUTLINE PACKAGE

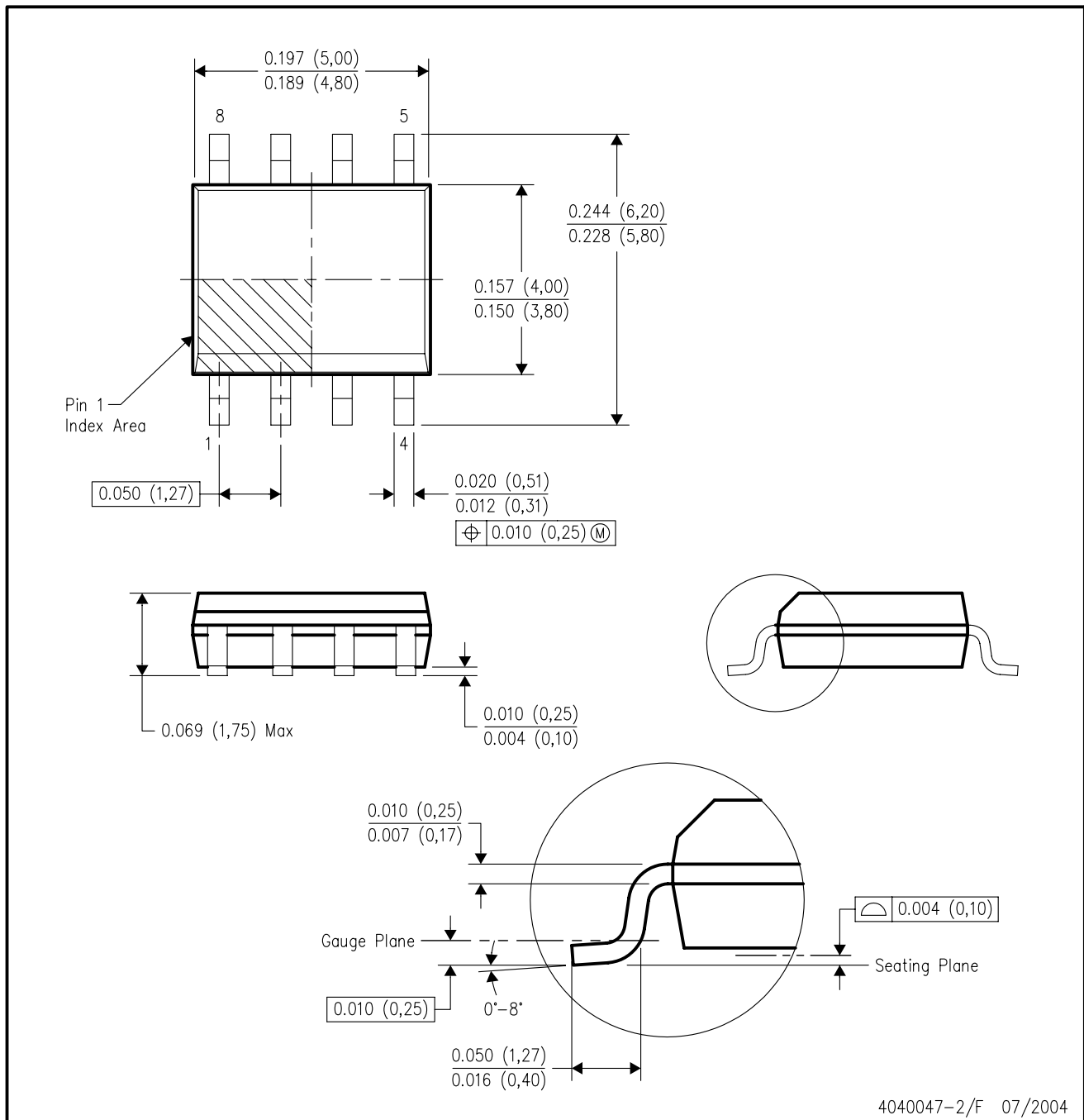

- NOTES:
- A. All linear dimensions are in inches (millimeters).
 - B. This drawing is subject to change without notice.
 - C. Body dimensions do not include mold flash or protrusion not to exceed 0.006 (0,15).
 - D. Falls within JEDEC MS-012 variation AA.

PW (R-PDSO-G**)

PLASTIC SMALL-OUTLINE PACKAGE

14 PINS SHOWN



4040064/F 01/97

- NOTES: A. All linear dimensions are in millimeters.
 B. This drawing is subject to change without notice.
 C. Body dimensions do not include mold flash or protrusion not to exceed 0,15.
 D. Falls within JEDEC MO-153

IMPORTANT NOTICE

Texas Instruments Incorporated and its subsidiaries (TI) reserve the right to make corrections, modifications, enhancements, improvements, and other changes to its products and services at any time and to discontinue any product or service without notice. Customers should obtain the latest relevant information before placing orders and should verify that such information is current and complete. All products are sold subject to TI's terms and conditions of sale supplied at the time of order acknowledgment.

TI warrants performance of its hardware products to the specifications applicable at the time of sale in accordance with TI's standard warranty. Testing and other quality control techniques are used to the extent TI deems necessary to support this warranty. Except where mandated by government requirements, testing of all parameters of each product is not necessarily performed.

TI assumes no liability for applications assistance or customer product design. Customers are responsible for their products and applications using TI components. To minimize the risks associated with customer products and applications, customers should provide adequate design and operating safeguards.

TI does not warrant or represent that any license, either express or implied, is granted under any TI patent right, copyright, mask work right, or other TI intellectual property right relating to any combination, machine, or process in which TI products or services are used. Information published by TI regarding third-party products or services does not constitute a license from TI to use such products or services or a warranty or endorsement thereof. Use of such information may require a license from a third party under the patents or other intellectual property of the third party, or a license from TI under the patents or other intellectual property of TI.

Reproduction of information in TI data books or data sheets is permissible only if reproduction is without alteration and is accompanied by all associated warranties, conditions, limitations, and notices. Reproduction of this information with alteration is an unfair and deceptive business practice. TI is not responsible or liable for such altered documentation.

Resale of TI products or services with statements different from or beyond the parameters stated by TI for that product or service voids all express and any implied warranties for the associated TI product or service and is an unfair and deceptive business practice. TI is not responsible or liable for any such statements.

Following are URLs where you can obtain information on other Texas Instruments products and application solutions:

Products		Applications	
Amplifiers	amplifier.ti.com	Audio	www.ti.com/audio
Data Converters	dataconverter.ti.com	Automotive	www.ti.com/automotive
DSP	dsp.ti.com	Broadband	www.ti.com/broadband
Interface	interface.ti.com	Digital Control	www.ti.com/digitalcontrol
Logic	logic.ti.com	Military	www.ti.com/military
Power Mgmt	power.ti.com	Optical Networking	www.ti.com/opticalnetwork
Microcontrollers	microcontroller.ti.com	Security	www.ti.com/security
		Telephony	www.ti.com/telephony
		Video & Imaging	www.ti.com/video
		Wireless	www.ti.com/wireless

Mailing Address: Texas Instruments
Post Office Box 655303 Dallas, Texas 75265