

LMV321-Q1 SINGLE, LMV358-Q1 DUAL, LMV324-Q1 QUAD LOW-VOLTAGE RAIL-TO-RAIL OUTPUT OPERATIONAL AMPLIFIERS

SLOS415D – JUNE 2003 – REVISED OCTOBER 2004

- **Qualification in Accordance With AEC-Q100†**
- **Qualified for Automotive Applications**
- **Customer-Specific Configuration Control Can Be Supported Along With Major-Change Approval**
- **2.7-V and 5-V Performance**
- **No Crossover Distortion**
- **Low Supply Current:**
 LMV321 . . . 130 μ A Typ
 LMV358 . . . 210 μ A Typ
 LMV324 . . . 410 μ A Typ
- **Rail-to-Rail Output Swing**

†Contact factory for details. Q100 qualification data available on request.

description/ordering information

The LMV321, LMV358, and LMV324 are single, dual, and quad low-voltage (2.7 V to 5.5 V) operational amplifiers with rail-to-rail output swing.

The LMV321, LMV358, and LMV324 are the most cost-effective solution for applications where low-voltage operation, space saving, and low price are required. These amplifiers were designed specifically for low-voltage (2.7 V to 5 V) operation, with performance specifications meeting or exceeding the LM358 and LM324 devices that operate from 5 V to 30 V. Additional features of the LMV3xx devices are a common-mode input voltage range that includes ground, 1-MHz unity-gain bandwidth, and 1-V/ μ s slew rate.

LMV324 . . . D OR PW PACKAGE
(TOP VIEW)

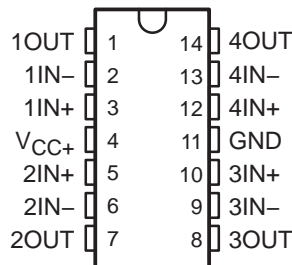

LMV358 . . . D OR PW PACKAGE
(TOP VIEW)

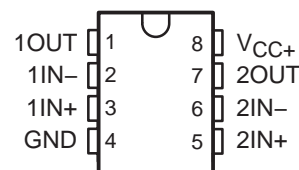

LMV321 . . . DBV PACKAGE
(TOP VIEW)

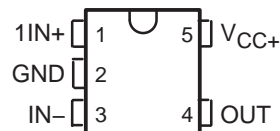

Please be aware that an important notice concerning availability, standard warranty, and use in critical applications of Texas Instruments semiconductor products and disclaimers thereto appears at the end of this data sheet.

PRODUCTION DATA information is current as of publication date. Products conform to specifications per the terms of Texas Instruments standard warranty. Production processing does not necessarily include testing of all parameters.

 **TEXAS
INSTRUMENTS**

POST OFFICE BOX 655303 • DALLAS, TEXAS 75265

Copyright © 2004, Texas Instruments Incorporated

LMV321-Q1 SINGLE, LMV358-Q1 DUAL, LMV324-Q1 QUAD LOW-VOLTAGE RAIL-TO-RAIL OUTPUT OPERATIONAL AMPLIFIERS

SLOS415D – JUNE 2003 – REVISED OCTOBER 2004

ORDERING INFORMATION

T _A		PACKAGE†		ORDERABLE PART NUMBER	TOP-SIDE MARKING
-40°C to 85°C	Single	SOT23-5 (DBV)	Reel of 3000	LMV321IDBVRQ1	RC1B
-40°C to 85°C	Dual	SOIC (D)	Tube of 75	LMV358IDQ1	358IQ1
			Reel of 2500	LMV358IDRQ1	
		TSSOP (PW)	Reel of 2000	LMV358IPWRQ1	358IQ1
-40°C to 85°C	Quad	SOIC (D)	Tube of 50	LMV324IDQ1	LMV324IQ1
			Reel of 2500	LMV324IDRQ1	
		TSSOP (PW)	Reel of 2000	LMV324IPWRQ1	V324IQ1
-40°C to 125°C	Single	SOT23-5 (DBV)	Reel of 3000	LMV321QDBVRQ1	RCCB
-40°C to 125°C	Dual	SOIC (D)	Tube of 75	LMV358QDQ1	V358Q1
			Reel of 2500	LMV358QDRQ1	
		TSSOP (PW)	Reel of 2000	LMV358QPWRQ1	V358Q1
-40°C to 125°C	Quad	SOIC (D)	Tube of 50	LMV324QDQ1	LMV324Q1
			Reel of 2500	LMV324QDRQ1	
		TSSOP (PW)	Reel of 2000	LMV324QPWRQ1	MV324Q1

† Package drawings, standard packing quantities, thermal data, symbolization, and PCB design guidelines are available at www.ti.com/sc/package.

symbol (each amplifier)

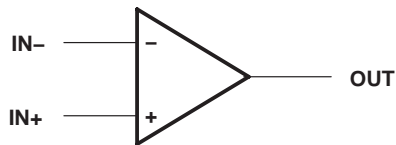

LMV321-Q1 SINGLE, LMV358-Q1 DUAL, LMV324-Q1 QUAD LOW-VOLTAGE RAIL-TO-RAIL OUTPUT OPERATIONAL AMPLIFIERS

SLOS415D – JUNE 2003 – REVISED OCTOBER 2004

LMV324 simplified schematic

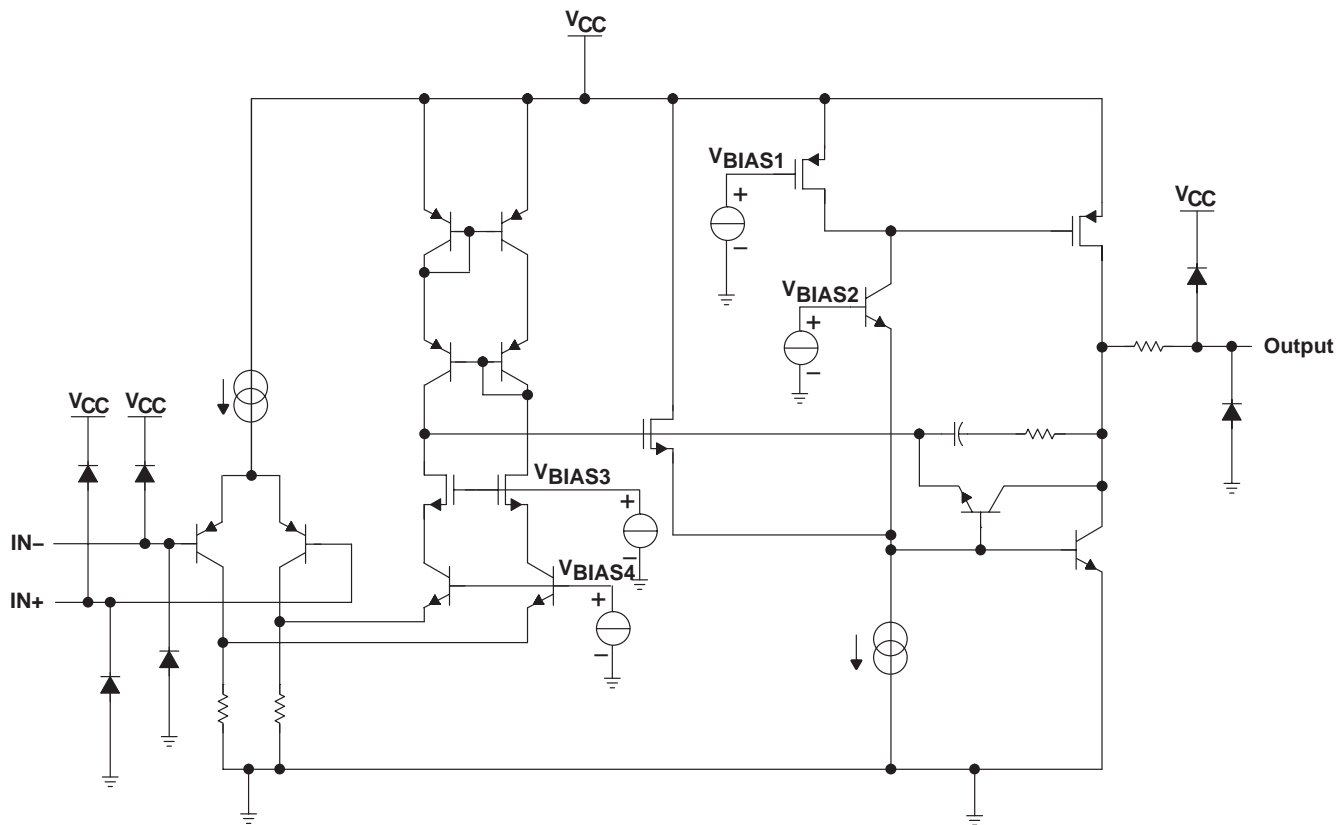

absolute maximum ratings over operating free-air temperature range (unless otherwise noted)†

Supply voltage, V_{CC} (see Note 1)	5.5 V
Differential input voltage, V_{ID} (see Note 2)	± 5.5 V
Input voltage, V_I (either input)	0 to 5.5 V
Duration of output short circuit (one amplifier) to ground at (or below) $T_A = 25^\circ\text{C}$, $V_{CC} \leq 5.5$ V (see Note 3)	Unlimited
Package thermal impedance, θ_{JA} (see Notes 4 and 5):	
D (8-pin) package	97°C/W
D (14-pin) package	86°C/W
DBV (5-pin) package	206°C/W
PW (8-pin) package	149°C/W
PW (14-pin) package	113°C/W
Operating virtual junction temperature, T_J	150°C
Storage temperature range, T_{stg}	-65 to 150°C

† Stresses beyond those listed under “absolute maximum ratings” may cause permanent damage to the device. These are stress ratings only, and functional operation of the device at these or any other conditions beyond those indicated under “recommended operating conditions” is not implied. Exposure to absolute-maximum-rated conditions for extended periods may affect device reliability.

- NOTES:
1. All voltage values (except differential voltages and V_{CC} specified for the measurement of I_{OS}) are with respect to the network GND.
 2. Differential voltages are at IN+ with respect to IN-.
 3. Short circuits from outputs to V_{CC} can cause excessive heating and eventual destruction.
 4. Maximum power dissipation is a function of $T_J(\text{max})$, θ_{JA} , and T_A . The maximum allowable power dissipation at any allowable ambient temperature is $P_D = (T_J(\text{max}) - T_A)/\theta_{JA}$. Selecting the maximum of 150°C can affect reliability.
 5. The package thermal impedance is calculated in accordance with JESD 51-7.

LMV321-Q1 SINGLE, LMV358-Q1 DUAL, LMV324-Q1 QUAD LOW-VOLTAGE RAIL-TO-RAIL OUTPUT OPERATIONAL AMPLIFIERS

SLOS415D – JUNE 2003 – REVISED OCTOBER 2004

recommended operating conditions (see Note 6)

		MIN	MAX	UNIT	
V _{CC}	Supply voltage (single-supply operation)	2.7	5.5	V	
V _{IH}	Amplifier turn-on voltage level	V _{CC} = 2.7 V	1.7	V	
		V _{CC} = 5 V	3.5		
V _{IL}	Amplifier turn-off voltage level	V _{CC} = 2.7 V	0.7	V	
		V _{CC} = 5 V	1.5		
T _A	Operating free-air temperature	I suffix	-40	85	°C
		Q suffix	-40	125	

NOTE 6: All unused control inputs of the device must be held at V_{CC} or GND to ensure proper device operation. Refer to the TI application report, *Implications of Slow or Floating CMOS Inputs*, literature number SCBA004.

electrical characteristics at T_A = 25°C, V_{CC+} = 2.7 V (unless otherwise noted)

PARAMETER	TEST CONDITIONS		MIN	TYP	MAX	UNIT
V _{IO}	Input offset voltage			1.7	7	mV
α _{V_{IO}}	Average temperature coefficient of input offset voltage			5		μV/°C
I _{IB}	Input bias current			11	250	nA
I _{IO}	Input offset current			5	50	nA
CMRR	Common-mode rejection ratio	V _{CM} = 0 to 1.7 V	50	63		dB
k _{SVR}	Supply-voltage rejection ratio	V _{CC} = 2.7 V to 5 V, V _O = 1 V	50	60		dB
V _{ICR}	Common-mode input voltage range	CMRR ≥ 50 dB	0 to 1.7	-0.2 to 1.9		V
Output swing	R _L = 10 kΩ to 1.35 V	High level	V _{CC} - 100	V _{CC} - 10		mV
		Low level		60	180	
I _{CC}	Supply current	LMV321		80	170	μA
		LMV358 (both amplifiers)		140	340	
		LMV324 (all four amplifiers)		260	680	
B ₁	Unity-gain bandwidth	C _L = 200 pF		1		MHz
φ _m	Phase margin			60		deg
G _m	Gain margin			10		dB
V _n	Equivalent input noise voltage	f = 1 kHz		46		nV/√Hz
I _n	Equivalent input noise current	f = 1 kHz		0.17		pA/√Hz



LMV321-Q1 SINGLE, LMV358-Q1 DUAL, LMV324-Q1 QUAD LOW-VOLTAGE RAIL-TO-RAIL OUTPUT OPERATIONAL AMPLIFIERS

SLOS415D – JUNE 2003 – REVISED OCTOBER 2004

electrical characteristics at specified free-air temperature range, $V_{CC+} = 5\text{ V}$ (unless otherwise noted)

PARAMETER		TEST CONDITIONS	T_A^\dagger	MIN	TYP	MAX	UNIT
V_{IO}	Input offset voltage		25°C		1.7	7	mV
			Full range			9	
$\alpha_{V_{IO}}$	Average temperature coefficient of input offset voltage		25°C		5		$\mu\text{V}/^\circ\text{C}$
I_{IB}	Input bias current		25°C		15	250	nA
			Full range			500	
I_{IO}	Input offset current		25°C		5	50	nA
			Full range			150	
CMRR	Common-mode rejection ratio	$V_{CM} = 0\text{ to }4\text{ V}$	25°C	50	65		dB
k_{SVR}	Supply-voltage rejection ratio	$V_{CC} = 2.7\text{ V to }5\text{ V}$, $V_O = 1\text{ V}$, $V_{CM} = 1\text{ V}$	25°C	50	60		dB
V_{ICR}	Common-mode input voltage range	$CMMR \geq 50\text{ dB}$	25°C	0 to 4	-0.2 to 4.2		V
Output swing	$R_L = 2\text{ k}\Omega\text{ to }2.5\text{ V}$	High level	25°C	$V_{CC} - 300$	$V_{CC} - 40$		mV
			Full range		$V_{CC} - 400$		
		Low level	25°C		120	300	
			Full range			400	
	$R_L = 10\text{ k}\Omega\text{ to }2.5\text{ V}$	High level	25°C	$V_{CC} - 100$	$V_{CC} - 10$		
			Full range		$V_{CC} - 200$		
		Low level	25°C		65	180	
			Full range			280	
A_{VD}	Large-signal differential voltage gain	$R_L = 2\text{ k}\Omega$	25°C	15	100		V/mV
			Full range		10		
I_{OS}	Output short-circuit current	Sourcing, $V_O = 0\text{ V}$	25°C	5	60		mA
		Sinking, $V_O = 5\text{ V}$		10	160		
I_{CC}	Supply current	LMV321	25°C		130	250	μA
			Full range			350	
		LMV358 (both amplifiers)	25°C		210	440	
			Full range			615	
		LMV324 (all four amplifiers)	25°C		410	830	
			Full range			1160	
B_1	Unity-gain bandwidth	$C_L = 200\text{ pF}$	25°C		1		MHz
ϕ_m	Phase margin		25°C		60		deg
G_m	Gain margin		25°C		10		dB
V_n	Equivalent input noise voltage	$f = 1\text{ kHz}$	25°C		39		$\text{nV}/\sqrt{\text{Hz}}$
I_n	Equivalent input noise current	$f = 1\text{ kHz}$	25°C		0.21		$\text{pA}/\sqrt{\text{Hz}}$
SR	Slew rate		25°C		1		$\text{V}/\mu\text{s}$

† Full range is -40°C to 85°C for I-level part, -40°C to 125°C for Q-level part.



**LMV321-Q1 SINGLE, LMV358-Q1 DUAL, LMV324-Q1 QUAD
LOW-VOLTAGE RAIL-TO-RAIL OUTPUT
OPERATIONAL AMPLIFIERS**

SLOS415D – JUNE 2003 – REVISED OCTOBER 2004

TYPICAL CHARACTERISTICS

**GAIN AND PHASE MARGIN
VS
FREQUENCY**

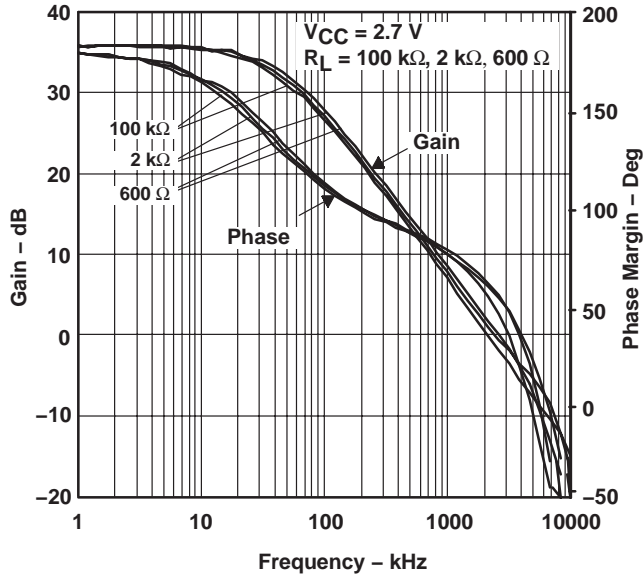

Figure 1

**GAIN AND PHASE MARGIN
VS
FREQUENCY**

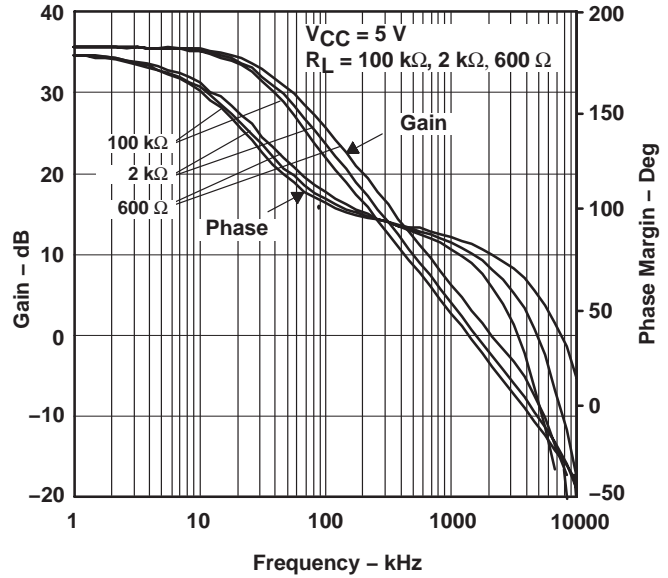

Figure 2

**GAIN AND PHASE MARGIN
VS
FREQUENCY**

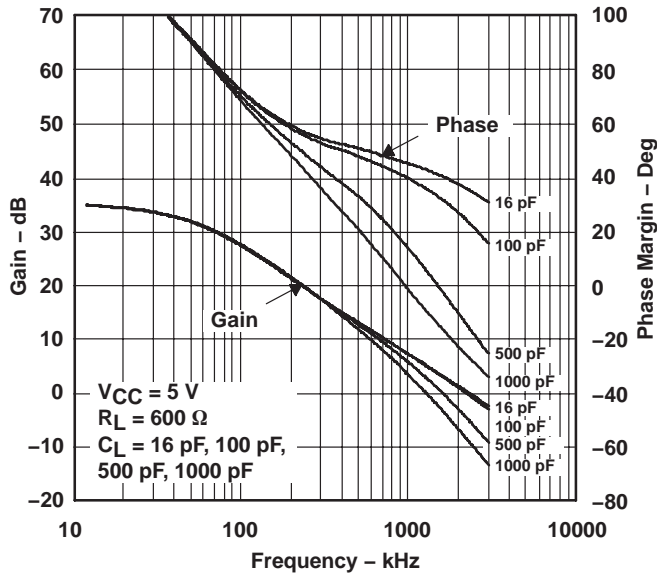

Figure 3

**GAIN AND PHASE MARGIN
VS
FREQUENCY**

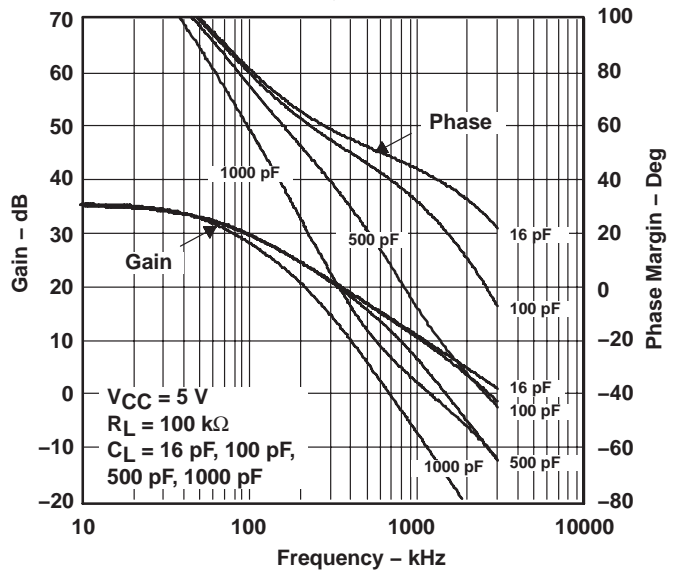

Figure 4



LMV321-Q1 SINGLE, LMV358-Q1 DUAL, LMV324-Q1 QUAD LOW-VOLTAGE RAIL-TO-RAIL OUTPUT OPERATIONAL AMPLIFIERS

SLOS415D – JUNE 2003 – REVISED OCTOBER 2004

TYPICAL CHARACTERISTICS

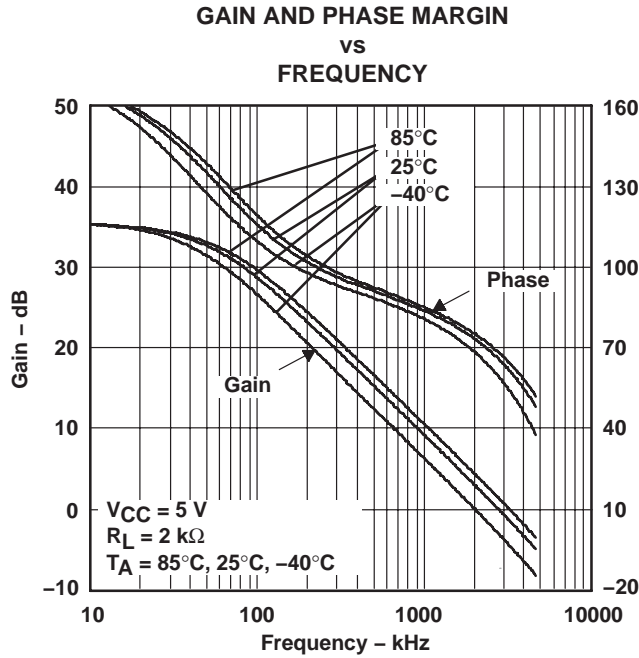

Figure 5

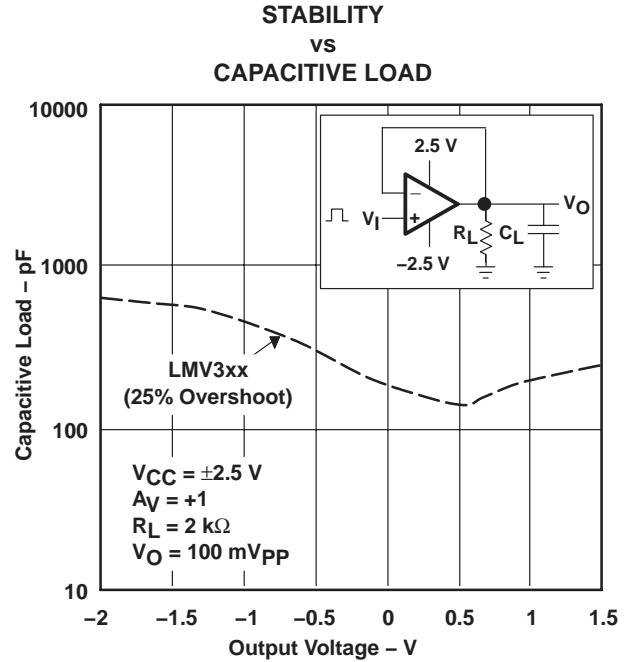

Figure 6

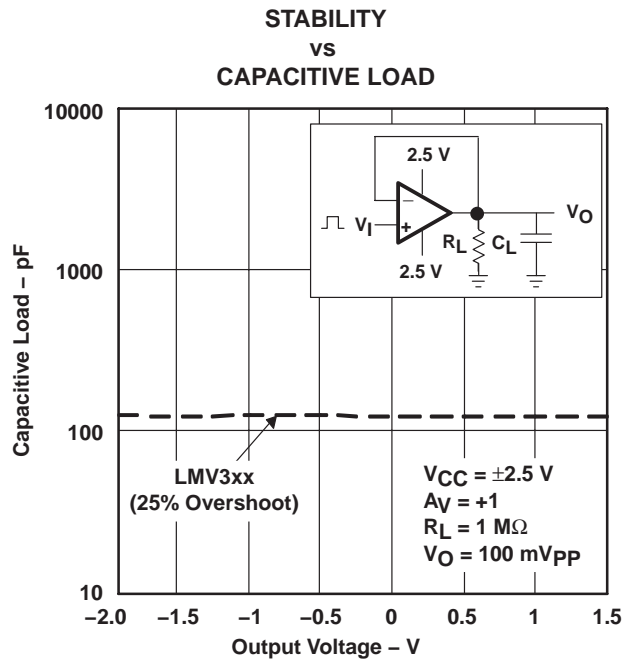

Figure 7

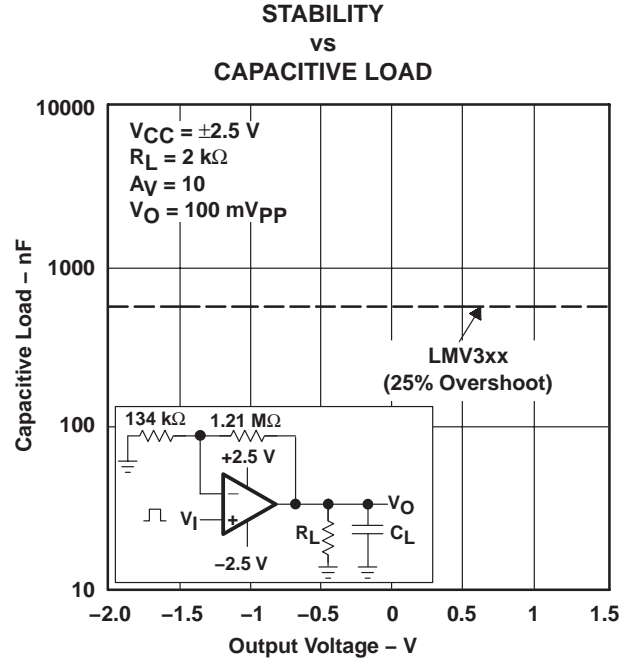
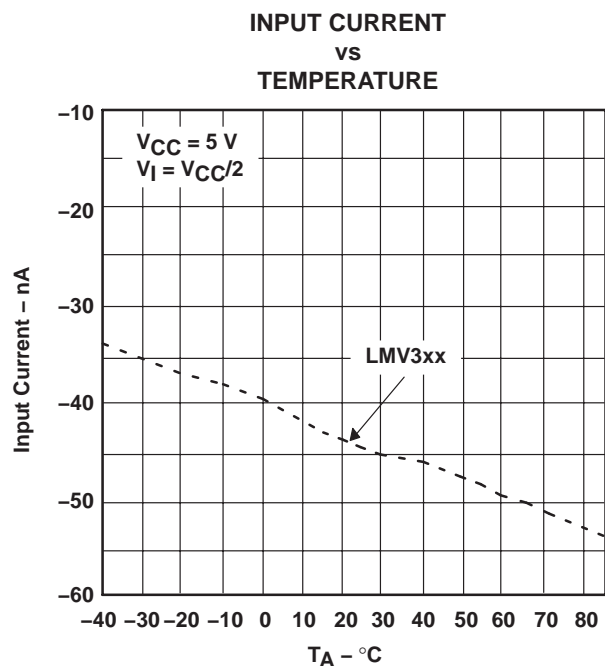
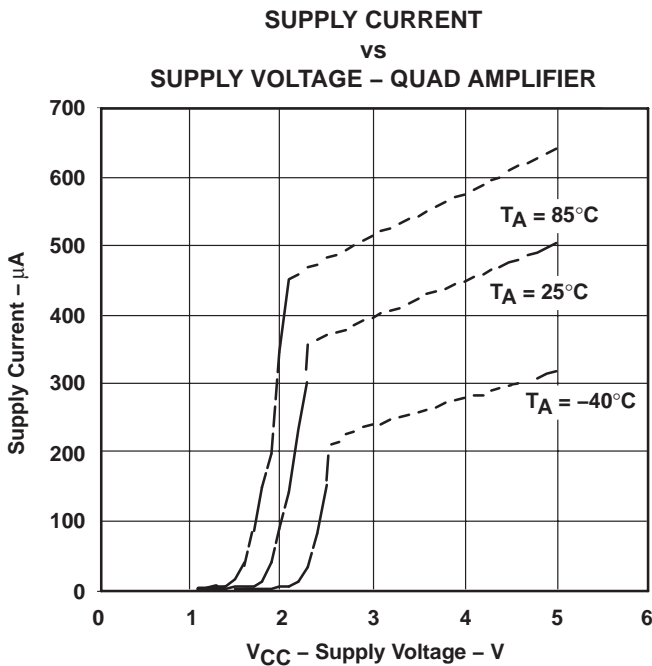
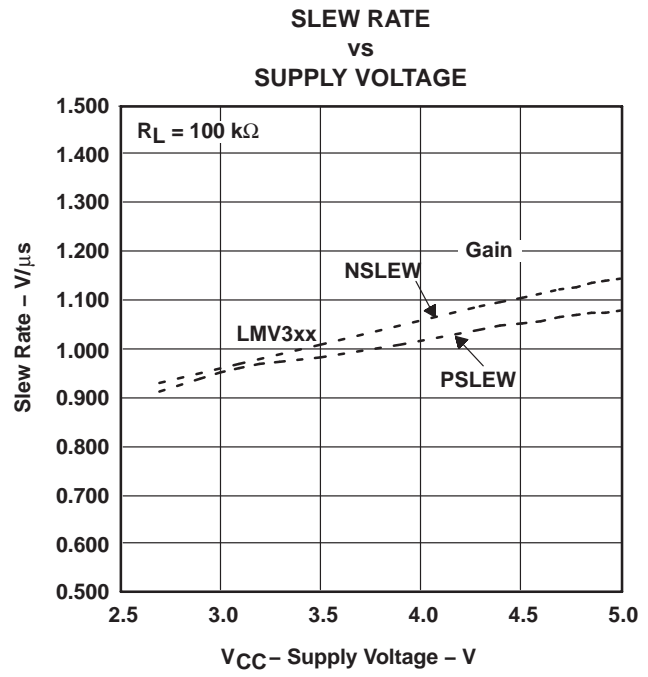
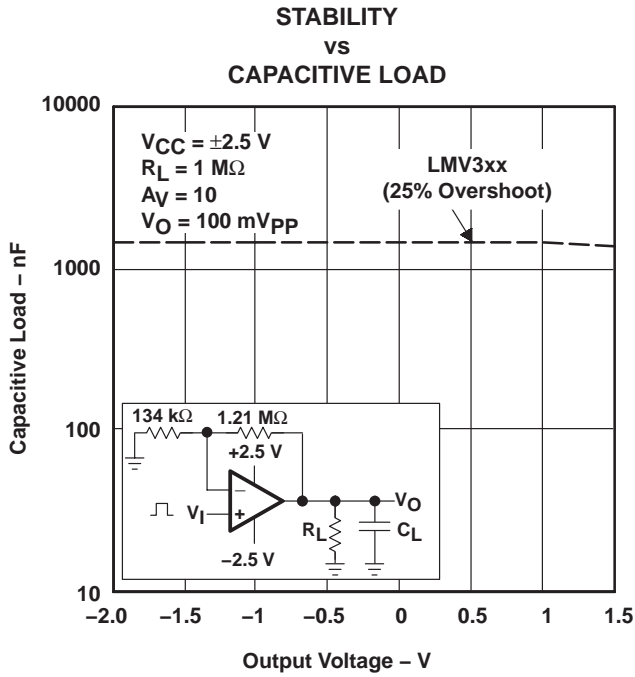

Figure 8

**LMV321-Q1 SINGLE, LMV358-Q1 DUAL, LMV324-Q1 QUAD
LOW-VOLTAGE RAIL-TO-RAIL OUTPUT
OPERATIONAL AMPLIFIERS**

SLOS415D – JUNE 2003 – REVISED OCTOBER 2004

TYPICAL CHARACTERISTICS



LMV321-Q1 SINGLE, LMV358-Q1 DUAL, LMV324-Q1 QUAD LOW-VOLTAGE RAIL-TO-RAIL OUTPUT OPERATIONAL AMPLIFIERS

SLOS415D – JUNE 2003 – REVISED OCTOBER 2004

TYPICAL CHARACTERISTICS

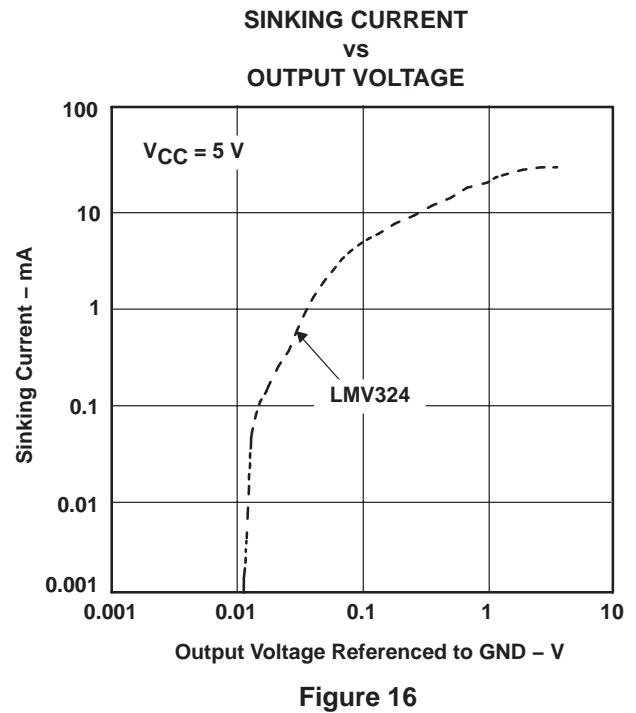
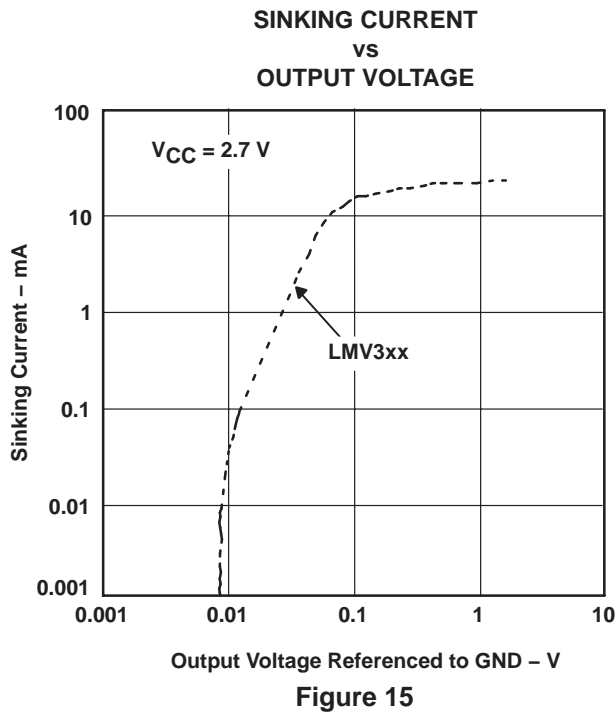
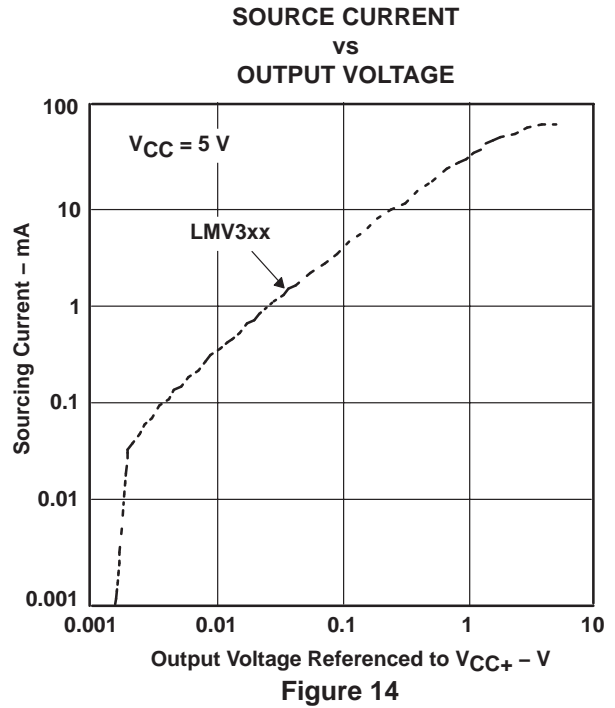
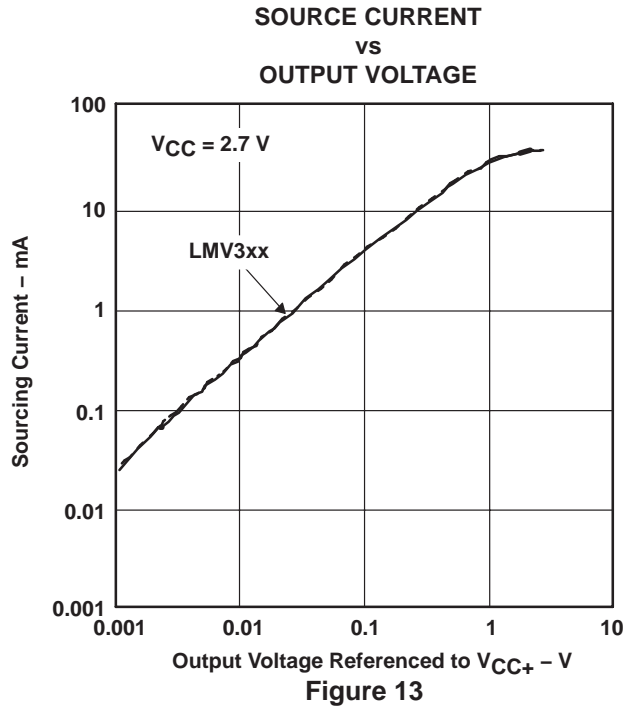

**LMV321-Q1 SINGLE, LMV358-Q1 DUAL, LMV324-Q1 QUAD
LOW-VOLTAGE RAIL-TO-RAIL OUTPUT
OPERATIONAL AMPLIFIERS**

SLOS415D – JUNE 2003 – REVISED OCTOBER 2004

TYPICAL CHARACTERISTICS

**SHORT-CIRCUIT CURRENT
vs
TEMPERATURE**

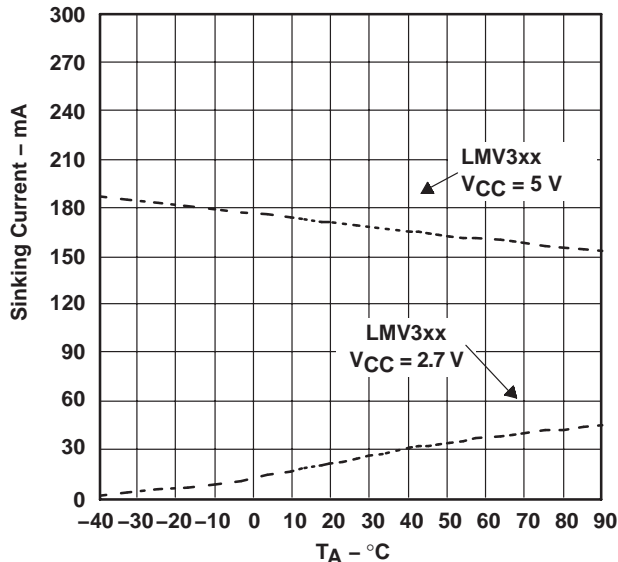

Figure 17

**SHORT-CIRCUIT CURRENT
vs
TEMPERATURE**

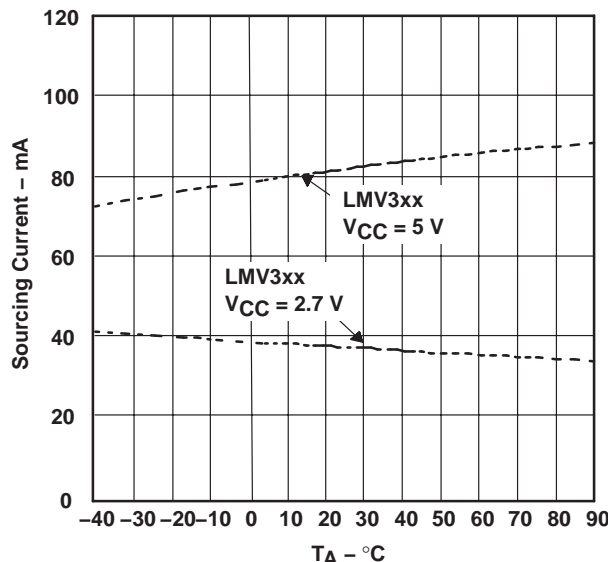

Figure 18

**-k_{SVR}
vs
FREQUENCY**

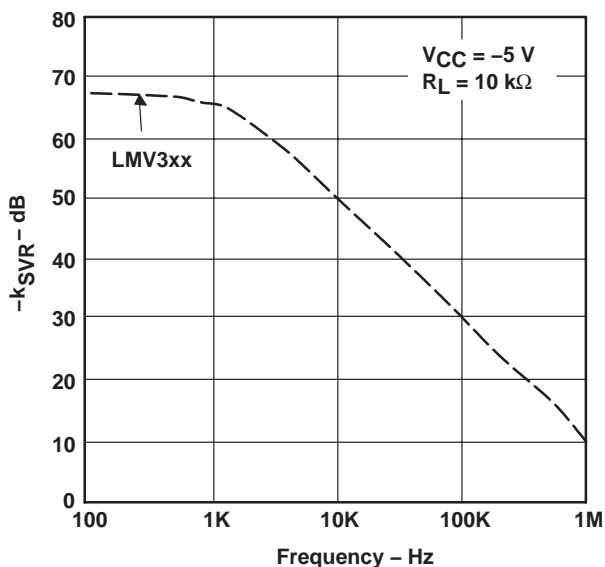

Figure 19

**+k_{SVR}
vs
FREQUENCY**

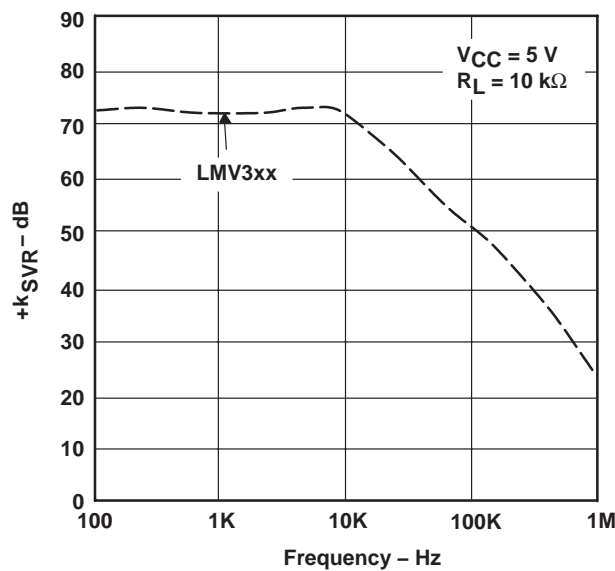

Figure 20



LMV321-Q1 SINGLE, LMV358-Q1 DUAL, LMV324-Q1 QUAD LOW-VOLTAGE RAIL-TO-RAIL OUTPUT OPERATIONAL AMPLIFIERS

SLOS415D – JUNE 2003 – REVISED OCTOBER 2004

TYPICAL CHARACTERISTICS

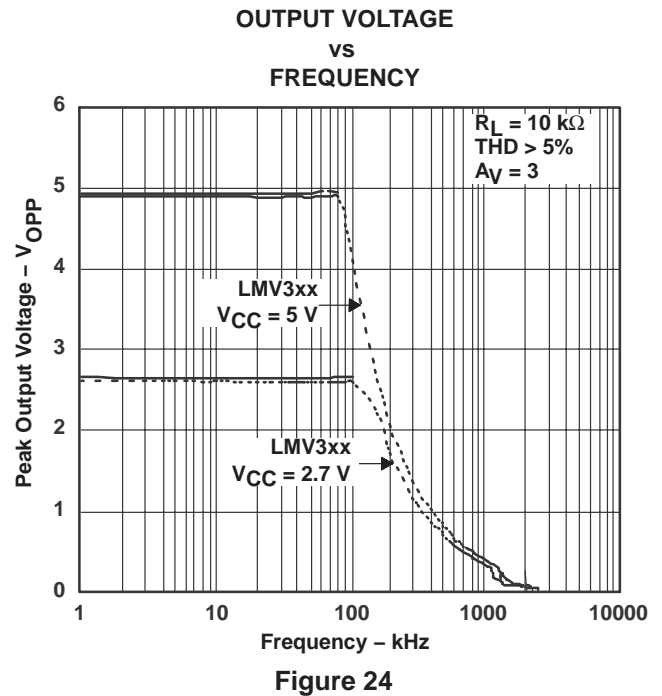
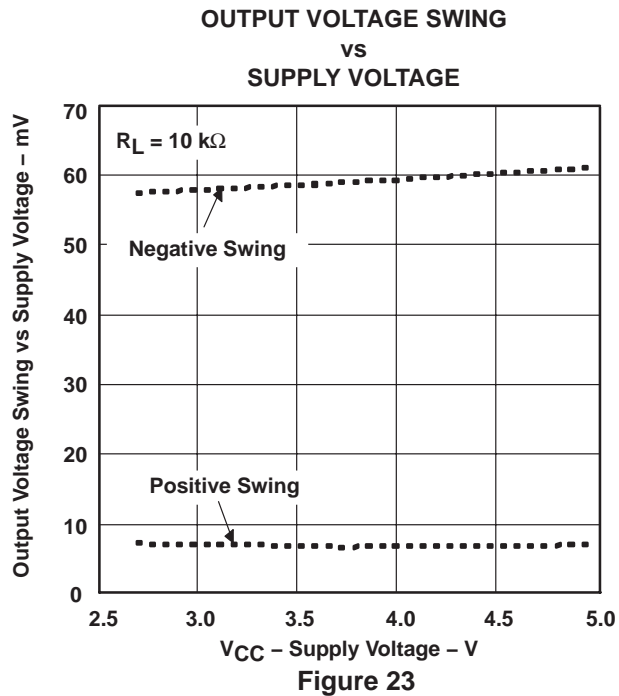
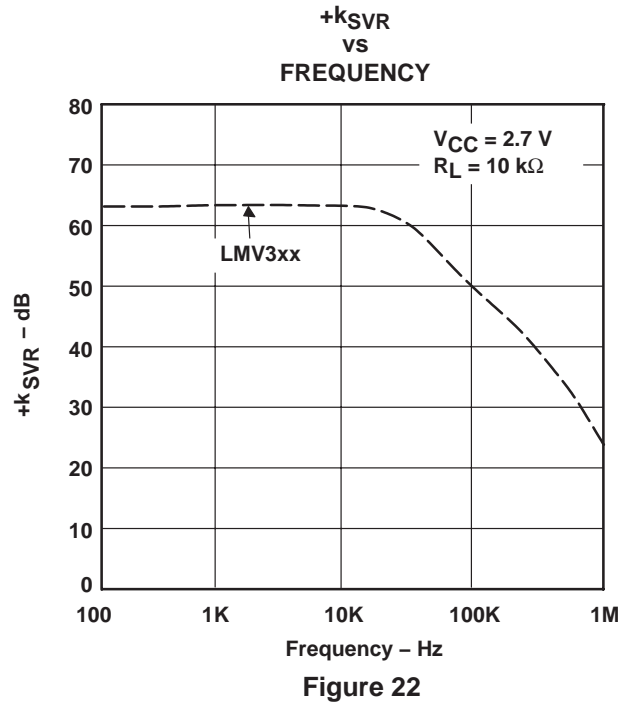
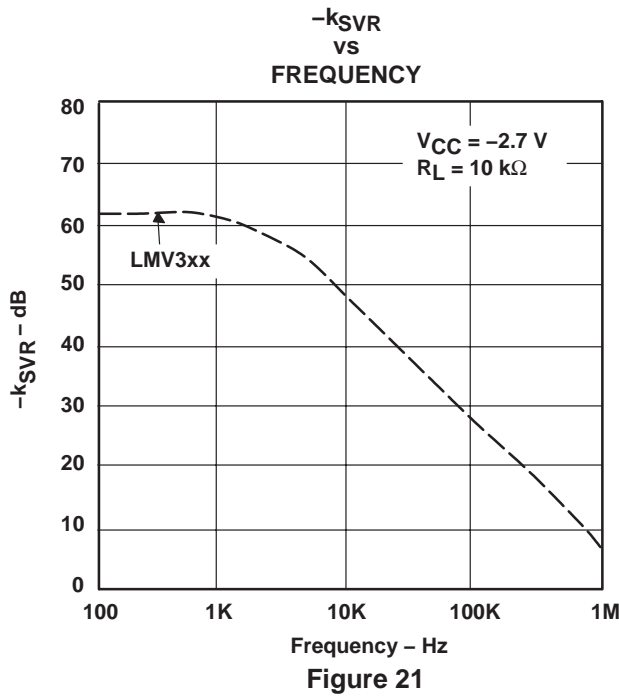

**LMV321-Q1 SINGLE, LMV358-Q1 DUAL, LMV324-Q1 QUAD
LOW-VOLTAGE RAIL-TO-RAIL OUTPUT
OPERATIONAL AMPLIFIERS**

SLOS415D – JUNE 2003 – REVISED OCTOBER 2004

TYPICAL CHARACTERISTICS

**OPEN-LOOP OUTPUT IMPEDANCE
VS
FREQUENCY**

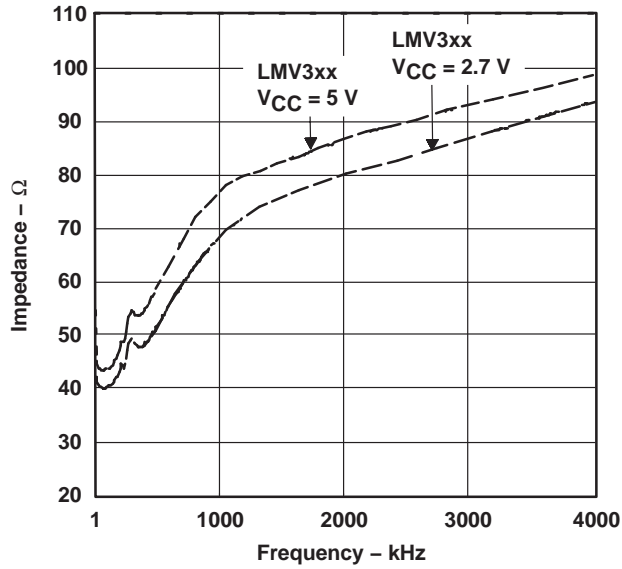

Figure 25

**CROSSTALK REJECTION
VS
FREQUENCY**

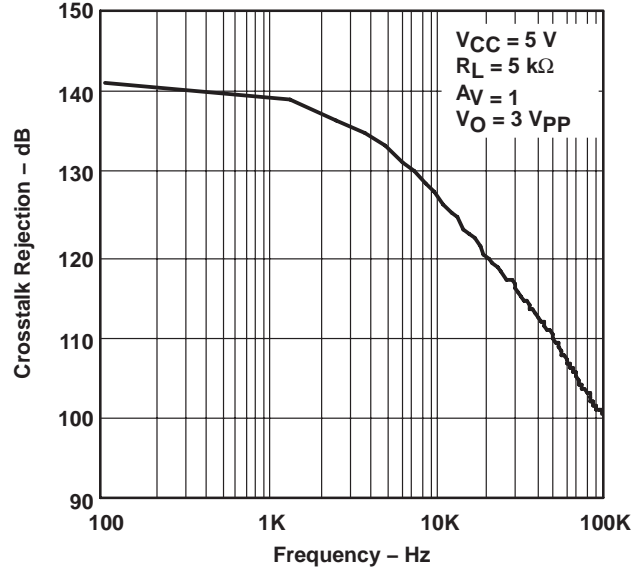

Figure 26

LMV321-Q1 SINGLE, LMV358-Q1 DUAL, LMV324-Q1 QUAD LOW-VOLTAGE RAIL-TO-RAIL OUTPUT OPERATIONAL AMPLIFIERS

SLOS415D – JUNE 2003 – REVISED OCTOBER 2004

TYPICAL CHARACTERISTICS

NONINVERTING LARGE-SIGNAL PULSE RESPONSE

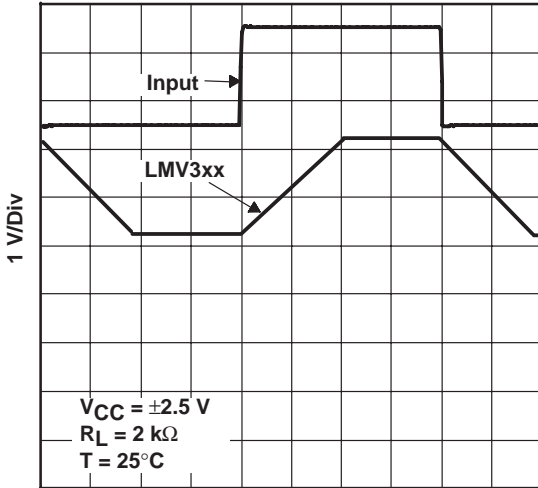

1 $\mu\text{s}/\text{Div}$
Figure 27

NONINVERTING LARGE-SIGNAL PULSE RESPONSE

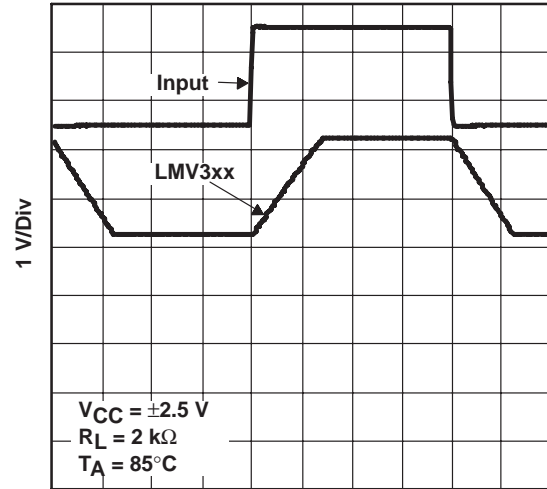

1 $\mu\text{s}/\text{Div}$
Figure 28

NONINVERTING LARGE-SIGNAL PULSE RESPONSE

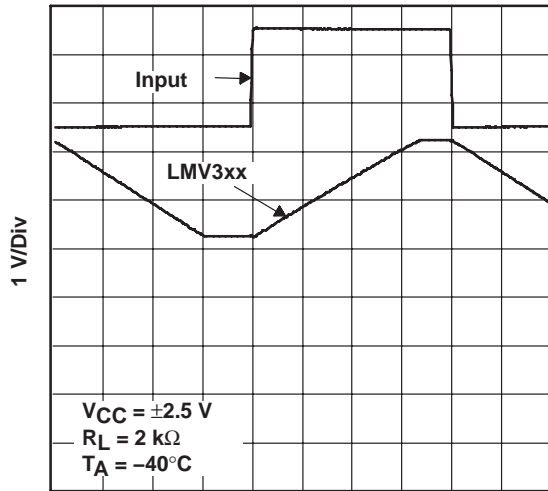

1 $\mu\text{s}/\text{Div}$
Figure 29

LMV321-Q1 SINGLE, LMV358-Q1 DUAL, LMV324-Q1 QUAD LOW-VOLTAGE RAIL-TO-RAIL OUTPUT OPERATIONAL AMPLIFIERS

SLOS415D – JUNE 2003 – REVISED OCTOBER 2004

TYPICAL CHARACTERISTICS

NONINVERTING SMALL-SIGNAL PULSE RESPONSE

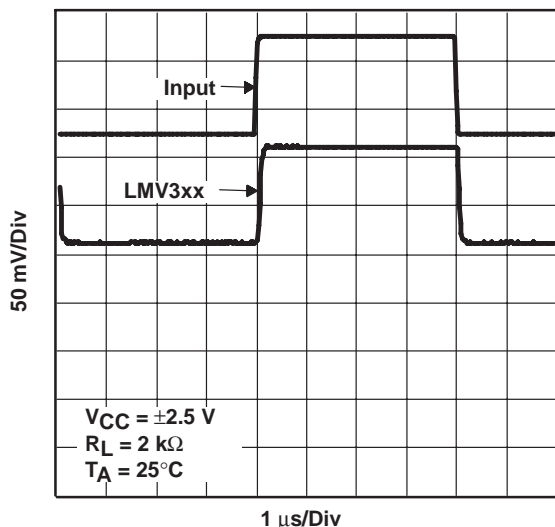

Figure 30

NONINVERTING SMALL-SIGNAL PULSE RESPONSE

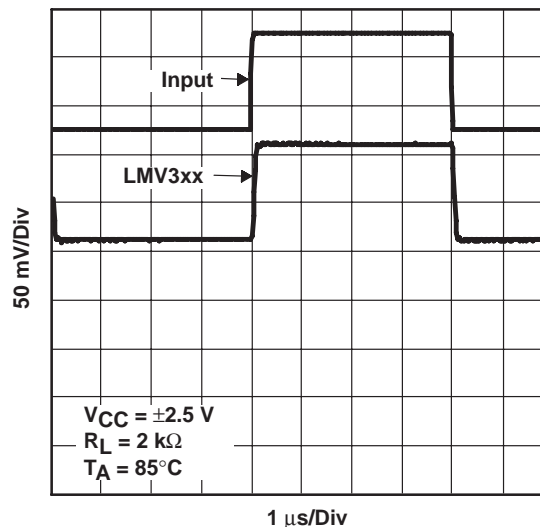

Figure 31

NONINVERTING SMALL-SIGNAL PULSE RESPONSE

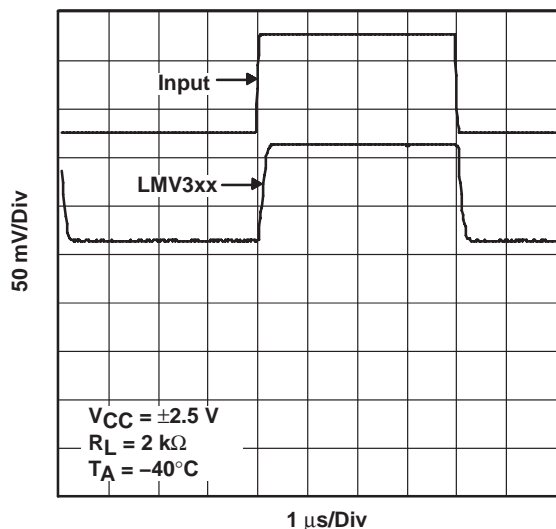

Figure 32

LMV321-Q1 SINGLE, LMV358-Q1 DUAL, LMV324-Q1 QUAD LOW-VOLTAGE RAIL-TO-RAIL OUTPUT OPERATIONAL AMPLIFIERS

SLOS415D – JUNE 2003 – REVISED OCTOBER 2004

TYPICAL CHARACTERISTICS

INVERTING LARGE-SIGNAL PULSE RESPONSE

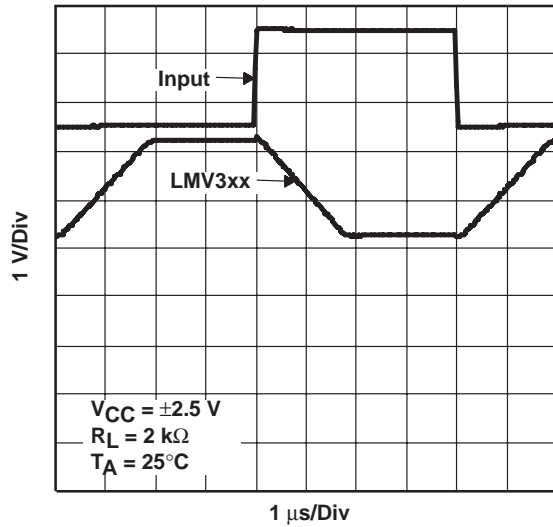

Figure 33

INVERTING LARGE-SIGNAL PULSE RESPONSE

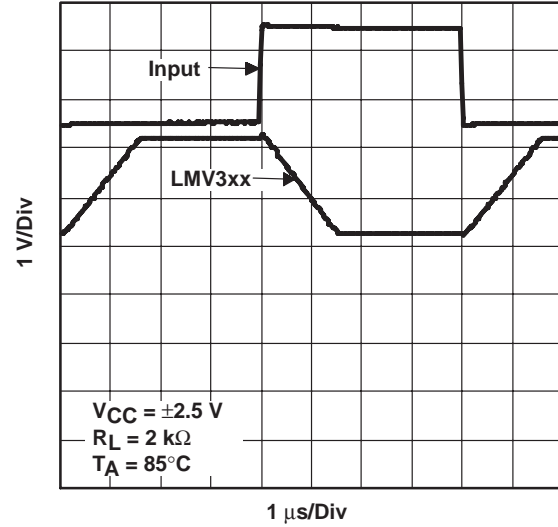

Figure 34

INVERTING LARGE-SIGNAL PULSE RESPONSE

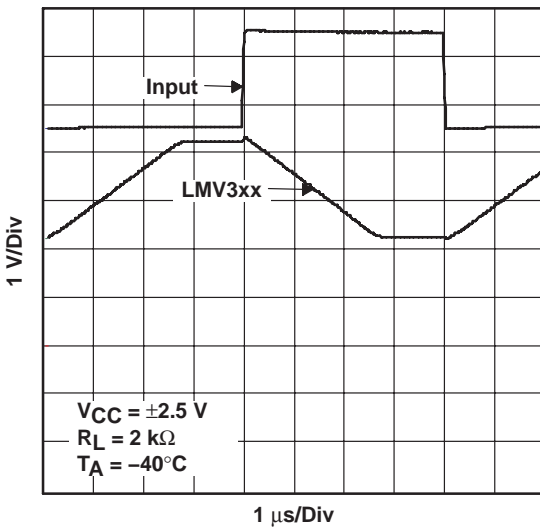

Figure 35

LMV321-Q1 SINGLE, LMV358-Q1 DUAL, LMV324-Q1 QUAD LOW-VOLTAGE RAIL-TO-RAIL OUTPUT OPERATIONAL AMPLIFIERS

SLOS415D – JUNE 2003 – REVISED OCTOBER 2004

TYPICAL CHARACTERISTICS

INVERTING SMALL-SIGNAL PULSE RESPONSE

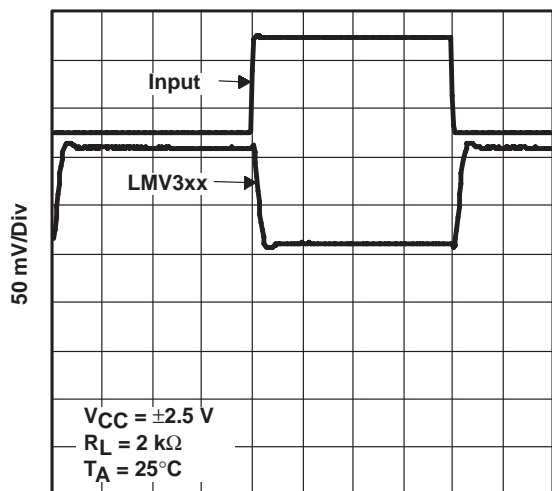

1 $\mu\text{s}/\text{Div}$
Figure 36

INVERTING SMALL-SIGNAL PULSE RESPONSE

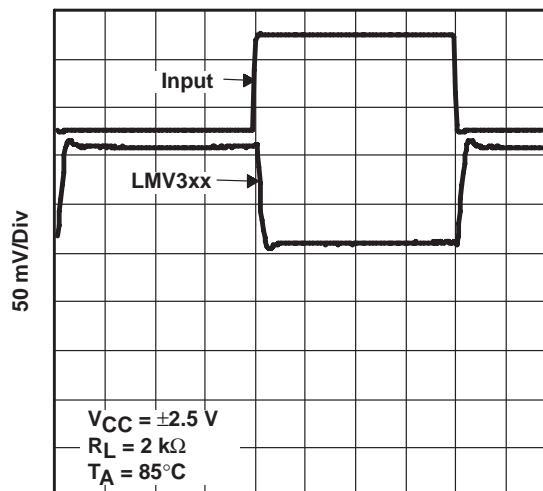

1 $\mu\text{s}/\text{Div}$
Figure 37

INVERTING SMALL-SIGNAL PULSE RESPONSE

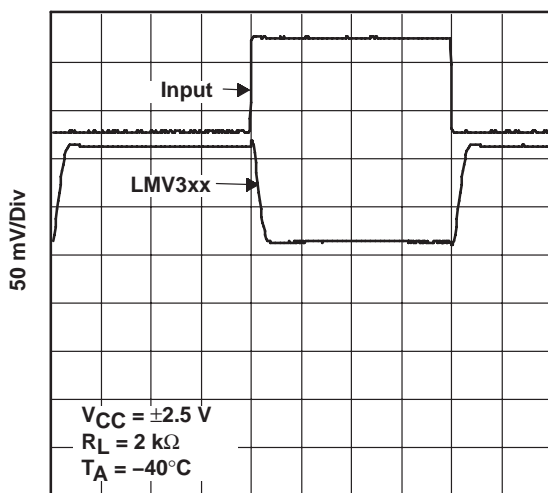

1 $\mu\text{s}/\text{Div}$
Figure 38

LMV321-Q1 SINGLE, LMV358-Q1 DUAL, LMV324-Q1 QUAD
 LOW-VOLTAGE RAIL-TO-RAIL OUTPUT
 OPERATIONAL AMPLIFIERS

SLOS415D – JUNE 2003 – REVISED OCTOBER 2004

TYPICAL CHARACTERISTICS

INPUT CURRENT NOISE
 vs
 FREQUENCY

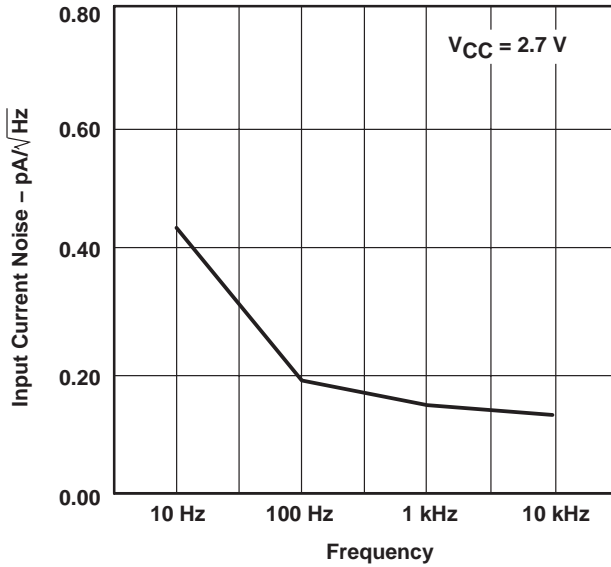

Figure 39

INPUT CURRENT NOISE
 vs
 FREQUENCY

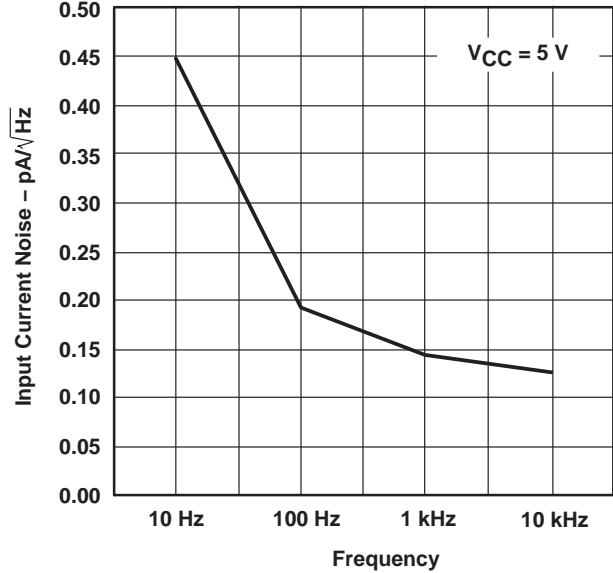

Figure 40

INPUT VOLTAGE NOISE
 vs
 FREQUENCY

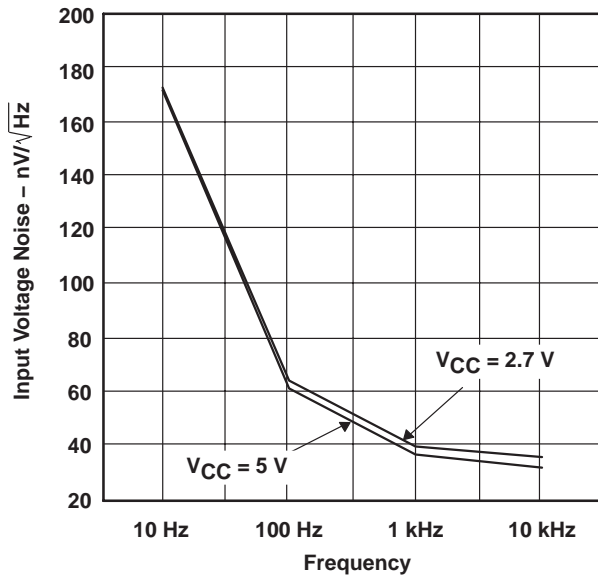
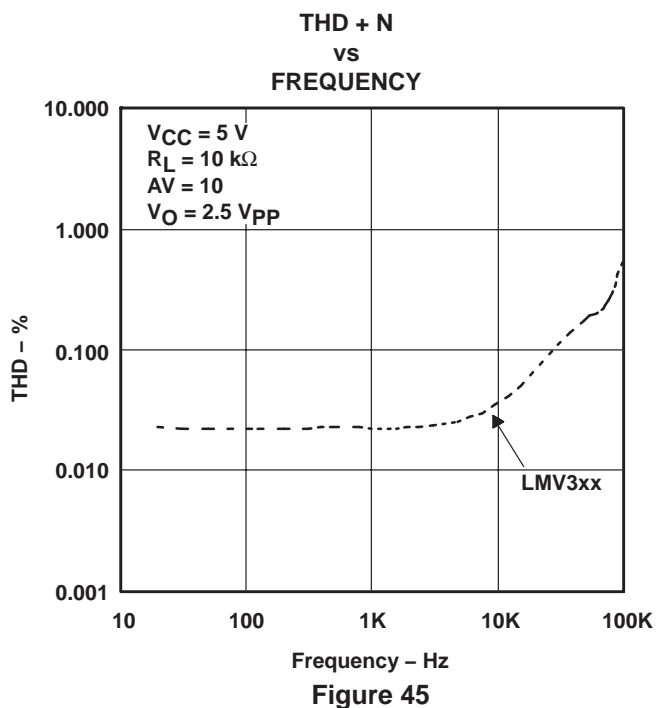
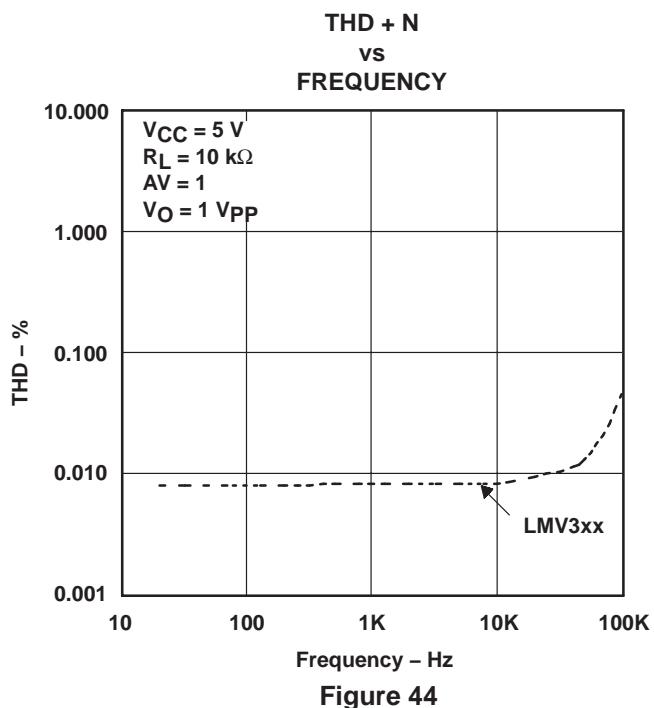
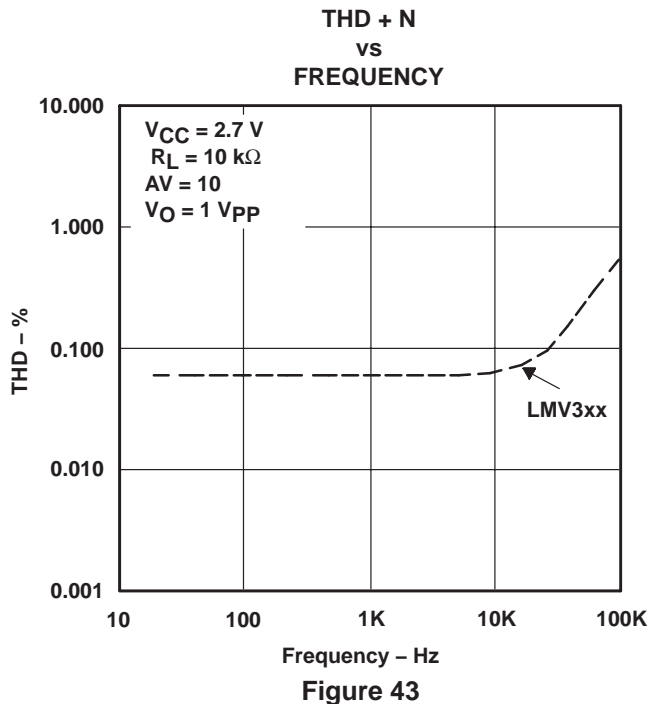
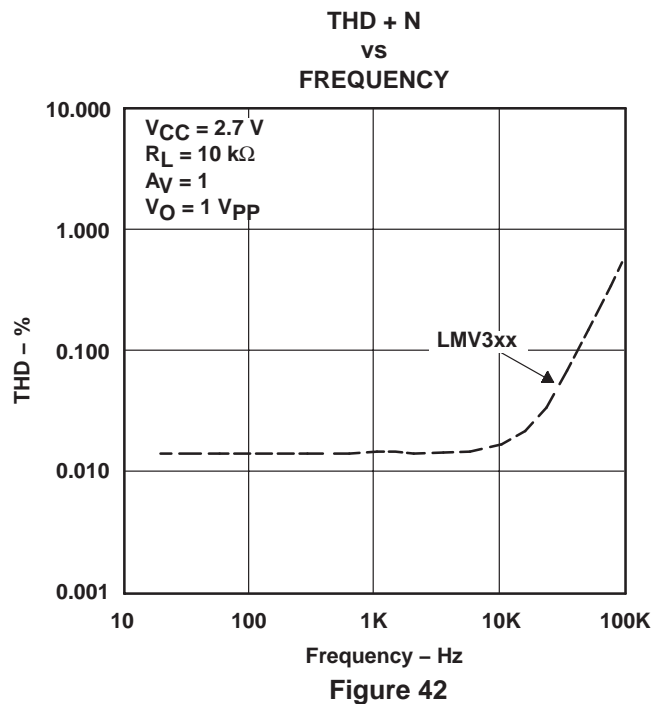

Figure 41

LMV321-Q1 SINGLE, LMV358-Q1 DUAL, LMV324-Q1 QUAD LOW-VOLTAGE RAIL-TO-RAIL OUTPUT OPERATIONAL AMPLIFIERS

SLOS415D – JUNE 2003 – REVISED OCTOBER 2004

TYPICAL CHARACTERISTICS



PACKAGING INFORMATION

Orderable Device	Status ⁽¹⁾	Package Type	Package Drawing	Pins	Package Qty	Eco Plan ⁽²⁾	Lead/Ball Finish	MSL Peak Temp ⁽³⁾
LMV324IDRQ1	ACTIVE	SOIC	D	14	2500	Pb-Free (RoHS)	CU NIPDAU	Level-2-250C-1 YEAR/ Level-1-235C-UNLIM
LMV324IPWRQ1	ACTIVE	TSSOP	PW	14	2000	None	CU NIPDAU	Level-1-250C-UNLIM
LMV324QDRQ1	ACTIVE	SOIC	D	14	2500	Pb-Free (RoHS)	CU NIPDAU	Level-2-250C-1 YEAR/ Level-1-235C-UNLIM
LMV324QPWRQ1	ACTIVE	TSSOP	PW	14	2000	None	CU NIPDAU	Level-1-250C-UNLIM
LMV358IDRQ1	ACTIVE	SOIC	D	8	2500	Pb-Free (RoHS)	CU NIPDAU	Level-2-250C-1 YEAR/ Level-1-235C-UNLIM
LMV358IPWRQ1	ACTIVE	TSSOP	PW	8	2000	None	CU NIPDAU	Level-1-250C-UNLIM
LMV358QDRQ1	ACTIVE	SOIC	D	8	2500	Pb-Free (RoHS)	CU NIPDAU	Level-2-250C-1 YEAR/ Level-1-235C-UNLIM
LMV358QPWRQ1	ACTIVE	TSSOP	PW	8	2000	None	CU NIPDAU	Level-1-250C-UNLIM

⁽¹⁾ The marketing status values are defined as follows:

ACTIVE: Product device recommended for new designs.

LIFEBUY: TI has announced that the device will be discontinued, and a lifetime-buy period is in effect.

NRND: Not recommended for new designs. Device is in production to support existing customers, but TI does not recommend using this part in a new design.

PREVIEW: Device has been announced but is not in production. Samples may or may not be available.

OBSOLETE: TI has discontinued the production of the device.

⁽²⁾ Eco Plan - May not be currently available - please check <http://www.ti.com/productcontent> for the latest availability information and additional product content details.

None: Not yet available Lead (Pb-Free).

Pb-Free (RoHS): TI's terms "Lead-Free" or "Pb-Free" mean semiconductor products that are compatible with the current RoHS requirements for all 6 substances, including the requirement that lead not exceed 0.1% by weight in homogeneous materials. Where designed to be soldered at high temperatures, TI Pb-Free products are suitable for use in specified lead-free processes.

Green (RoHS & no Sb/Br): TI defines "Green" to mean "Pb-Free" and in addition, uses package materials that do not contain halogens, including bromine (Br) or antimony (Sb) above 0.1% of total product weight.

⁽³⁾ MSL, Peak Temp. -- The Moisture Sensitivity Level rating according to the JEDEC industry standard classifications, and peak solder temperature.

Important Information and Disclaimer: The information provided on this page represents TI's knowledge and belief as of the date that it is provided. TI bases its knowledge and belief on information provided by third parties, and makes no representation or warranty as to the accuracy of such information. Efforts are underway to better integrate information from third parties. TI has taken and continues to take reasonable steps to provide representative and accurate information but may not have conducted destructive testing or chemical analysis on incoming materials and chemicals. TI and TI suppliers consider certain information to be proprietary, and thus CAS numbers and other limited information may not be available for release.

In no event shall TI's liability arising out of such information exceed the total purchase price of the TI part(s) at issue in this document sold by TI to Customer on an annual basis.

D (R-PDSO-G14)

PLASTIC SMALL-OUTLINE PACKAGE



- NOTES:
- A. All linear dimensions are in inches (millimeters).
 - B. This drawing is subject to change without notice.
 - C. Body dimensions do not include mold flash or protrusion not to exceed 0.006 (0,15).
 - D. Falls within JEDEC MS-012 variation AB.

D (R-PDSO-G8)

PLASTIC SMALL-OUTLINE PACKAGE

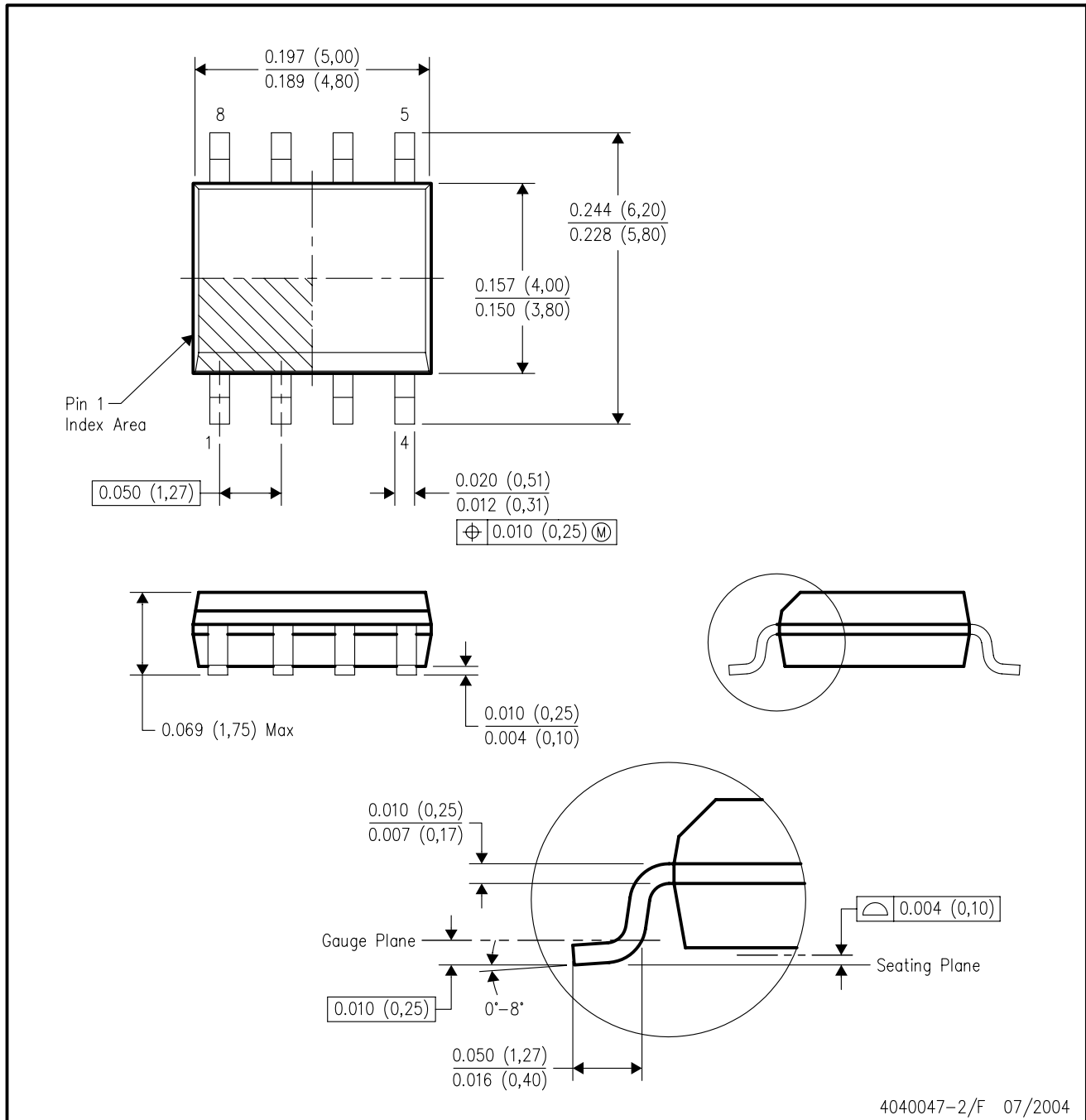

- NOTES:
- A. All linear dimensions are in inches (millimeters).
 - B. This drawing is subject to change without notice.
 - C. Body dimensions do not include mold flash or protrusion not to exceed 0.006 (0,15).
 - D. Falls within JEDEC MS-012 variation AA.

PW (R-PDSO-G**)

PLASTIC SMALL-OUTLINE PACKAGE

14 PINS SHOWN



4040064/F 01/97

- NOTES: A. All linear dimensions are in millimeters.
 B. This drawing is subject to change without notice.
 C. Body dimensions do not include mold flash or protrusion not to exceed 0,15.
 D. Falls within JEDEC MO-153

IMPORTANT NOTICE

Texas Instruments Incorporated and its subsidiaries (TI) reserve the right to make corrections, modifications, enhancements, improvements, and other changes to its products and services at any time and to discontinue any product or service without notice. Customers should obtain the latest relevant information before placing orders and should verify that such information is current and complete. All products are sold subject to TI's terms and conditions of sale supplied at the time of order acknowledgment.

TI warrants performance of its hardware products to the specifications applicable at the time of sale in accordance with TI's standard warranty. Testing and other quality control techniques are used to the extent TI deems necessary to support this warranty. Except where mandated by government requirements, testing of all parameters of each product is not necessarily performed.

TI assumes no liability for applications assistance or customer product design. Customers are responsible for their products and applications using TI components. To minimize the risks associated with customer products and applications, customers should provide adequate design and operating safeguards.

TI does not warrant or represent that any license, either express or implied, is granted under any TI patent right, copyright, mask work right, or other TI intellectual property right relating to any combination, machine, or process in which TI products or services are used. Information published by TI regarding third-party products or services does not constitute a license from TI to use such products or services or a warranty or endorsement thereof. Use of such information may require a license from a third party under the patents or other intellectual property of the third party, or a license from TI under the patents or other intellectual property of TI.

Reproduction of information in TI data books or data sheets is permissible only if reproduction is without alteration and is accompanied by all associated warranties, conditions, limitations, and notices. Reproduction of this information with alteration is an unfair and deceptive business practice. TI is not responsible or liable for such altered documentation.

Resale of TI products or services with statements different from or beyond the parameters stated by TI for that product or service voids all express and any implied warranties for the associated TI product or service and is an unfair and deceptive business practice. TI is not responsible or liable for any such statements.

Following are URLs where you can obtain information on other Texas Instruments products and application solutions:

Products		Applications	
Amplifiers	amplifier.ti.com	Audio	www.ti.com/audio
Data Converters	dataconverter.ti.com	Automotive	www.ti.com/automotive
DSP	dsp.ti.com	Broadband	www.ti.com/broadband
Interface	interface.ti.com	Digital Control	www.ti.com/digitalcontrol
Logic	logic.ti.com	Military	www.ti.com/military
Power Mgmt	power.ti.com	Optical Networking	www.ti.com/opticalnetwork
Microcontrollers	microcontroller.ti.com	Security	www.ti.com/security
		Telephony	www.ti.com/telephony
		Video & Imaging	www.ti.com/video
		Wireless	www.ti.com/wireless

Mailing Address: Texas Instruments
Post Office Box 655303 Dallas, Texas 75265