

LMV321 SINGLE, LMV358 DUAL, LMV324 QUAD, LMV324S QUAD WITH SHUTDOWN LOW-VOLTAGE RAIL-TO-RAIL OUTPUT OPERATIONAL AMPLIFIERS

SLOS263I – AUGUST 1999 – REVISED JANUARY 2003

- **2.7-V and 5-V Performance**
- **Low-Power Shutdown Mode (LMV324S)**
- **No Crossover Distortion**
- **Low Supply Current:**
 - LMV321 . . . 130 μ A Typ
 - LMV358 . . . 210 μ A Typ
 - LMV324 . . . 410 μ A Typ
 - LMV324S . . . 410 μ A Typ
- **Rail-to-Rail Output Swing**
- **ESD Protection Exceeds JESD 22**
 - 2000-V Human-Body Model (A114-A)
 - 1000-V Charged-Device Model (C101)

description/ordering information

The LMV321, LMV358, and LMV324/LMV324S are single, dual, and quad low-voltage (2.7 V to 5.5 V), operational amplifiers with rail-to-rail output swing. The LMV324S is a variation of the standard LMV324 that includes a power-saving shutdown feature that reduces supply current to a maximum of 5 μ A per channel when the amplifiers are not needed.

The LMV321, LMV358, LMV324, and LMV324S are the most cost-effective solutions for applications where low-voltage operation, space saving, and low price are needed. These amplifiers were designed specifically for low-voltage (2.7 V to 5 V) operation, with performance specifications meeting or exceeding the venerable LM358 and LM324 devices that operate from 5 V to 30 V. Additional features of the LMV3xx devices are a common-mode input voltage range that includes ground, 1-MHz unity-gain bandwidth, and 1-V/ μ s slew rate.

The LMV321 is available in the ultra-small DCK (SC-70) package, which is approximately one-half the size of the DBV (SOT-23) package. This package saves space on printed circuit boards and enables the design of small portable electronic devices. It also allows the designer to place the device closer to the signal source to reduce noise pickup and increase signal integrity.

LMV324 . . . D OR PW PACKAGE
(TOP VIEW)

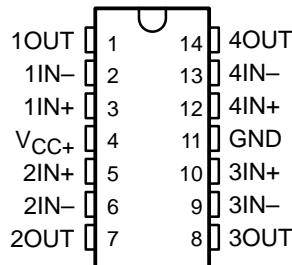

LMV324S . . . D OR PW PACKAGE
(TOP VIEW)

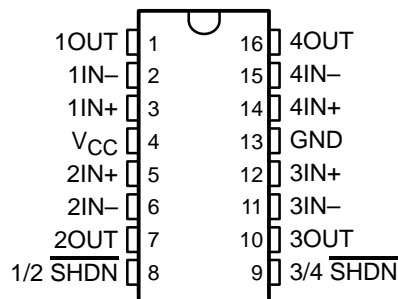

LMV358 . . . D, DGK, OR PW PACKAGE
(TOP VIEW)

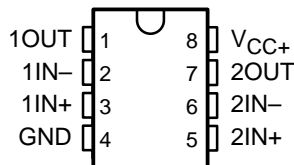

LMV321 . . . DBV OR DCK PACKAGE
(TOP VIEW)

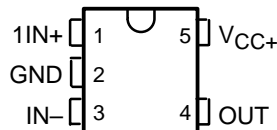

LMV321 SINGLE, LMV358 DUAL, LMV324 QUAD, LMV324S QUAD WITH SHUTDOWN LOW-VOLTAGE RAIL-TO-RAIL OUTPUT OPERATIONAL AMPLIFIERS

SLOS263I – AUGUST 1999 – REVISED JANUARY 2003

ORDERING INFORMATION

T _A		PACKAGE†		ORDERABLE PART NUMBER	TOP-SIDE MARKING‡
-40°C to 85°C	Single	SC-70 (DCK)	Reel of 3000	LMV321IDCKR	R3_
			Reel of 250	LMV321IDCKT	
		SOT23 (DBV)	Reel of 3000	LMV321IDBVR	RC1_
	Dual	MSOP/VSSOP (DGK)	Reel of 2500	LMV358IDGKR	R5S
		SOIC (D)	Tube of 75	LMV358ID	MV358I
			Reel of 2500	LMV358IDR	
	TSSOP (PW)	Reel of 2000	LMV358IPWR	MV358I	
	Quad	SOIC (D)	Tube of 50	LMV324ID	LMV324I
			Reel of 2500	LMV324IDR	
			Tube of 40	LMV324SID	LMV324SI
			Reel of 2500	LMV324SIDR	
		TSSOP (PW)	Reel of 2000	LMV324IPWR	MV324I
			LMV324SIPWR	MV324SI	

† Package drawings, standard packing quantities, thermal data, symbolization, and PCB design guidelines are available at www.ti.com/sc/package.

‡ DBV/DCK: The actual top-side marking has one additional character that designates the assembly/test site.

symbol (each amplifier)

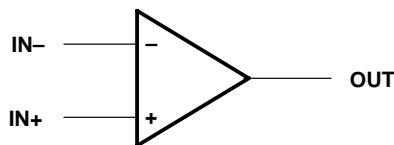

LMV321 SINGLE, LMV358 DUAL, LMV324 QUAD, LMV324S QUAD WITH SHUTDOWN LOW-VOLTAGE RAIL-TO-RAIL OUTPUT OPERATIONAL AMPLIFIERS

SLOS263I – AUGUST 1999 – REVISED JANUARY 2003

absolute maximum ratings over operating free-air temperature range (unless otherwise noted)†

Supply voltage, V_{CC} (see Note 1)	5.5 V
Differential input voltage, V_{ID} (see Note 2)	± 5.5 V
Input voltage, V_I (either input)	0 to 5.5 V
Duration of output short circuit (one amplifier) to ground at (or below) $T_A = 25^\circ\text{C}$, $V_{CC} \leq 5.5$ V (see Note 3)	Unlimited
Operating virtual junction temperature	150°C
Package thermal impedance, θ_{JA} (see Notes 4 and 5):	
D (8-pin) package	97°C/W
D (14-pin) package	86°C/W
D (16-pin) package	73°C/W
DBV package	206°C/W
DCK package	252°C/W
DGK package	172°C/W
PW (8-pin) package	149°C/W
PW (14-pin) package	113°C/W
PW (16-pin) package	108°C/W
Storage temperature range, T_{stg}	-65 to 150°C

† Stresses beyond those listed under “absolute maximum ratings” may cause permanent damage to the device. These are stress ratings only, and functional operation of the device at these or any other conditions beyond those indicated under “recommended operating conditions” is not implied. Exposure to absolute-maximum-rated conditions for extended periods may affect device reliability.

- NOTES:
- All voltage values (except differential voltages and V_{CC} specified for the measurement of I_{OS}) are with respect to the network GND.
 - Differential voltages are at $IN+$ with respect to $IN-$.
 - Short circuits from outputs to V_{CC} can cause excessive heating and eventual destruction.
 - Maximum power dissipation is a function of $T_J(\text{max})$, θ_{JA} , and T_A . The maximum allowable power dissipation at any allowable ambient temperature is $P_D = (T_J(\text{max}) - T_A)/\theta_{JA}$. Selecting the maximum of 150°C can affect reliability.
 - The package thermal impedance is calculated in accordance with JESD 51-7.

recommended operating conditions (see Note 6)

		MIN	MAX	UNIT
V_{CC}	Supply voltage (single-supply operation)	2.7	5.5	V
V_{IH}	Amplifier turn-on voltage level (LMV324S)‡	$V_{CC} = 2.7$ V	1.7	V
		$V_{CC} = 5$ V	3.5	
V_{IL}	Amplifier turn-off voltage level (LMV324S)	$V_{CC} = 2.7$ V	0.7	V
		$V_{CC} = 5$ V	1.5	
T_A	Operating free-air temperature	-40	85	°C

‡ V_{IH} should not be allowed to exceed V_{CC} .

NOTE 6: All unused control inputs of the device must be held at V_{CC} or GND to ensure proper device operation. Refer to the TI application report, *Implications of Slow or Floating CMOS Inputs*, literature number SCBA004.



LMV321 SINGLE, LMV358 DUAL, LMV324 QUAD, LMV324S QUAD WITH SHUTDOWN LOW-VOLTAGE RAIL-TO-RAIL OUTPUT OPERATIONAL AMPLIFIERS

SLOS263I – AUGUST 1999 – REVISED JANUARY 2003

electrical characteristics at $T_A = 25^\circ\text{C}$ and $V_{CC+} = 2.7\text{ V}$ (unless otherwise noted)

PARAMETER		TEST CONDITIONS	MIN	TYP	MAX	UNIT
V_{IO}	Input offset voltage			1.7	7	mV
$\alpha_{V_{IO}}$	Average temperature coefficient of input offset voltage			5		$\mu\text{V}/^\circ\text{C}$
I_{IB}	Input bias current			11	250	nA
I_{IO}	Input offset current			5	50	nA
CMRR	Common-mode rejection ratio	$V_{CM} = 0$ to 1.7 V	50	63		dB
kSVR	Supply-voltage rejection ratio	$V_{CC} = 2.7\text{ V}$ to 5 V , $V_O = 1\text{ V}$	50	60		dB
V_{ICR}	Common-mode input voltage range	CMRR $\geq 50\text{ dB}$	0 to 1.7	-0.2 to 1.9		V
Output swing		$R_L = 10\text{ k}\Omega$ to 1.35 V	High level	$V_{CC}-100$	$V_{CC}-10$	mV
			Low level		60	
I_{CC}	Supply current	LMV321I		80	170	μA
		LMV358I (both amplifiers)		140	340	
		LMV324I/LMV324SI (all four amplifiers)		260	680	
B_1	Unity-gain bandwidth	$C_L = 200\text{ pF}$		1		MHz
Φ_m	Phase margin			60		deg
G_m	Gain margin			10		dB
V_n	Equivalent input noise voltage	$f = 1\text{ kHz}$		46		$\text{nV}/\sqrt{\text{Hz}}$
I_n	Equivalent input noise current	$f = 1\text{ kHz}$		0.17		$\text{pA}/\sqrt{\text{Hz}}$

shutdown characteristics (LMV324S) at $T_A = 25^\circ\text{C}$ and $V_{CC+} = 2.7\text{ V}$ (unless otherwise noted)

PARAMETER		TEST CONDITIONS	MIN	TYP	MAX	UNIT
$I_{CC}(\text{SHDN})$	Supply current in shutdown mode (per channel)	$\overline{\text{SHDN}} \leq 0.6\text{ V}$			5	μA
$t_{(\text{on})}$	Amplifier turn-on time	$A_V = 1$, $R_L = \text{Open}$ (measured at 50% point)		2		μs
$t_{(\text{off})}$	Amplifier turn-off time	$A_V = 1$, $R_L = \text{Open}$ (measured at 50% point)		40		ns



LMV321 SINGLE, LMV358 DUAL, LMV324 QUAD, LMV324S QUAD WITH SHUTDOWN LOW-VOLTAGE RAIL-TO-RAIL OUTPUT OPERATIONAL AMPLIFIERS

SLOS263I – AUGUST 1999 – REVISED JANUARY 2003

electrical characteristics at specified free-air temperature range, $V_{CC+} = 5\text{ V}$ (unless otherwise noted)

PARAMETER		TEST CONDITIONS	T_A	MIN	TYP	MAX	UNIT
V_{IO}	Input offset voltage		25°C		1.7	7	mV
			-40°C to 85°C			9	
$\alpha_{V_{IO}}$	Average temperature coefficient of input offset voltage		25°C		5		$\mu\text{V}/^\circ\text{C}$
I_{IB}	Input bias current		25°C		15	250	nA
			-40°C to 85°C			500	
I_{IO}	Input offset current		25°C		5	50	nA
			-40°C to 85°C			150	
CMRR	Common-mode rejection ratio	$V_{CM} = 0$ to 4 V	25°C	50	65		dB
kSVR	Supply-voltage rejection ratio	$V_{CC} = 2.7\text{ V}$ to 5 V, $V_O = 1\text{ V}$, $V_{CM} = 1\text{ V}$	25°C	50	60		dB
V_{ICR}	Common-mode input voltage range	CMMR $\geq 50\text{ dB}$	25°C	0 to 4	-0.2 to 4.2		V
Output swing	$R_L = 2\text{ k}\Omega$ to 2.5 V	High level	25°C	$V_{CC}-300$	$V_{CC}-40$		mV
			-40°C to 85°C	$V_{CC}-400$			
		Low level	25°C		120	300	
			-40°C to 85°C			400	
	$R_L = 10\text{ k}\Omega$ to 2.5 V	High level	25°C	$V_{CC}-100$	$V_{CC}-10$		
			-40°C to 85°C	$V_{CC}-200$			
		Low level	25°C		65	180	
			-40°C to 85°C			280	
AVD	Large-signal differential voltage gain	$R_L = 2\text{ k}\Omega$	25°C	15	100		V/mV
			-40°C to 85°C	10			
I_{OS}	Output short-circuit current	Sourcing, $V_O = 0\text{ V}$	25°C	5	60		mA
		Sinking, $V_O = 5\text{ V}$		10	160		
I_{CC}	Supply current	LMV321I	25°C		130	250	μA
			-40°C to 85°C			350	
		LMV358I (both amplifiers)	25°C		210	440	
			-40°C to 85°C			615	
		LMV324I/LMV324SI (all four amplifiers)	25°C		410	830	
			-40°C to 85°C			1160	
B_1	Unity-gain bandwidth	$C_L = 200\text{ pF}$	25°C		1		MHz
ϕ_m	Phase margin		25°C		60		deg
G_m	Gain margin		25°C		10		dB
V_n	Equivalent input noise voltage	$f = 1\text{ kHz}$	25°C		39		$\text{nV}/\sqrt{\text{Hz}}$
I_n	Equivalent input noise current	$f = 1\text{ kHz}$	25°C		0.21		$\text{pA}/\sqrt{\text{Hz}}$
SR	Slew rate		25°C		1		$\text{V}/\mu\text{s}$

shutdown characteristics (LMV324S) at $T_A = 25^\circ\text{C}$ and $V_{CC+} = 5\text{ V}$ (unless otherwise noted)

PARAMETER		TEST CONDITIONS	T_A	MIN	TYP	MAX	UNIT
$I_{CC}(\text{SHDN})$	Supply current in shutdown mode (per channel)	$\overline{\text{SHDN}} \leq 0.6\text{ V}$	-40°C to 85°C			5	μA
$t_{(on)}$	Amplifier turn-on time	$A_V = 1$, $R_L = \text{Open}$ (measured at 50% point)			2		μs
$t_{(off)}$	Amplifier turn-off time	$A_V = 1$, $R_L = \text{Open}$ (measured at 50% point)			40		ns



LMV321 SINGLE, LMV358 DUAL, LMV324 QUAD, LMV324S QUAD WITH SHUTDOWN LOW-VOLTAGE RAIL-TO-RAIL OUTPUT OPERATIONAL AMPLIFIERS

SLOS263I – AUGUST 1999 – REVISED JANUARY 2003

TYPICAL CHARACTERISTICS

**GAIN AND PHASE MARGIN
vs
FREQUENCY**

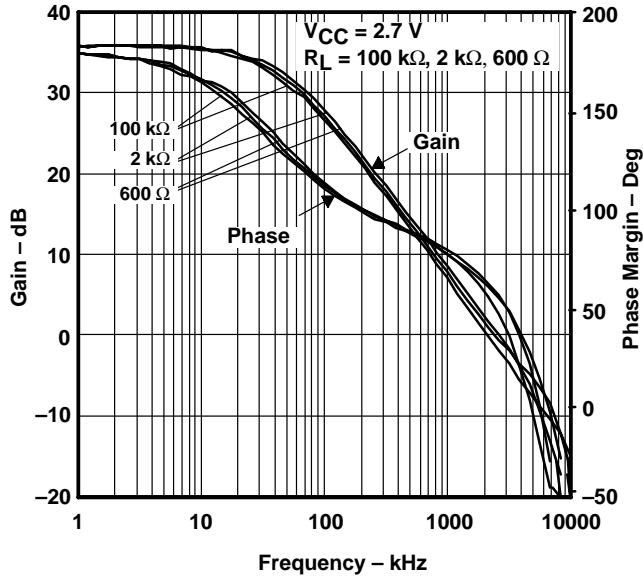

Figure 1

**GAIN AND PHASE MARGIN
vs
FREQUENCY**

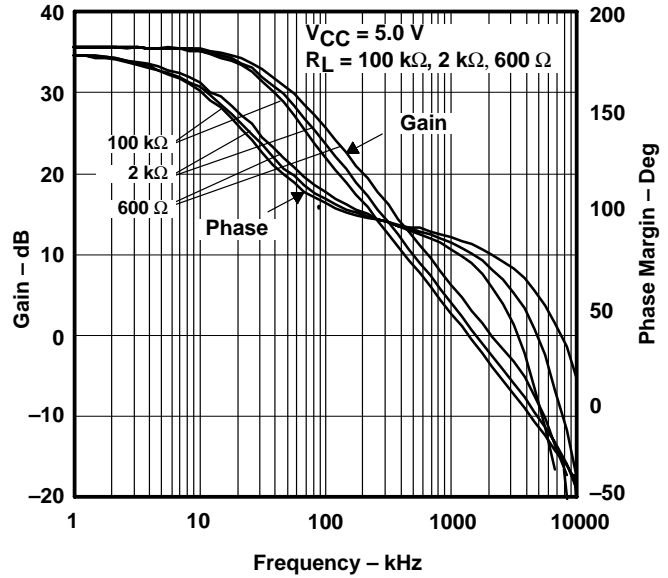

Figure 2

**GAIN AND PHASE MARGIN
vs
FREQUENCY**

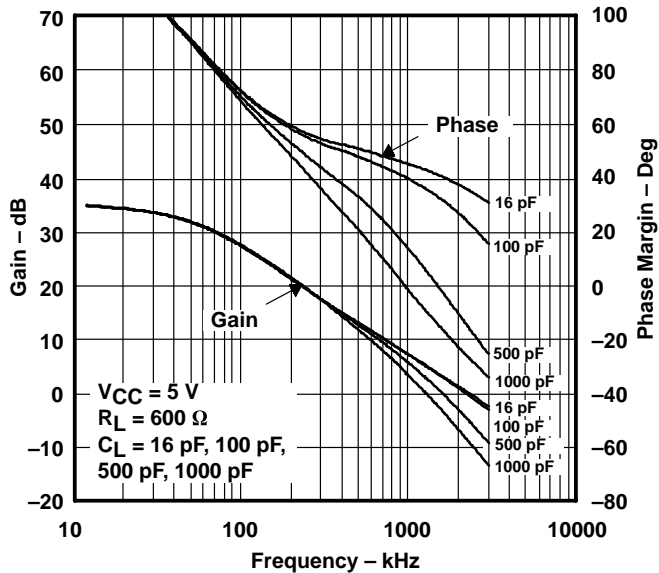

Figure 3

**GAIN AND PHASE MARGIN
vs
FREQUENCY**

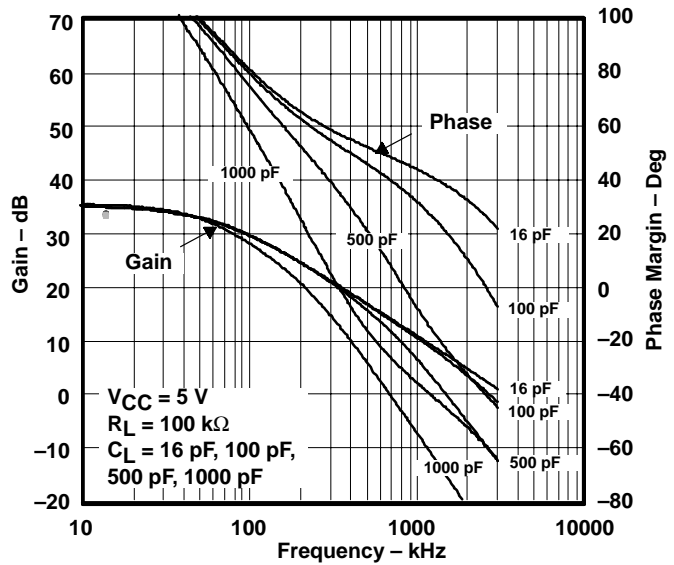

Figure 4



LMV321 SINGLE, LMV358 DUAL, LMV324 QUAD, LMV324S QUAD WITH SHUTDOWN LOW-VOLTAGE RAIL-TO-RAIL OUTPUT OPERATIONAL AMPLIFIERS

SLOS2631 – AUGUST 1999 – REVISED JANUARY 2003

TYPICAL CHARACTERISTICS

**GAIN AND PHASE MARGIN
vs
FREQUENCY**

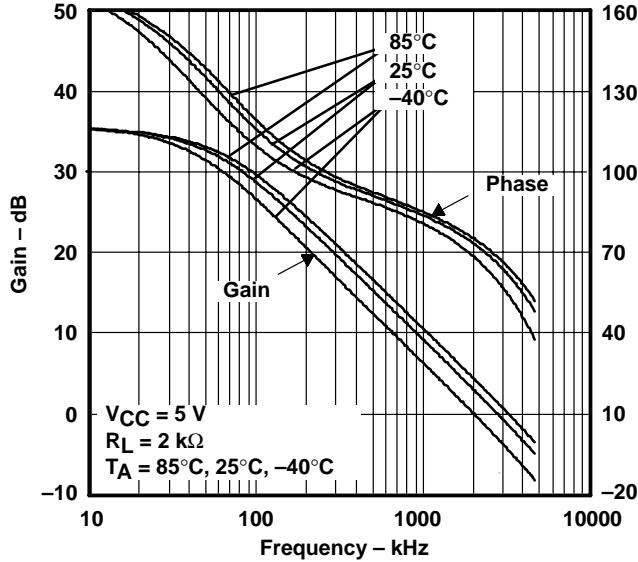

Figure 5

**STABILITY
vs
CAPACITIVE LOAD**

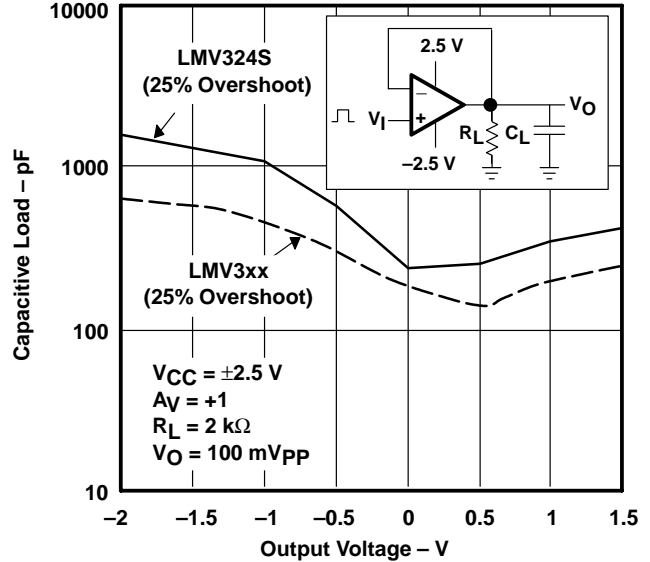

Figure 6

**STABILITY
vs
CAPACITIVE LOAD**

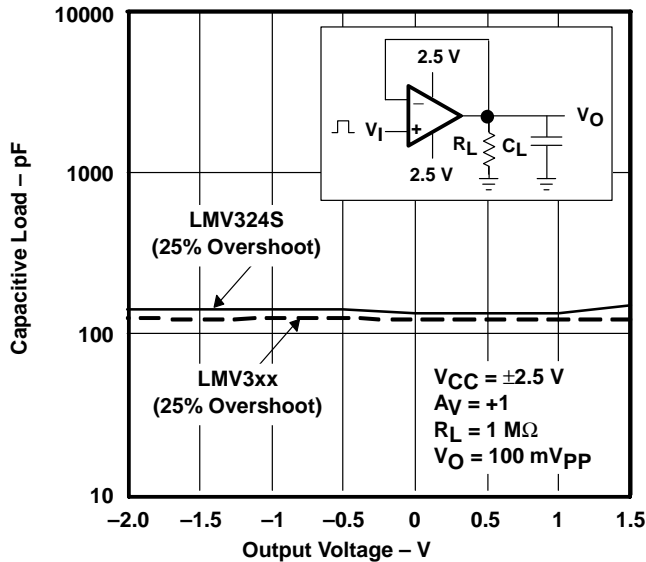

Figure 7

**STABILITY
vs
CAPACITIVE LOAD**

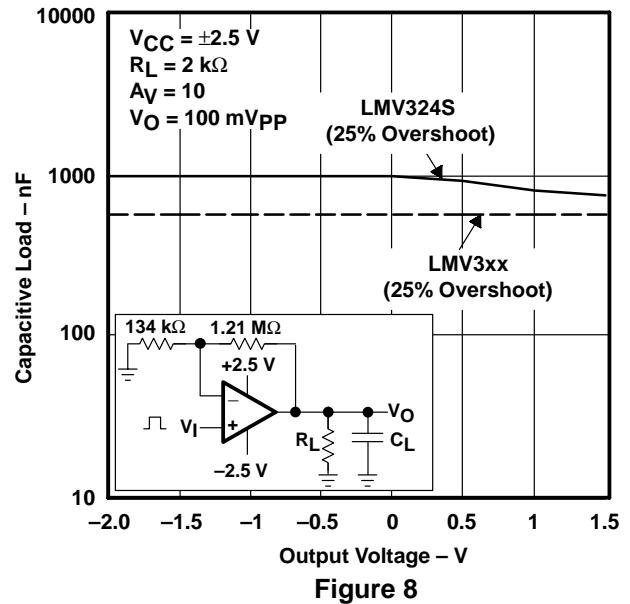

Figure 8

LMV321 SINGLE, LMV358 DUAL, LMV324 QUAD, LMV324S QUAD WITH SHUTDOWN LOW-VOLTAGE RAIL-TO-RAIL OUTPUT OPERATIONAL AMPLIFIERS

SLOS263I – AUGUST 1999 – REVISED JANUARY 2003

TYPICAL CHARACTERISTICS

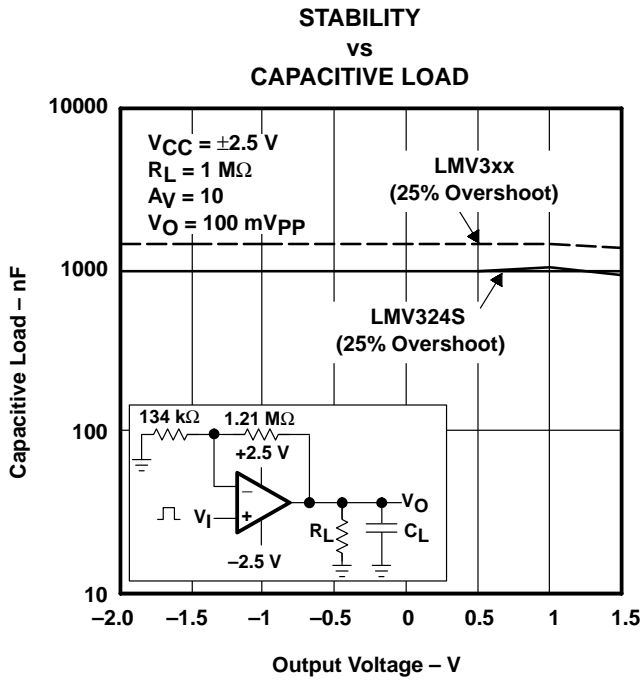

Figure 9

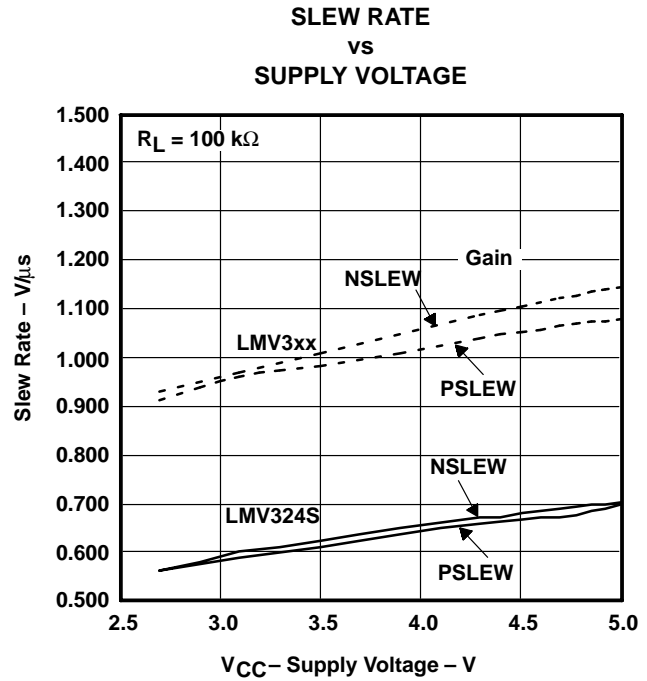

Figure 10

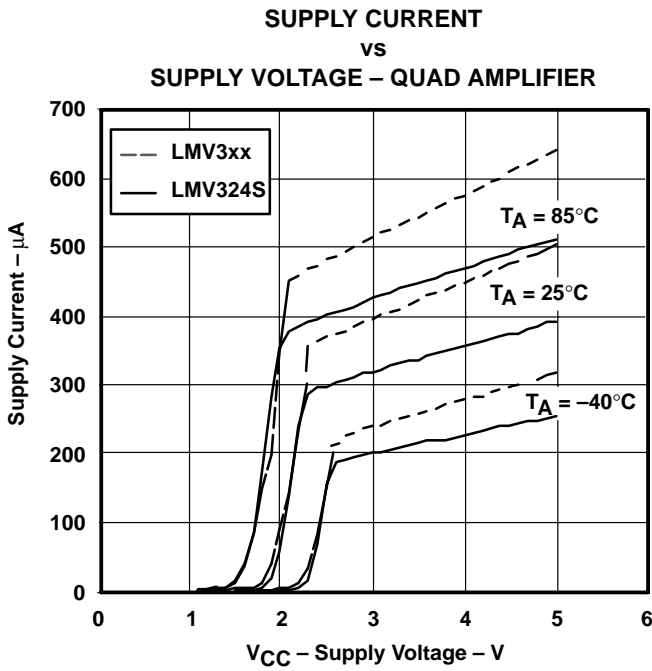

Figure 11

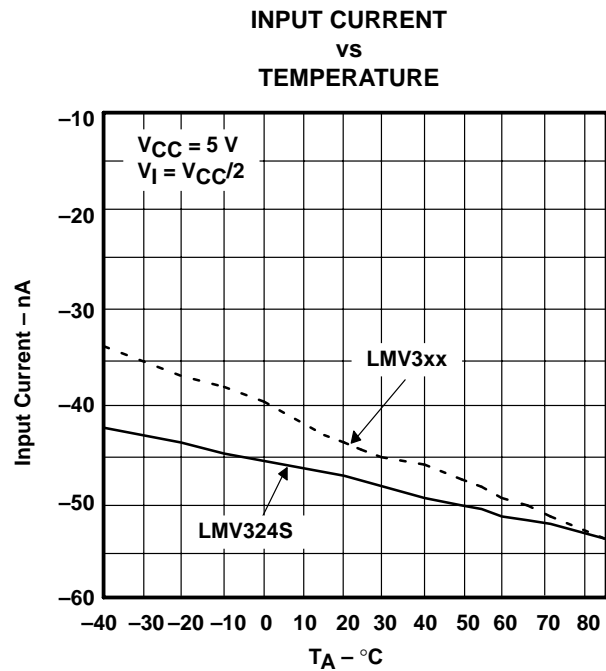
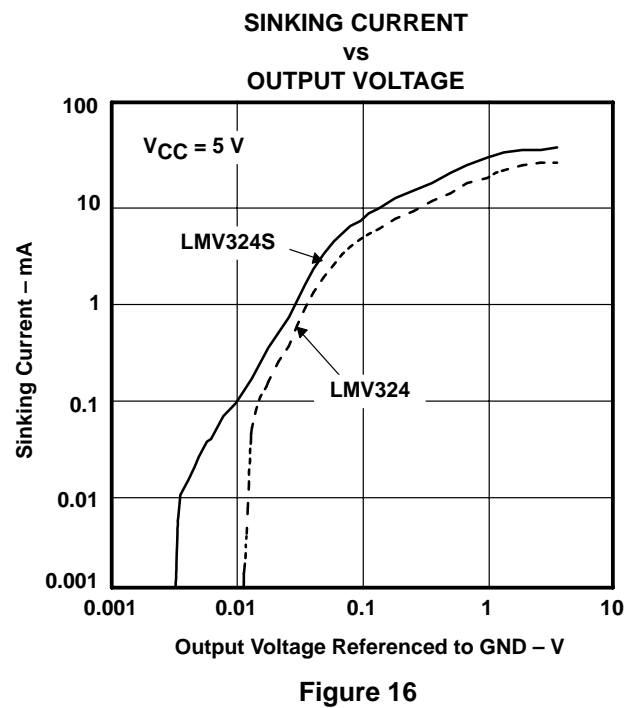
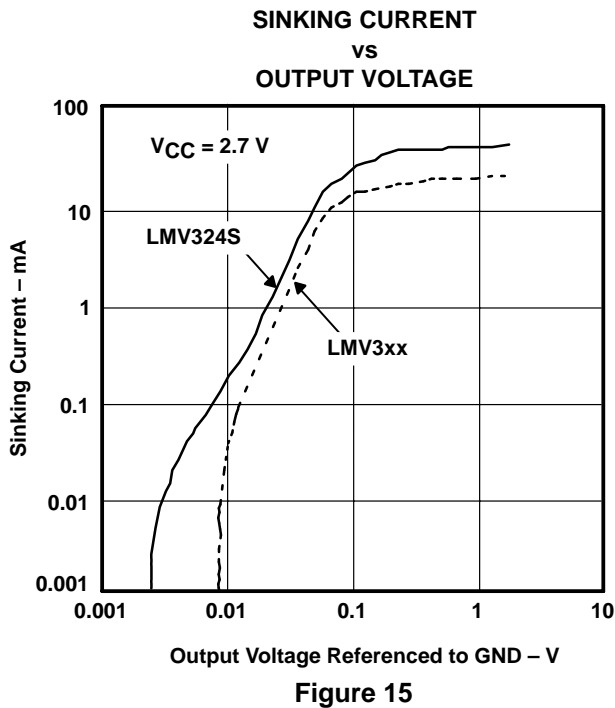
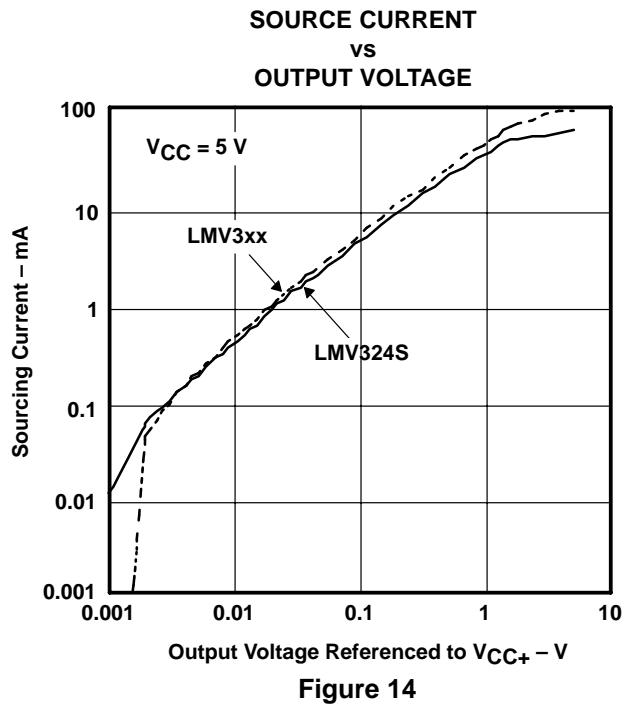
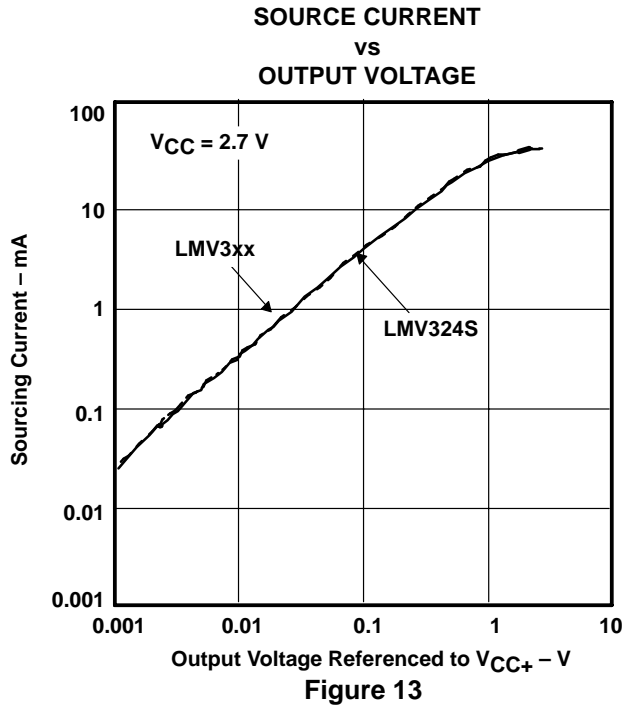

Figure 12

TYPICAL CHARACTERISTICS



LMV321 SINGLE, LMV358 DUAL, LMV324 QUAD, LMV324S QUAD WITH SHUTDOWN LOW-VOLTAGE RAIL-TO-RAIL OUTPUT OPERATIONAL AMPLIFIERS

SLOS263I – AUGUST 1999 – REVISED JANUARY 2003

TYPICAL CHARACTERISTICS

SHORT-CIRCUIT CURRENT
vs
TEMPERATURE

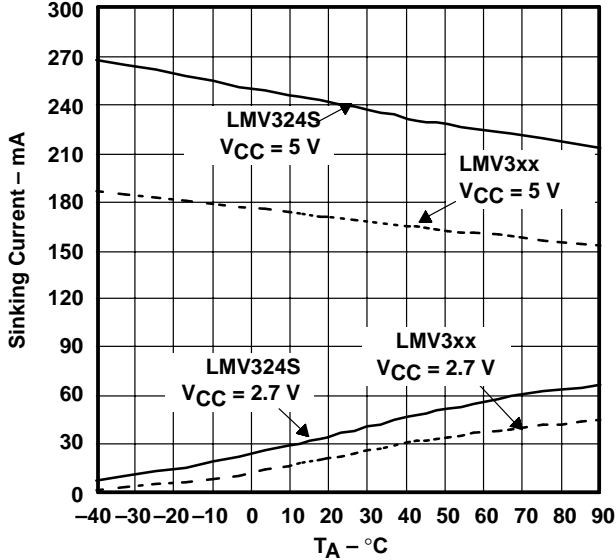

Figure 17

SHORT-CIRCUIT CURRENT
vs
TEMPERATURE

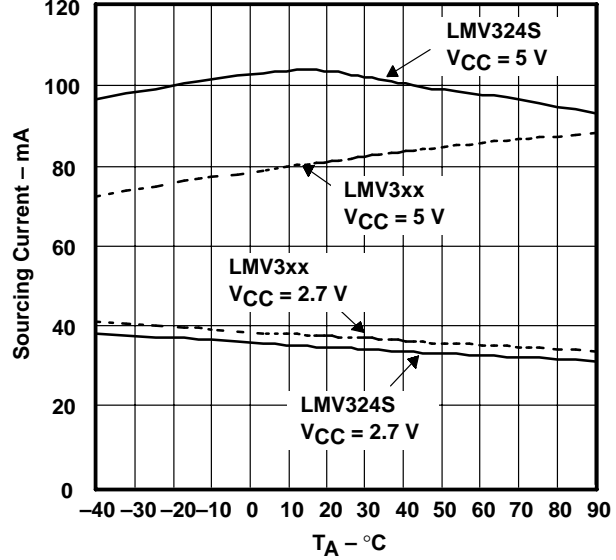

Figure 18

-k_{SVR}
vs
FREQUENCY

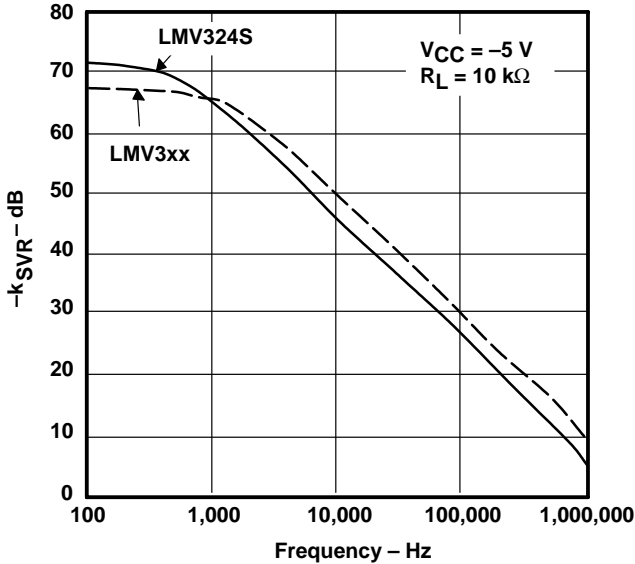

Figure 19

+k_{SVR}
vs
FREQUENCY

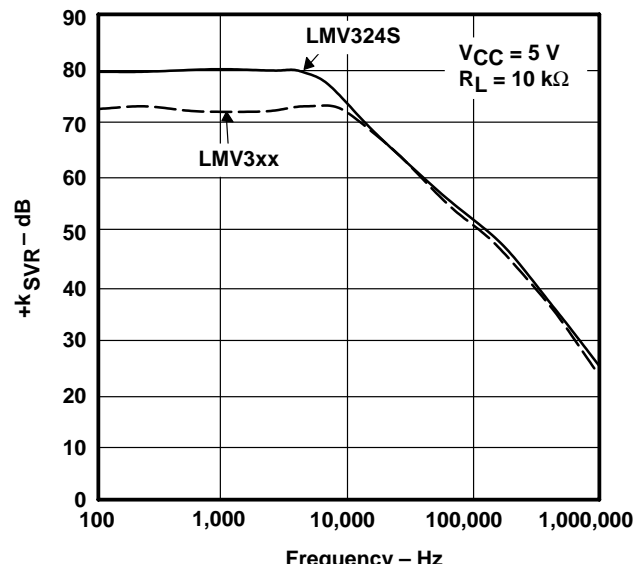
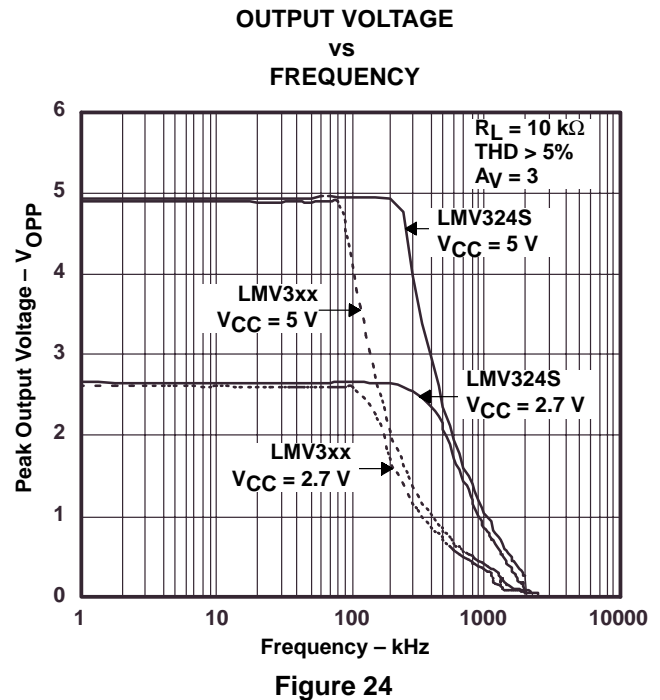
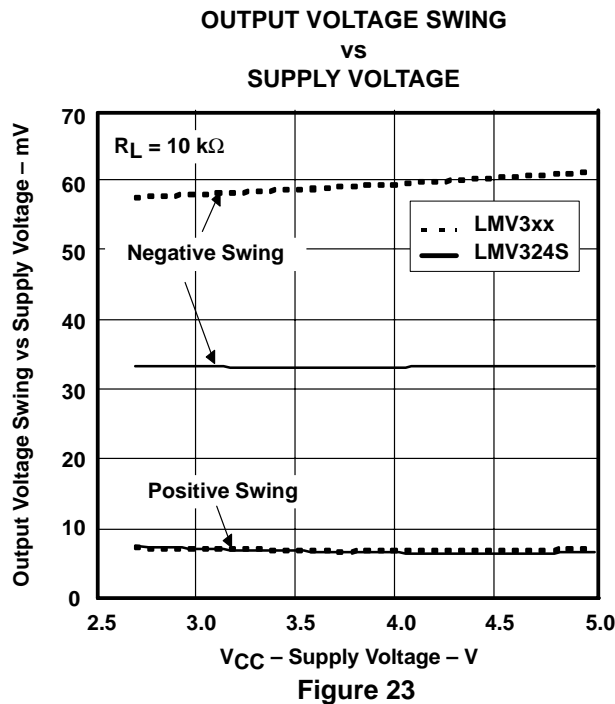
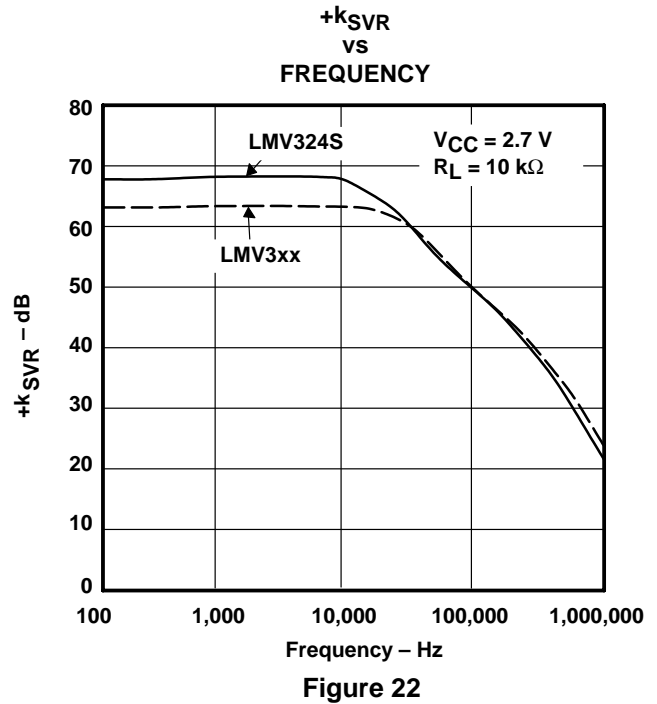
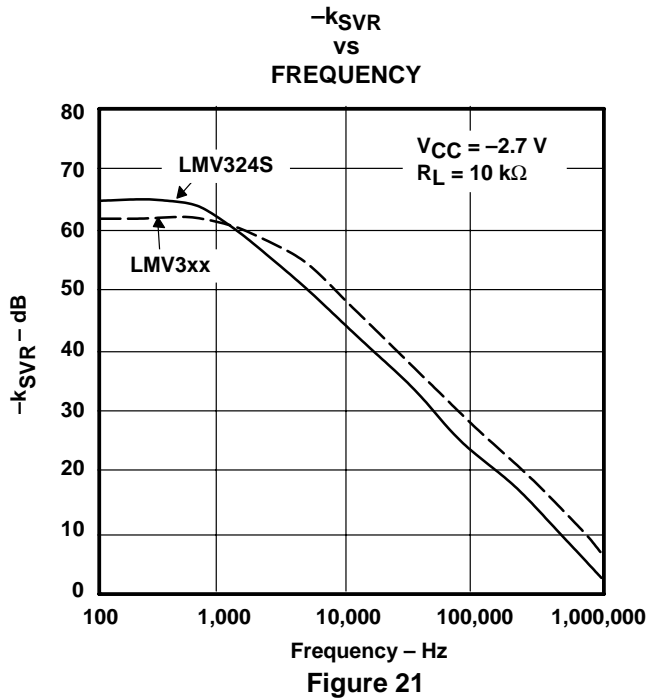

Figure 20

LMV321 SINGLE, LMV358 DUAL, LMV324 QUAD, LMV324S QUAD WITH SHUTDOWN LOW-VOLTAGE RAIL-TO-RAIL OUTPUT OPERATIONAL AMPLIFIERS

SLOS263I – AUGUST 1999 – REVISED JANUARY 2003

TYPICAL CHARACTERISTICS



LMV321 SINGLE, LMV358 DUAL, LMV324 QUAD, LMV324S QUAD WITH SHUTDOWN LOW-VOLTAGE RAIL-TO-RAIL OUTPUT OPERATIONAL AMPLIFIERS

SLOS263I – AUGUST 1999 – REVISED JANUARY 2003

TYPICAL CHARACTERISTICS

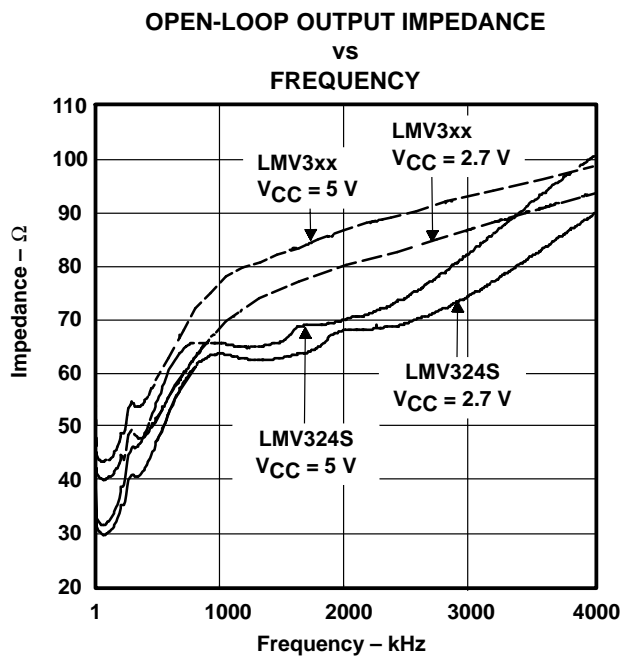

Figure 25

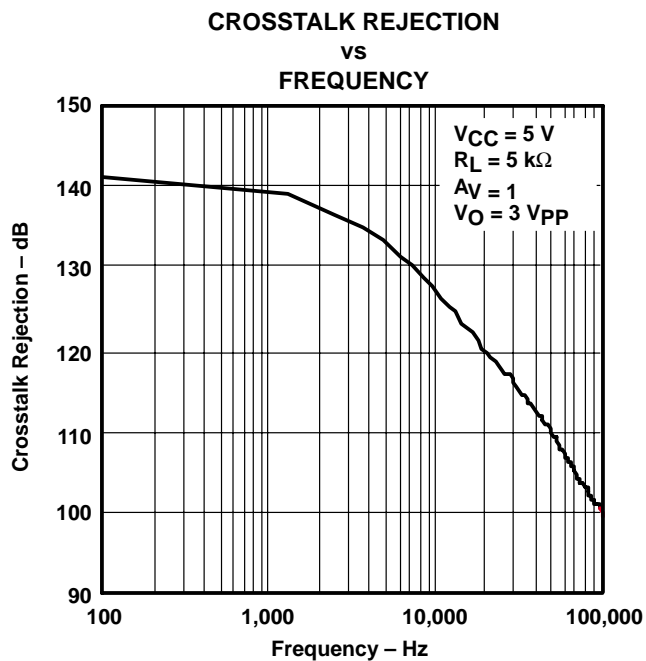

Figure 26



POST OFFICE BOX 655303 • DALLAS, TEXAS 75265

TYPICAL CHARACTERISTICS

NONINVERTING LARGE-SIGNAL
 PULSE RESPONSE

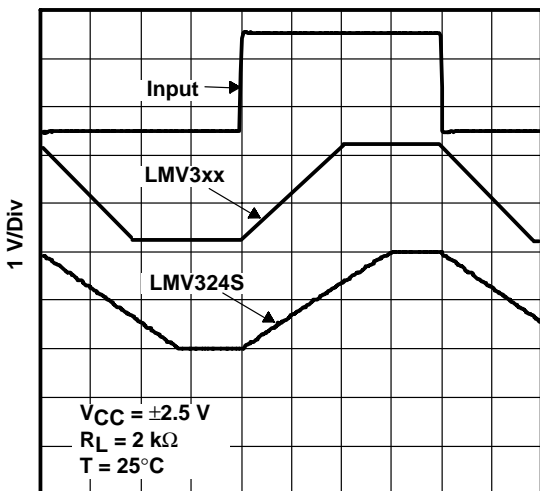

1 $\mu\text{s}/\text{Div}$
 Figure 27

NONINVERTING LARGE-SIGNAL
 PULSE RESPONSE

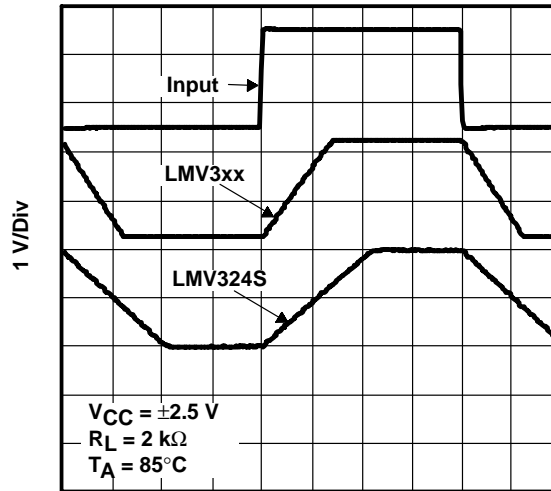

1 $\mu\text{s}/\text{Div}$
 Figure 28

NONINVERTING LARGE-SIGNAL
 PULSE RESPONSE

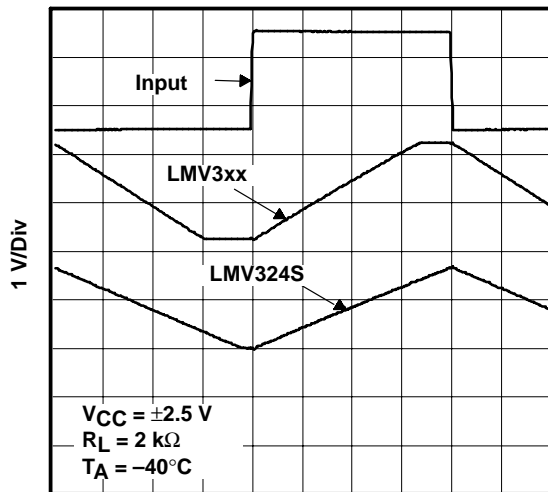

1 $\mu\text{s}/\text{Div}$
 Figure 29

LMV321 SINGLE, LMV358 DUAL, LMV324 QUAD, LMV324S QUAD WITH SHUTDOWN LOW-VOLTAGE RAIL-TO-RAIL OUTPUT OPERATIONAL AMPLIFIERS

SLOS263I – AUGUST 1999 – REVISED JANUARY 2003

TYPICAL CHARACTERISTICS

NONINVERTING SMALL-SIGNAL PULSE RESPONSE

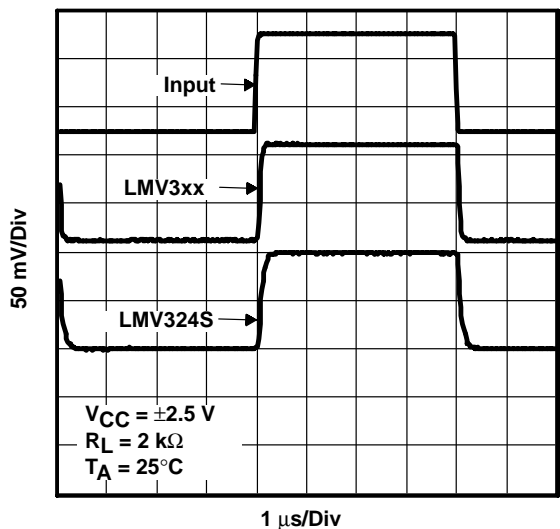

Figure 30

NONINVERTING SMALL-SIGNAL PULSE RESPONSE

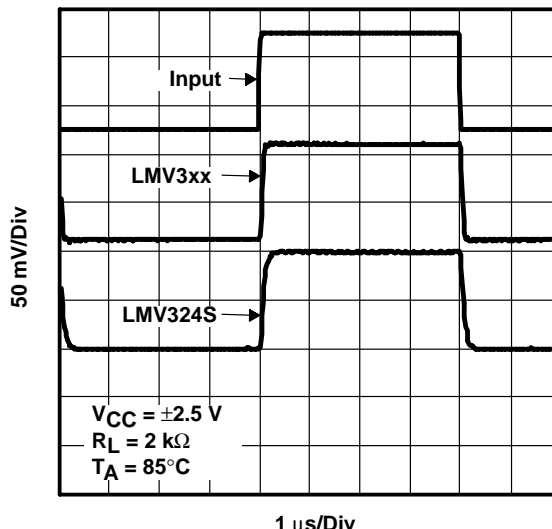

Figure 31

NONINVERTING SMALL-SIGNAL PULSE RESPONSE

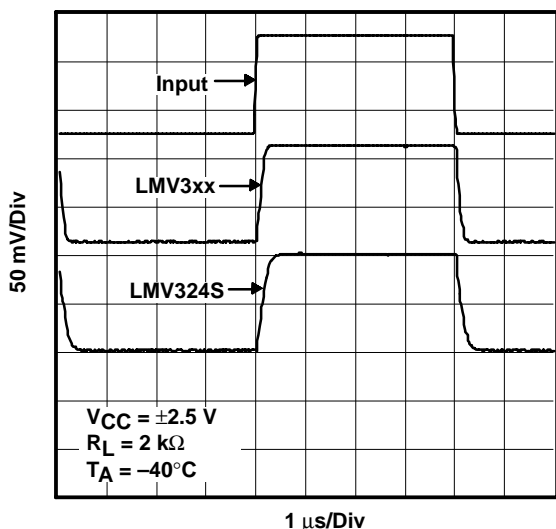

Figure 32

TYPICAL CHARACTERISTICS

INVERTING LARGE-SIGNAL
 PULSE RESPONSE

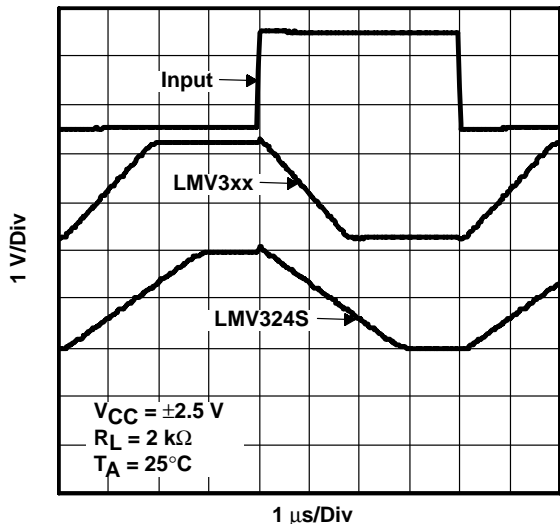

Figure 33

INVERTING LARGE-SIGNAL
 PULSE RESPONSE

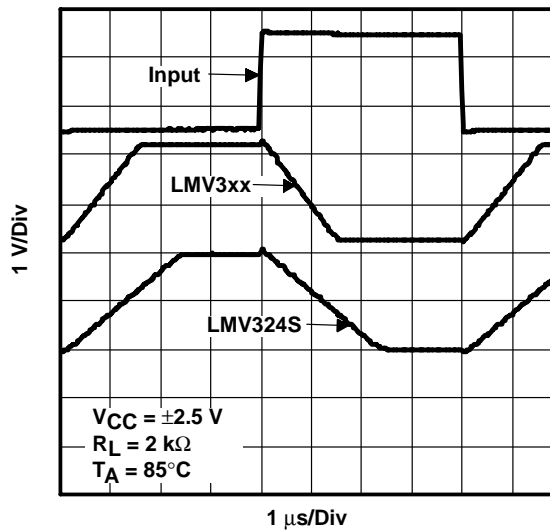

Figure 34

INVERTING LARGE-SIGNAL
 PULSE RESPONSE

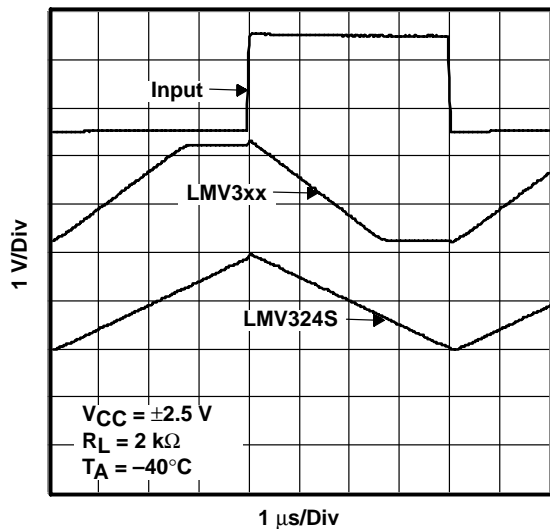

Figure 35

LMV321 SINGLE, LMV358 DUAL, LMV324 QUAD, LMV324S QUAD WITH SHUTDOWN LOW-VOLTAGE RAIL-TO-RAIL OUTPUT OPERATIONAL AMPLIFIERS

SLOS263I – AUGUST 1999 – REVISED JANUARY 2003

TYPICAL CHARACTERISTICS

INVERTING SMALL-SIGNAL PULSE RESPONSE

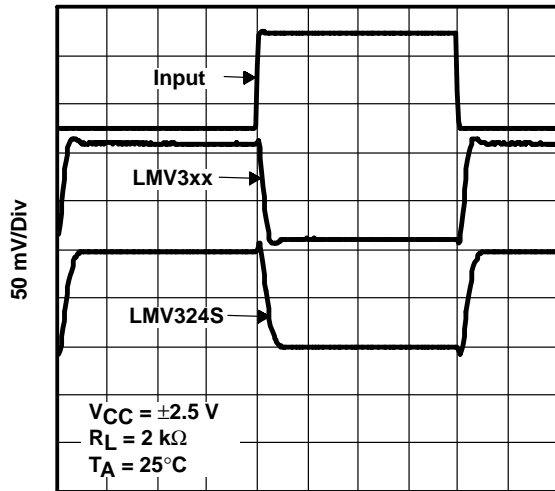

1 $\mu\text{s/Div}$
Figure 36

INVERTING SMALL-SIGNAL PULSE RESPONSE

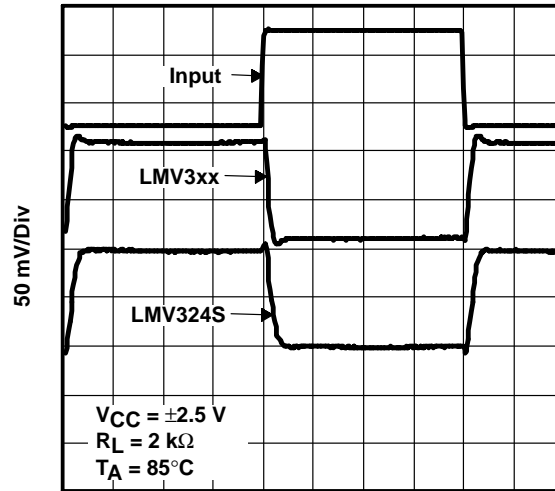

1 $\mu\text{s/Div}$
Figure 37

INVERTING SMALL-SIGNAL PULSE RESPONSE

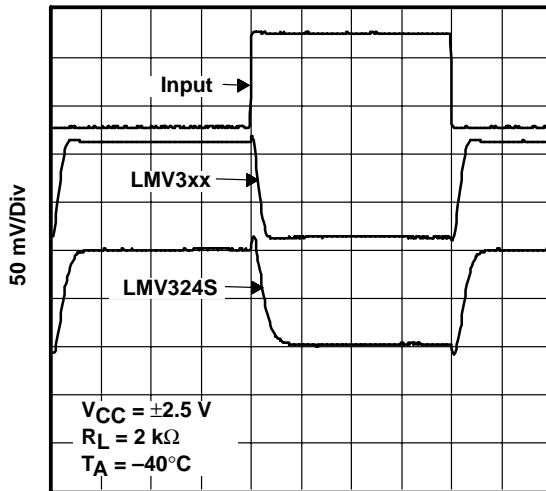

1 $\mu\text{s/Div}$
Figure 38

TYPICAL CHARACTERISTICS

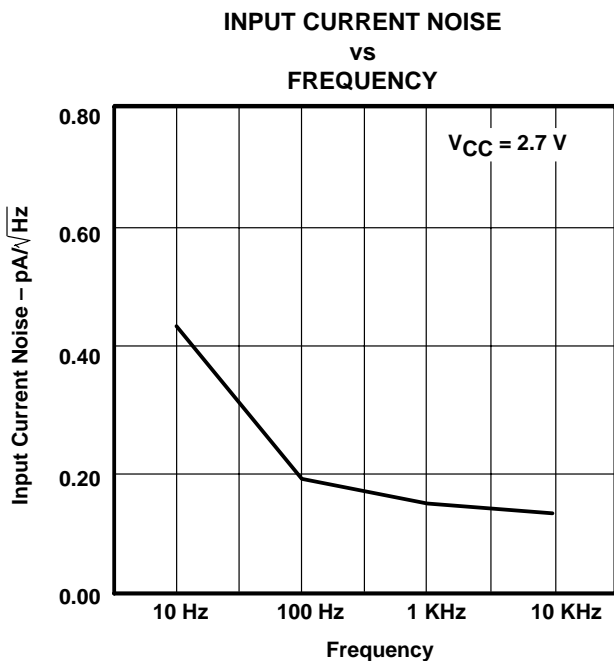

Figure 39

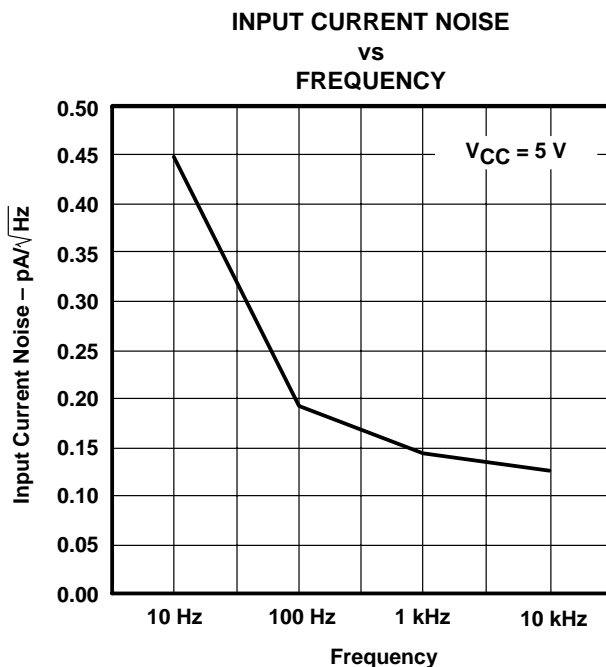

Figure 40

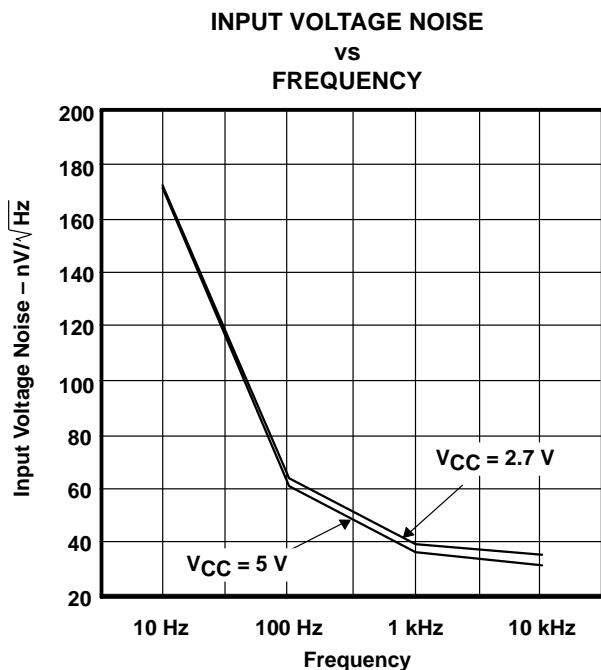

Figure 41

LMV321 SINGLE, LMV358 DUAL, LMV324 QUAD, LMV324S QUAD WITH SHUTDOWN LOW-VOLTAGE RAIL-TO-RAIL OUTPUT OPERATIONAL AMPLIFIERS

SLOS263I – AUGUST 1999 – REVISED JANUARY 2003

TYPICAL CHARACTERISTICS

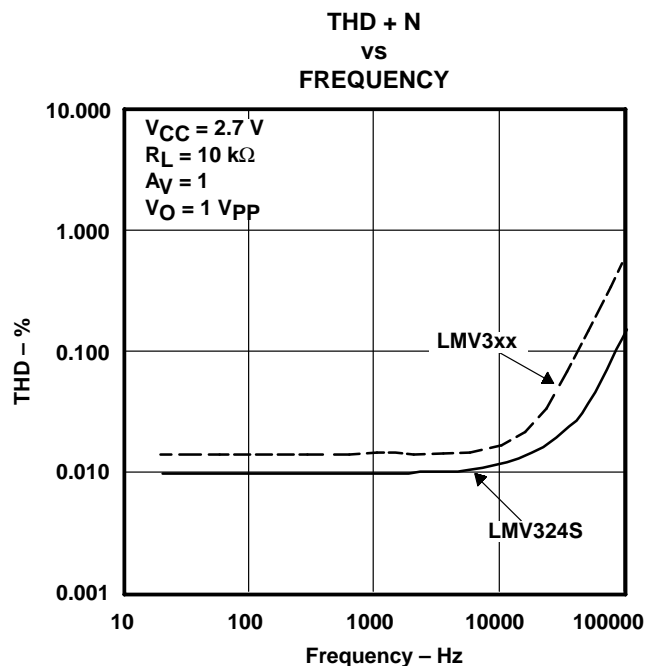

Figure 42

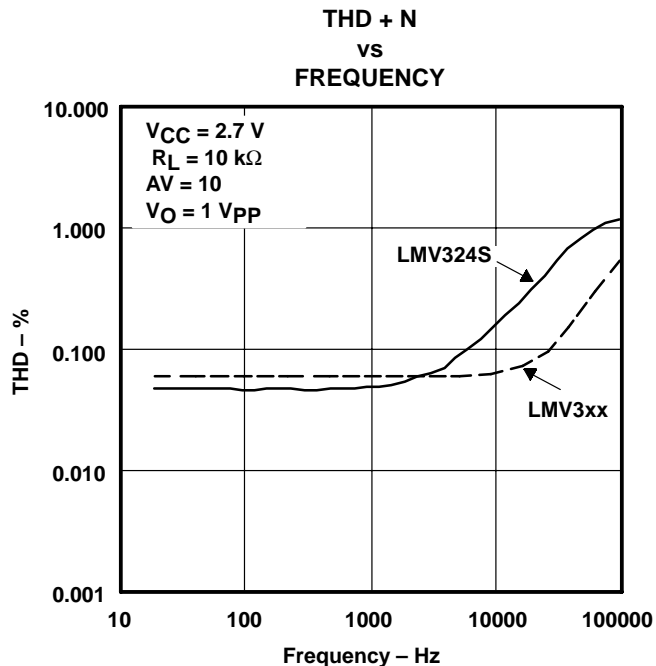

Figure 43

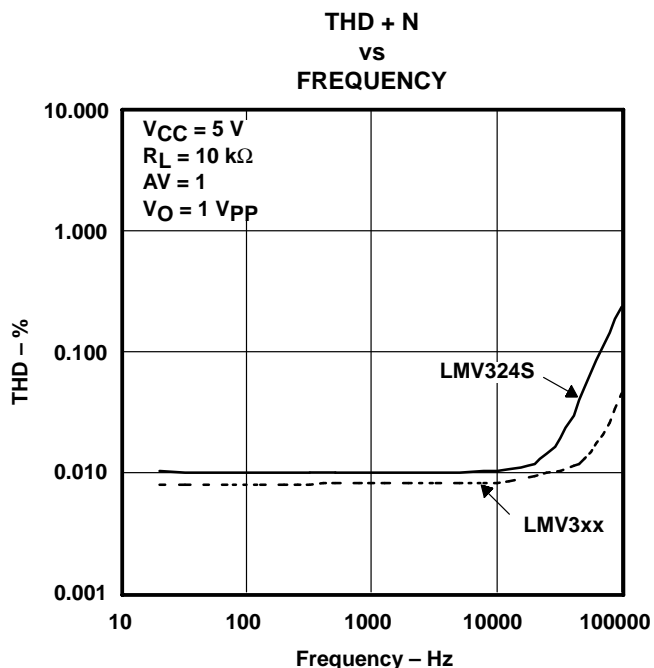

Figure 44

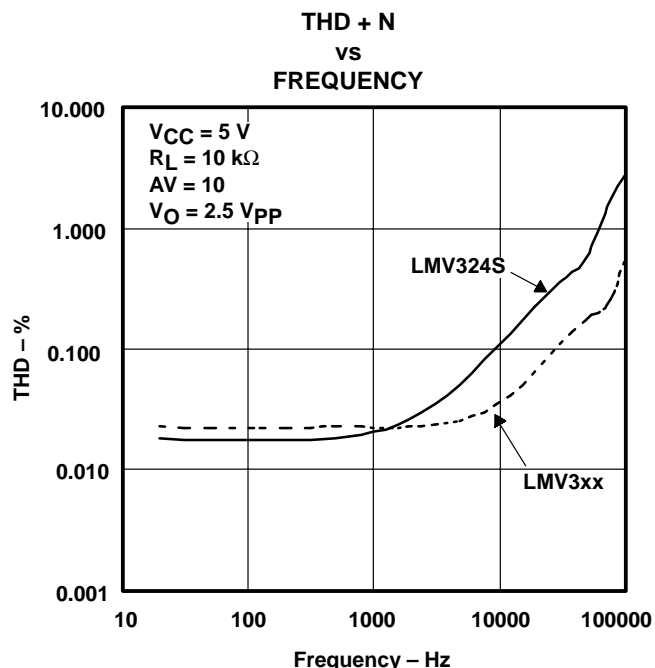
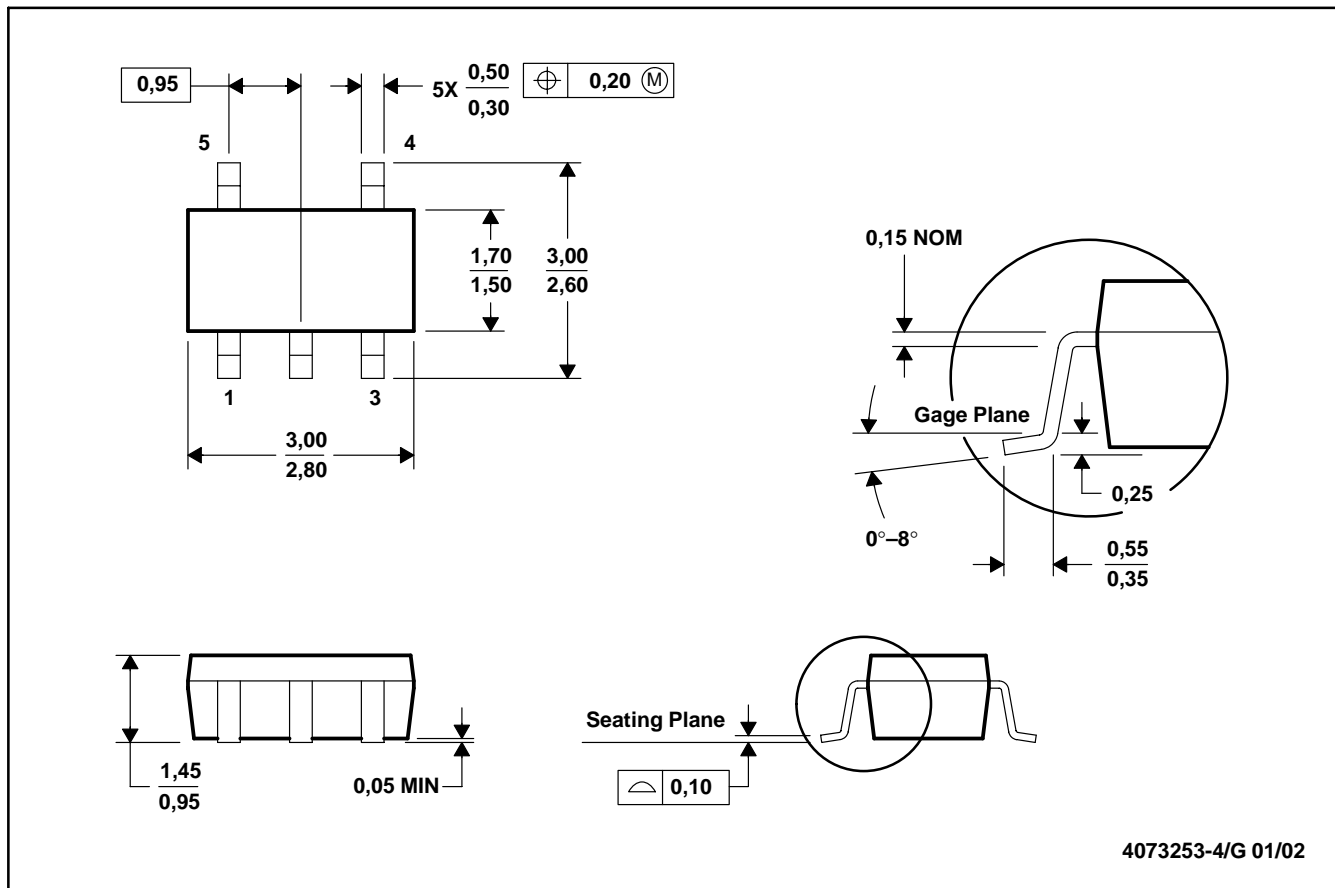

Figure 45



DBV (R-PDSO-G5)

PLASTIC SMALL-OUTLINE



- NOTES: A. All linear dimensions are in millimeters.
 B. This drawing is subject to change without notice.
 C. Body dimensions do not include mold flash or protrusion.
 D. Falls within JEDEC MO-178

DCK (R-PDSO-G5)

PLASTIC SMALL-OUTLINE PACKAGE

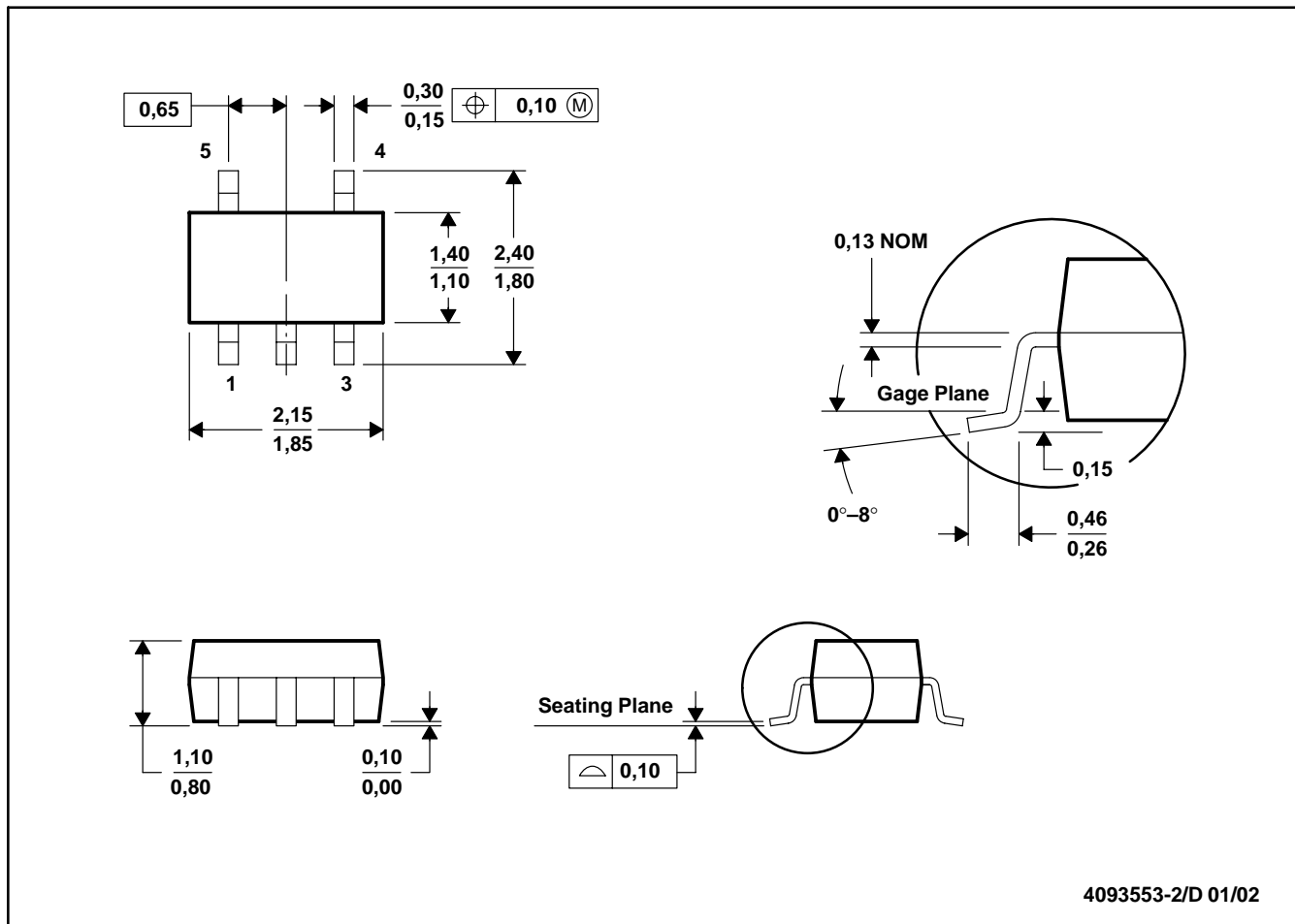

- NOTES: A. All linear dimensions are in millimeters.
 B. This drawing is subject to change without notice.
 C. Body dimensions do not include mold flash or protrusion.
 D. Falls within JEDEC MO-203

DGK (R-PDSO-G8)

PLASTIC SMALL-OUTLINE PACKAGE

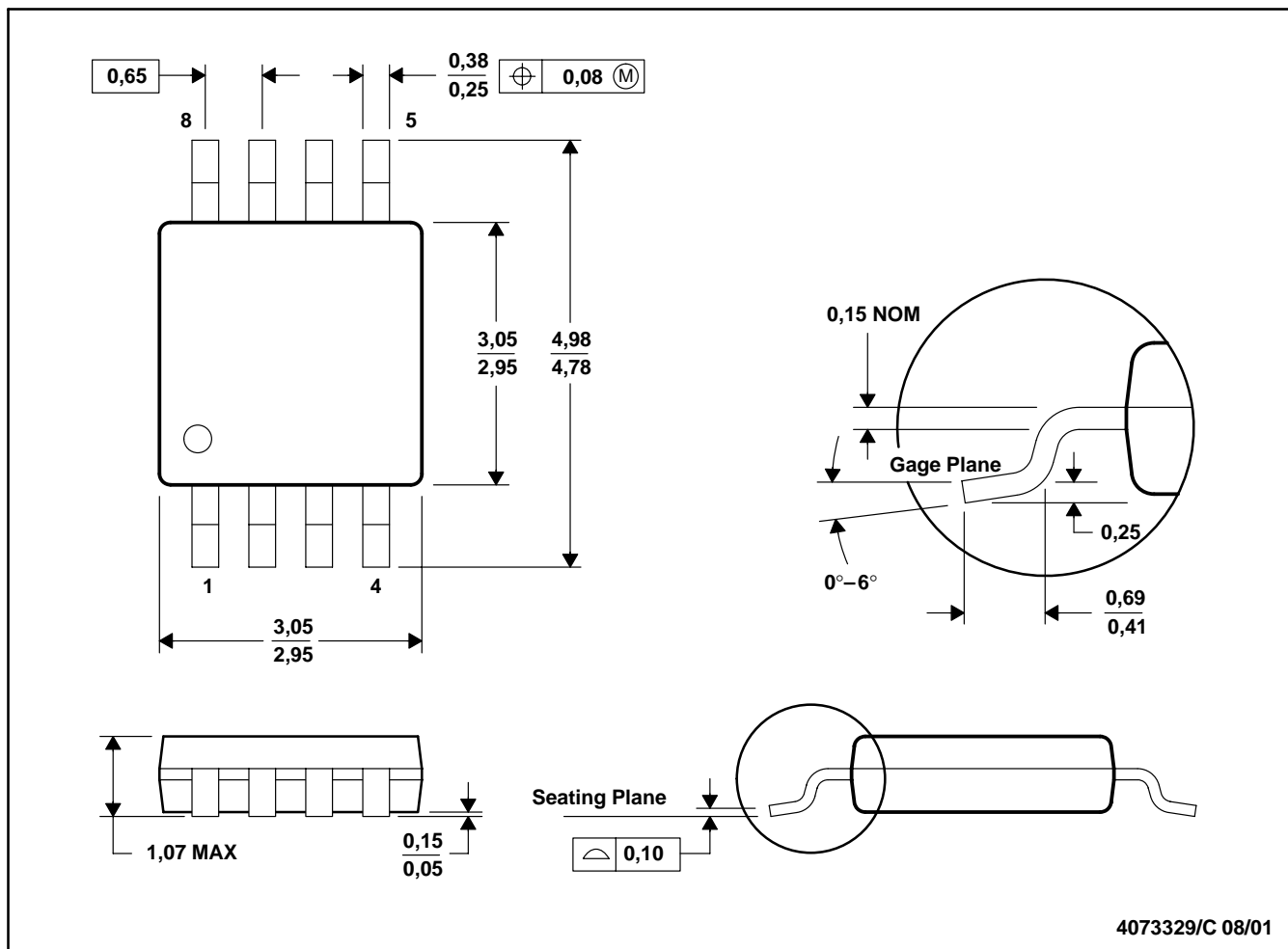

- NOTES: A. All linear dimensions are in millimeters.
 B. This drawing is subject to change without notice.
 C. Body dimensions do not include mold flash or protrusion.
 D. Falls within JEDEC MO-187

D (R-PDSO-G**)

PLASTIC SMALL-OUTLINE PACKAGE

8 PINS SHOWN

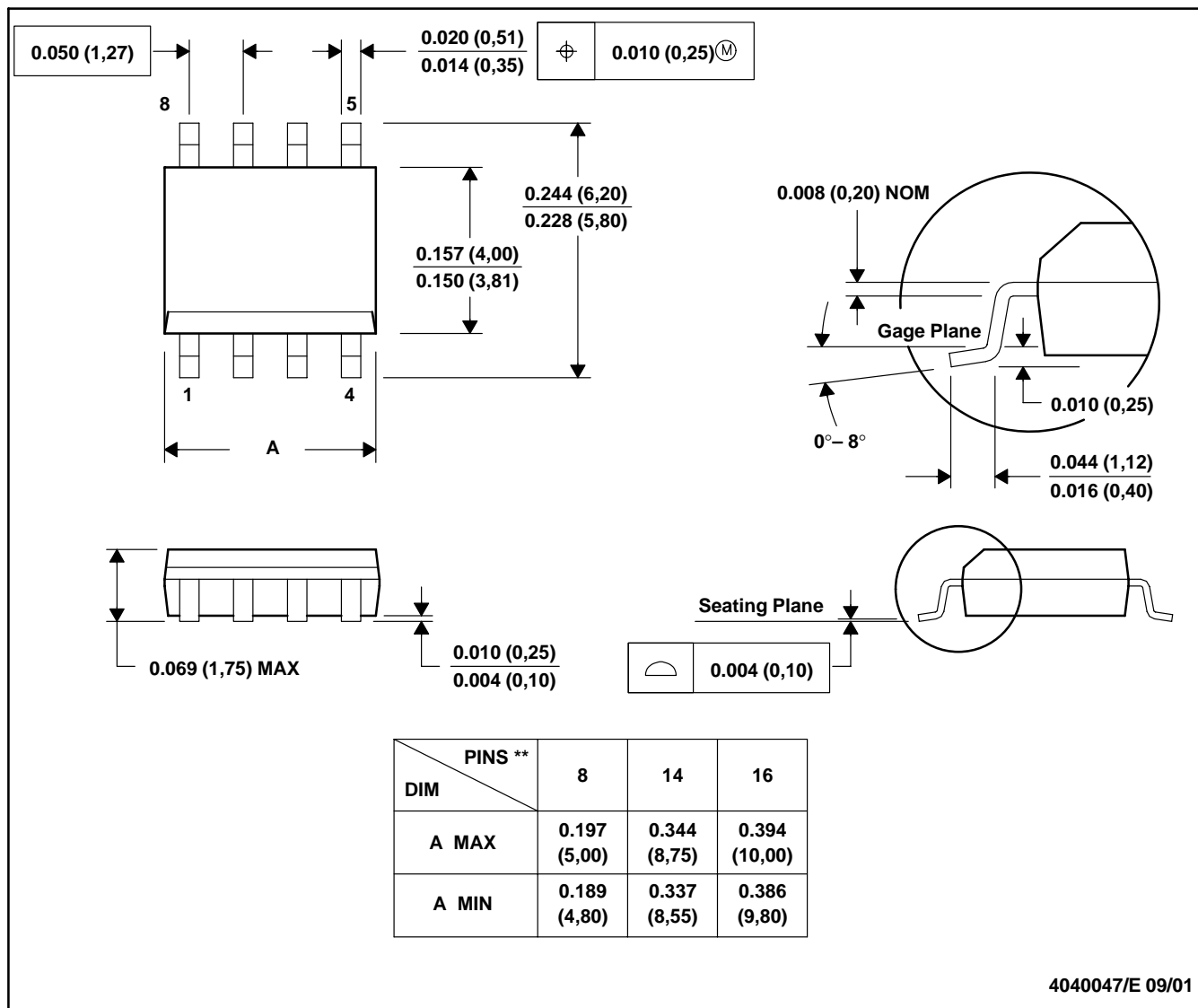

4040047/E 09/01

- NOTES: A. All linear dimensions are in inches (millimeters).
 B. This drawing is subject to change without notice.
 C. Body dimensions do not include mold flash or protrusion, not to exceed 0.006 (0,15).
 D. Falls within JEDEC MS-012

PW (R-PDSO-G**)

PLASTIC SMALL-OUTLINE PACKAGE

14 PINS SHOWN



4040064/F 01/97

- NOTES: A. All linear dimensions are in millimeters.
 B. This drawing is subject to change without notice.
 C. Body dimensions do not include mold flash or protrusion not to exceed 0,15.
 D. Falls within JEDEC MO-153

IMPORTANT NOTICE

Texas Instruments Incorporated and its subsidiaries (TI) reserve the right to make corrections, modifications, enhancements, improvements, and other changes to its products and services at any time and to discontinue any product or service without notice. Customers should obtain the latest relevant information before placing orders and should verify that such information is current and complete. All products are sold subject to TI's terms and conditions of sale supplied at the time of order acknowledgment.

TI warrants performance of its hardware products to the specifications applicable at the time of sale in accordance with TI's standard warranty. Testing and other quality control techniques are used to the extent TI deems necessary to support this warranty. Except where mandated by government requirements, testing of all parameters of each product is not necessarily performed.

TI assumes no liability for applications assistance or customer product design. Customers are responsible for their products and applications using TI components. To minimize the risks associated with customer products and applications, customers should provide adequate design and operating safeguards.

TI does not warrant or represent that any license, either express or implied, is granted under any TI patent right, copyright, mask work right, or other TI intellectual property right relating to any combination, machine, or process in which TI products or services are used. Information published by TI regarding third-party products or services does not constitute a license from TI to use such products or services or a warranty or endorsement thereof. Use of such information may require a license from a third party under the patents or other intellectual property of the third party, or a license from TI under the patents or other intellectual property of TI.

Reproduction of information in TI data books or data sheets is permissible only if reproduction is without alteration and is accompanied by all associated warranties, conditions, limitations, and notices. Reproduction of this information with alteration is an unfair and deceptive business practice. TI is not responsible or liable for such altered documentation.

Resale of TI products or services with statements different from or beyond the parameters stated by TI for that product or service voids all express and any implied warranties for the associated TI product or service and is an unfair and deceptive business practice. TI is not responsible or liable for any such statements.

Mailing Address:

Texas Instruments
Post Office Box 655303
Dallas, Texas 75265