

# LP2985 150-mA LOW-NOISE, LOW-DROPOUT REGULATOR WITH SHUTDOWN

SLVS522C – JULY 2004 – REVISED OCTOBER 2004

- Available in the Texas Instruments NanoStar™ and NanoFree™ Wafer Chip Scale Packages
- Output Tolerance of:
  - 1% (A Grade)
  - 1.5% (Standard Grade)
- Ultra-Low Dropout, Typically
  - 280 mV at Full Load of 150 mA
  - 7 mV at 1 mA
- Wide  $V_{IN}$  Range . . . 16 V Max
- Low  $I_Q$  . . . 850  $\mu$ A at Full Load at 150 mA
- Shutdown Current . . . 0.01  $\mu$ A Typ
- Low Noise . . . 30  $\mu$ V<sub>RMS</sub> With 10-nF Bypass Capacitor
- Stable With Low-ESR Capacitors, Including Ceramic
- Over-Current and Thermal Protection
- High Peak-Current Capability
- For  $V_{OUT}$  Options  $\leq 2.3$  V, See LP2985LV Data Sheet
- Portable Applications
  - Cellular Phones
  - Palmtop and Laptop Computers
  - Personal Digital Assistants (PDAs)
  - Digital Cameras and Camcorders
  - CD Players
  - MP3 Players

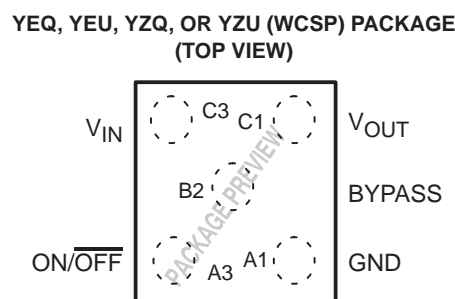
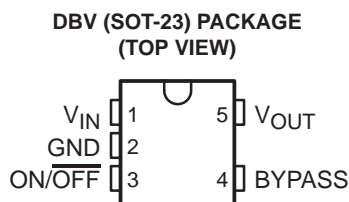

## description/ordering information

The LP2985 family of fixed-output, low-dropout regulators offers exceptional, cost-effective performance for both portable and nonportable applications. Available in voltages of 2.5 V, 2.6 V, 2.7 V, 2.8 V, 2.85 V, 3 V, 3.1 V, 3.2 V, 3.3 V, and 5 V, the family has an output tolerance of 1% for the A version (1.5% for the non-A version) and is capable of delivering 150-mA continuous load current. Standard regulator features, such as over-current and over-temperature protection, are included.

The LP2985 has a host of features that makes the regulator an ideal candidate for a variety of portable applications:

- Low dropout: A PNP pass element allows a typical dropout of 280 mV at 150-mA load current and 7 mV at 1-mA load.
- Low quiescent current: The use of a vertical PNP process allows for quiescent currents that are considerably lower than those associated with traditional lateral PNP regulators.
- Shutdown: A shutdown feature is available, allowing the regulator to consume only 0.01  $\mu$ A when the ON/OFF pin is pulled low.
- Low-ESR-capacitor friendly: The regulator is stable with low-ESR capacitors, allowing the use of small, inexpensive, ceramic capacitors in cost-sensitive applications.
- Low noise: A BYPASS pin allows for low-noise operation, with a typical output noise of 30  $\mu$ V (RMS), with the use of a 10-nF bypass capacitor.



Please be aware that an important notice concerning availability, standard warranty, and use in critical applications of Texas Instruments semiconductor products and disclaimers thereto appears at the end of this data sheet.

NanoStar and NanoFree are trademarks of Texas Instruments.

PRODUCTION DATA information is current as of publication date. Products conform to specifications per the terms of Texas Instruments standard warranty. Production processing does not necessarily include testing of all parameters.



POST OFFICE BOX 655303 • DALLAS, TEXAS 75265

Copyright © 2004, Texas Instruments Incorporated

# LP2985

## 150-mA LOW-NOISE, LOW-DROPOUT REGULATOR WITH SHUTDOWN

SLVS522C – JULY 2004 – REVISED OCTOBER 2004

### description/ordering information (continued)

- Small packaging: For the most space-constraint needs, the regulator is available in SOT-23 package, as well as NanoStar™ wafer chip scale packaging, offering an even smaller size with improved thermal and electrical characteristics. NanoStar package technology is a major breakthrough in IC packaging concepts, using the die as the package.

### ORDERING INFORMATION

T <sub>J</sub>	PART GRADE	V <sub>OUT</sub> (NOM)	PACKAGE†	ORDERABLE PART NUMBER	TOP-SIDE MARKING‡	
-40°C to 125°C	A grade: 1% tolerance	2.5 V	SOT23-5 (DBV)	Reel of 3000	LP2985A-25DBVR	PREVIEW
				Reel of 250	LP2985A-25DBVT	
		2.6 V		Reel of 3000	LP2985A-26DBVR	PREVIEW
				Reel of 250	LP2985A-26DBVT	
		2.7 V		Reel of 3000	LP2985A-27DBVR	PREVIEW
				Reel of 250	LP2985A-27DBVT	
		2.8 V		Reel of 3000	LP2985A-28DBVR	LPJ_
				Reel of 250	LP2985A-28DBVT	
		2.85 V		Reel of 3000	LP2985A-285DBVR	PREVIEW
				Reel of 250	LP2985A-285DBVT	
		3 V		Reel of 3000	LP2985A-30DBVR	PREVIEW
				Reel of 250	LP2985A-30DBVT	
		3.1 V		Reel of 3000	LP2985A-31DBVR	PREVIEW
				Reel of 250	LP2985A-31DBVT	
		3.2 V		Reel of 3000	LP2985A-32DBVR	PREVIEW
				Reel of 250	LP2985A-32DBVT	
		3.3 V		Reel of 3000	LP2985A-33DBVR	LPK_
				Reel of 250	LP2985A-33DBVT	
		5 V		Reel of 3000	LP2985A-50DBVR	PREVIEW
				Reel of 250	LP2985A-50DBVT	

† Package drawings, standard packing quantities, thermal data, symbolization, and PCB design guidelines are available at [www.ti.com/sc/package](http://www.ti.com/sc/package).

‡ DBV: The actual top-side marking has one additional character that designates the assembly/test site.



# LP2985

## 150-mA LOW-NOISE, LOW-DROPOUT REGULATOR WITH SHUTDOWN

SLVS522C – JULY 2004 – REVISED OCTOBER 2004

### ORDERING INFORMATION (continued)

T <sub>J</sub>	PART GRADE	V <sub>OUT</sub> (NOM)	PACKAGE†	ORDERABLE PART NUMBER	TOP-SIDE MARKING‡			
-40°C to 125°C	A grade: 1% tolerance	2.5 V	NanoStar™ – WCSP 0.17-mm Bump (YEQ)	Reel of 3000	LP2985A-25YEQR			
		2.6 V			LP2985A-26YEQR			
		2.7 V			LP2985A-27YEQR			
		2.8 V			LP2985A-28YEQR			
		2.85 V			LP2985A-285YEQR			
		3 V			LP2985A-30YEQR			
		3.1 V			LP2985A-31YEQR			
		3.2 V			LP2985A-32YEQR			
		3.3 V			LP2985A-33YEQR			
		5 V			LP2985A-50YEQR			
		2.5 V			NanoFree™ – WCSP 0.17-mm Bump (YZQ, Pb-free)	Reel of 3000	LP2985A-25YZQR	
		2.6 V					LP2985A-26YZQR	
		2.7 V	LP2985A-27YZQR					
		2.8 V	LP2985A-28YZQR					
		2.85 V	LP2985A-285YZQR					
		3 V	LP2985A-30YZQR					
		3.1 V	LP2985A-31YZQR					
		3.2 V	LP2985A-32YZQR					
		3.3 V	LP2985A-33YZQR					
		5 V	LP2985A-50YZQR					
		2.5 V	NanoFree™ – WCSP 0.30-mm Bump (YEU)	Reel of 3000			LP2985A-25YEUR	
		2.6 V					LP2985A-26YEUR	
		2.7 V			LP2985A-27YEUR			
		2.8 V			LP2985A-28YEUR			
		2.85 V			LP2985A-285YEUR			
		3 V			LP2985A-30YEUR			
		3.1 V			LP2985A-31YEUR			
		3.2 V			LP2985A-32YEUR			
		3.3 V			LP2985A-33YEUR			
		5 V			LP2985A-50YEUR			
		2.5 V			NanoFree™ – WCSP 0.30-mm Bump (YZU, Pb-free)	Reel of 3000	LP2985A-25YZUR	
		2.6 V					LP2985A-26YZUR	
		2.7 V	LP2985A-27YZUR					
		2.8 V	LP2985A-28YZUR					
		2.85 V	LP2985A-285YZUR					
		3 V	LP2985A-30YZUR					
3.1 V	LP2985A-31YZUR							
3.2 V	LP2985A-32YZUR							
3.3 V	LP2985A-33YZUR							
5 V	LP2985A-50YZUR							

† Package drawings, standard packing quantities, thermal data, symbolization, and PCB design guidelines are available at [www.ti.com/sc/package](http://www.ti.com/sc/package).

‡ YEQ/YZQ, YEU/YZU: The actual top-side marking has three preceding characters to denote year, month, and sequence code, and one following character to designate the assembly/test site. Pin 1 identifier indicates solder-bump composition (1 = SnPb, • = Pb-free).



**LP2985**  
**150-mA LOW-NOISE, LOW-DROPOUT REGULATOR**  
**WITH SHUTDOWN**

SLVS522C – JULY 2004 – REVISED OCTOBER 2004

**ORDERING INFORMATION (continued)**

T <sub>J</sub>	PART GRADE	V <sub>OUT</sub> (NOM)	PACKAGE†	ORDERABLE PART NUMBER	TOP-SIDE MARKING‡	
-40°C to 125°C	Standard grade: 1.5% tolerance	2.5 V	SOT-23 (DBV)	Reel of 3000	LP2985-25DBVR	PREVIEW
				Reel of 250	LP2985-25DBVT	
		2.6 V		Reel of 3000	LP2985-26DBVR	PREVIEW
				Reel of 250	LP2985-26DBVT	
		2.7 V		Reel of 3000	LP2985-27DBVR	PREVIEW
				Reel of 250	LP2985-27DBVT	
		2.8 V		Reel of 3000	LP2985-28DBVR	LPG_
				Reel of 250	LP2985-28DBVT	
		2.85 V		Reel of 3000	LP2985-285DBVR	PREVIEW
				Reel of 250	LP2985-285DBVT	
		3 V		Reel of 3000	LP2985-30DBVR	PREVIEW
				Reel of 250	LP2985-30DBVT	
		3.1 V		Reel of 3000	LP2985-31DBVR	PREVIEW
				Reel of 250	LP2985-31DBVT	
		3.2 V		Reel of 3000	LP2985-32DBVR	PREVIEW
				Reel of 250	LP2985-32DBVT	
		3.3 V		Reel of 3000	LP2985-33DBVR	LPF_
				Reel of 250	LP2985-33DBVT	
		5 V		Reel of 3000	LP2985-50DBVR	PREVIEW
				Reel of 250	LP2985-50DBVT	

† Package drawings, standard packing quantities, thermal data, symbolization, and PCB design guidelines are available at [www.ti.com/sc/package](http://www.ti.com/sc/package).

‡ DBV: The actual top-side marking has one additional character that designates the assembly/test site.



# LP2985

## 150-mA LOW-NOISE, LOW-DROPOUT REGULATOR WITH SHUTDOWN

SLVS522C – JULY 2004 – REVISED OCTOBER 2004

### ORDERING INFORMATION (continued)

T <sub>J</sub>	PART GRADE	V <sub>OUT</sub> (NOM)	PACKAGE†	ORDERABLE PART NUMBER	TOP-SIDE MARKING‡			
–40°C to 125°C	Standard grade: 1.5% tolerance	2.5 V	NanoStar™ – WCSP 0.17-mm Bump (YEQ)	Reel of 3000	LP2985-25YEQR			
		2.6 V			LP2985-26YEQR			
		2.7 V			LP2985-27YEQR			
		2.8 V			LP2985-28YEQR			
		2.85 V			LP2985-285YEQR			
		3 V			LP2985-30YEQR			
		3.1 V			LP2985-31YEQR			
		3.2 V			LP2985-32YEQR			
		3.3 V			LP2985-33YEQR			
		5 V			LP2985-50YEQR			
		2.5 V			NanoFree™ – WCSP 0.17-mm Bump (YZQ, Pb-free)	Reel of 3000	LP2985-25YZQR	
		2.6 V					LP2985-26YZQR	
		2.7 V	LP2985-27YZQR					
		2.8 V	LP2985-28YZQR					
		2.85 V	LP2985-285YZQR					
		3 V	LP2985-30YZQR					
		3.1 V	LP2985-31YZQR					
		3.2 V	LP2985-32YZQR					
		3.3 V	LP2985-33YZQR					
		5 V	LP2985-50YZQR					
		2.5 V	NanoStar™ – WCSP 0.30-mm Bump (YEU)	Reel of 3000			LP2985-25YEUR	
		2.6 V					LP2985-26YEUR	
		2.7 V			LP2985-27YEUR			
		2.8 V			LP2985-28YEUR			
		2.85 V			LP2985-285YEUR			
		3 V			LP2985-30YEUR			
		3.1 V			LP2985-31YEUR			
		3.2 V			LP2985-32YEUR			
		3.3 V			LP2985-33YEUR			
		5 V			LP2985-50YEUR			
		2.5 V			NanoFree™ – WCSP 0.30-mm Bump (YZU, Pb-free)	Reel of 3000	LP2985-25YZUR	
		2.6 V					LP2985-26YZUR	
		2.7 V	LP2985-27YZUR					
		2.8 V	LP2985-28YZUR					
		2.85 V	LP2985-285YZUR					
		3 V	LP2985-30YZUR					
3.1 V	LP2985-31YZUR							
3.2 V	LP2985-32YZUR							
3.3 V	LP2985-33YZUR							
5 V	LP2985-50YZUR							

† Package drawings, standard packing quantities, thermal data, symbolization, and PCB design guidelines are available at [www.ti.com/sc/package](http://www.ti.com/sc/package).

‡ YEQ/YZQ, YEU/YZU: The actual top-side marking has three preceding characters to denote year, month, and sequence code, and one following character to designate the assembly/test site. Pin 1 identifier indicates solder-bump composition (1 = SnPb, • = Pb-free).



# LP2985 150-mA LOW-NOISE, LOW-DROPOUT REGULATOR WITH SHUTDOWN

SLVS522C – JULY 2004 – REVISED OCTOBER 2004

## functional block diagram

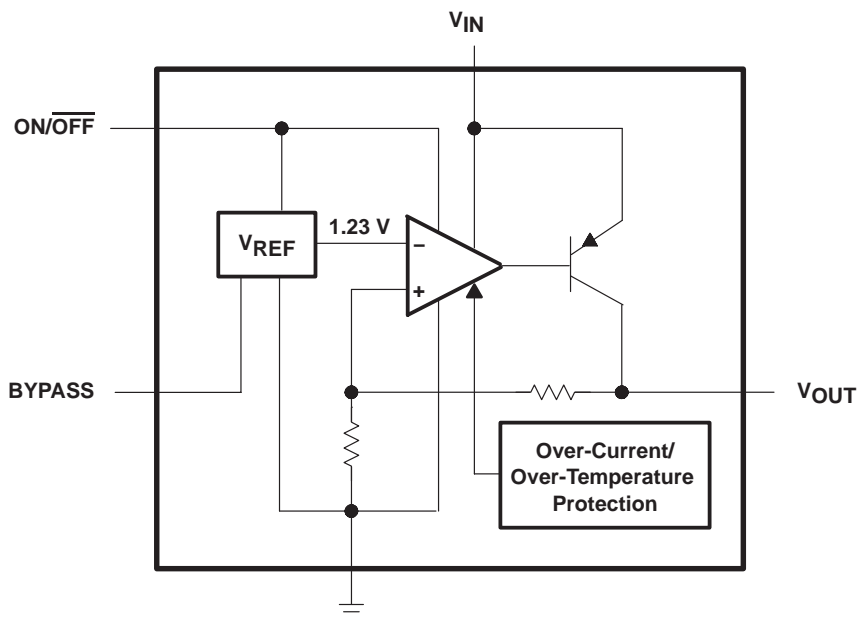

## basic application circuit

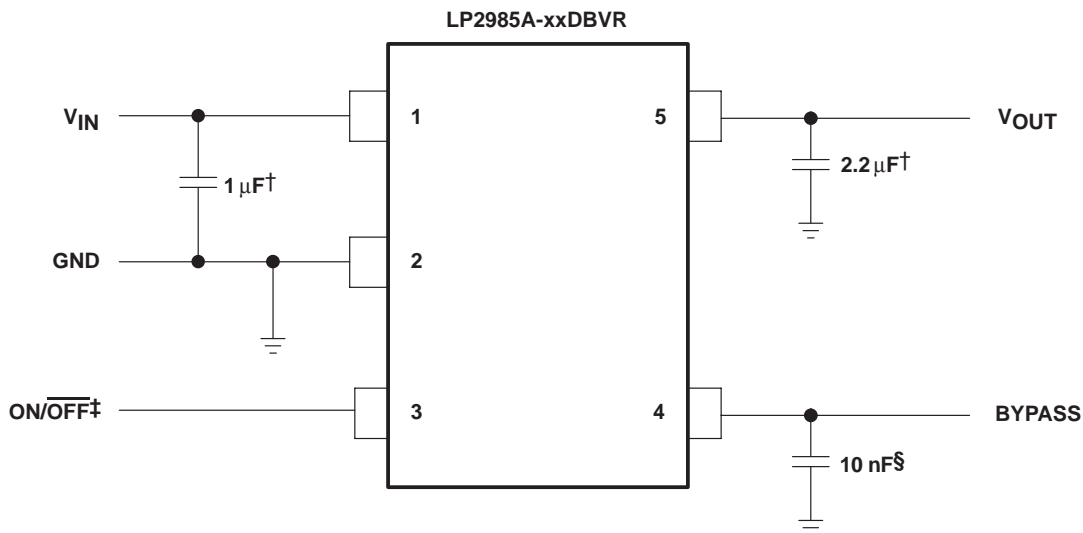

† Minimum  $C_{OUT}$  value for stability (can be increased without limit for improved stability and transient response)

‡  $ON/OFF$  must be actively terminated. Connect to  $V_{IN}$  if shutdown feature is not used.

§ Optional  $BYPASS$  capacitor for low-noise operation

# LP2985

## 150-mA LOW-NOISE, LOW-DROPOUT REGULATOR WITH SHUTDOWN

SLVS522C – JULY 2004 – REVISED OCTOBER 2004

### absolute maximum ratings over the virtual junction temperature range (unless otherwise noted)†

Continuous input voltage range, $V_{IN}$ .....	–0.3 V to 16 V
ON/ $\overline{OFF}$ input voltage range, $V_{ON/OFF}$ .....	–0.3 V to 16 V
Output voltage range (see Note 1) .....	–0.3 V to 9 V
Input/output voltage differential range, $V_{IN}-V_{OUT}$ (see Note 2) .....	–0.3 V to 16 V
Output current, $I_O$ (see Note 3) .....	Internally limited (short-circuit protected)
Package thermal impedance, $\theta_{JA}$ (see Notes 3 and 4): DBV package .....	206°C/W
YEQ/YZQ package .....	TBD°C/W
YEU/YZU package .....	TBD°C/W
Operating virtual junction temperature .....	150°C
Storage temperature range, $T_{stg}$ .....	–65°C to 150°C

† Stresses beyond those listed under “absolute maximum ratings” may cause permanent damage to the device. These are stress ratings only, and functional operation of the device at these or any other conditions beyond those indicated under “recommended operating conditions” is not implied. Exposure to absolute-maximum-rated conditions for extended periods may affect device reliability.

- NOTES:
1. If load is returned to a negative power supply in a dual-supply system, the output must be diode clamped to GND.
  2. The PNP pass transistor has a *parasitic* diode connected between the input and output. This diode normally is reverse biased ( $V_{IN} > V_{OUT}$ ), but will be forward biased if the output voltage exceeds the input voltage by a diode drop (see Application Information for more details).
  3. Maximum power dissipation is a function of  $T_J(max)$ ,  $\theta_{JA}$ , and  $T_A$ . The maximum allowable power dissipation at any allowable ambient temperature is  $P_D = (T_J(max) - T_A)/\theta_{JA}$ . Operating at the absolute maximum  $T_J$  of 150°C can affect reliability.
  4. The package thermal impedance is calculated in accordance with JESD 51-7.

### recommended operating conditions

		MIN	MAX	UNIT
$V_{IN}$	Supply input voltage	‡	16	V
$V_{ON/OFF}$	ON/ $\overline{OFF}$ input voltage	0	$V_{IN}$	V
$I_{OUT}$	Output current		150	mA
$T_J$	Virtual junction temperature	–40	125	°C

- ‡ Recommended minimum  $V_{IN}$  is the greater of:
- a) 2.5 V or
  - b)  $V_{OUT(max)}$  + rated dropout voltage (max) for operating  $I_L$ .



# LP2985 150-mA LOW-NOISE, LOW-DROPOUT REGULATOR WITH SHUTDOWN

SLVS522C – JULY 2004 – REVISED OCTOBER 2004

electrical characteristics at specified virtual junction temperature range,  
 $V_{IN} = V_{OUT}(\text{nominal}) + 1\text{ V}$ ,  $V_{ON/OFF} = 2\text{ V}$ ,  $C_{IN} = 1\ \mu\text{F}$ ,  $I_L = 1\text{ mA}$ ,  $C_{OUT} = 4.7\ \mu\text{F}$  (unless otherwise noted)

PARAMETER	TEST CONDITIONS	T <sub>J</sub>	LP2985A-XX			LP2985-XX			UNIT
			MIN	TYP	MAX	MIN	TYP	MAX	
$\Delta V_{OUT}$	Output voltage tolerance	$I_L = 1\text{ mA}$	25°C	-1	1	-1.5	1.5	%V <sub>NOM</sub>	
		$1\text{ mA} \leq I_L \leq 50\text{ mA}$	25°C	-1.5	1.5	-2.5	2.5		
	$1\text{ mA} \leq I_L \leq 150\text{ mA}$	25°C	-2.5	2.5	-3.5	3.5			
		-40°C to 125°C	-3.5	3.5	-4.0	4.0			
Line regulation	$V_{IN} = [V_{OUT}(\text{NOM}) + 1\text{ V}]$ to 16V	25°C	0.007	0.014	0.007	0.014	%V		
		-40°C to 125°C	0.032	0.032	0.032	0.032			
$V_{IN} - V_{OUT}$	Dropout voltage (see Note 5)	$I_L = 0$	25°C	1	3	1	3	mV	
			-40°C to 125°C	5	5	5	5		
		$I_L = 1\text{ mA}$	25°C	7	10	7	10		
			-40°C to 125°C	15	15	15	15		
		$I_L = 10\text{ mA}$	25°C	40	60	40	60		
			-40°C to 125°C	90	90	90	90		
		$I_L = 50\text{ mA}$	25°C	120	150	120	150		
			-40°C to 125°C	225	225	225	225		
		$I_L = 150\text{ mA}$	25°C	280	350	280	350		
			-40°C to 125°C	575	575	575	575		
$I_{GND}$	Ground pin current	$I_L = 0$	25°C	65	95	65	95	$\mu\text{A}$	
			-40°C to 125°C	125	125	125	125		
		$I_L = 1\text{ mA}$	25°C	75	110	75	110		
			-40°C to 125°C	170	170	170	170		
		$I_L = 10\text{ mA}$	25°C	120	220	120	220		
			-40°C to 125°C	400	400	400	400		
		$I_L = 50\text{ mA}$	25°C	350	600	350	600		
			-40°C to 125°C	1000	1000	1000	1000		
		$I_L = 150\text{ mA}$	25°C	850	1500	850	1500		
			-40°C to 125°C	2500	2500	2500	2500		
$V_{ON/OFF}$	ON/OFF input voltage (see Note 6)	$V_{ON/OFF} = \text{HIGH} \rightarrow \text{O/P ON}$	25°C	1.4	1.4	1.4	V		
			-40°C to 125°C	1.6	1.6	1.6			
		$V_{ON/OFF} = \text{LOW} \rightarrow \text{O/P OFF}$	25°C	0.55	0.55	0.55			
			-40°C to 125°C	0.15	0.15	0.15			
$I_{ON/OFF}$	ON/OFF input current	$V_{ON/OFF} = 0$	25°C	0.01	0.01	0.01	$\mu\text{A}$		
			-40°C to 125°C	-2	-2	-2			
		$V_{ON/OFF} = 5\text{ V}$	25°C	5	5	5			
			-40°C to 125°C	15	15	15			

NOTES: 5. Dropout voltage is defined as the input-to-output differential at which the output voltage drops 100 mV below the value measured with a 1-V differential.  
 6. The ON/OFF input must be properly driven for reliable operation (see Application Information).





**LP2985**  
**150-mA LOW-NOISE, LOW-DROPOUT REGULATOR**  
**WITH SHUTDOWN**

SLVS522C – JULY 2004 – REVISED OCTOBER 2004

electrical characteristics at specified virtual junction temperature range,  
 $V_{IN} = V_{OUT}(\text{nominal}) + 1\text{ V}$ ,  $V_{ON/OFF} = 2\text{ V}$ ,  $C_{IN} = 1\text{ }\mu\text{F}$ ,  $I_L = 1\text{ mA}$ ,  $C_{OUT} = 4.7\text{ }\mu\text{F}$  (unless otherwise noted)  
 (continued)

PARAMETER	TEST CONDITIONS	$T_J$	LP2985A-XX			LP2985-XX			UNIT
			MIN	TYP	MAX	MIN	TYP	MAX	
$V_n$ Output noise (RMS)	BW = 300 Hz to 50 kHz, $C_{OUT} = 10\text{ }\mu\text{F}$ , $C_{BYPASS} = 10\text{ nF}$	25°C		30			30		$\mu\text{V}$
$\Delta V_{OUT}/\Delta V_{IN}$ Ripple rejection	f = 1kHz, $C_{OUT} = 10\text{ }\mu\text{F}$ , $C_{BYPASS} = 10\text{ nF}$	25°C		45			45		dB
$I_{OUT(PK)}$ Peak output current	$V_{OUT} \geq V_{O(NOM)} - 5\%$	25°C		350			350		mA
$I_{OUT(SC)}$ Short-circuit current	$R_L = 0$ (steady state) (see Note 7)	25°C		400			400		mA

NOTE 7: See Typical Characteristics Curve, Short-Circuit Current vs  $V_{OUT}$

# LP2985 150-mA LOW-NOISE, LOW-DROPOUT REGULATOR WITH SHUTDOWN

SLVS522C – JULY 2004 – REVISED OCTOBER 2004

## APPLICATION INFORMATION

### capacitors

#### input capacitor ( $C_{in}$ )

A minimum value of 1  $\mu\text{F}$  (over the entire operating temperature range) is required at the input of the LP2985. In addition, this input capacitor should be located within 1 cm of the input pin and connected to a clean analog ground. There are no Equivalent Series Resistance (ESR) requirements for this capacitor, and the capacitance can be increased without limit.

#### output capacitor ( $C_{out}$ )

As an advantage over other regulators, the LP2985 permits the use of low-ESR capacitors at the output, including ceramic capacitors that can have an ESR as low as 5 m $\Omega$ . Tantalum and film capacitors also can be used if size and cost are not issues. The output capacitor also should be located within 1 cm of the output pin and be returned to a clean analog ground.

As with other PNP LDOs, stability conditions require the output capacitor to have a minimum capacitance and an ESR that falls within a certain range.

Minimum  $C_{out}$ : 2.2  $\mu\text{F}$  (can be increased without limit to improve transient response stability margin)

ESR range: see Figure 1

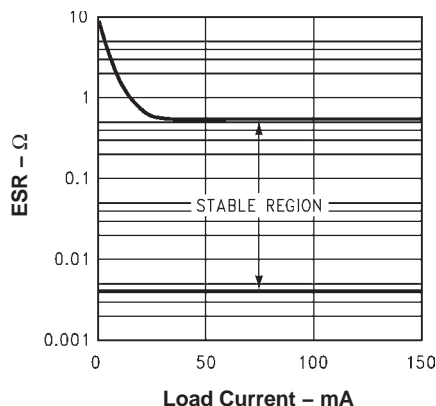

Figure 1. 2.2-V/3.3- $\mu\text{F}$  ESR Curves

It is critical that both the minimum capacitance and ESR requirement be met *over the entire operating temperature range*. Depending on the type of capacitors used, both these parameters can vary significantly with temperature (see capacitor characteristics section).

#### noise bypass capacitor ( $C_{bypass}$ )

The LP2985 allows for low-noise performance with the use of a bypass capacitor that is connected to the internal bandgap reference via the BYPASS pin. This high-impedance bandgap circuitry is biased in the microampere range and, thus, cannot be loaded significantly, otherwise, its output – and, correspondingly, the output of the regulator – will change. Thus, for best output accuracy, dc leakage current through  $C_{bypass}$  should be minimized as much as possible and never should exceed 100 nA.

A 10-nF capacitor is recommended for  $C_{bypass}$ ; ceramic and film capacitors are well suited for this purpose.

---

## APPLICATION INFORMATION

### capacitor characteristics

#### ceramics

Ceramic capacitors are ideal choices for use on the output of the LP2985 for several reasons. For capacitances in the range of 2.2  $\mu\text{F}$  to 4.7  $\mu\text{F}$ , ceramic capacitors have the lowest cost and the lowest ESR, making them choice candidates for filtering high-frequency noise. For instance, a typical 2.2- $\mu\text{F}$  ceramic capacitor has an ESR in the range of 10 m $\Omega$  to 20 m $\Omega$  and, thus, satisfies minimum ESR requirements of the regulator.

Ceramic capacitors have one glaring disadvantage that must be taken into account – a poor temperature coefficient, where the capacitance can vary significantly with temperature. For instance, a large-value ceramic capacitor ( $\geq 2.2 \mu\text{F}$ ) can lose more than half of its capacitance as the temperature rises from 25°C to 85°C. Thus, a 2.2- $\mu\text{F}$  capacitor at 25°C will drop well below the minimum  $C_{\text{out}}$  required for stability, as ambient temperature rises. For this reason, select an output capacitor that maintains the minimum 2.2  $\mu\text{F}$  required for stability over the *entire operating temperature range*. Note that there are some ceramic capacitors that can maintain a  $\pm 15\%$  capacitance tolerance over temperature.

#### tantalum

Tantalum capacitors can be used at the output of the LP2985, but there are significant disadvantages that could prohibit their use:

- In the 1- $\mu\text{F}$  to 4.7- $\mu\text{F}$  range, tantalum capacitors are more expensive than ceramics of the equivalent capacitance and voltage ratings.
- Tantalum capacitors have higher ESRs than their equivalent-sized ceramic counterparts. Thus, to meet the ESR requirements, a higher-capacitance tantalum may be required, at the expense of larger size and higher cost.
- The ESR of a tantalum capacitor increases as temperature drops, as much as double from 25°C to -40°C. Thus, ESR margins must be maintained over the temperature range in order to prevent regulator instability.

### ON/OFF operation

The LP2985 allows for a shutdown mode via the ON/ $\overline{\text{OFF}}$  pin. Driving the pin LOW ( $\leq 0.3 \text{ V}$ ) turns the device OFF; conversely, a HIGH ( $\geq 1.6 \text{ V}$ ) turns the device ON. If the shutdown feature is not used, ON/ $\overline{\text{OFF}}$  should be connected to the input to ensure that the regulator is on at all times. For proper operation, do not leave ON/ $\overline{\text{OFF}}$  unconnected, and apply a signal with a slew rate of  $\geq 40 \text{ mV}/\mu\text{s}$ .

# LP2985 150-mA LOW-NOISE, LOW-DROPOUT REGULATOR WITH SHUTDOWN

SLVS522C – JULY 2004 – REVISED OCTOBER 2004

## APPLICATION INFORMATION

### reverse input-output voltage

There is an inherent diode present across the PNP pass element of the LP2985.

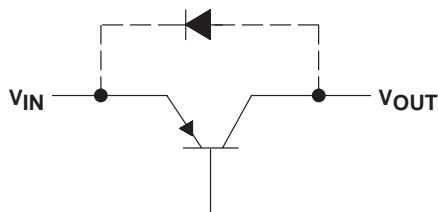

With the anode connected to the output, this diode is reverse biased during normal operation, since the input voltage is higher than the output. However, if the output is pulled higher than the input for any reason, this diode is forward biased and can cause a parasitic silicon-controlled rectifier (SCR) to latch, resulting in high current flowing from the output to the input. Thus, to prevent possible damage to the regulator in any application where the output may be pulled above the input, an external Schottky diode should be connected between the output and input. With the anode on output, this Schottky limits the reverse voltage across the output and input pins to  $\sim 0.3$  V, preventing the regulator's internal diode from forward biasing.

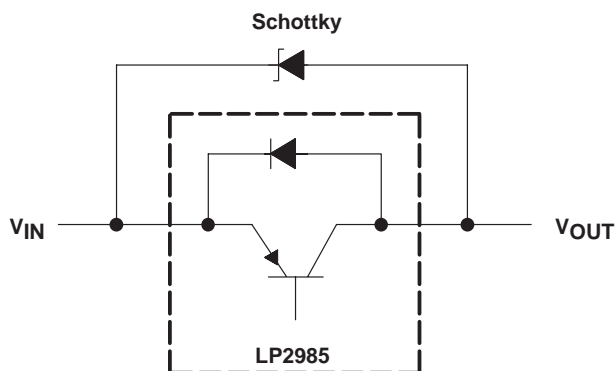

# LP2985 150-mA LOW-NOISE, LOW-DROPOUT REGULATOR WITH SHUTDOWN

SLVS522C – JULY 2004 – REVISED OCTOBER 2004

**TYPICAL PERFORMANCE CHARACTERISTICS**  
 $C_{IN} = 1 \mu\text{F}$ ,  $C_{OUT} = 4.7 \mu\text{F}$ ,  $V_{IN} = V_{OUT(NOM)} + 1 \text{ V}$ ,  $T_A = 25^\circ\text{C}$ , ON/OFF Pin Is Tied to  $V_{IN}$   
 (unless otherwise specified)

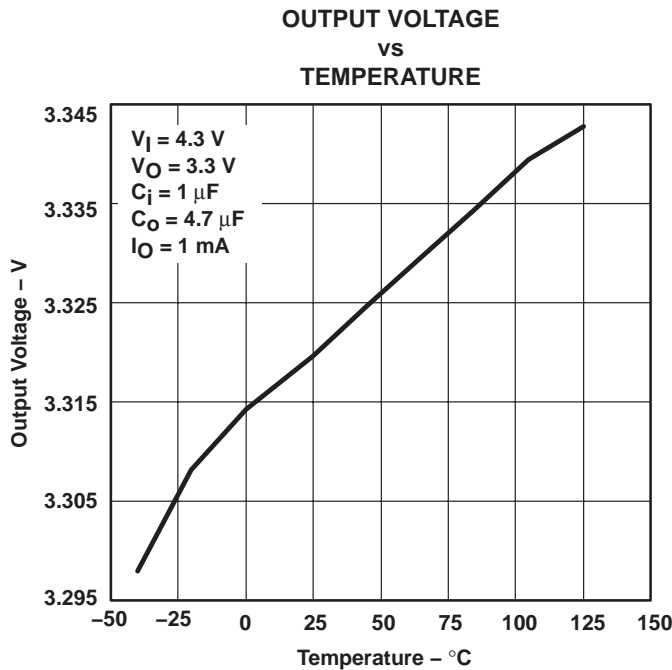

Figure 2

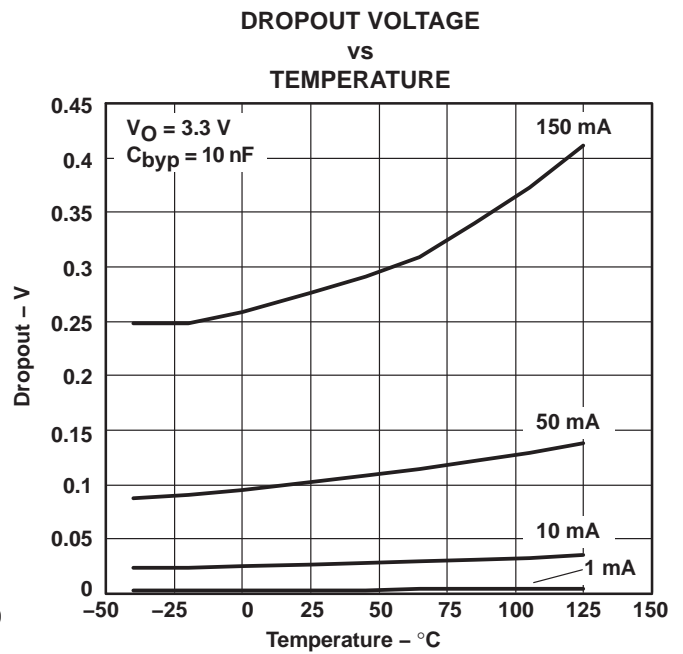

Figure 3

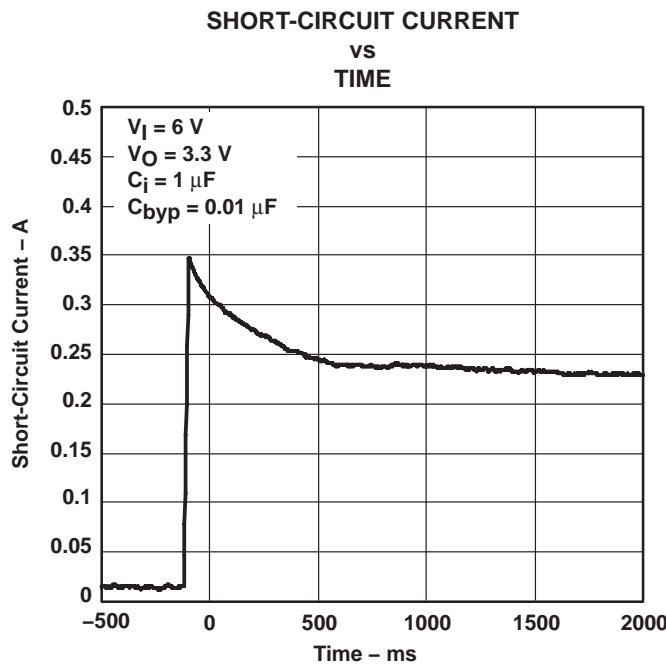

Figure 4

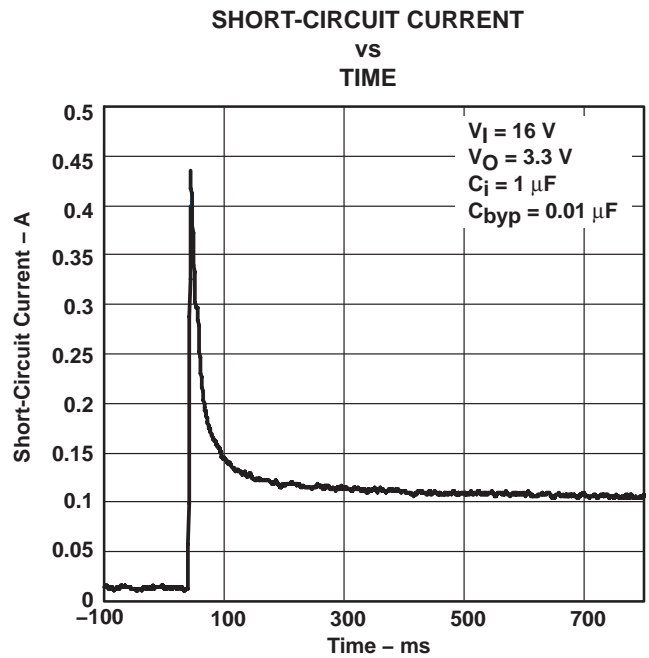

Figure 5

**LP2985**  
**150-mA LOW-NOISE, LOW-DROPOUT REGULATOR**  
**WITH SHUTDOWN**

SLVS522C – JULY 2004 – REVISED OCTOBER 2004

**TYPICAL PERFORMANCE CHARACTERISTICS**  
 $C_{IN} = 1 \mu\text{F}$ ,  $C_{OUT} = 4.7 \mu\text{F}$ ,  $V_{IN} = V_{OUT(NOM)} + 1 \text{ V}$ ,  $T_A = 25^\circ\text{C}$ , ON/OFF Pin Is Tied to  $V_{IN}$   
 (unless otherwise specified)

**SHORT-CIRCUIT CURRENT**  
**vs**  
**OUTPUT VOLTAGE**

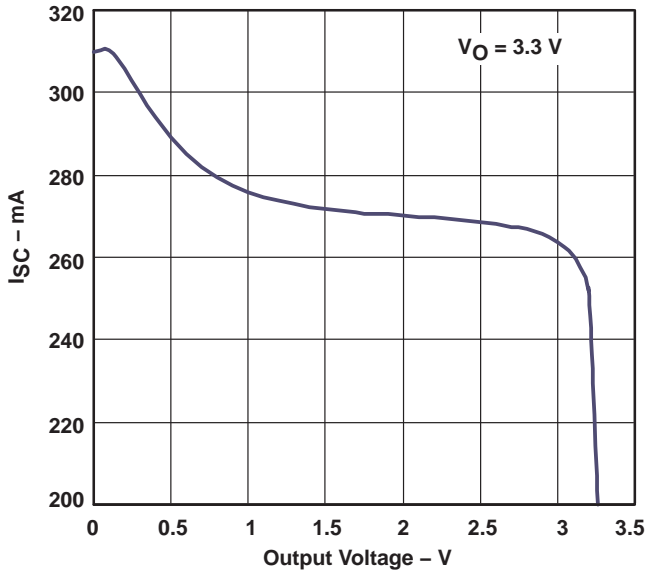

**Figure 6**

**GROUND-PIN CURRENT**  
**vs**  
**LOAD CURRENT**

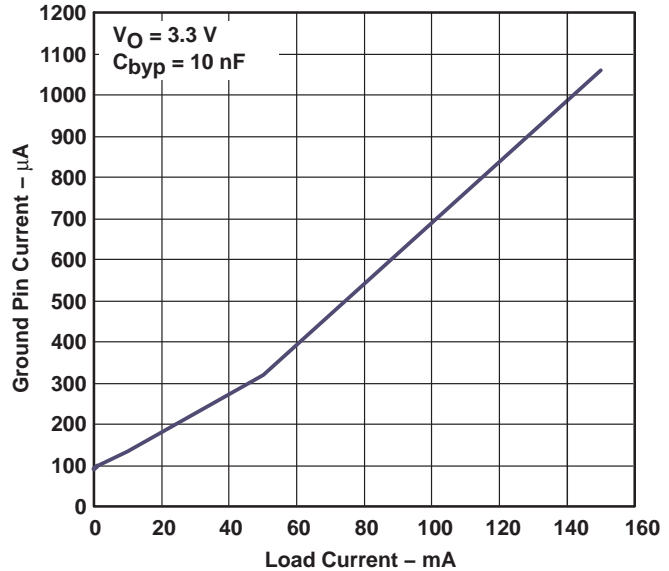

**Figure 7**

**RIPPLE REJECTION**  
**vs**  
**FREQUENCY**

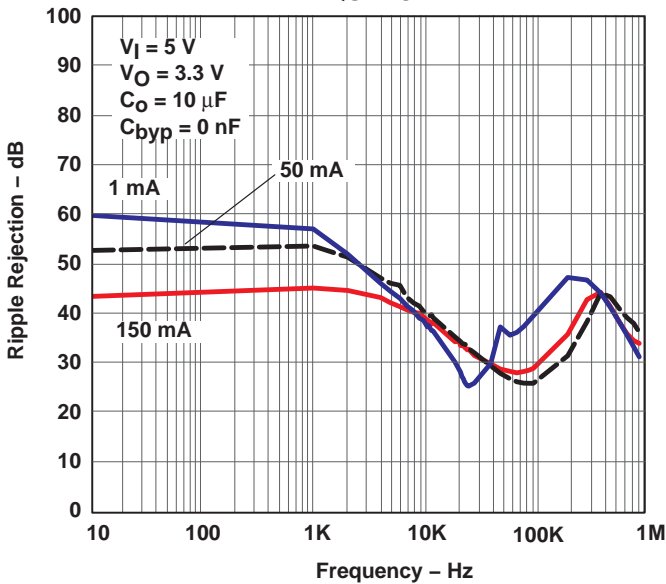

**Figure 8**

**RIPPLE REJECTION**  
**vs**  
**FREQUENCY**

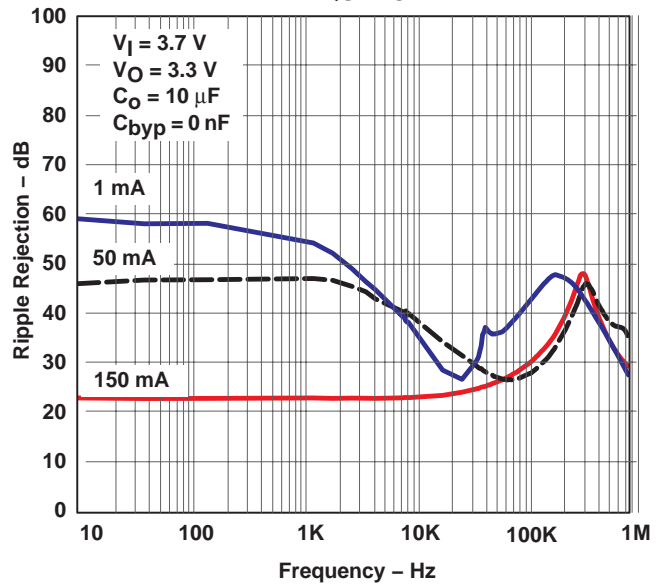

**Figure 9**



# LP2985 150-mA LOW-NOISE, LOW-DROPOUT REGULATOR WITH SHUTDOWN

SLVS522C – JULY 2004 – REVISED OCTOBER 2004

**TYPICAL PERFORMANCE CHARACTERISTICS**  
 $C_{IN} = 1 \mu\text{F}$ ,  $C_{OUT} = 4.7 \mu\text{F}$ ,  $V_{IN} = V_{OUT(NOM)} + 1 \text{ V}$ ,  $T_A = 25^\circ\text{C}$ , ON/OFF Pin Is Tied to  $V_{IN}$   
 (unless otherwise specified)

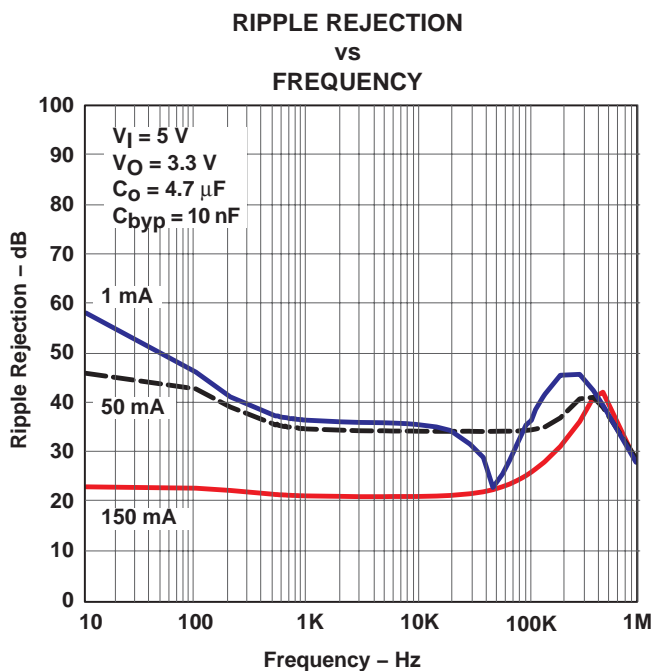

Figure 10

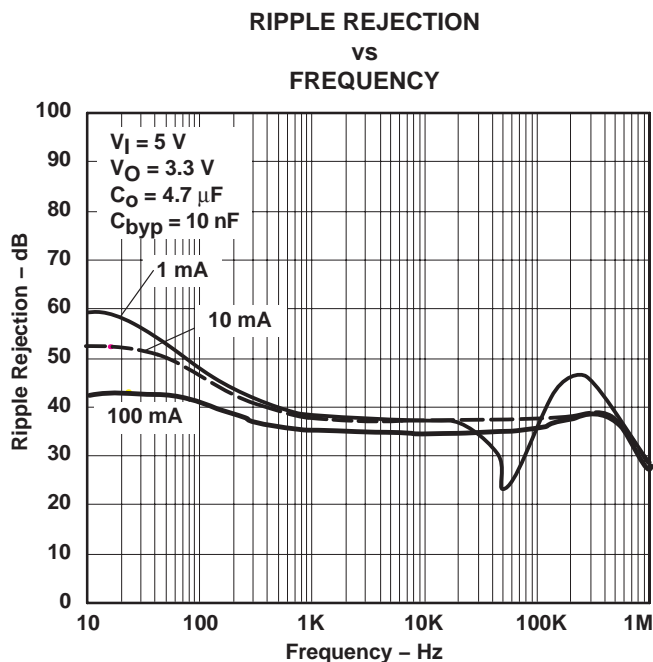

Figure 11

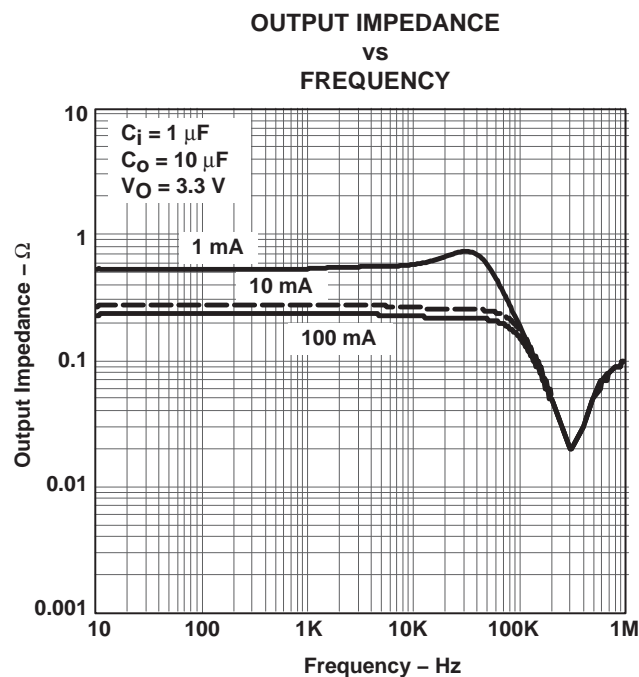

Figure 12

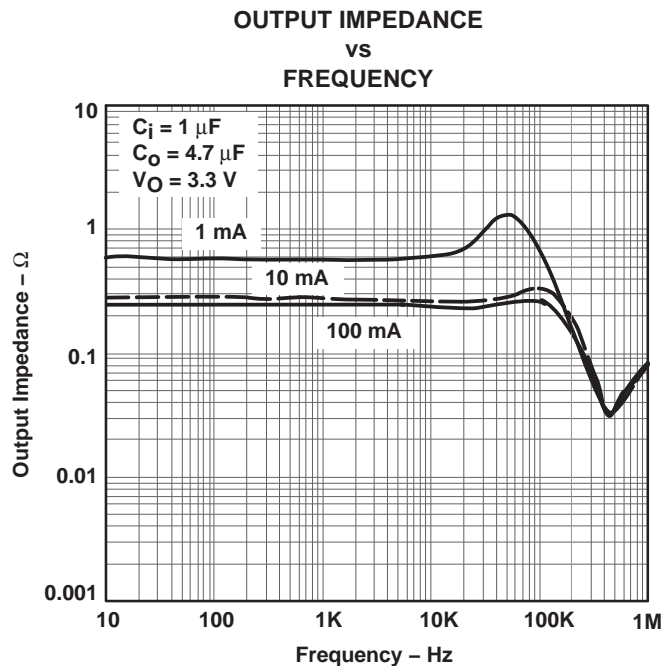

Figure 13

**LP2985**  
**150-mA LOW-NOISE, LOW-DROPOUT REGULATOR**  
**WITH SHUTDOWN**

SLVS522C – JULY 2004 – REVISED OCTOBER 2004

**TYPICAL PERFORMANCE CHARACTERISTICS**  
 $C_{IN} = 1 \mu\text{F}$ ,  $C_{OUT} = 4.7 \mu\text{F}$ ,  $V_{IN} = V_{OUT(NOM)} + 1 \text{ V}$ ,  $T_A = 25^\circ\text{C}$ , ON/OFF Pin Is Tied to  $V_{IN}$   
 (unless otherwise specified)

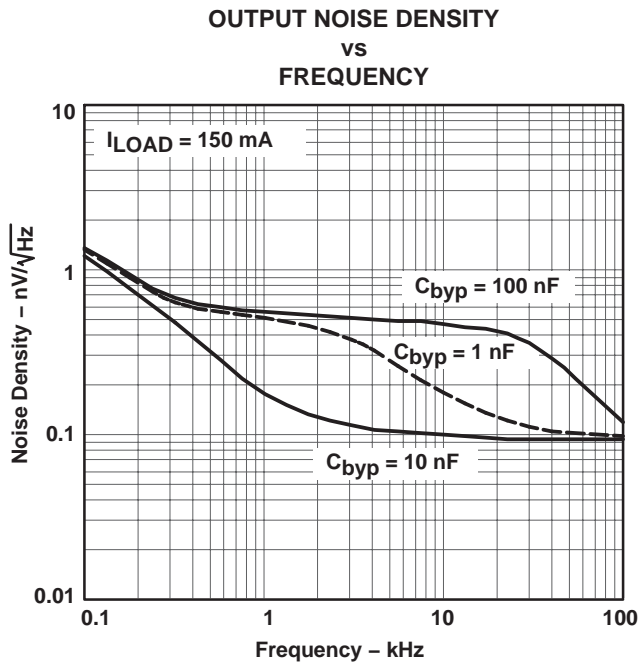

Figure 14

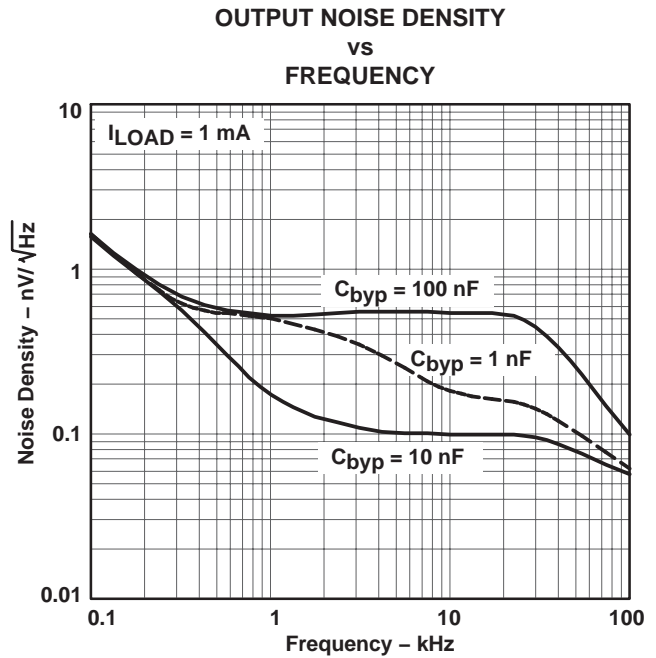

Figure 15

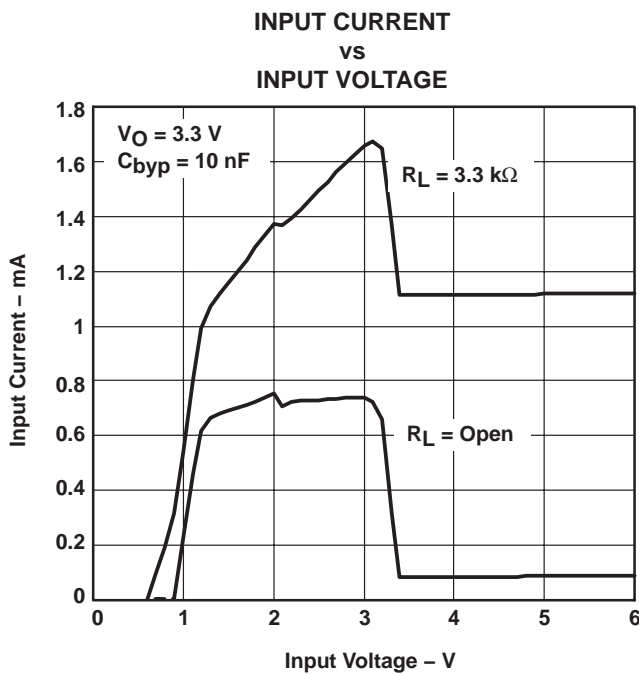

Figure 16

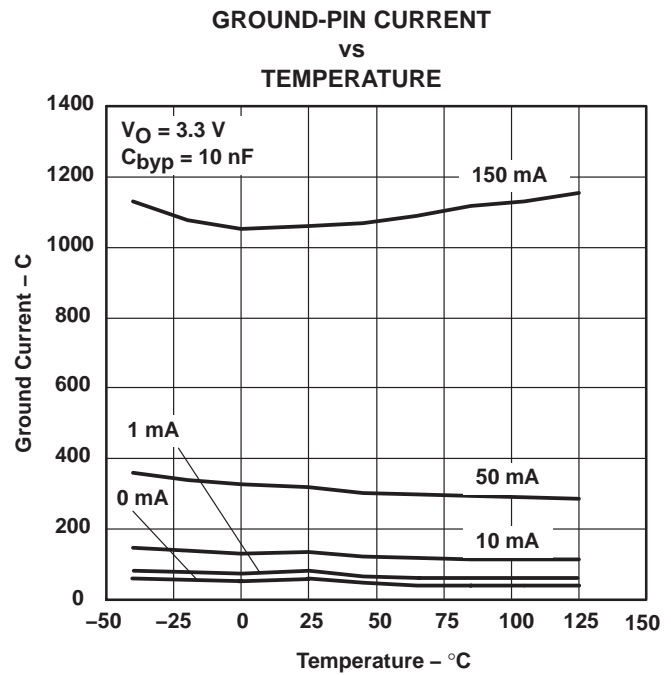

Figure 17





# LP2985 150-mA LOW-NOISE, LOW-DROPOUT REGULATOR WITH SHUTDOWN

SLVS522C – JULY 2004 – REVISED OCTOBER 2004

**TYPICAL PERFORMANCE CHARACTERISTICS**  
 $C_{IN} = 1 \mu\text{F}$ ,  $C_{OUT} = 4.7 \mu\text{F}$ ,  $V_{IN} = V_{OUT(NOM)} + 1 \text{ V}$ ,  $T_A = 25^\circ\text{C}$ , ON/OFF Pin Is Tied to  $V_{IN}$   
 (unless otherwise specified)

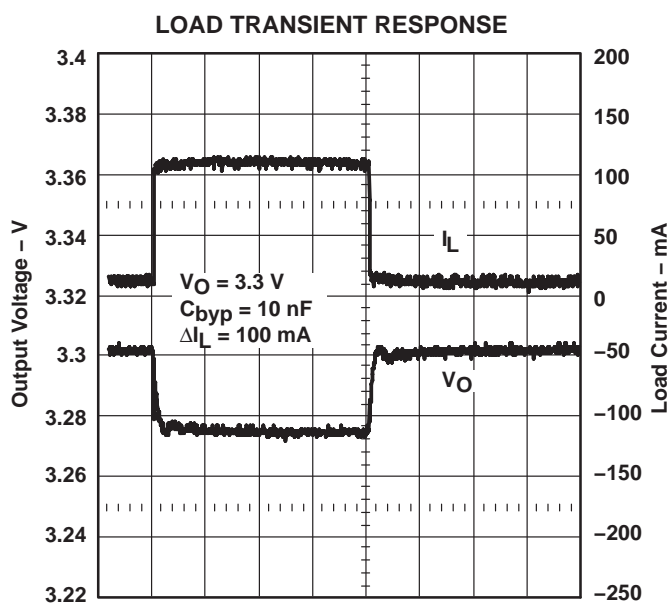

20  $\mu\text{s}/\text{div} \rightarrow$

Figure 18

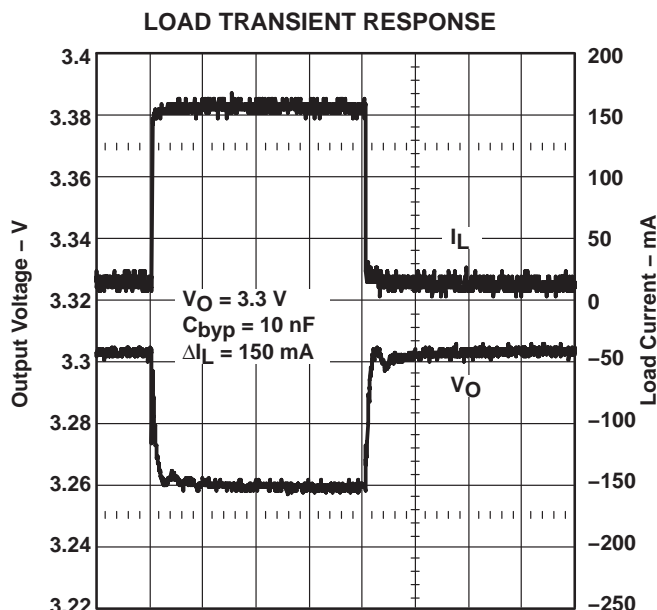

20  $\mu\text{s}/\text{div} \rightarrow$

Figure 19

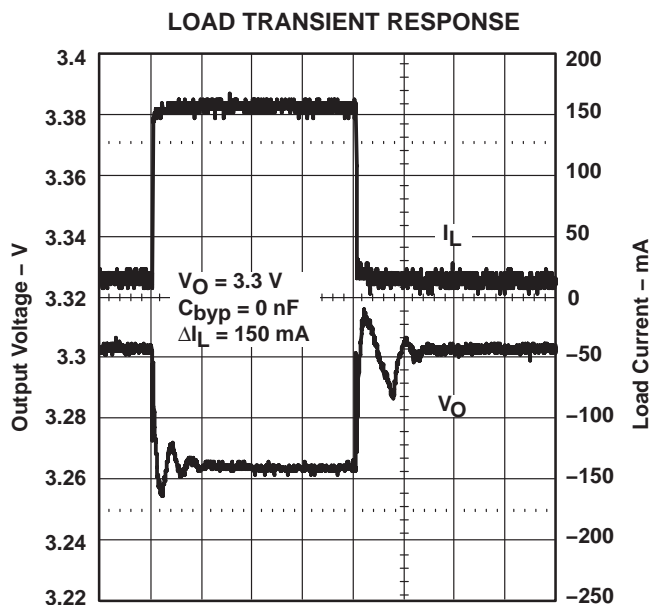

20  $\mu\text{s}/\text{div} \rightarrow$

Figure 20

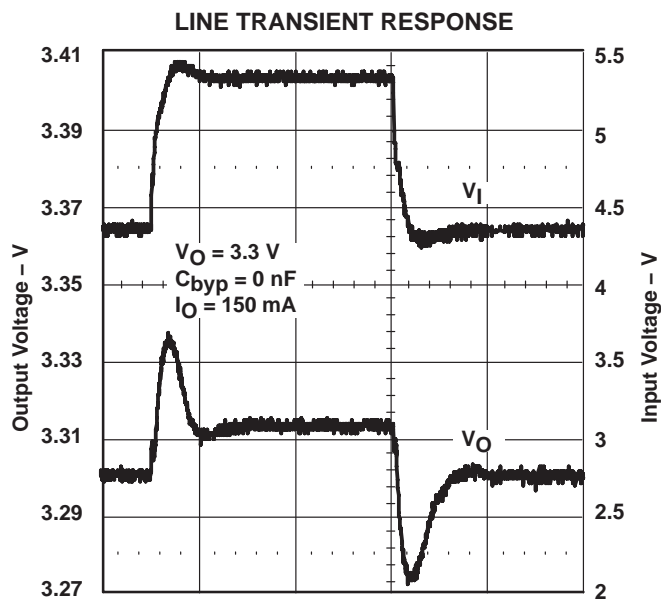

20  $\mu\text{s}/\text{div} \rightarrow$

Figure 21

**LP2985**  
**150-mA LOW-NOISE, LOW-DROPOUT REGULATOR**  
**WITH SHUTDOWN**

SLVS522C – JULY 2004 – REVISED OCTOBER 2004

**TYPICAL PERFORMANCE CHARACTERISTICS**

$C_{IN} = 1 \mu\text{F}$ ,  $C_{OUT} = 4.7 \mu\text{F}$ ,  $V_{IN} = V_{OUT(NOM)} + 1 \text{ V}$ ,  $T_A = 25^\circ\text{C}$ , ON/OFF Pin Is Tied to  $V_{IN}$   
 (unless otherwise specified)

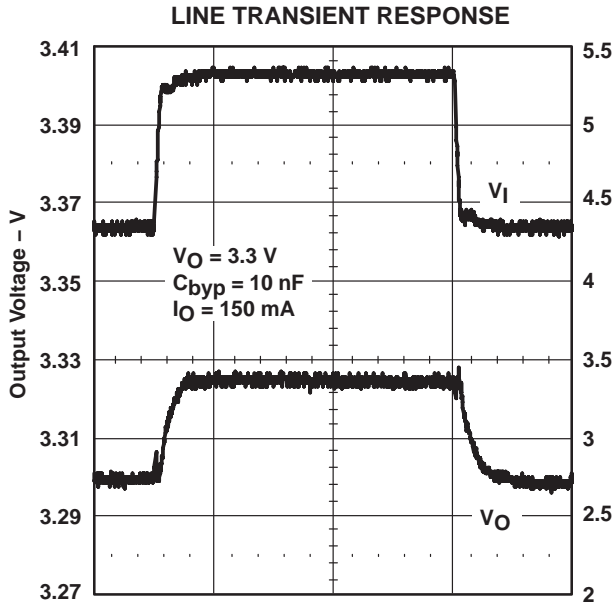

20  $\mu\text{s}/\text{div} \rightarrow$   
**Figure 22**

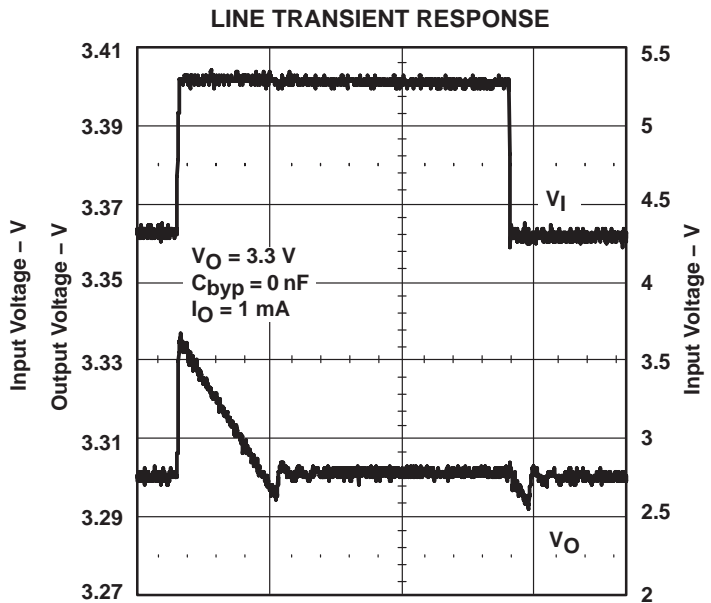

20  $\mu\text{s}/\text{div} \rightarrow$   
**Figure 23**

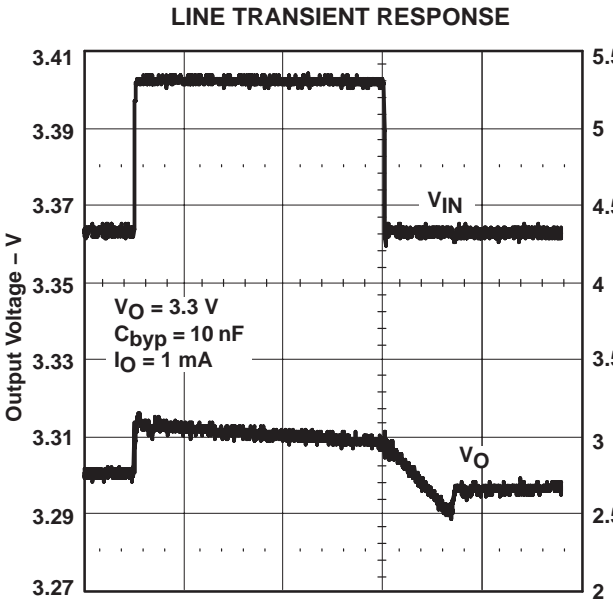

100  $\mu\text{s}/\text{div} \rightarrow$   
**Figure 24**

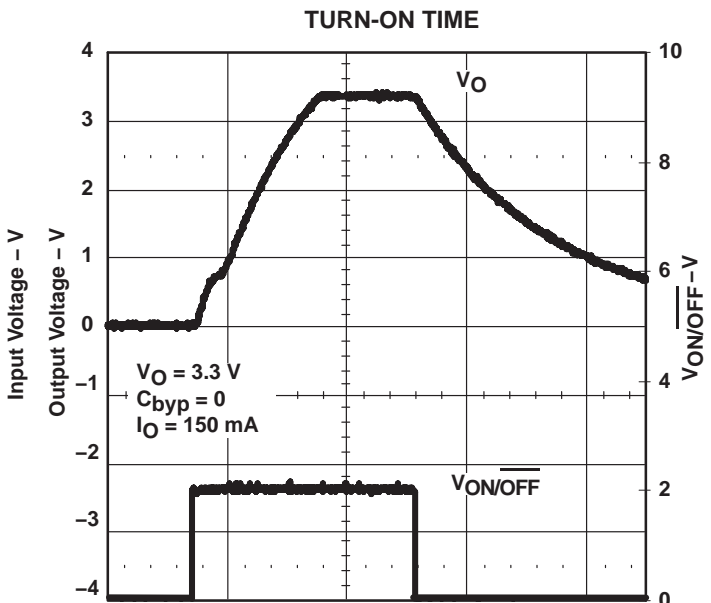

100  $\mu\text{s}/\text{div} \rightarrow$   
**Figure 25**



# LP2985 150-mA LOW-NOISE, LOW-DROPOUT REGULATOR WITH SHUTDOWN

SLVS522C – JULY 2004 – REVISED OCTOBER 2004

**TYPICAL PERFORMANCE CHARACTERISTICS**  
 $C_{IN} = 1 \mu\text{F}$ ,  $C_{OUT} = 4.7 \mu\text{F}$ ,  $V_{IN} = V_{OUT(NOM)} + 1 \text{ V}$ ,  $T_A = 25^\circ\text{C}$ , ON/OFF Pin Is Tied to  $V_{IN}$   
 (unless otherwise specified)

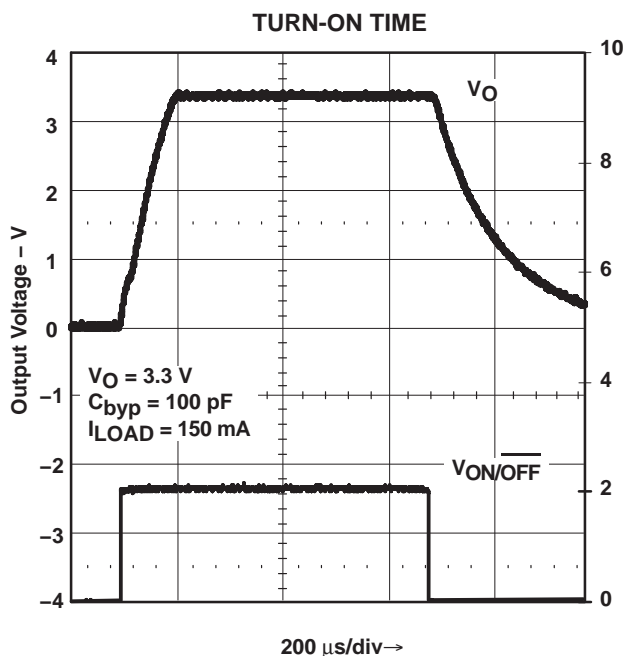

Figure 26

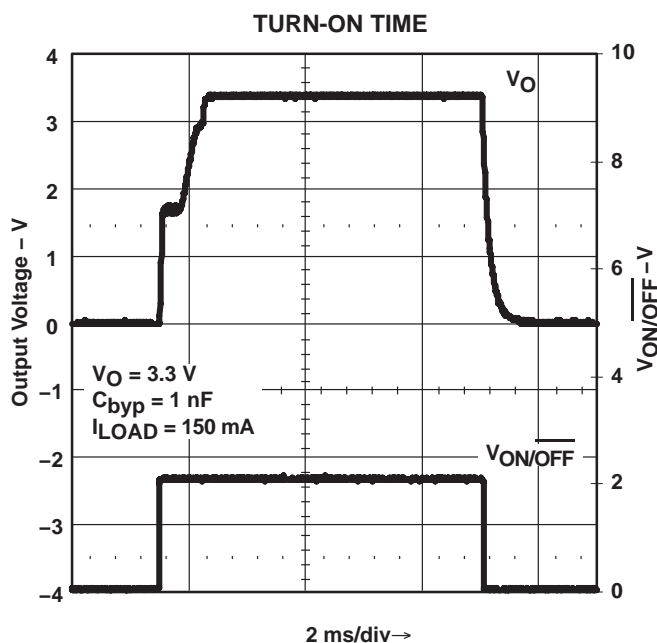

Figure 27

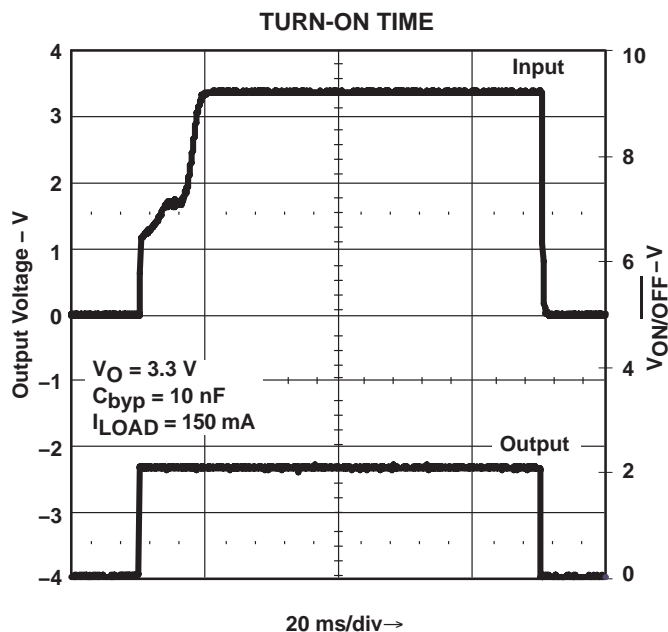

Figure 28

**LP2985**  
**150-mA LOW-NOISE, LOW-DROPOUT REGULATOR**  
**WITH SHUTDOWN**

SLVS522C – JULY 2004 – REVISED OCTOBER 2004

**WAFER CHIP SCALE INFORMATION**

**LP2985x-xxYEQ NanoStar (0.17-mm Bump)**  
**LP2985x-xxYZQ NanoFree (0.17-mm Pb-Free Bump)**

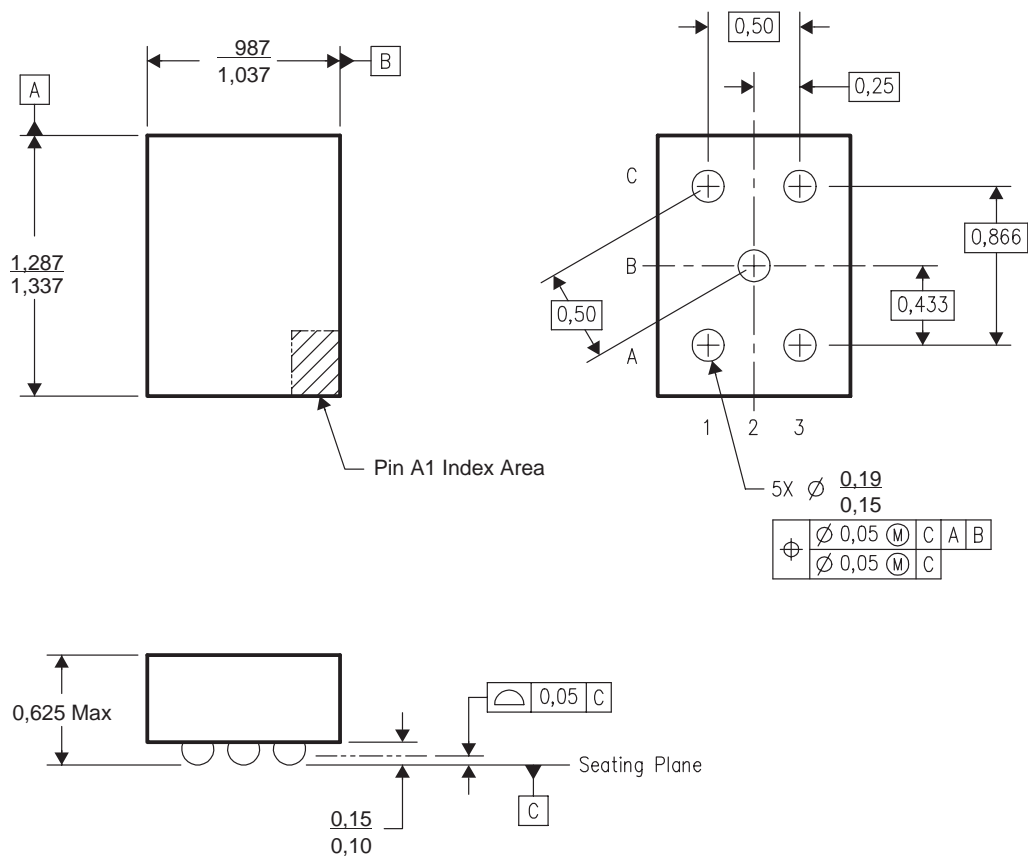

- NOTES: A. All linear dimensions are in millimeters.  
 B. This drawing is subject to change without notice.  
 C. NanoStar package configuration  
 D. This package is tin-lead (SnPb); consult the factory for availability of lead-free material.

# LP2985 150-mA LOW-NOISE, LOW-DROPOUT REGULATOR WITH SHUTDOWN

SLVS522C – JULY 2004 – REVISED OCTOBER 2004

## WAFER CHIP SCALE INFORMATION

**LP2985x-xxYEU NanoStar (0.30-mm Bump)**  
**LP2985x-xxYZU NanoFree (0.30-mm Pb-Free Bump)**

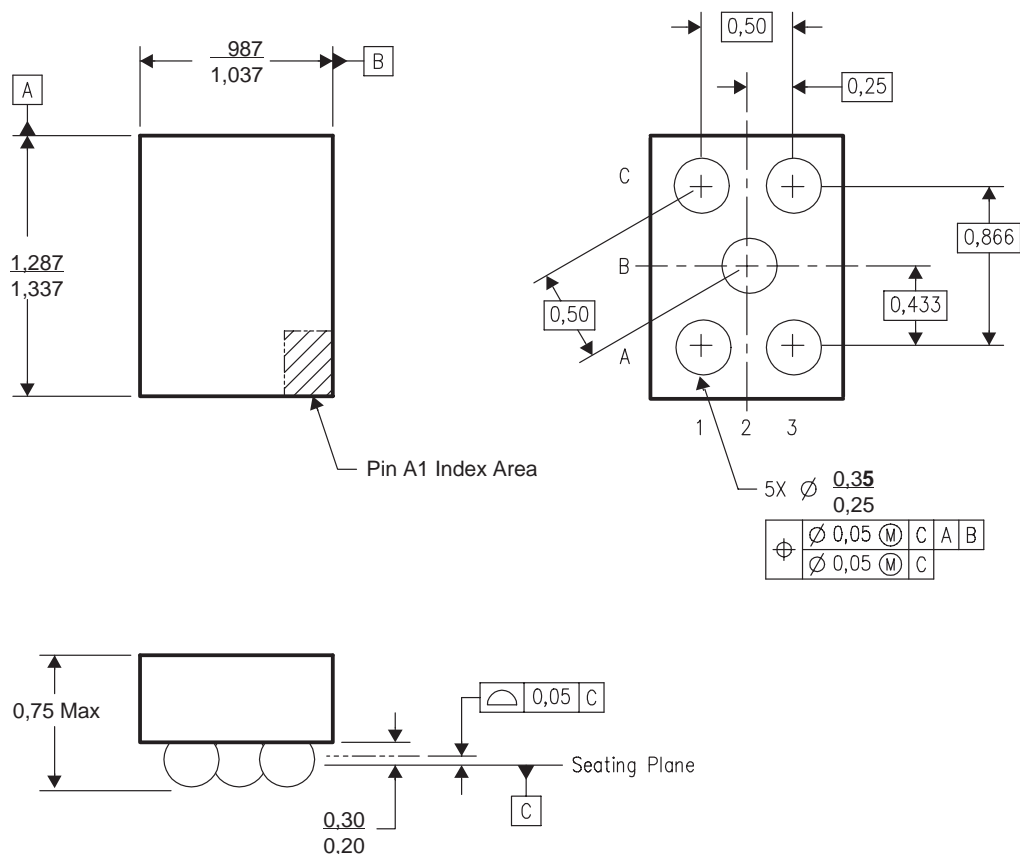

- NOTES: A. All linear dimensions are in millimeters.  
 B. This drawing is subject to change without notice.  
 C. NanoStar package configuration  
 D. This package is tin-lead (SnPb); consult the factory for availability of lead-free material.

DBV (R-PDSO-G5)

PLASTIC SMALL-OUTLINE PACKAGE

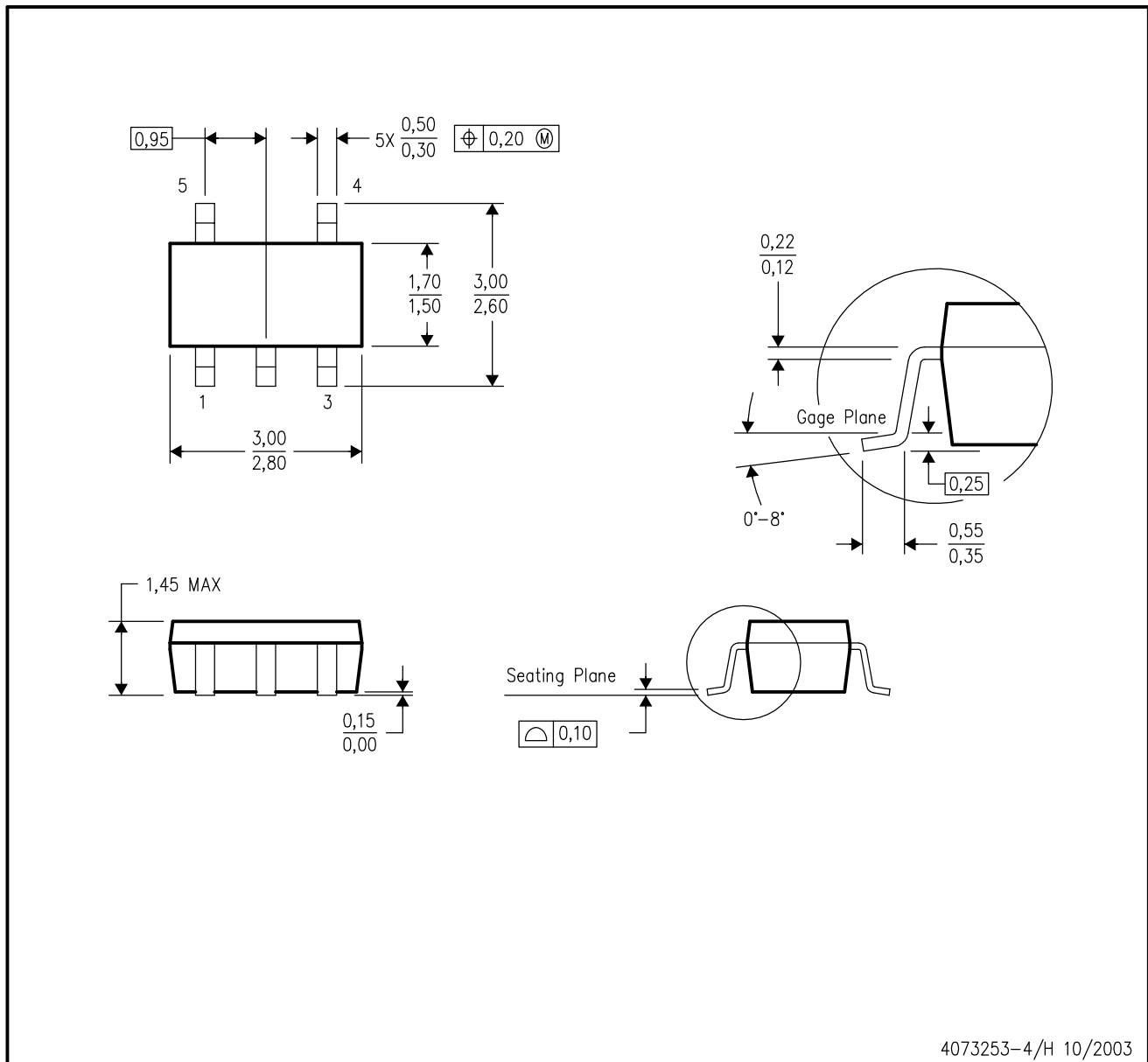

- NOTES:
- A. All linear dimensions are in millimeters.
  - B. This drawing is subject to change without notice.
  - C. Body dimensions do not include mold flash or protrusion.
  - D. Falls within JEDEC MO-178 Variation AA.

## IMPORTANT NOTICE

Texas Instruments Incorporated and its subsidiaries (TI) reserve the right to make corrections, modifications, enhancements, improvements, and other changes to its products and services at any time and to discontinue any product or service without notice. Customers should obtain the latest relevant information before placing orders and should verify that such information is current and complete. All products are sold subject to TI's terms and conditions of sale supplied at the time of order acknowledgment.

TI warrants performance of its hardware products to the specifications applicable at the time of sale in accordance with TI's standard warranty. Testing and other quality control techniques are used to the extent TI deems necessary to support this warranty. Except where mandated by government requirements, testing of all parameters of each product is not necessarily performed.

TI assumes no liability for applications assistance or customer product design. Customers are responsible for their products and applications using TI components. To minimize the risks associated with customer products and applications, customers should provide adequate design and operating safeguards.

TI does not warrant or represent that any license, either express or implied, is granted under any TI patent right, copyright, mask work right, or other TI intellectual property right relating to any combination, machine, or process in which TI products or services are used. Information published by TI regarding third-party products or services does not constitute a license from TI to use such products or services or a warranty or endorsement thereof. Use of such information may require a license from a third party under the patents or other intellectual property of the third party, or a license from TI under the patents or other intellectual property of TI.

Reproduction of information in TI data books or data sheets is permissible only if reproduction is without alteration and is accompanied by all associated warranties, conditions, limitations, and notices. Reproduction of this information with alteration is an unfair and deceptive business practice. TI is not responsible or liable for such altered documentation.

Resale of TI products or services with statements different from or beyond the parameters stated by TI for that product or service voids all express and any implied warranties for the associated TI product or service and is an unfair and deceptive business practice. TI is not responsible or liable for any such statements.

Following are URLs where you can obtain information on other Texas Instruments products and application solutions:

<b>Products</b>		<b>Applications</b>	
Amplifiers	<a href="http://amplifier.ti.com">amplifier.ti.com</a>	Audio	<a href="http://www.ti.com/audio">www.ti.com/audio</a>
Data Converters	<a href="http://dataconverter.ti.com">dataconverter.ti.com</a>	Automotive	<a href="http://www.ti.com/automotive">www.ti.com/automotive</a>
DSP	<a href="http://dsp.ti.com">dsp.ti.com</a>	Broadband	<a href="http://www.ti.com/broadband">www.ti.com/broadband</a>
Interface	<a href="http://interface.ti.com">interface.ti.com</a>	Digital Control	<a href="http://www.ti.com/digitalcontrol">www.ti.com/digitalcontrol</a>
Logic	<a href="http://logic.ti.com">logic.ti.com</a>	Military	<a href="http://www.ti.com/military">www.ti.com/military</a>
Power Mgmt	<a href="http://power.ti.com">power.ti.com</a>	Optical Networking	<a href="http://www.ti.com/opticalnetwork">www.ti.com/opticalnetwork</a>
Microcontrollers	<a href="http://microcontroller.ti.com">microcontroller.ti.com</a>	Security	<a href="http://www.ti.com/security">www.ti.com/security</a>
		Telephony	<a href="http://www.ti.com/telephony">www.ti.com/telephony</a>
		Video & Imaging	<a href="http://www.ti.com/video">www.ti.com/video</a>
		Wireless	<a href="http://www.ti.com/wireless">www.ti.com/wireless</a>

Mailing Address: Texas Instruments  
Post Office Box 655303 Dallas, Texas 75265