

## LP2992 Micropower 250 mA Low-Noise Ultra Low-Dropout Regulator in SOT-23 and WSON Packages Designed for Use with Very Low ESR Output Capacitors

Check for Samples: [LP2992](#)

### FEATURES

- Ultra Low Dropout Voltage
- Specified 250 mA Output Current
- Smallest Possible Size (SOT-23, WSON Package)
- Requires Minimum External Components
- Stable with Low-ESR Output Capacitor
- <1  $\mu\text{A}$  Quiescent Current when Shut Down
- Low Ground Pin Current at all Loads
- Output Voltage Accuracy 1% (A Grade)
- High Peak Current Capability
- Wide Supply Voltage Range (16V Max)
- Low  $Z_{\text{OUT}}$ : 0.3 $\Omega$  Typical (10 Hz to 1 MHz)
- Overtemperature/overcurrent Protection
- $-40^{\circ}\text{C}$  to  $+125^{\circ}\text{C}$  Junction Temperature Range
- Custom Voltages Available

### APPLICATIONS

- Cellular Phone
- Palmtop/Laptop Computer
- Personal Digital Assistant (PDA)
- Camcorder, Personal Stereo, Camera

### DESCRIPTION

The LP2992 is a 250 mA, fixed-output voltage regulator designed to provide ultra low-dropout and low noise in battery powered applications.

Using an optimized VIP (Vertically Integrated PNP) process, the LP2992 delivers unequaled performance in all specifications critical to battery-powered designs:

**Dropout Voltage:** Typically 450 mV @ 250 mA load, and 5 mV @ 1 mA load.

**Ground Pin Current:** Typically 1500  $\mu\text{A}$  @ 250 mA load, and 75  $\mu\text{A}$  @ 1 mA load.

**Enhanced Stability:** The LP2992 is stable with output capacitor ESR as low as 5 m $\Omega$ , which allows the use of ceramic capacitors on the output.

**Sleep Mode:** Less than 1  $\mu\text{A}$  quiescent current when ON/OFF pin is pulled low.

**Smallest Possible Size:** SOT-23 and WSON packages use absolute minimum board space.

**Precision Output:** 1% tolerance output voltages available (A grade).

**Low Noise:** By adding a 10 nF bypass capacitor, output noise can be reduced to 30  $\mu\text{V}$  (typical).

Multiple voltage options, from 1.5V to 5.0V, are available as standard products. Consult factory for custom voltages.

### Block Diagram

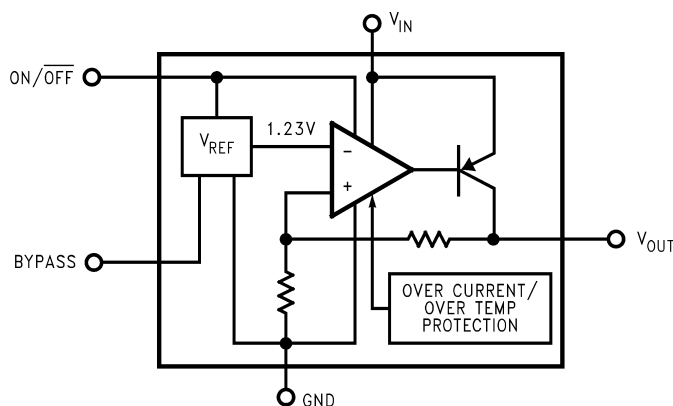

Please be aware that an important notice concerning availability, standard warranty, and use in critical applications of Texas Instruments semiconductor products and disclaimers thereto appears at the end of this data sheet.

All trademarks are the property of their respective owners.

### Basic Application Circuit

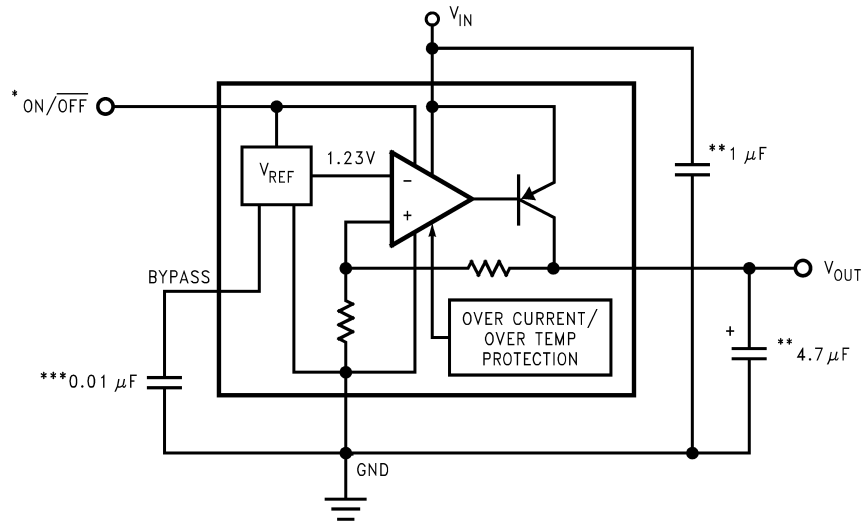

\*ON/OFF input must be actively terminated. Tie to  $V_{IN}$  if this function is not to be used.  
 \*\*Minimum capacitance is shown to ensure stability (may be increased without limit). Ceramic capacitor required for output (see [Application Hints](#)).  
 \*\*\*Reduces output noise (may be omitted if application is not noise critical). Use ceramic or film type with very low leakage current (see [Application Hints](#)).

### Connection Diagram

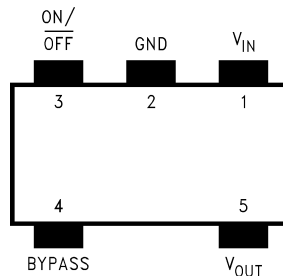

**Figure 1. Top View  
5-Lead SOT-23 (DBV)  
See Package Number DBV0005A**

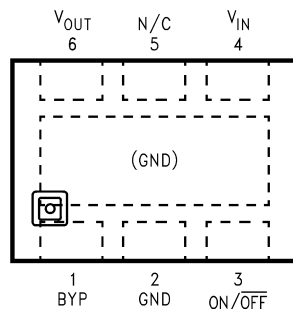

**Figure 2. Top View  
6-Lead WSON Package (NGD)  
See Package Number NGD0006A**



These devices have limited built-in ESD protection. The leads should be shorted together or the device placed in conductive foam during storage or handling to prevent electrostatic damage to the MOS gates.

### Absolute Maximum Ratings<sup>(1)(2)</sup>

Storage Temperature Range	-65°C to +150°C
Operating Junction Temperature Range	-40°C to +125°C
Lead Temp. (Soldering, 5 sec.)	260°C
ESD Rating <sup>(3)</sup>	2 kV
Power Dissipation <sup>(4)</sup>	Internally Limited
Input Supply Voltage (Survival)	-0.3V to +16V
Input Supply Voltage (Operating)	2.2V to +16V
Shutdown Input Voltage (Survival)	-0.3V to +16V
Output Voltage (Survival, <sup>(5)</sup> )	-0.3V to +9V
I <sub>OUT</sub> (Survival)	Short Circuit Protected
Input-Output Voltage (Survival, <sup>(6)</sup> )	-0.3V to +16V

- (1) "Absolute Maximum Ratings" indicate limits beyond which damage to the component may occur. Electrical specifications do not apply when operating the device outside of its rated operating conditions.
- (2) If Military/Aerospace specified devices are required, please contact the Texas Instruments Sales Office/Distributors for availability and specifications.
- (3) The ESD rating of pins 3 and 4 for the SOT-23 package, or pins 1 and 3 for the WSON package, is 1 kV.
- (4) The maximum allowable power dissipation is a function of the maximum junction temperature, T<sub>J</sub>(MAX), the junction-to-ambient thermal resistance, θ<sub>J-A</sub>, and the ambient temperature, T<sub>A</sub>. The maximum allowable power dissipation at any ambient temperature is calculated using:  

$$P(MAX) = \frac{T_J(MAX) - T_A}{\theta_{J-A}}$$
 Where the value of θ<sub>J-A</sub> for the SOT-23 package is 220°C/W in a typical PC board mounting and the WSON package is 65°C/W. Exceeding the maximum allowable dissipation will cause excessive die temperature, and the regulator will go into thermal shutdown.
- (5) If used in a dual-supply system where the regulator load is returned to a negative supply, the LP2992 output must be diode-clamped to ground.
- (6) The output PNP structure contains a diode between the V<sub>IN</sub> to V<sub>OUT</sub> terminals that is normally reverse-biased. Reversing the polarity from V<sub>IN</sub> to V<sub>OUT</sub> will turn on this diode.

### Electrical Characteristics

Limits in standard typeface are for T<sub>J</sub> = 25°C. and limits in **boldface type** apply over the full operating temperature range. Unless otherwise specified: V<sub>IN</sub> = V<sub>O</sub>(NOM) + 1V, I<sub>L</sub> = 1 mA, C<sub>IN</sub> = 1 μF, C<sub>OUT</sub> = 4.7 μF, V<sub>ON/OFF</sub> = 2V.

Symbol	Parameter	Conditions	Typ	LP2992AI-X.X		LP2992I-X.X		Units
				(1)		(1)		
				Min	Max	Min	Max	
ΔV <sub>O</sub>	Output Voltage Tolerance	I <sub>L</sub> = 1 mA		-1.0	1.0	-1.5	1.5	%V <sub>NOM</sub>
		1 mA ≤ I <sub>L</sub> ≤ 50 mA		-1.5	1.5	-2.5	2.5	
		1 mA ≤ I <sub>L</sub> ≤ 250 mA		<b>-2.5</b>	<b>2.5</b>	<b>-3.5</b>	<b>3.5</b>	
ΔV <sub>O</sub> /ΔV <sub>IN</sub>	Output Voltage Line Regulation	V <sub>O</sub> (NOM)+1V ≤ V <sub>IN</sub> ≤ 16V	0.007		0.014		0.014	%V
					<b>0.032</b>		<b>0.032</b>	
V <sub>IN</sub> (min)	Minimum input voltage required to maintain output regulation		2.05		<b>2.20</b>		<b>2.20</b>	V

(1) Limits are 100% production tested at 25°C. Limits over the operating temperature range are specified through correlation using Statistical Quality Control (SQC) methods. The limits are used to calculate TI's Average Outgoing Quality Level (AOQL).

## Electrical Characteristics (continued)

Limits in standard typeface are for  $T_J = 25^\circ\text{C}$ , and limits in **boldface type** apply over the full operating temperature range. Unless otherwise specified:  $V_{IN} = V_O(\text{NOM}) + 1\text{V}$ ,  $I_L = 1\text{ mA}$ ,  $C_{IN} = 1\ \mu\text{F}$ ,  $C_{OUT} = 4.7\ \mu\text{F}$ ,  $V_{ON/OFF} = 2\text{V}$ .

Symbol	Parameter	Conditions	Typ	LP2992AI-X.X		LP2992I-X.X		Units
				(1)		(1)		
				Min	Max	Min	Max	
$V_{IN}-V_O$	Dropout Voltage (2)	$I_L = 0$	0.5		2.5 <b>4</b>		2.5 <b>4</b>	mV
		$I_L = 1\text{ mA}$	5		9 <b>12</b>		9 <b>12</b>	
		$I_L = 50\text{ mA}$	100		125 <b>180</b>		125 <b>180</b>	
		$I_L = 150\text{ mA}$	260		325 <b>470</b>		325 <b>470</b>	
		$I_L = 250\text{ mA}$	450		575 <b>850</b>		575 <b>850</b>	
$I_{GND}$	Ground Pin Current	$I_L = 0$	65		95 <b>125</b>		95 <b>125</b>	$\mu\text{A}$
		$I_L = 1\text{ mA}$	75		110 <b>170</b>		110 <b>170</b>	
		$I_L = 50\text{ mA}$	350		600 <b>1000</b>		600 <b>1000</b>	
		$I_L = 150\text{ mA}$	850		1500 <b>2500</b>		1500 <b>2500</b>	
		$I_L = 250\text{ mA}$	1500		2300 <b>4000</b>		2300 <b>4000</b>	
		$V_{ON/OFF} < 0.3\text{V}$	0.01		0.8		0.8	
		$V_{ON/OFF} < 0.15\text{V}$	<b>0.05</b>		<b>2</b>		<b>2</b>	
$V_{ON/OFF}$	ON/OFF Input Voltage (3)	High = O/P ON	1.4	<b>1.6</b>		<b>1.6</b>		V
		Low = O/P OFF	0.55		<b>0.15</b>		<b>0.15</b>	
$I_{ON/OFF}$	ON/OFF Input Current	$V_{ON/OFF} = 0$	0.01		<b>-2</b>		<b>-2</b>	$\mu\text{A}$
		$V_{ON/OFF} = 5\text{V}$	5		<b>15</b>		<b>15</b>	
$e_n$	Output Noise Voltage (RMS)	BW = 300 Hz to 50 kHz, $C_{OUT} = 10\ \mu\text{F}$ $C_{BYPASS} = 10\ \text{nF}$	30					$\mu\text{V}$
$\Delta V_{OUT}/\Delta V_{IN}$	Ripple Rejection	$f = 1\ \text{kHz}$ , $C_{BYPASS} = 10\ \text{nF}$ $C_{OUT} = 10\ \mu\text{F}$	45					dB
$I_O(\text{SC})$	Short Circuit Current	$R_L = 0$ (Steady State)	400					mA
		(4)						
$I_O(\text{PK})$	Peak Output Current	$V_{OUT} \geq V_O(\text{NOM}) - 5\%$	350					mA

- (2)  $V_{IN}$  must be the greater of 2.2V or  $V_{OUT(\text{nom})} + \text{Dropout Voltage}$  to maintain output regulation. Dropout voltage is defined as the input to output differential at which the output voltage drops 2% below the value measured with a 1V differential.
- (3) The ON/OFF input must be properly driven to prevent possible misoperation. For details, refer to Application Hints.
- (4) The LP2992 has foldback current limiting which allows a high peak current when  $V_{OUT} > 0.5\text{V}$ , and then reduces the maximum output current as  $V_{OUT}$  is forced to ground (see [Typical Performance Characteristics](#) curves).

### Typical Performance Characteristics

Unless otherwise specified:  $C_{IN} = 1\mu F$ ,  $C_{OUT} = 4.7\mu F$ ,  $V_{IN} = V_{OUT(NOM)} + 1$ ,  $T_A = 25^\circ C$ , ON/OFF pin is tied to  $V_{IN}$ .

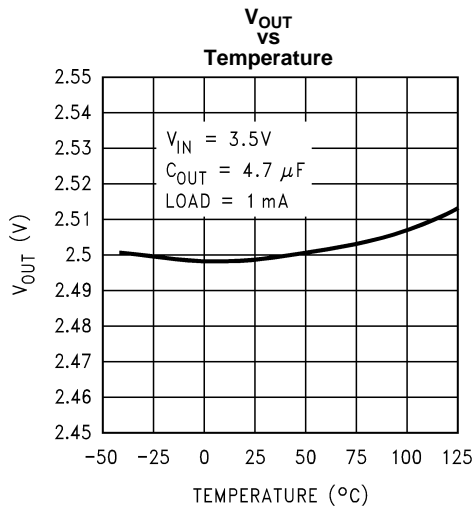

Figure 3.

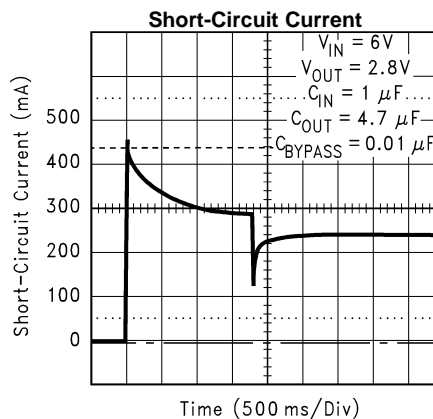

Figure 4.

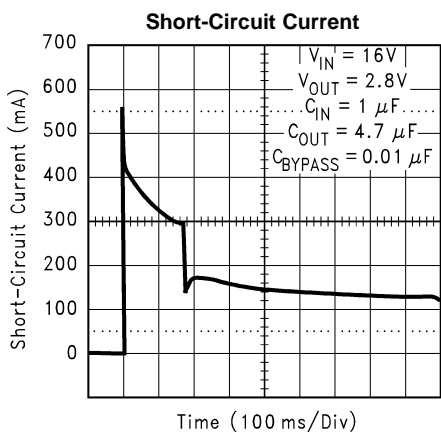

Figure 5.

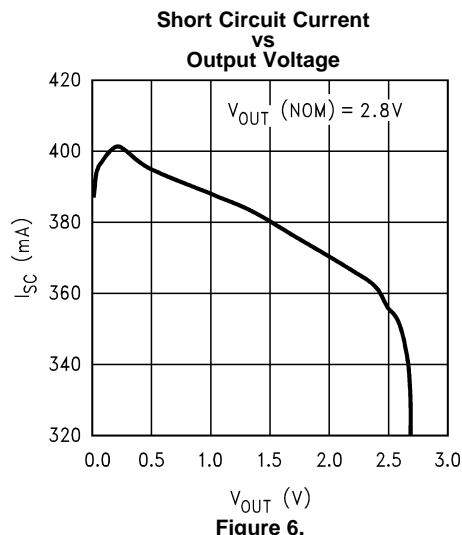

Figure 6.

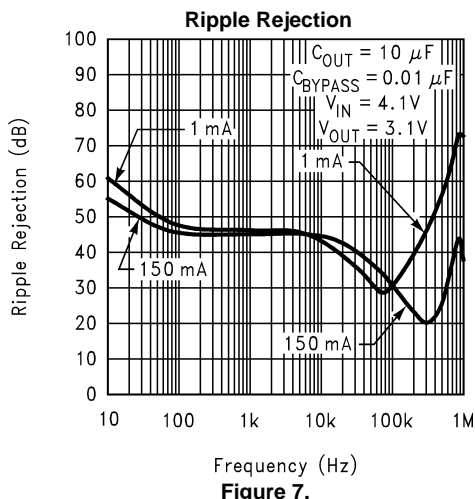

Figure 7.

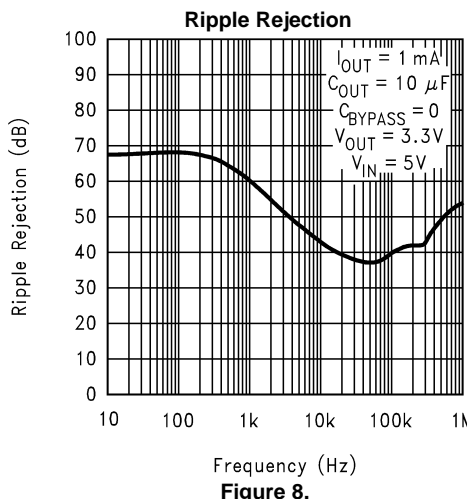

Figure 8.

### Typical Performance Characteristics (continued)

Unless otherwise specified:  $C_{IN} = 1\mu F$ ,  $C_{OUT} = 4.7\mu F$ ,  $V_{IN} = V_{OUT(NOM)} + 1$ ,  $T_A = 25^\circ C$ , ON/OFF pin is tied to  $V_{IN}$ .

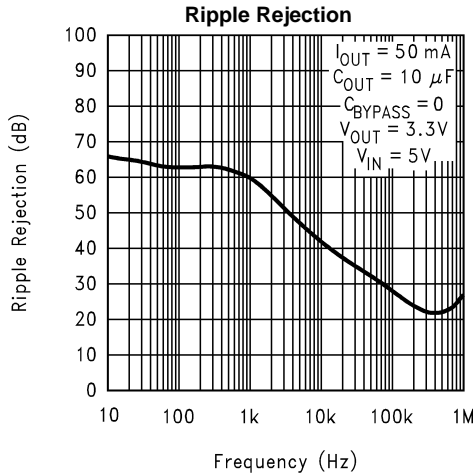

Figure 9.

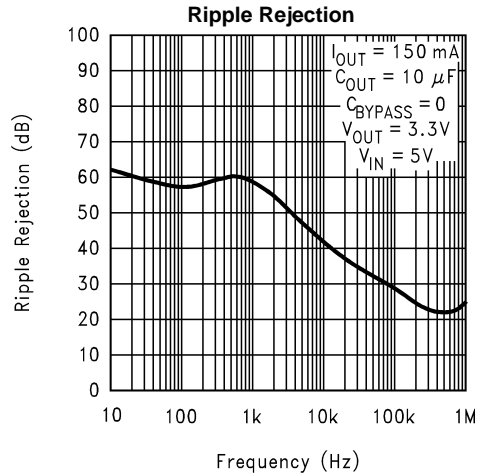

Figure 10.

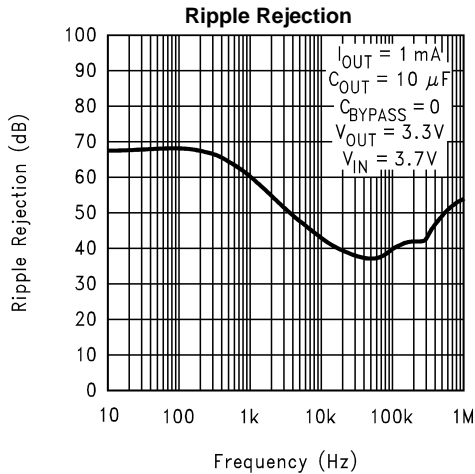

Figure 11.

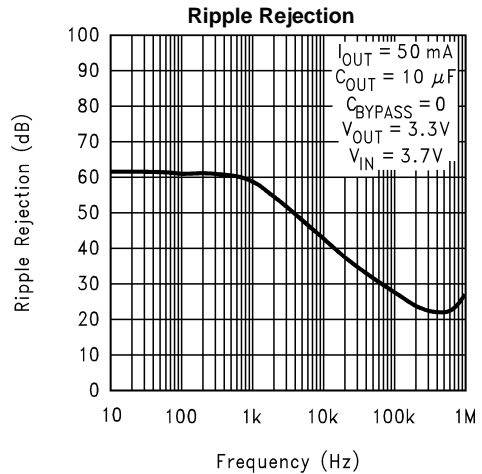

Figure 12.

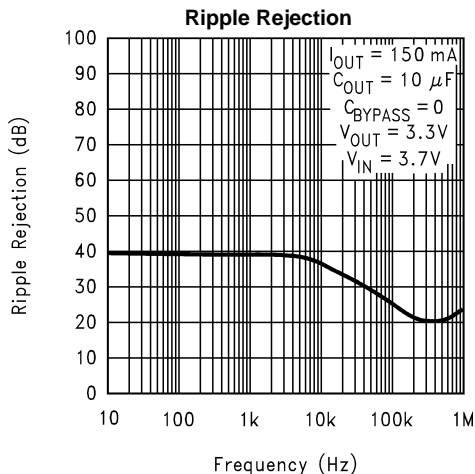

Figure 13.

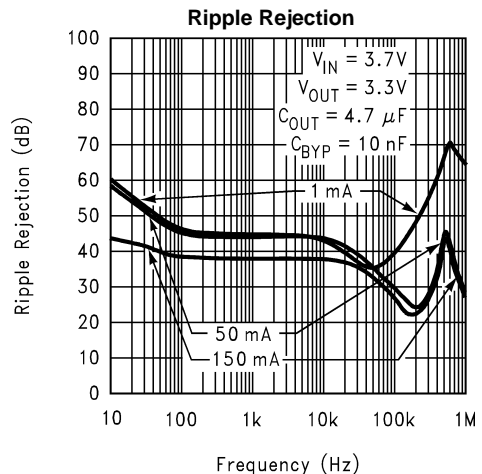

Figure 14.

**Typical Performance Characteristics (continued)**

Unless otherwise specified:  $C_{IN} = 1\mu F$ ,  $C_{OUT} = 4.7\mu F$ ,  $V_{IN} = V_{OUT(NOM)} + 1$ ,  $T_A = 25^\circ C$ , ON/OFF pin is tied to  $V_{IN}$ .

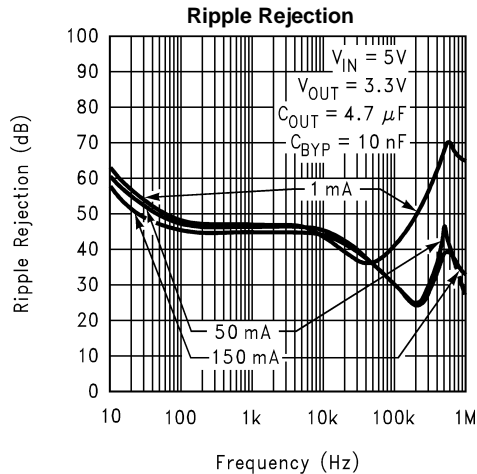

Figure 15.

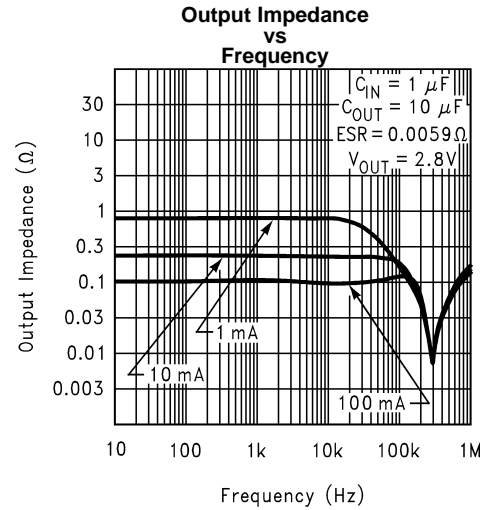

Figure 16.

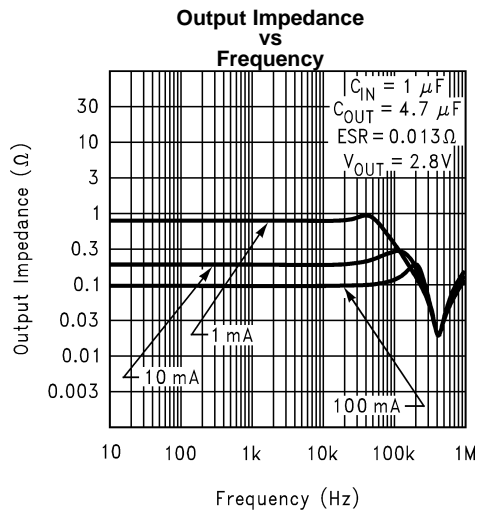

Figure 17.

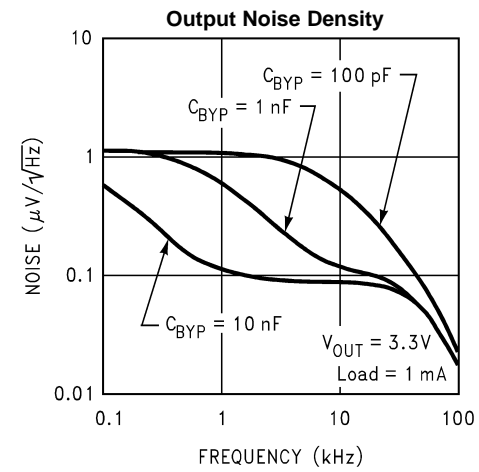

Figure 18.

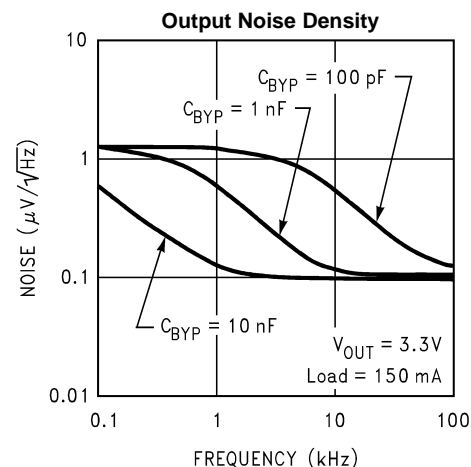

Figure 19.

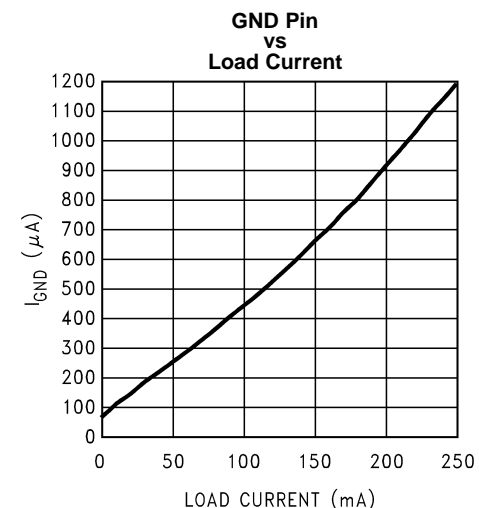

Figure 20.

**Typical Performance Characteristics (continued)**

Unless otherwise specified:  $C_{IN} = 1\mu F$ ,  $C_{OUT} = 4.7\mu F$ ,  $V_{IN} = V_{OUT(NOM)} + 1$ ,  $T_A = 25^\circ C$ , ON/OFF pin is tied to  $V_{IN}$ .

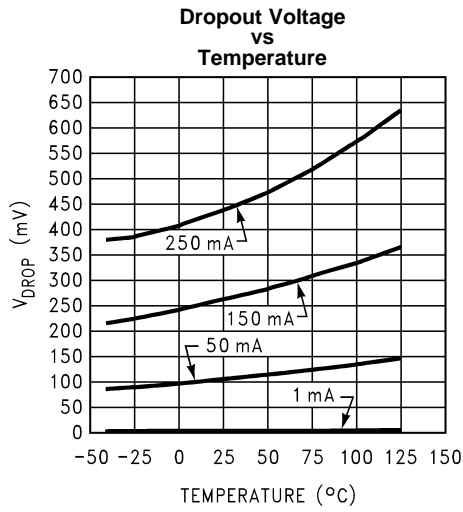

Figure 21.

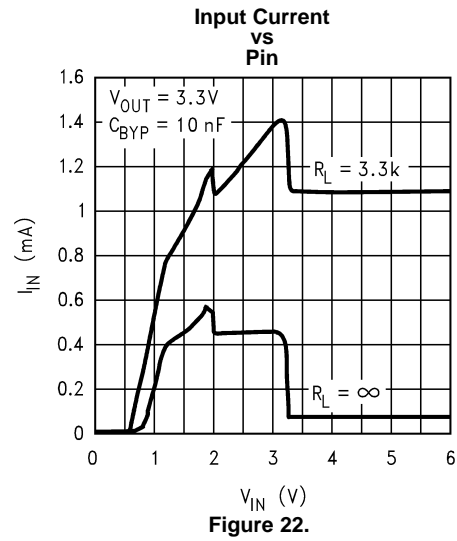

Figure 22.

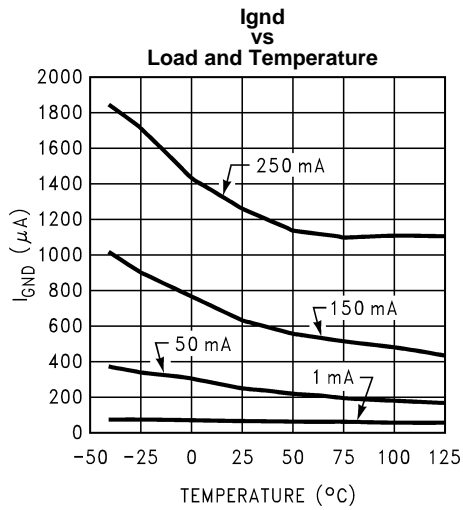

Figure 23.

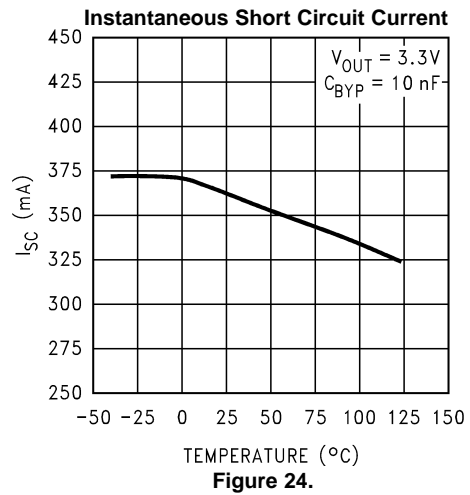

Figure 24.

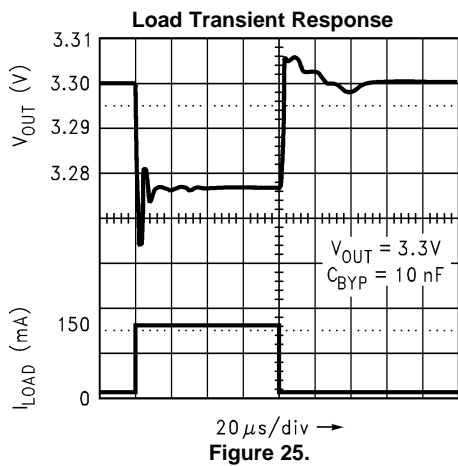

Figure 25.

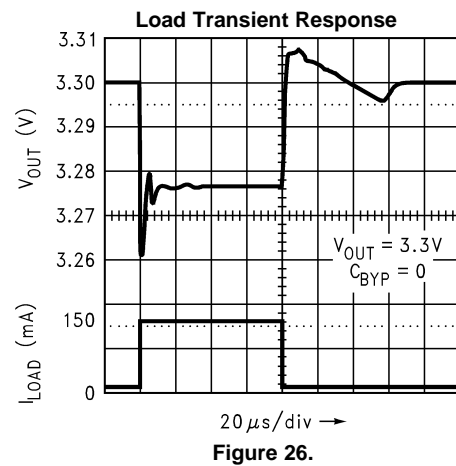

Figure 26.



**Typical Performance Characteristics (continued)**

Unless otherwise specified:  $C_{IN} = 1\mu\text{F}$ ,  $C_{OUT} = 4.7\mu\text{F}$ ,  $V_{IN} = V_{OUT}(\text{NOM}) + 1$ ,  $T_A = 25^\circ\text{C}$ , ON/OFF pin is tied to  $V_{IN}$ .

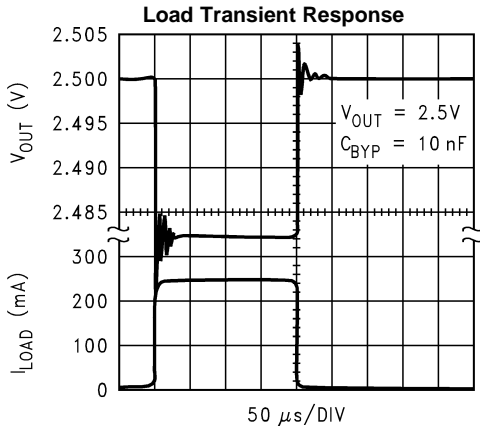

Figure 27.

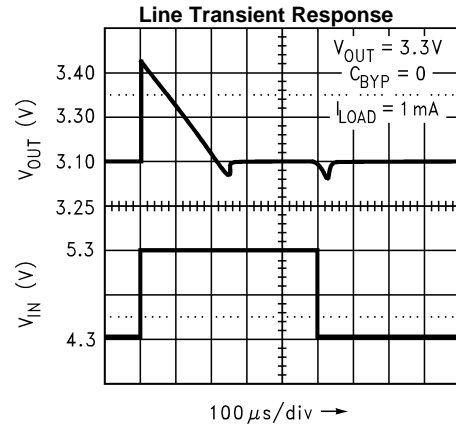

Figure 28.

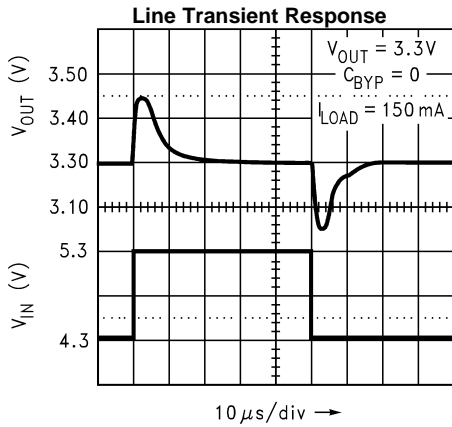

Figure 29.

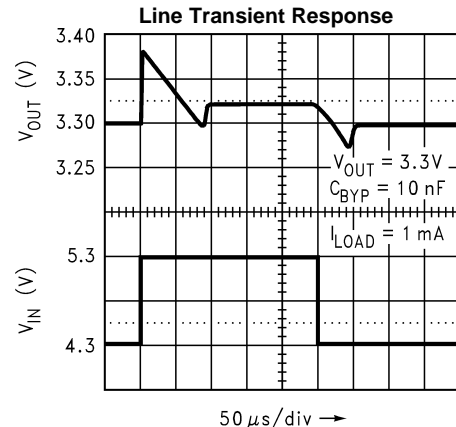

Figure 30.

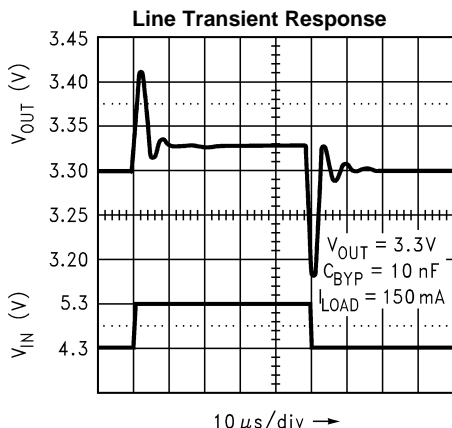

Figure 31.

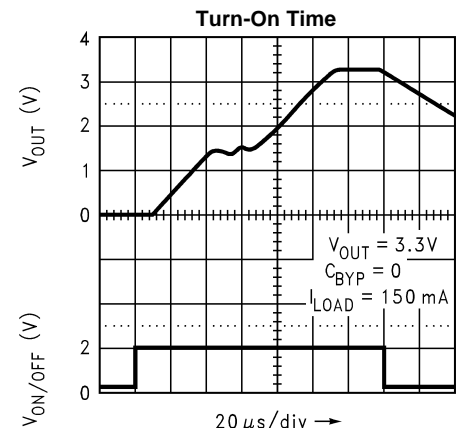
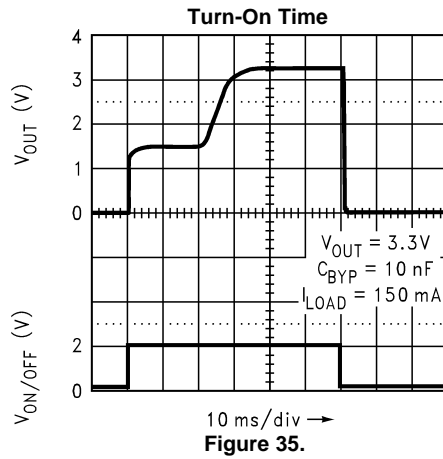
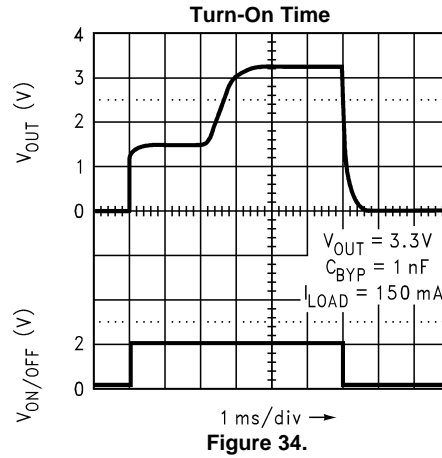
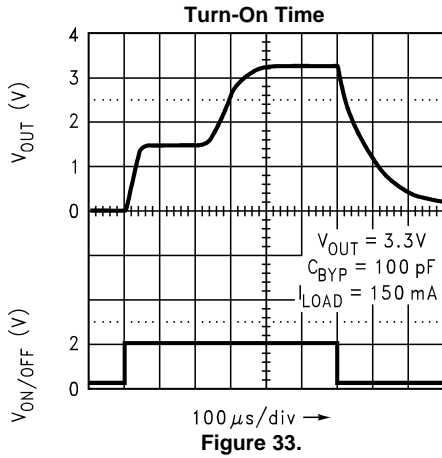

Figure 32.

**Typical Performance Characteristics (continued)**

Unless otherwise specified:  $C_{IN} = 1\mu F$ ,  $C_{OUT} = 4.7\mu F$ ,  $V_{IN} = V_{OUT(NOM)} + 1$ ,  $T_A = 25^\circ C$ , ON/OFF pin is tied to  $V_{IN}$ .



## APPLICATION HINTS

### EXTERNAL CAPACITORS

Like any low-dropout regulator, the LP2992 requires external capacitors for regulator stability. These capacitors must be correctly selected for good performance.

#### Input Capacitor

An input capacitor whose capacitance is  $\geq 1 \mu\text{F}$  is required between the LP2992 input and ground (the amount of capacitance may be increased without limit).

This capacitor must be located a distance of not more than 1 cm from the input pin and returned to a clean analog ground. Any good quality ceramic, tantalum, or film capacitor may be used at the input.

**Important:** Tantalum capacitors can suffer catastrophic failure due to surge current when connected to a low-impedance source of power (like a battery or very large capacitor). If a Tantalum capacitor is used at the input, it must be specified by the manufacturer to have a surge current rating sufficient for the application.

There are no requirements for ESR on the input capacitor, but tolerance and temperature coefficient must be considered when selecting the capacitor to ensure the capacitance will be  $\geq 1 \mu\text{F}$  over the entire operating temperature range.

#### Output Capacitor:

The LP2992 is designed specifically to work with ceramic output capacitors, utilizing circuitry which allows the regulator to be stable across the entire range of output current with an output capacitor whose ESR is as low as 5 m $\Omega$ . It may also be possible to use Tantalum or film capacitors at the output, but these are not as attractive for reasons of size and cost (see next section, [CAPACITOR CHARACTERISTICS](#)).

The output capacitor must meet the requirement for minimum amount of capacitance and also have an ESR (equivalent series resistance) value which is within the stable range. Curves are provided which show the stable ESR range as a function of load current (see ESR graph below).

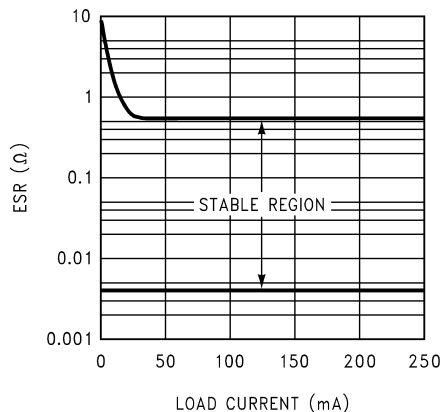

**Important:** The output capacitor must maintain its ESR within the stable region over the full operating temperature range of the application to assure stability.

The LP2992 requires a minimum of 4.7  $\mu\text{F}$  on the output (output capacitor size can be increased without limit).

It is important to remember that capacitor tolerance and variation with temperature must be taken into consideration when selecting an output capacitor so that the minimum required amount of output capacitance is provided over the full operating temperature range. It should be noted that ceramic capacitors can exhibit large changes in capacitance with temperature (see next section, [CAPACITOR CHARACTERISTICS](#)).

The output capacitor must be located not more than 1 cm from the output pin and returned to a clean analog ground.

### Noise Bypass Capacitor:

Connecting a 10 nF capacitor to the Bypass pin significantly reduces noise on the regulator output. It should be noted that the capacitor is connected directly to a high-impedance circuit in the bandgap reference.

Because this circuit has only a few microamperes flowing in it, any significant loading on this node will cause a change in the regulated output voltage. For this reason, DC leakage current through the noise bypass capacitor must never exceed 100 nA, and should be kept as low as possible for best output voltage accuracy.

The types of capacitors best suited for the noise bypass capacitor are ceramic and film. High-quality ceramic capacitors with either NPO or COG dielectric typically have very low leakage. 10 nF polypropylene and polycarbonate film capacitors are available in small surface-mount packages and typically have extremely low leakage current.

## CAPACITOR CHARACTERISTICS

The LP2992 was designed to work with ceramic capacitors on the output to take advantage of the benefits they offer: for capacitance values in the 2.2  $\mu\text{F}$  to 10  $\mu\text{F}$  range, ceramics are the least expensive and also have the lowest ESR values (which makes them best for eliminating high-frequency noise). The ESR of a typical 4.7  $\mu\text{F}$  ceramic capacitor is in the range of 5 m $\Omega$  to 10 m $\Omega$ , which easily meets the ESR limits required for stability by the LP2992.

One disadvantage of ceramic capacitors is that their capacitance can vary with temperature. Most large value ceramic capacitors ( $\geq 2.2 \mu\text{F}$ ) are manufactured with the Z5U or Y5V temperature characteristic, which results in the capacitance dropping by more than 50% as the temperature goes from 25°C to 85°C.

This could cause problems if a 4.7  $\mu\text{F}$  capacitor were used on the output since it will drop down to approximately 2.3  $\mu\text{F}$  at high ambient temperatures (which could cause the LP2992 to oscillate). If Z5U or Y5V capacitors are used on the output, a minimum capacitance value of 10  $\mu\text{F}$  must be observed.

A better choice for temperature coefficient in ceramic capacitors is X7R, which holds the capacitance within  $\pm 15\%$ . Unfortunately, the larger values of capacitance are not offered by all manufacturers in the X7R dielectric.

### Tantalum:

Tantalum capacitors are less desirable than ceramics for use as output capacitors because they are more expensive when comparing equivalent capacitance and voltage ratings in the 1  $\mu\text{F}$  to 4.7  $\mu\text{F}$  range.

Another important consideration is that Tantalum capacitors have higher ESR values than equivalent size ceramics. This means that while it may be possible to find a Tantalum capacitor with an ESR value within the stable range, it would have to be larger in capacitance (which means bigger and more costly) than a ceramic capacitor with the same ESR value.

It should also be noted that the ESR of a typical Tantalum will increase about 2:1 as the temperature goes from 25°C down to -40°C, so some guard band must be allowed.

## ON/OFF INPUT OPERATION

The LP2992 is shut off by driving the ON/OFF input low, and turned on by pulling it high. If this feature is not to be used, the ON/OFF input should be tied to  $V_{\text{IN}}$  to keep the regulator output on at all times.

To assure proper operation, the signal source used to drive the ON/OFF input must be able to swing above and below the specified turn-on/turn-off voltage thresholds listed in the [Electrical Characteristics](#) section under  $V_{\text{ON/OFF}}$ . To prevent mis-operation, the turn-on (and turn-off) voltage signals applied to the ON/OFF input must have a slew rate which is  $\geq 40 \text{ mV}/\mu\text{s}$ .

### CAUTION

The regulator output voltage can not be ensured if a slow-moving AC (or DC) signal is applied that is in the range between the specified turn-on and turn-off voltages listed under the electrical specification  $V_{\text{ON/OFF}}$  (see [Electrical Characteristics](#)).

## REVERSE INPUT-OUTPUT VOLTAGE

The PNP power transistor used as the pass element in the LP2992 has an inherent diode connected between the regulator output and input. During normal operation (where the input voltage is higher than the output) this diode is reverse-biased.

However, if the output is pulled above the input, this diode will turn ON and current will flow into the regulator output. In such cases, a parasitic SCR can latch which will allow a high current to flow into  $V_{IN}$  (and out the ground pin), which can damage the part.

In any application where the output may be pulled above the input, an external Schottky diode must be connected from  $V_{IN}$  to  $V_{OUT}$  (cathode on  $V_{IN}$ , anode on  $V_{OUT}$ ), to limit the reverse voltage across the LP2992 to 0.3V (see [Absolute Maximum Ratings](#)).

## WSON MOUNTING

The WSON package requires specific mounting techniques which are detailed in Application Note # 1187 (literature number [SNOA401](#)). Referring to the section **PCB Design Recommendations**, it should be noted that the pad style which should be used with the WSON package is the NSMD (non-solder mask defined) type.

The thermal dissipation of the WSON package is directly related to the printed circuit board construction and the amount of additional copper area.

For the LP2992 in the NGD0006A 6-Lead WSON package, the junction-to-case thermal rating,  $\theta_{JC}$ , is 19°C/W, where the case is actually the bottom of the package at the center of the DAP. The junction-to-ambient thermal performance for the LP2992 in the NGD0006A 6-Lead WSON package, using the JEDEC standards is summarized in the following table:

Board Type	Thermal Vias	$\theta_{JC}$	$\theta_{JA}$
JEDEC 2-Layer	None	19°C/W	282°C/W
JEDEC 4-Layer	1	19°C/W	94°C/W
	2	19°C/W	78°C/W
	4	19°C/W	66°C/W
	6	19°C/W	62°C/W

## REVISION HISTORY

Changes from Revision F (March 2013) to Revision G	Page
• Changed layout of National Data Sheet to TI format .....	<a href="#">13</a>

**PACKAGING INFORMATION**

Orderable Device	Status (1)	Package Type	Package Drawing	Pins	Package Qty	Eco Plan (2)	Lead/Ball Finish	MSL Peak Temp (3)	Op Temp (°C)	Top-Side Markings (4)	Samples
LP2992AILD-1.5	ACTIVE	WSON	NGD	6	1000	TBD	Call TI	Call TI	-40 to 125	L011A	<a href="#">Samples</a>
LP2992AILD-1.5/NOPB	ACTIVE	WSON	NGD	6	1000	Green (RoHS & no Sb/Br)	CU SN	Level-3-260C-168 HR	-40 to 125	L011A	<a href="#">Samples</a>
LP2992AILD-1.8	ACTIVE	WSON	NGD	6	1000	TBD	Call TI	Call TI	-40 to 125	L012A	<a href="#">Samples</a>
LP2992AILD-1.8/NOPB	ACTIVE	WSON	NGD	6	1000	Green (RoHS & no Sb/Br)	CU SN	Level-3-260C-168 HR	-40 to 125	L012A	<a href="#">Samples</a>
LP2992AILD-3.3	ACTIVE	WSON	NGD	6	1000	TBD	Call TI	Call TI	-40 to 125	L014A	<a href="#">Samples</a>
LP2992AILD-3.3/NOPB	ACTIVE	WSON	NGD	6	1000	Green (RoHS & no Sb/Br)	CU SN	Level-3-260C-168 HR	-40 to 125	L014A	<a href="#">Samples</a>
LP2992AILD-5.0	ACTIVE	WSON	NGD	6	1000	TBD	Call TI	Call TI	-40 to 125	L015A	<a href="#">Samples</a>
LP2992AILD-5.0/NOPB	ACTIVE	WSON	NGD	6	1000	Green (RoHS & no Sb/Br)	CU SN	Level-3-260C-168 HR	-40 to 125	L015A	<a href="#">Samples</a>
LP2992AILD-1.8	ACTIVE	WSON	NGD	6	4500	TBD	Call TI	Call TI	-40 to 125	L012A	<a href="#">Samples</a>
LP2992AILD-1.8/NOPB	ACTIVE	WSON	NGD	6	4500	Green (RoHS & no Sb/Br)	CU SN	Level-3-260C-168 HR	-40 to 125	L012A	<a href="#">Samples</a>
LP2992AILD-3.3	ACTIVE	WSON	NGD	6	4500	TBD	Call TI	Call TI	-40 to 125	L014A	<a href="#">Samples</a>
LP2992AILD-3.3/NOPB	ACTIVE	WSON	NGD	6	4500	Green (RoHS & no Sb/Br)	CU SN	Level-3-260C-168 HR	-40 to 125	L014A	<a href="#">Samples</a>
LP2992AILD-5.0	ACTIVE	WSON	NGD	6	4500	TBD	Call TI	Call TI	-40 to 125	L015A	<a href="#">Samples</a>
LP2992AILD-5.0/NOPB	ACTIVE	WSON	NGD	6	4500	Green (RoHS & no Sb/Br)	CU SN	Level-3-260C-168 HR	-40 to 125	L015A	<a href="#">Samples</a>
LP2992AIM5-1.5	ACTIVE	SOT-23	DBV	5	1000	TBD	Call TI	Call TI	-40 to 125	LFBA	<a href="#">Samples</a>
LP2992AIM5-1.5/NOPB	ACTIVE	SOT-23	DBV	5	1000	Green (RoHS & no Sb/Br)	CU SN	Level-1-260C-UNLIM	-40 to 125	LFBA	<a href="#">Samples</a>
LP2992AIM5-1.8	ACTIVE	SOT-23	DBV	5	1000	TBD	Call TI	Call TI	-40 to 125	LFCA	<a href="#">Samples</a>
LP2992AIM5-1.8/NOPB	ACTIVE	SOT-23	DBV	5	1000	Green (RoHS & no Sb/Br)	CU SN	Level-1-260C-UNLIM	-40 to 125	LFCA	<a href="#">Samples</a>
LP2992AIM5-2.5	ACTIVE	SOT-23	DBV	5	1000	TBD	Call TI	Call TI	-40 to 125	LFDA	<a href="#">Samples</a>

Orderable Device	Status (1)	Package Type	Package Drawing	Pins	Package Qty	Eco Plan (2)	Lead/Ball Finish	MSL Peak Temp (3)	Op Temp (°C)	Top-Side Markings (4)	Samples
LP2992AIM5-2.5/NOPB	ACTIVE	SOT-23	DBV	5	1000	Green (RoHS & no Sb/Br)	CU SN	Level-1-260C-UNLIM	-40 to 125	LFDA	<a href="#">Samples</a>
LP2992AIM5-3.3	ACTIVE	SOT-23	DBV	5	1000	TBD	Call TI	Call TI	-40 to 125	LFEA	<a href="#">Samples</a>
LP2992AIM5-3.3/NOPB	ACTIVE	SOT-23	DBV	5	1000	Green (RoHS & no Sb/Br)	CU SN	Level-1-260C-UNLIM	-40 to 125	LFEA	<a href="#">Samples</a>
LP2992AIM5-5.0	ACTIVE	SOT-23	DBV	5	1000	TBD	Call TI	Call TI	-40 to 125	LFFA	<a href="#">Samples</a>
LP2992AIM5-5.0/NOPB	ACTIVE	SOT-23	DBV	5	1000	Green (RoHS & no Sb/Br)	CU SN	Level-1-260C-UNLIM	-40 to 125	LFFA	<a href="#">Samples</a>
LP2992AIM5X-1.5	ACTIVE	SOT-23	DBV	5	3000	TBD	Call TI	Call TI	-40 to 125	LFBA	<a href="#">Samples</a>
LP2992AIM5X-1.5/NOPB	ACTIVE	SOT-23	DBV	5	3000	Green (RoHS & no Sb/Br)	CU SN	Level-1-260C-UNLIM	-40 to 125	LFBA	<a href="#">Samples</a>
LP2992AIM5X-1.8	ACTIVE	SOT-23	DBV	5	3000	TBD	Call TI	Call TI	-40 to 125	LFCA	<a href="#">Samples</a>
LP2992AIM5X-1.8/NOPB	ACTIVE	SOT-23	DBV	5	3000	Green (RoHS & no Sb/Br)	CU SN	Level-1-260C-UNLIM	-40 to 125	LFCA	<a href="#">Samples</a>
LP2992AIM5X-2.5	ACTIVE	SOT-23	DBV	5	3000	TBD	Call TI	Call TI	-40 to 125	LFDA	<a href="#">Samples</a>
LP2992AIM5X-2.5/NOPB	ACTIVE	SOT-23	DBV	5	3000	Green (RoHS & no Sb/Br)	CU SN	Level-1-260C-UNLIM	-40 to 125	LFDA	<a href="#">Samples</a>
LP2992AIM5X-3.3	ACTIVE	SOT-23	DBV	5	3000	TBD	Call TI	Call TI	-40 to 125	LFEA	<a href="#">Samples</a>
LP2992AIM5X-3.3/NOPB	ACTIVE	SOT-23	DBV	5	3000	Green (RoHS & no Sb/Br)	CU SN	Level-1-260C-UNLIM	-40 to 125	LFEA	<a href="#">Samples</a>
LP2992AIM5X-5.0	ACTIVE	SOT-23	DBV	5	3000	TBD	Call TI	Call TI	-40 to 125	LFFA	<a href="#">Samples</a>
LP2992AIM5X-5.0/NOPB	ACTIVE	SOT-23	DBV	5	3000	Green (RoHS & no Sb/Br)	CU SN	Level-1-260C-UNLIM	-40 to 125	LFFA	<a href="#">Samples</a>
LP2992ILD-1.8	ACTIVE	WSON	NGD	6	1000	TBD	Call TI	Call TI	-40 to 125	L012A B	<a href="#">Samples</a>
LP2992ILD-1.8/NOPB	ACTIVE	WSON	NGD	6	1000	Green (RoHS & no Sb/Br)	CU SN	Level-3-260C-168 HR	-40 to 125	L012A B	<a href="#">Samples</a>
LP2992ILD-2.5	ACTIVE	WSON	NGD	6	1000	TBD	Call TI	Call TI	-40 to 125	L013A B	<a href="#">Samples</a>
LP2992ILD-2.5/NOPB	ACTIVE	WSON	NGD	6	1000	Green (RoHS & no Sb/Br)	CU SN	Level-3-260C-168 HR	-40 to 125	L013A B	<a href="#">Samples</a>



Orderable Device	Status (1)	Package Type	Package Drawing	Pins	Package Qty	Eco Plan (2)	Lead/Ball Finish	MSL Peak Temp (3)	Op Temp (°C)	Top-Side Markings (4)	Samples
LP2992ILD-3.3	ACTIVE	WSON	NGD	6	1000	TBD	Call TI	Call TI	-40 to 125	L014A B	<a href="#">Samples</a>
LP2992ILD-3.3/NOPB	ACTIVE	WSON	NGD	6	1000	Green (RoHS & no Sb/Br)	CU SN	Level-3-260C-168 HR	-40 to 125	L014A B	<a href="#">Samples</a>
LP2992ILD-5.0	ACTIVE	WSON	NGD	6	1000	TBD	Call TI	Call TI	-40 to 125	L015A B	<a href="#">Samples</a>
LP2992ILD-5.0/NOPB	ACTIVE	WSON	NGD	6	1000	Green (RoHS & no Sb/Br)	CU SN	Level-3-260C-168 HR	-40 to 125	L015A B	<a href="#">Samples</a>
LP2992ILD-1.5	ACTIVE	WSON	NGD	6	4500	TBD	Call TI	Call TI	-40 to 125	L011A B	<a href="#">Samples</a>
LP2992ILD-1.5/NOPB	ACTIVE	WSON	NGD	6	4500	Green (RoHS & no Sb/Br)	CU SN	Level-3-260C-168 HR	-40 to 125	L011A B	<a href="#">Samples</a>
LP2992ILD-1.8	ACTIVE	WSON	NGD	6	4500	TBD	Call TI	Call TI	-40 to 125	L012A B	<a href="#">Samples</a>
LP2992ILD-1.8/NOPB	ACTIVE	WSON	NGD	6	4500	Green (RoHS & no Sb/Br)	CU SN	Level-3-260C-168 HR	-40 to 125	L012A B	<a href="#">Samples</a>
LP2992ILD-3.3	ACTIVE	WSON	NGD	6	4500	TBD	Call TI	Call TI	-40 to 125	L014A B	<a href="#">Samples</a>
LP2992ILD-3.3/NOPB	ACTIVE	WSON	NGD	6	4500	Green (RoHS & no Sb/Br)	CU SN	Level-3-260C-168 HR	-40 to 125	L014A B	<a href="#">Samples</a>
LP2992ILD-5.0	ACTIVE	WSON	NGD	6	4500	TBD	Call TI	Call TI	-40 to 125	L015A B	<a href="#">Samples</a>
LP2992ILD-5.0/NOPB	ACTIVE	WSON	NGD	6	4500	Green (RoHS & no Sb/Br)	CU SN	Level-3-260C-168 HR	-40 to 125	L015A B	<a href="#">Samples</a>
LP2992IM5-1.5	ACTIVE	SOT-23	DBV	5	1000	TBD	Call TI	Call TI	-40 to 125	LFBB	<a href="#">Samples</a>
LP2992IM5-1.5/NOPB	ACTIVE	SOT-23	DBV	5	1000	Green (RoHS & no Sb/Br)	CU SN	Level-1-260C-UNLIM	-40 to 125	LFBB	<a href="#">Samples</a>
LP2992IM5-1.8	ACTIVE	SOT-23	DBV	5	1000	TBD	Call TI	Call TI	-40 to 125	LFBB	<a href="#">Samples</a>
LP2992IM5-1.8/NOPB	ACTIVE	SOT-23	DBV	5	1000	Green (RoHS & no Sb/Br)	CU SN	Level-1-260C-UNLIM	-40 to 125	LFBB	<a href="#">Samples</a>
LP2992IM5-2.5	ACTIVE	SOT-23	DBV	5	1000	TBD	Call TI	Call TI	-40 to 125	LFDB	<a href="#">Samples</a>
LP2992IM5-2.5/NOPB	ACTIVE	SOT-23	DBV	5	1000	Green (RoHS & no Sb/Br)	CU SN	Level-1-260C-UNLIM	-40 to 125	LFDB	<a href="#">Samples</a>

Orderable Device	Status (1)	Package Type	Package Drawing	Pins	Package Qty	Eco Plan (2)	Lead/Ball Finish	MSL Peak Temp (3)	Op Temp (°C)	Top-Side Markings (4)	Samples
LP2992IM5-3.0	ACTIVE	SOT-23	DBV	5	1000	TBD	Call TI	Call TI		LF8B	<a href="#">Samples</a>
LP2992IM5-3.0/NOPB	ACTIVE	SOT-23	DBV	5	1000	Green (RoHS & no Sb/Br)	CU SN	Level-1-260C-UNLIM		LF8B	<a href="#">Samples</a>
LP2992IM5-3.3	ACTIVE	SOT-23	DBV	5	1000	TBD	Call TI	Call TI	-40 to 125	LFEB	<a href="#">Samples</a>
LP2992IM5-3.3/NOPB	ACTIVE	SOT-23	DBV	5	1000	Green (RoHS & no Sb/Br)	CU SN	Level-1-260C-UNLIM	-40 to 125	LFEB	<a href="#">Samples</a>
LP2992IM5-5.0	ACTIVE	SOT-23	DBV	5	1000	TBD	Call TI	Call TI	-40 to 125	LFFB	<a href="#">Samples</a>
LP2992IM5-5.0/NOPB	ACTIVE	SOT-23	DBV	5	1000	Green (RoHS & no Sb/Br)	CU SN	Level-1-260C-UNLIM	-40 to 125	LFFB	<a href="#">Samples</a>
LP2992IM5X-1.5	ACTIVE	SOT-23	DBV	5	3000	TBD	Call TI	Call TI	-40 to 125	LFBB	<a href="#">Samples</a>
LP2992IM5X-1.5/NOPB	ACTIVE	SOT-23	DBV	5	3000	Green (RoHS & no Sb/Br)	CU SN	Level-1-260C-UNLIM	-40 to 125	LFBB	<a href="#">Samples</a>
LP2992IM5X-1.8	ACTIVE	SOT-23	DBV	5	3000	TBD	Call TI	Call TI	-40 to 125	LFCB	<a href="#">Samples</a>
LP2992IM5X-1.8/NOPB	ACTIVE	SOT-23	DBV	5	3000	Green (RoHS & no Sb/Br)	CU SN	Level-1-260C-UNLIM	-40 to 125	LFCB	<a href="#">Samples</a>
LP2992IM5X-2.5	ACTIVE	SOT-23	DBV	5	3000	TBD	Call TI	Call TI	-40 to 125	LFDB	<a href="#">Samples</a>
LP2992IM5X-2.5/NOPB	ACTIVE	SOT-23	DBV	5	3000	Green (RoHS & no Sb/Br)	CU SN	Level-1-260C-UNLIM	-40 to 125	LFDB	<a href="#">Samples</a>
LP2992IM5X-3.3	ACTIVE	SOT-23	DBV	5	3000	TBD	Call TI	Call TI	-40 to 125	LFEB	<a href="#">Samples</a>
LP2992IM5X-3.3/NOPB	ACTIVE	SOT-23	DBV	5	3000	Green (RoHS & no Sb/Br)	CU SN	Level-1-260C-UNLIM	-40 to 125	LFEB	<a href="#">Samples</a>
LP2992IM5X-5.0	ACTIVE	SOT-23	DBV	5	3000	TBD	Call TI	Call TI	-40 to 125	LFFB	<a href="#">Samples</a>
LP2992IM5X-5.0/NOPB	ACTIVE	SOT-23	DBV	5	3000	Green (RoHS & no Sb/Br)	CU SN	Level-1-260C-UNLIM	-40 to 125	LFFB	<a href="#">Samples</a>

(1) The marketing status values are defined as follows:

**ACTIVE:** Product device recommended for new designs.

**LIFEBUY:** TI has announced that the device will be discontinued, and a lifetime-buy period is in effect.

**NRND:** Not recommended for new designs. Device is in production to support existing customers, but TI does not recommend using this part in a new design.

**PREVIEW:** Device has been announced but is not in production. Samples may or may not be available.

**OBSELETE:** TI has discontinued the production of the device.

---

(2) Eco Plan - The planned eco-friendly classification: Pb-Free (RoHS), Pb-Free (RoHS Exempt), or Green (RoHS & no Sb/Br) - please check <http://www.ti.com/productcontent> for the latest availability information and additional product content details.

**TBD:** The Pb-Free/Green conversion plan has not been defined.

**Pb-Free (RoHS):** TI's terms "Lead-Free" or "Pb-Free" mean semiconductor products that are compatible with the current RoHS requirements for all 6 substances, including the requirement that lead not exceed 0.1% by weight in homogeneous materials. Where designed to be soldered at high temperatures, TI Pb-Free products are suitable for use in specified lead-free processes.

**Pb-Free (RoHS Exempt):** This component has a RoHS exemption for either 1) lead-based flip-chip solder bumps used between the die and package, or 2) lead-based die adhesive used between the die and leadframe. The component is otherwise considered Pb-Free (RoHS compatible) as defined above.

**Green (RoHS & no Sb/Br):** TI defines "Green" to mean Pb-Free (RoHS compatible), and free of Bromine (Br) and Antimony (Sb) based flame retardants (Br or Sb do not exceed 0.1% by weight in homogeneous material)

(3) MSL, Peak Temp. -- The Moisture Sensitivity Level rating according to the JEDEC industry standard classifications, and peak solder temperature.

(4) Multiple Top-Side Markings will be inside parentheses. Only one Top-Side Marking contained in parentheses and separated by a "~" will appear on a device. If a line is indented then it is a continuation of the previous line and the two combined represent the entire Top-Side Marking for that device.

**Important Information and Disclaimer:** The information provided on this page represents TI's knowledge and belief as of the date that it is provided. TI bases its knowledge and belief on information provided by third parties, and makes no representation or warranty as to the accuracy of such information. Efforts are underway to better integrate information from third parties. TI has taken and continues to take reasonable steps to provide representative and accurate information but may not have conducted destructive testing or chemical analysis on incoming materials and chemicals. TI and TI suppliers consider certain information to be proprietary, and thus CAS numbers and other limited information may not be available for release.

In no event shall TI's liability arising out of such information exceed the total purchase price of the TI part(s) at issue in this document sold by TI to Customer on an annual basis.

## TAPE AND REEL INFORMATION



### QUADRANT ASSIGNMENTS FOR PIN 1 ORIENTATION IN TAPE



\*All dimensions are nominal

Device	Package Type	Package Drawing	Pins	SPQ	Reel Diameter (mm)	Reel Width W1 (mm)	A0 (mm)	B0 (mm)	K0 (mm)	P1 (mm)	W (mm)	Pin1 Quadrant
LP2992AILD-1.5	WSO	NGD	6	1000	178.0	12.4	3.6	3.2	1.0	8.0	12.0	Q1
LP2992AILD-1.5/NOPB	WSO	NGD	6	1000	178.0	12.4	3.6	3.2	1.0	8.0	12.0	Q1
LP2992AILD-1.8	WSO	NGD	6	1000	178.0	12.4	3.6	3.2	1.0	8.0	12.0	Q1
LP2992AILD-1.8/NOPB	WSO	NGD	6	1000	178.0	12.4	3.6	3.2	1.0	8.0	12.0	Q1
LP2992AILD-3.3	WSO	NGD	6	1000	178.0	12.4	3.6	3.2	1.0	8.0	12.0	Q1
LP2992AILD-3.3/NOPB	WSO	NGD	6	1000	178.0	12.4	3.6	3.2	1.0	8.0	12.0	Q1
LP2992AILD-5.0	WSO	NGD	6	1000	178.0	12.4	3.6	3.2	1.0	8.0	12.0	Q1
LP2992AILD-5.0/NOPB	WSO	NGD	6	1000	178.0	12.4	3.6	3.2	1.0	8.0	12.0	Q1
LP2992AILD-1.8	WSO	NGD	6	4500	330.0	12.4	3.6	3.2	1.0	8.0	12.0	Q1
LP2992AILD-1.8/NOPB	WSO	NGD	6	4500	330.0	12.4	3.6	3.2	1.0	8.0	12.0	Q1
LP2992AILD-3.3	WSO	NGD	6	4500	330.0	12.4	3.6	3.2	1.0	8.0	12.0	Q1
LP2992AILD-3.3/NOPB	WSO	NGD	6	4500	330.0	12.4	3.6	3.2	1.0	8.0	12.0	Q1
LP2992AILD-5.0	WSO	NGD	6	4500	330.0	12.4	3.6	3.2	1.0	8.0	12.0	Q1
LP2992AILD-5.0/NOPB	WSO	NGD	6	4500	330.0	12.4	3.6	3.2	1.0	8.0	12.0	Q1
LP2992AIM5-1.5	SOT-23	DBV	5	1000	178.0	8.4	3.2	3.2	1.4	4.0	8.0	Q3
LP2992AIM5-1.5/NOPB	SOT-23	DBV	5	1000	178.0	8.4	3.2	3.2	1.4	4.0	8.0	Q3
LP2992AIM5-1.8	SOT-23	DBV	5	1000	178.0	8.4	3.2	3.2	1.4	4.0	8.0	Q3
LP2992AIM5-1.8/NOPB	SOT-23	DBV	5	1000	178.0	8.4	3.2	3.2	1.4	4.0	8.0	Q3

Device	Package Type	Package Drawing	Pins	SPQ	Reel Diameter (mm)	Reel Width W1 (mm)	A0 (mm)	B0 (mm)	K0 (mm)	P1 (mm)	W (mm)	Pin1 Quadrant
LP2992AIM5-2.5	SOT-23	DBV	5	1000	178.0	8.4	3.2	3.2	1.4	4.0	8.0	Q3
LP2992AIM5-2.5/NOPB	SOT-23	DBV	5	1000	178.0	8.4	3.2	3.2	1.4	4.0	8.0	Q3
LP2992AIM5-3.3	SOT-23	DBV	5	1000	178.0	8.4	3.2	3.2	1.4	4.0	8.0	Q3
LP2992AIM5-3.3/NOPB	SOT-23	DBV	5	1000	178.0	8.4	3.2	3.2	1.4	4.0	8.0	Q3
LP2992AIM5-5.0	SOT-23	DBV	5	1000	178.0	8.4	3.2	3.2	1.4	4.0	8.0	Q3
LP2992AIM5-5.0/NOPB	SOT-23	DBV	5	1000	178.0	8.4	3.2	3.2	1.4	4.0	8.0	Q3
LP2992AIM5X-1.5	SOT-23	DBV	5	3000	178.0	8.4	3.2	3.2	1.4	4.0	8.0	Q3
LP2992AIM5X-1.5/NOPB	SOT-23	DBV	5	3000	178.0	8.4	3.2	3.2	1.4	4.0	8.0	Q3
LP2992AIM5X-1.8	SOT-23	DBV	5	3000	178.0	8.4	3.2	3.2	1.4	4.0	8.0	Q3
LP2992AIM5X-1.8/NOPB	SOT-23	DBV	5	3000	178.0	8.4	3.2	3.2	1.4	4.0	8.0	Q3
LP2992AIM5X-2.5	SOT-23	DBV	5	3000	178.0	8.4	3.2	3.2	1.4	4.0	8.0	Q3
LP2992AIM5X-2.5/NOPB	SOT-23	DBV	5	3000	178.0	8.4	3.2	3.2	1.4	4.0	8.0	Q3
LP2992AIM5X-3.3	SOT-23	DBV	5	3000	178.0	8.4	3.2	3.2	1.4	4.0	8.0	Q3
LP2992AIM5X-3.3/NOPB	SOT-23	DBV	5	3000	178.0	8.4	3.2	3.2	1.4	4.0	8.0	Q3
LP2992AIM5X-5.0	SOT-23	DBV	5	3000	178.0	8.4	3.2	3.2	1.4	4.0	8.0	Q3
LP2992AIM5X-5.0/NOPB	SOT-23	DBV	5	3000	178.0	8.4	3.2	3.2	1.4	4.0	8.0	Q3
LP2992ILD-1.8	WSO	NGD	6	1000	178.0	12.4	3.6	3.2	1.0	8.0	12.0	Q1
LP2992ILD-1.8/NOPB	WSO	NGD	6	1000	178.0	12.4	3.6	3.2	1.0	8.0	12.0	Q1
LP2992ILD-2.5	WSO	NGD	6	1000	178.0	12.4	3.6	3.2	1.0	8.0	12.0	Q1
LP2992ILD-2.5/NOPB	WSO	NGD	6	1000	178.0	12.4	3.6	3.2	1.0	8.0	12.0	Q1
LP2992ILD-3.3	WSO	NGD	6	1000	178.0	12.4	3.6	3.2	1.0	8.0	12.0	Q1
LP2992ILD-3.3/NOPB	WSO	NGD	6	1000	178.0	12.4	3.6	3.2	1.0	8.0	12.0	Q1
LP2992ILD-5.0	WSO	NGD	6	1000	178.0	12.4	3.6	3.2	1.0	8.0	12.0	Q1
LP2992ILD-5.0/NOPB	WSO	NGD	6	1000	178.0	12.4	3.6	3.2	1.0	8.0	12.0	Q1
LP2992ILD-1.5	WSO	NGD	6	4500	330.0	12.4	3.6	3.2	1.0	8.0	12.0	Q1
LP2992ILD-1.5/NOPB	WSO	NGD	6	4500	330.0	12.4	3.6	3.2	1.0	8.0	12.0	Q1
LP2992ILD-1.8	WSO	NGD	6	4500	330.0	12.4	3.6	3.2	1.0	8.0	12.0	Q1
LP2992ILD-1.8/NOPB	WSO	NGD	6	4500	330.0	12.4	3.6	3.2	1.0	8.0	12.0	Q1
LP2992ILD-3.3	WSO	NGD	6	4500	330.0	12.4	3.6	3.2	1.0	8.0	12.0	Q1
LP2992ILD-3.3/NOPB	WSO	NGD	6	4500	330.0	12.4	3.6	3.2	1.0	8.0	12.0	Q1
LP2992ILD-5.0	WSO	NGD	6	4500	330.0	12.4	3.6	3.2	1.0	8.0	12.0	Q1
LP2992ILD-5.0/NOPB	WSO	NGD	6	4500	330.0	12.4	3.6	3.2	1.0	8.0	12.0	Q1
LP2992IM5-1.5	SOT-23	DBV	5	1000	178.0	8.4	3.2	3.2	1.4	4.0	8.0	Q3
LP2992IM5-1.5/NOPB	SOT-23	DBV	5	1000	178.0	8.4	3.2	3.2	1.4	4.0	8.0	Q3
LP2992IM5-1.8	SOT-23	DBV	5	1000	178.0	8.4	3.2	3.2	1.4	4.0	8.0	Q3
LP2992IM5-1.8/NOPB	SOT-23	DBV	5	1000	178.0	8.4	3.2	3.2	1.4	4.0	8.0	Q3
LP2992IM5-2.5	SOT-23	DBV	5	1000	178.0	8.4	3.2	3.2	1.4	4.0	8.0	Q3
LP2992IM5-2.5/NOPB	SOT-23	DBV	5	1000	178.0	8.4	3.2	3.2	1.4	4.0	8.0	Q3
LP2992IM5-3.0	SOT-23	DBV	5	1000	178.0	8.4	3.2	3.2	1.4	4.0	8.0	Q3
LP2992IM5-3.0/NOPB	SOT-23	DBV	5	1000	178.0	8.4	3.2	3.2	1.4	4.0	8.0	Q3
LP2992IM5-3.3	SOT-23	DBV	5	1000	178.0	8.4	3.2	3.2	1.4	4.0	8.0	Q3
LP2992IM5-3.3/NOPB	SOT-23	DBV	5	1000	178.0	8.4	3.2	3.2	1.4	4.0	8.0	Q3
LP2992IM5-5.0	SOT-23	DBV	5	1000	178.0	8.4	3.2	3.2	1.4	4.0	8.0	Q3

Device	Package Type	Package Drawing	Pins	SPQ	Reel Diameter (mm)	Reel Width W1 (mm)	A0 (mm)	B0 (mm)	K0 (mm)	P1 (mm)	W (mm)	Pin1 Quadrant
LP2992IM5-5.0/NOPB	SOT-23	DBV	5	1000	178.0	8.4	3.2	3.2	1.4	4.0	8.0	Q3
LP2992IM5X-1.5	SOT-23	DBV	5	3000	178.0	8.4	3.2	3.2	1.4	4.0	8.0	Q3
LP2992IM5X-1.5/NOPB	SOT-23	DBV	5	3000	178.0	8.4	3.2	3.2	1.4	4.0	8.0	Q3
LP2992IM5X-1.8	SOT-23	DBV	5	3000	178.0	8.4	3.2	3.2	1.4	4.0	8.0	Q3
LP2992IM5X-1.8/NOPB	SOT-23	DBV	5	3000	178.0	8.4	3.2	3.2	1.4	4.0	8.0	Q3
LP2992IM5X-2.5	SOT-23	DBV	5	3000	178.0	8.4	3.2	3.2	1.4	4.0	8.0	Q3
LP2992IM5X-2.5/NOPB	SOT-23	DBV	5	3000	178.0	8.4	3.2	3.2	1.4	4.0	8.0	Q3
LP2992IM5X-3.3	SOT-23	DBV	5	3000	178.0	8.4	3.2	3.2	1.4	4.0	8.0	Q3
LP2992IM5X-3.3/NOPB	SOT-23	DBV	5	3000	178.0	8.4	3.2	3.2	1.4	4.0	8.0	Q3
LP2992IM5X-5.0	SOT-23	DBV	5	3000	178.0	8.4	3.2	3.2	1.4	4.0	8.0	Q3
LP2992IM5X-5.0/NOPB	SOT-23	DBV	5	3000	178.0	8.4	3.2	3.2	1.4	4.0	8.0	Q3

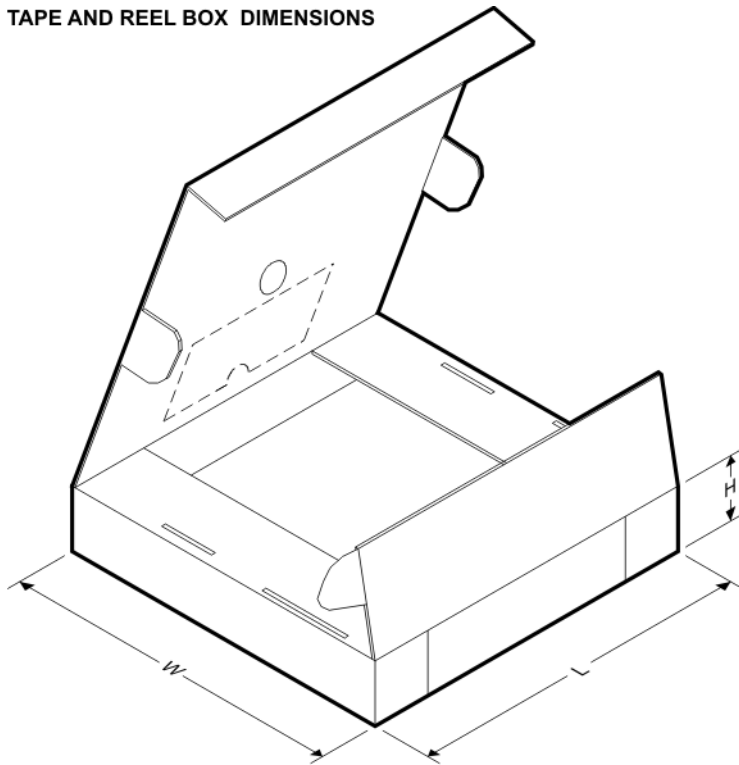
**TAPE AND REEL BOX DIMENSIONS**

\*All dimensions are nominal

Device	Package Type	Package Drawing	Pins	SPQ	Length (mm)	Width (mm)	Height (mm)
LP2992AILD-1.5	WSON	NGD	6	1000	210.0	185.0	35.0
LP2992AILD-1.5/NOPB	WSON	NGD	6	1000	213.0	191.0	55.0
LP2992AILD-1.8	WSON	NGD	6	1000	210.0	185.0	35.0
LP2992AILD-1.8/NOPB	WSON	NGD	6	1000	213.0	191.0	55.0
LP2992AILD-3.3	WSON	NGD	6	1000	210.0	185.0	35.0
LP2992AILD-3.3/NOPB	WSON	NGD	6	1000	213.0	191.0	55.0

Device	Package Type	Package Drawing	Pins	SPQ	Length (mm)	Width (mm)	Height (mm)
LP2992AILD-5.0	WSON	NGD	6	1000	210.0	185.0	35.0
LP2992AILD-5.0/NOPB	WSON	NGD	6	1000	213.0	191.0	55.0
LP2992AILDX-1.8	WSON	NGD	6	4500	367.0	367.0	35.0
LP2992AILDX-1.8/NOPB	WSON	NGD	6	4500	367.0	367.0	35.0
LP2992AILDX-3.3	WSON	NGD	6	4500	367.0	367.0	35.0
LP2992AILDX-3.3/NOPB	WSON	NGD	6	4500	367.0	367.0	35.0
LP2992AILDX-5.0	WSON	NGD	6	4500	367.0	367.0	35.0
LP2992AILDX-5.0/NOPB	WSON	NGD	6	4500	367.0	367.0	35.0
LP2992AIM5-1.5	SOT-23	DBV	5	1000	210.0	185.0	35.0
LP2992AIM5-1.5/NOPB	SOT-23	DBV	5	1000	210.0	185.0	35.0
LP2992AIM5-1.8	SOT-23	DBV	5	1000	210.0	185.0	35.0
LP2992AIM5-1.8/NOPB	SOT-23	DBV	5	1000	210.0	185.0	35.0
LP2992AIM5-2.5	SOT-23	DBV	5	1000	210.0	185.0	35.0
LP2992AIM5-2.5/NOPB	SOT-23	DBV	5	1000	210.0	185.0	35.0
LP2992AIM5-3.3	SOT-23	DBV	5	1000	210.0	185.0	35.0
LP2992AIM5-3.3/NOPB	SOT-23	DBV	5	1000	210.0	185.0	35.0
LP2992AIM5-5.0	SOT-23	DBV	5	1000	210.0	185.0	35.0
LP2992AIM5-5.0/NOPB	SOT-23	DBV	5	1000	210.0	185.0	35.0
LP2992AIM5X-1.5	SOT-23	DBV	5	3000	210.0	185.0	35.0
LP2992AIM5X-1.5/NOPB	SOT-23	DBV	5	3000	210.0	185.0	35.0
LP2992AIM5X-1.8	SOT-23	DBV	5	3000	210.0	185.0	35.0
LP2992AIM5X-1.8/NOPB	SOT-23	DBV	5	3000	210.0	185.0	35.0
LP2992AIM5X-2.5	SOT-23	DBV	5	3000	210.0	185.0	35.0
LP2992AIM5X-2.5/NOPB	SOT-23	DBV	5	3000	210.0	185.0	35.0
LP2992AIM5X-3.3	SOT-23	DBV	5	3000	210.0	185.0	35.0
LP2992AIM5X-3.3/NOPB	SOT-23	DBV	5	3000	210.0	185.0	35.0
LP2992AIM5X-5.0	SOT-23	DBV	5	3000	210.0	185.0	35.0
LP2992AIM5X-5.0/NOPB	SOT-23	DBV	5	3000	210.0	185.0	35.0
LP2992ILD-1.8	WSON	NGD	6	1000	210.0	185.0	35.0
LP2992ILD-1.8/NOPB	WSON	NGD	6	1000	213.0	191.0	55.0
LP2992ILD-2.5	WSON	NGD	6	1000	210.0	185.0	35.0
LP2992ILD-2.5/NOPB	WSON	NGD	6	1000	213.0	191.0	55.0
LP2992ILD-3.3	WSON	NGD	6	1000	210.0	185.0	35.0
LP2992ILD-3.3/NOPB	WSON	NGD	6	1000	213.0	191.0	55.0
LP2992ILD-5.0	WSON	NGD	6	1000	210.0	185.0	35.0
LP2992ILD-5.0/NOPB	WSON	NGD	6	1000	213.0	191.0	55.0
LP2992ILD-1.5	WSON	NGD	6	4500	367.0	367.0	35.0
LP2992ILD-1.5/NOPB	WSON	NGD	6	4500	367.0	367.0	35.0
LP2992ILD-1.8	WSON	NGD	6	4500	367.0	367.0	35.0
LP2992ILD-1.8/NOPB	WSON	NGD	6	4500	367.0	367.0	35.0
LP2992ILD-3.3	WSON	NGD	6	4500	367.0	367.0	35.0
LP2992ILD-3.3/NOPB	WSON	NGD	6	4500	367.0	367.0	35.0
LP2992ILD-5.0	WSON	NGD	6	4500	367.0	367.0	35.0
LP2992ILD-5.0/NOPB	WSON	NGD	6	4500	367.0	367.0	35.0

Device	Package Type	Package Drawing	Pins	SPQ	Length (mm)	Width (mm)	Height (mm)
LP2992IM5-1.5	SOT-23	DBV	5	1000	210.0	185.0	35.0
LP2992IM5-1.5/NOPB	SOT-23	DBV	5	1000	210.0	185.0	35.0
LP2992IM5-1.8	SOT-23	DBV	5	1000	210.0	185.0	35.0
LP2992IM5-1.8/NOPB	SOT-23	DBV	5	1000	210.0	185.0	35.0
LP2992IM5-2.5	SOT-23	DBV	5	1000	210.0	185.0	35.0
LP2992IM5-2.5/NOPB	SOT-23	DBV	5	1000	210.0	185.0	35.0
LP2992IM5-3.0	SOT-23	DBV	5	1000	210.0	185.0	35.0
LP2992IM5-3.0/NOPB	SOT-23	DBV	5	1000	210.0	185.0	35.0
LP2992IM5-3.3	SOT-23	DBV	5	1000	210.0	185.0	35.0
LP2992IM5-3.3/NOPB	SOT-23	DBV	5	1000	210.0	185.0	35.0
LP2992IM5-5.0	SOT-23	DBV	5	1000	210.0	185.0	35.0
LP2992IM5-5.0/NOPB	SOT-23	DBV	5	1000	210.0	185.0	35.0
LP2992IM5X-1.5	SOT-23	DBV	5	3000	210.0	185.0	35.0
LP2992IM5X-1.5/NOPB	SOT-23	DBV	5	3000	210.0	185.0	35.0
LP2992IM5X-1.8	SOT-23	DBV	5	3000	210.0	185.0	35.0
LP2992IM5X-1.8/NOPB	SOT-23	DBV	5	3000	210.0	185.0	35.0
LP2992IM5X-2.5	SOT-23	DBV	5	3000	210.0	185.0	35.0
LP2992IM5X-2.5/NOPB	SOT-23	DBV	5	3000	210.0	185.0	35.0
LP2992IM5X-3.3	SOT-23	DBV	5	3000	210.0	185.0	35.0
LP2992IM5X-3.3/NOPB	SOT-23	DBV	5	3000	210.0	185.0	35.0
LP2992IM5X-5.0	SOT-23	DBV	5	3000	210.0	185.0	35.0
LP2992IM5X-5.0/NOPB	SOT-23	DBV	5	3000	210.0	185.0	35.0



DBV (R-PDSO-G5)

PLASTIC SMALL-OUTLINE PACKAGE



- NOTES:
- A. All linear dimensions are in millimeters.
  - B. This drawing is subject to change without notice.
  - C. Body dimensions do not include mold flash or protrusion. Mold flash and protrusion shall not exceed 0.15 per side.
  - D. Falls within JEDEC MO-178 Variation AA.

DBV (R-PDSO-G5)

PLASTIC SMALL OUTLINE



- NOTES:
- A. All linear dimensions are in millimeters.
  - B. This drawing is subject to change without notice.
  - C. Customers should place a note on the circuit board fabrication drawing not to alter the center solder mask defined pad.
  - D. Publication IPC-7351 is recommended for alternate designs.
  - E. Laser cutting apertures with trapezoidal walls and also rounding corners will offer better paste release. Customers should contact their board assembly site for stencil design recommendations. Example stencil design based on a 50% volumetric metal load solder paste. Refer to IPC-7525 for other stencil recommendations.

NGD0006A

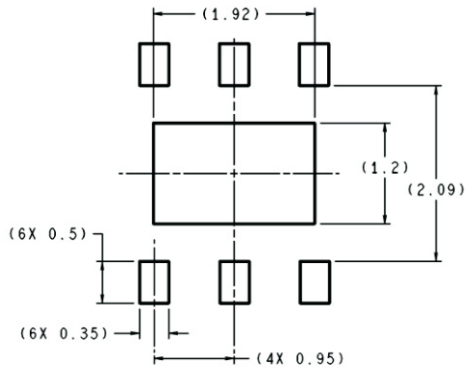

RECOMMENDED LAND PATTERN  
1:1 RATIO WITH PKG SOLDER PADS

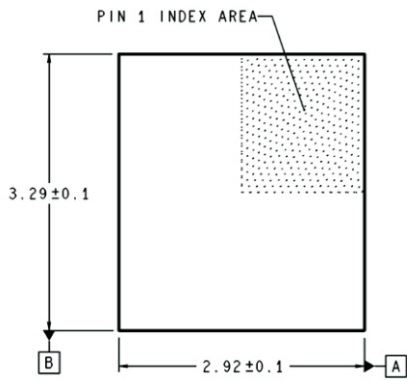

DIMENSIONS ARE IN MILLIMETERS

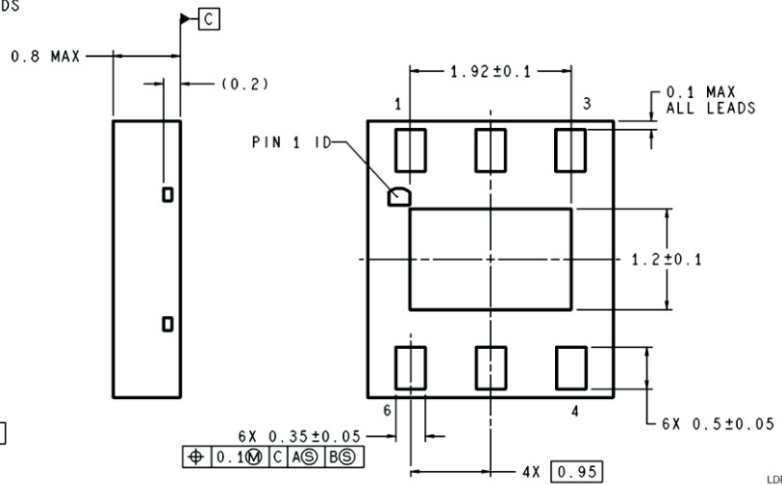

LDE06A (Rev A)

## IMPORTANT NOTICE

Texas Instruments Incorporated and its subsidiaries (TI) reserve the right to make corrections, enhancements, improvements and other changes to its semiconductor products and services per JESD46, latest issue, and to discontinue any product or service per JESD48, latest issue. Buyers should obtain the latest relevant information before placing orders and should verify that such information is current and complete. All semiconductor products (also referred to herein as "components") are sold subject to TI's terms and conditions of sale supplied at the time of order acknowledgment.

TI warrants performance of its components to the specifications applicable at the time of sale, in accordance with the warranty in TI's terms and conditions of sale of semiconductor products. Testing and other quality control techniques are used to the extent TI deems necessary to support this warranty. Except where mandated by applicable law, testing of all parameters of each component is not necessarily performed.

TI assumes no liability for applications assistance or the design of Buyers' products. Buyers are responsible for their products and applications using TI components. To minimize the risks associated with Buyers' products and applications, Buyers should provide adequate design and operating safeguards.

TI does not warrant or represent that any license, either express or implied, is granted under any patent right, copyright, mask work right, or other intellectual property right relating to any combination, machine, or process in which TI components or services are used. Information published by TI regarding third-party products or services does not constitute a license to use such products or services or a warranty or endorsement thereof. Use of such information may require a license from a third party under the patents or other intellectual property of the third party, or a license from TI under the patents or other intellectual property of TI.

Reproduction of significant portions of TI information in TI data books or data sheets is permissible only if reproduction is without alteration and is accompanied by all associated warranties, conditions, limitations, and notices. TI is not responsible or liable for such altered documentation. Information of third parties may be subject to additional restrictions.

Resale of TI components or services with statements different from or beyond the parameters stated by TI for that component or service voids all express and any implied warranties for the associated TI component or service and is an unfair and deceptive business practice. TI is not responsible or liable for any such statements.

Buyer acknowledges and agrees that it is solely responsible for compliance with all legal, regulatory and safety-related requirements concerning its products, and any use of TI components in its applications, notwithstanding any applications-related information or support that may be provided by TI. Buyer represents and agrees that it has all the necessary expertise to create and implement safeguards which anticipate dangerous consequences of failures, monitor failures and their consequences, lessen the likelihood of failures that might cause harm and take appropriate remedial actions. Buyer will fully indemnify TI and its representatives against any damages arising out of the use of any TI components in safety-critical applications.

In some cases, TI components may be promoted specifically to facilitate safety-related applications. With such components, TI's goal is to help enable customers to design and create their own end-product solutions that meet applicable functional safety standards and requirements. Nonetheless, such components are subject to these terms.

No TI components are authorized for use in FDA Class III (or similar life-critical medical equipment) unless authorized officers of the parties have executed a special agreement specifically governing such use.

Only those TI components which TI has specifically designated as military grade or "enhanced plastic" are designed and intended for use in military/aerospace applications or environments. Buyer acknowledges and agrees that any military or aerospace use of TI components which have **not** been so designated is solely at the Buyer's risk, and that Buyer is solely responsible for compliance with all legal and regulatory requirements in connection with such use.

TI has specifically designated certain components as meeting ISO/TS16949 requirements, mainly for automotive use. In any case of use of non-designated products, TI will not be responsible for any failure to meet ISO/TS16949.

### Products

Audio	<a href="http://www.ti.com/audio">www.ti.com/audio</a>
Amplifiers	<a href="http://amplifier.ti.com">amplifier.ti.com</a>
Data Converters	<a href="http://dataconverter.ti.com">dataconverter.ti.com</a>
DLP® Products	<a href="http://www.dlp.com">www.dlp.com</a>
DSP	<a href="http://dsp.ti.com">dsp.ti.com</a>
Clocks and Timers	<a href="http://www.ti.com/clocks">www.ti.com/clocks</a>
Interface	<a href="http://interface.ti.com">interface.ti.com</a>
Logic	<a href="http://logic.ti.com">logic.ti.com</a>
Power Mgmt	<a href="http://power.ti.com">power.ti.com</a>
Microcontrollers	<a href="http://microcontroller.ti.com">microcontroller.ti.com</a>
RFID	<a href="http://www.ti-rfid.com">www.ti-rfid.com</a>
OMAP Applications Processors	<a href="http://www.ti.com/omap">www.ti.com/omap</a>
Wireless Connectivity	<a href="http://www.ti.com/wirelessconnectivity">www.ti.com/wirelessconnectivity</a>

### Applications

Automotive and Transportation	<a href="http://www.ti.com/automotive">www.ti.com/automotive</a>
Communications and Telecom	<a href="http://www.ti.com/communications">www.ti.com/communications</a>
Computers and Peripherals	<a href="http://www.ti.com/computers">www.ti.com/computers</a>
Consumer Electronics	<a href="http://www.ti.com/consumer-apps">www.ti.com/consumer-apps</a>
Energy and Lighting	<a href="http://www.ti.com/energy">www.ti.com/energy</a>
Industrial	<a href="http://www.ti.com/industrial">www.ti.com/industrial</a>
Medical	<a href="http://www.ti.com/medical">www.ti.com/medical</a>
Security	<a href="http://www.ti.com/security">www.ti.com/security</a>
Space, Avionics and Defense	<a href="http://www.ti.com/space-avionics-defense">www.ti.com/space-avionics-defense</a>
Video and Imaging	<a href="http://www.ti.com/video">www.ti.com/video</a>

### TI E2E Community

[e2e.ti.com](http://e2e.ti.com)