

# LP3988 Micropower, 150mA Ultra Low-Dropout CMOS Voltage Regulator With Power Good

Check for Samples: [LP3988](#)

## FEATURES

- 5 Bump Thin DSBGA Package
- SOT-23-5 Package
- Power-Good Flag Output
- Logic Controlled Enable
- Stable with Ceramic and High Quality Tantalum Capacitors
- Fast Turn-On
- Thermal Shutdown and Short-Circuit Current Limit

## KEY SPECIFICATIONS

- Input range: 2.5V to 6V
- Output current: 150mA
- PSRR at 10kHz: 40dB
- Quiescent current when shut down:  $\leq 1\mu\text{A}$
- (Typical) Fast Turn-On time: 100 $\mu\text{s}$
- Typical dropout with 150mA load: 80mV
- Junction temperature range for operation:  $-40^{\circ}\text{C}$  to  $+80^{\circ}\text{C}$
- Output voltages: 1.85V, 2.5V, 2.6V, 2.85V, 3V, and 3.3V

## APPLICATIONS

- CDMA Cellular Handsets
- Wideband CDMA Cellular Handsets
- GSM Cellular Handsets
- Portable Information Appliances
- Tiny 3.3V  $\pm 5\%$  to 2.85V, 150mA Converter

## DESCRIPTION

The LP3988 is a 150mA low dropout regulator designed specially to meet requirements of Portable battery-applications. The LP3988 is designed to work with a space saving, small 1 $\mu\text{F}$  ceramic capacitor. The LP3988 features an Error Flag output that indicates a faulty output condition.

The LP3988's performance is optimized for battery powered systems to deliver low noise, extremely low dropout voltage and low quiescent current. Regulator ground current increases only slightly in dropout, further prolonging the battery life.

Power supply rejection is better than 60 dB at low frequencies and starts to roll off at 10 kHz. High power supply rejection is maintained down to lower input voltage levels common to battery operated circuits.

The device is ideal for mobile phone and similar battery powered wireless applications. It provides up to 150 mA, from a 2.5V to 6V input, consuming less than 1  $\mu\text{A}$  in disable mode and has fast turn-on time less than 200 $\mu\text{s}$ .



Please be aware that an important notice concerning availability, standard warranty, and use in critical applications of Texas Instruments semiconductor products and disclaimers thereto appears at the end of this data sheet.

All trademarks are the property of their respective owners.

**Typical Application Circuit**

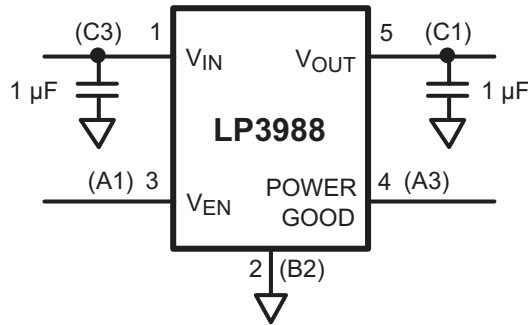

Note: Pin numbers in parentheses indicate DSBGA package pin out

**DESCRIPTION (CONTINUED)**

The LP3988 is available 5 pin SOT-23 package and 5 bump thin DSBGA package. Performance is specified for -40°C to +125°C temperature range and is available in 1.85, 2.5, 2.6, 2.85, 3.0 and 3.3V output voltages.

**Block Diagram**

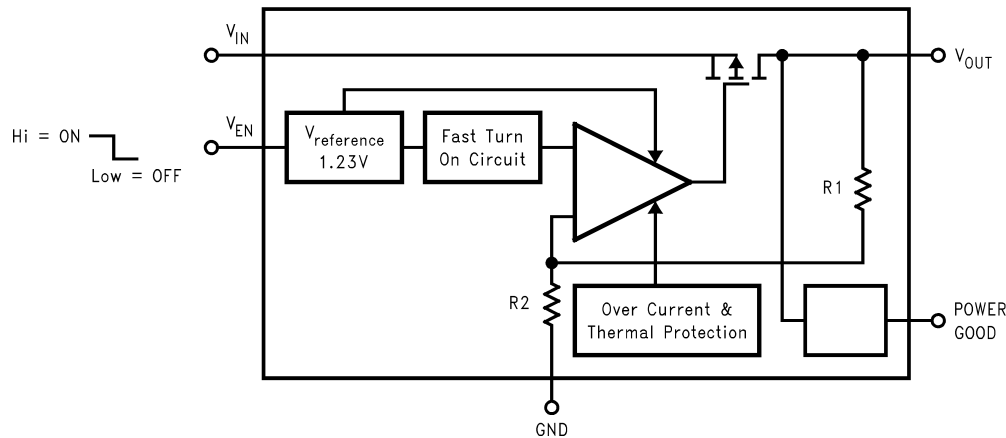

**PIN DESCRIPTIONS**

Name	DSBGA	SOT-23	Function
V <sub>EN</sub>	A1	3	Enable Input Logic, Enable High
GND	B2	2	Common Ground
V <sub>OUT</sub>	C1	5	Output Voltage of the LDO
V <sub>IN</sub>	C3	1	Input Voltage of the LDO
Power Good	A3	4	Power Good Flag (output): open-drain output, connected to an external pull-up resistor. Active low indicates an output voltage out of tolerance condition.

Connection Diagram

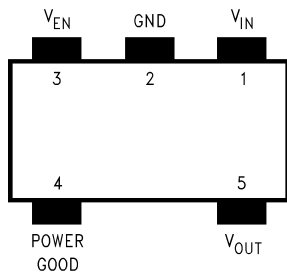

**Figure 1. Top View  
SOT-23-5 Package (DBV)  
See Package Number DBV (R-PDSO-G5)**

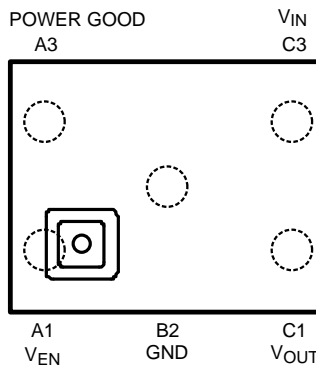

**Figure 2. Top View  
5 Bump DSBGA Package (YZR)  
See Package Number YZR0005**

**ORDERING INFORMATION (SOT-23-5 Package)<sup>(1)</sup>**

OUTPUT VOLTAGE (V)	GRADE	LP3988 SUPPLIED AS 1000 UNITS, TAPE AND REEL	LP3988 SUPPLIED AS 3000 UNITS, TAPE AND REEL	PACKAGE MARKING
2.5	STD	LP3988IMF-2.5	LP3988IMFX-2.5	LFSB
2.6	STD	LP3988IMF-2.6	LP3988IMFX-2.6	LDJB
2.85	STD	LP3988IMF-2.85	LP3988IMFX-2.85	LDLB
3.0	STD	LP3988IMF-3.0	LP3988IMFX-3.0	LFAB
3.3	STD	LP3988IMF-3.3	LP3988IMFX-3.3	LH5B

(1) For the most current package and ordering information, see the *Package Option Addendum* at the end of this document, or see the TI web site at [www.ti.com](http://www.ti.com).

**ORDERING INFORMATION (5 Bump DSBGA Package)<sup>(1)</sup>**

OUTPUT VOLTAGE (V)	GRADE	LP3988 SUPPLIED AS 250 UNITS, TAPE AND REEL	LP3988 SUPPLIED AS 3000 UNITS, TAPE AND REEL
1.85	STD	LP3988ITL-1.85	LP3988ITLX-1.85
2.6	STD	LP3988ITL-2.6	LP3988ITLX-2.6
2.85	STD	LP3988ITL-2.85	LP3988ITLX-2.85

(1) For the most current package and ordering information, see the *Package Option Addendum* at the end of this document, or see the TI web site at [www.ti.com](http://www.ti.com).



These devices have limited built-in ESD protection. The leads should be shorted together or the device placed in conductive foam during storage or handling to prevent electrostatic damage to the MOS gates.

**Absolute Maximum Ratings** (1)(2)(3)

$V_{IN}$	-0.3 to 6.5V
$V_{OUT}$ , $V_{EN}$ , PowerGood (applies only to DSBGA)	-0.3V to ( $V_{IN}+0.3V$ ), with 6V max
Junction Temperature	150°C
Storage Temperature	-65°C to +150°C
Lead Temp, Pad Temp.	235°C
Power Dissipation <sup>(4)</sup>	
SOT-23-5	364mW
DSBGA	314mW
ESD Rating <sup>(5)</sup>	
Human Body Model	2kV
Machine Model	
SOT-23-5 <sup>(6)</sup>	150V
DSBGA	200V

- (1) Absolute Maximum Ratings are limits beyond which damage to the device may occur. Operating Ratings are conditions under which operation of the device is specified. Operating Ratings do not imply performance limits. For performance limits and associated test conditions, see the Electrical Characteristics tables.
- (2) All voltages are with respect to the potential at the GND pin.
- (3) If Military/Aerospace specified devices are required, please contact the Texas Instruments Sales Office/ Distributors for availability and specifications.
- (4) The Absolute Maximum power dissipation depends on the ambient temperature and can be calculated using the formula:  $P_D = (T_J - T_A)/\theta_{JA}$  where  $T_J$  is the junction temperature,  $T_A$  is the ambient temperature, and  $\theta_{JA}$  is the junction-to-ambient thermal resistance. The 364mW rating appearing under Absolute Maximum Ratings for the SOT-23-5 package results from substituting the Absolute Maximum junction temperature, 150°C, for  $T_J$ , 70°C for  $T_A$ , and 220°C/W for  $\theta_{JA}$ . More power can be dissipated safely at ambient temperatures below 70°C. Less power can be dissipated safely at ambient temperatures above 70°C. The Absolute Maximum power dissipation can be increased by 4.5mW for each degree below 70°C, and it must be derated by 4.5mW for each degree above 70°C. Same principle applies to the DSBGA package.
- (5) The human body model is 100pF discharged through 1.5kΩ resistor into each pin. The machine model is a 200 pF capacitor discharged directly into each pin.
- (6) 100V machine model for Power-good flag, pin 4.

## Operating Ratings <sup>(1)</sup> <sup>(2)</sup>

$V_{IN}$ <sup>(3)</sup>	2.5V to 6V
$V_{OUT}$ , $V_{EN}$	0 to $V_{IN}$
Junction Temperature	-40°C to +125°C
Junction-to-Ambient Thermal Resistance ( $\theta_{JA}$ )	
SOT-23-5	220°C/W
DSBGA	255°C/W
Maximum Power Dissipation <sup>(4)</sup>	
SOT-23-5	250mW
DSBGA	216mW

- (1) Absolute Maximum Ratings are limits beyond which damage to the device may occur. Operating Ratings are conditions under which operation of the device is specified. Operating Ratings do not imply performance limits. For performance limits and associated test conditions, see the Electrical Characteristics tables.
- (2) All voltages are with respect to the potential at the GND pin.
- (3) The minimum  $V_{IN}$  is dependant on the device output option. For  $V_{out(NOM)} < 2.5V$ ,  $V_{IN(MIN)}$  will equal 2.5V. For  $V_{out(NOM)} \geq 2.5V$ ,  $V_{IN(MIN)}$  will equal  $V_{out(NOM)} + 200mV$ .
- (4) Like the Absolute Maximum power dissipation, the maximum power dissipation for operation depends on the ambient temperature. The 250mW rating appearing under Operating Ratings for the SOT-23-5 package results from substituting the maximum junction temperature for operation, 125°C, for  $T_J$ , 70°C for  $T_A$ , and 220°C/W for  $\theta_{JA}$  into <sup>(1)</sup> above. More power can be dissipated at ambient temperatures below 70°C. Less power can be dissipated at ambient temperatures above 70°C. The maximum power dissipation for operation can be increased by 4.5mW for each degree below 70°C, and it must be derated by 4.5mW for each degree above 70°C. Same principle applies to the DSBGA package.

## Electrical Characteristics

Unless otherwise specified:  $V_{EN} = 1.8V$ ,  $V_{IN} = V_{OUT} + 0.5V$ ,  $C_{IN} = 1 \mu F$ ,  $I_{OUT} = 1mA$ ,  $C_{OUT} = 1 \mu F$ . Typical values and limits appearing in standard typeface are for  $T_J = 25^\circ C$ . Limits appearing in **boldface type** apply over the entire junction temperature range for operation, -40°C to +125°C. <sup>(1)</sup> <sup>(2)</sup>

Symbol	Parameter	Conditions	Typ	Limit		Units
				Min	Max	
$\Delta V_{OUT}$	Output Voltage Tolerance	-20°C $\leq T_J \leq$ 125°C, SOT-23-5		-2	2	% of $V_{OUT(nom)}$
		-40°C $\leq T_J \leq$ 125°C, SOT-23-5		<b>-3</b>	<b>3</b>	
		-40°C $\leq T_J \leq$ 125°C, DSBGA		<b>-3</b>	<b>3</b>	
	Line Regulation Error	$V_{IN} = V_{OUT(NOM)} + 0.5V$ to 6.0V		-0.15	0.15	%/V
	Load Regulation Error <sup>(3)</sup>	$I_{OUT} = 1 mA$ to 150 mA			0.005	%/mA
				<b>0.007</b>		
PSRR	Power Supply Rejection Ratio	$V_{IN} = V_{OUT(nom)} + 1V$ , $f = 1 kHz$ , $I_{OUT} = 50 mA$ (Figure 5)	65			dB
		$V_{IN} = V_{OUT(nom)} + 1V$ , $f = 10 kHz$ , $I_{OUT} = 50 mA$ (Figure 5)	45			
$I_Q$	Quiescent Current	$V_{EN} = 1.4V$ , $I_{OUT} = 0 mA$	85		120	$\mu A$
		$V_{EN} = 1.4V$ , $I_{OUT} = 0$ to 150 mA			<b>200</b>	
		$V_{EN} = 0.4V$	0.003		<b>1.0</b>	
	Dropout Voltage <sup>(4)</sup>	$I_{OUT} = 1 mA$	1		<b>5</b>	mV
		$I_{OUT} = 150 mA$	80		<b>115</b> <b>150</b>	
$I_{SC}$	Short Circuit Current Limit	<sup>(5)</sup>	600			mA
$e_n$	Output Noise Voltage	BW = 10 Hz to 100 kHz, $C_{OUT} = 1 \mu F$	220			$\mu V_{rms}$

- (1) All electrical characteristics having room-temperature limits are tested during production with  $T_J = 25^\circ C$  or correlated using Statistical Quality Control (SQC) methods. All hot and cold limits are specified by correlating the electrical characteristics to process and temperature variations and applying statistical process control.
- (2) The target output voltage, which is labeled  $V_{OUT(nom)}$ , is the desired voltage option.
- (3) An increase in the load current results in a slight decrease in the output voltage and vice versa.
- (4) Dropout voltage is the input-to-output voltage difference at which the output voltage is 100mV below its nominal value.
- (5) Short circuit current is measured on input supply line after pulling down  $V_{OUT}$  to 95%  $V_{OUT(nom)}$ .

## Electrical Characteristics (continued)

Unless otherwise specified:  $V_{EN} = 1.8V$ ,  $V_{IN} = V_{OUT} + 0.5V$ ,  $C_{IN} = 1 \mu F$ ,  $I_{OUT} = 1mA$ ,  $C_{OUT} = 1 \mu F$ . Typical values and limits appearing in standard typeface are for  $T_J = 25^\circ C$ . Limits appearing in **boldface type** apply over the entire junction temperature range for operation,  $-40^\circ C$  to  $+125^\circ C$ . <sup>(1)</sup> <sup>(2)</sup>

Symbol	Parameter	Conditions	Typ	Limit		Units
				Min	Max	
C <sub>OUT</sub>	Output Capacitor	Capacitance <sup>(6)</sup>		<b>1</b>	<b>20</b>	$\mu F$
		ESR <sup>(6)</sup>		<b>5</b>	<b>500</b>	m $\Omega$
TSD	Thermal Shutdown Temperature		160			$^\circ C$
	Thermal Shutdown Hysteresis		20			$^\circ C$
<b>Enable Control Characteristics</b>						
I <sub>EN</sub>	Maximum Input Current at EN	$V_{EN} = 0$ and $V_{IN} = 6.0V$			<b>0.1</b>	$\mu A$
V <sub>IL</sub>	Logic Low Input threshold	$V_{IN} = 2.5V$ to $6.0V$			<b>0.5</b>	V
V <sub>IH</sub>	Logic High Input threshold	$V_{IN} = 2.5V$ to $6.0V$		<b>1.2</b>		V
<b>Power Good</b>						
V <sub>THL</sub> V <sub>THH</sub>	Power Good Low threshold	% of $V_{OUT}$ (PG ON) <a href="#">Figure 4</a>	93	90	95	%
	High Threshold	% of $V_{OUT}$ (PG OFF) <a href="#">Figure 4</a> <sup>(7)</sup>	95	92	98	
V <sub>OL</sub>	PG Output Logic Low Voltage	$I_{PULL-UP} = 100\mu A$ , fault condition	0.02		<b>0.1</b>	V
I <sub>PGL</sub>	PG Output Leakage Current	PG Off, $V_{PG} = 6V$	0.02			$\mu A$
T <sub>ON</sub>	Power Good Turn On time, <sup>(8)</sup>	$V_{IN} = 4.2V$	10			$\mu s$
T <sub>OFF</sub>	Power Good Turn Off time, <sup>(8)</sup>	$V_{IN} = 4.2V$	10			$\mu s$

(6) Specified by design. Not production tested. The capacitor tolerance should be  $\pm 30\%$  or better over the full temperature range. The full range of operating conditions such as temperature, DC bias and even capacitor case size for the capacitor in the application should be considered during device selection to ensure this minimum capacitance specification is met. X7R capacitor types are recommended to meet the full device temperature range.

(7) The low and high thresholds are generated together. Typically a 2.6% difference is seen between these thresholds.

(8) Turn-on time is measured between the enable input just exceeding  $V_{IH}$  and the output voltage just reaching 95% of its nominal value.

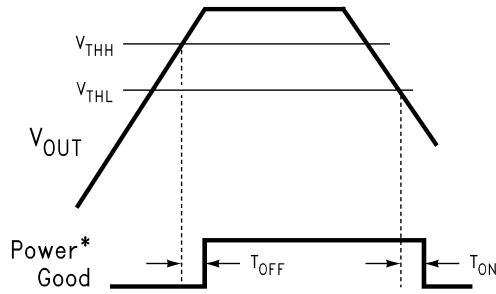

\*Power good pin pulled up to  $V_{OUT}$  through an external pull-up resistor.

**Figure 3. Power Good Flag Timing**

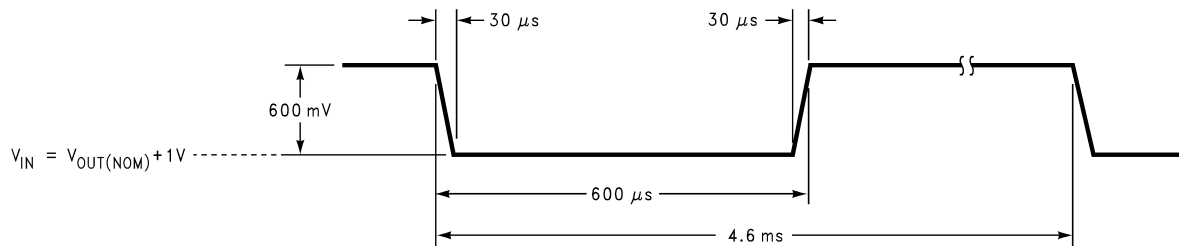

**Figure 4. Line Transient response Input Perturbation**

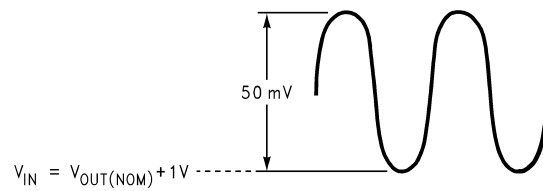

**Figure 5. PSRR Input Perturbation**

### Typical Performance Characteristics

Unless otherwise specified,  $C_{IN} = C_{OUT} = 1 \mu F$  Ceramic,  $V_{IN} = V_{OUT} + 0.2V$ ,  $T_A = 25^\circ C$ , Enable pin is tied to  $V_{IN}$ .

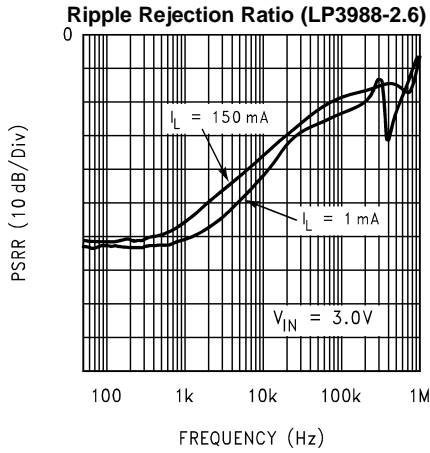

Figure 6.

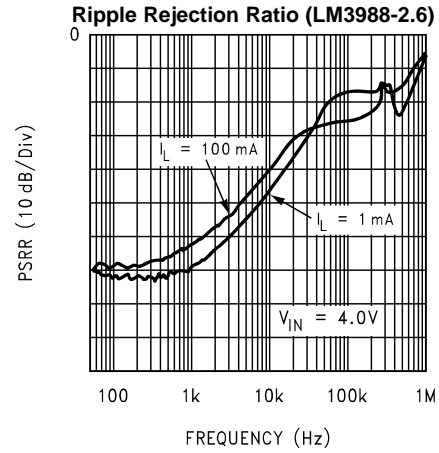

Figure 7.

**Power-Good Response Time (LP3988-2.85)**  
 (flag pin pulled to  $V_{OUT}$  through a  $100K\Omega$  resistor)

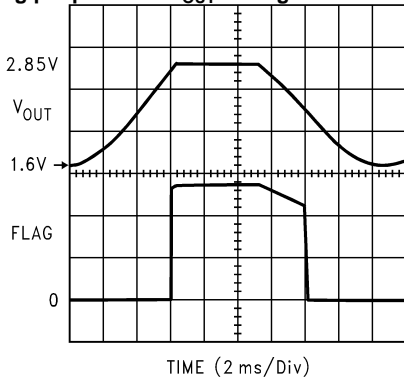

Figure 8.

**Power-Good Response Time (LP3988-2.85)**  
 (flag pin pulled to  $V_{IN}$  through a  $100K\Omega$  resistor)

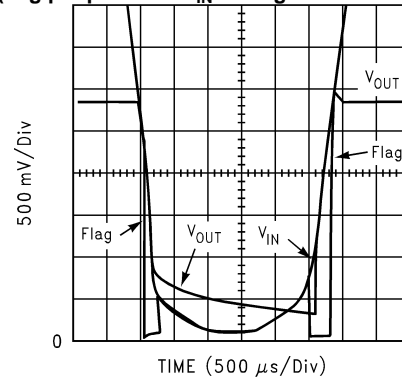

Figure 9.

**Power-Good Response Time (LP3988-2.85)**  
 (flag pin pulled to  $V_{OUT}$  through a  $100K\Omega$  resistor)

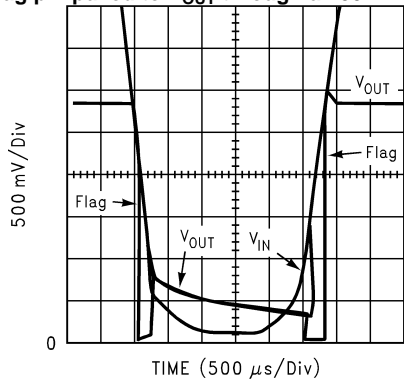

Figure 10.

**Line Transient Response (LP3988-2.85)**

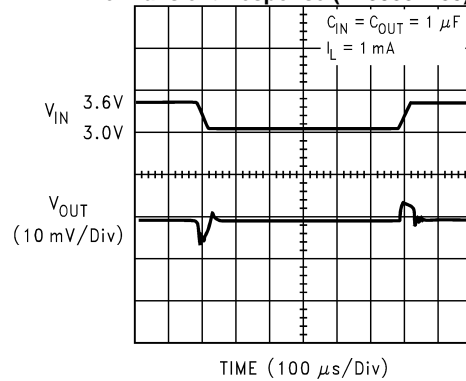
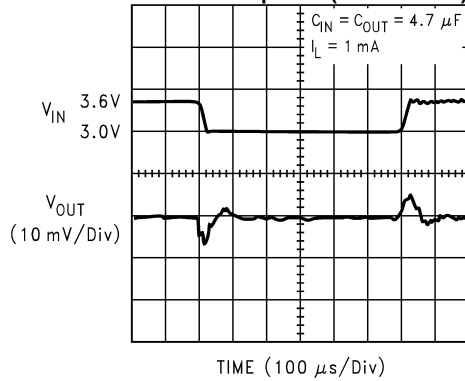

Figure 11.

**Typical Performance Characteristics (continued)**

Unless otherwise specified,  $C_{IN} = C_{OUT} = 1 \mu\text{F}$  Ceramic,  $V_{IN} = V_{OUT} + 0.2\text{V}$ ,  $T_A = 25^\circ\text{C}$ , Enable pin is tied to  $V_{IN}$ .

**Line Transient Response (LP3988-2.85)**



**Figure 12.**

**Power-Up Response**

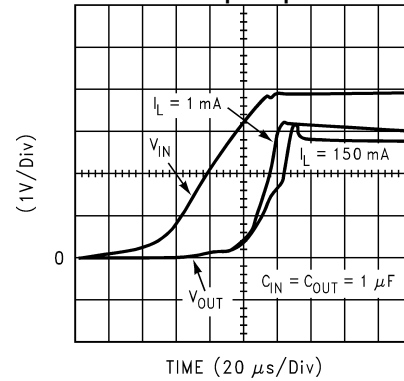

**Figure 13.**

**Enable Response**

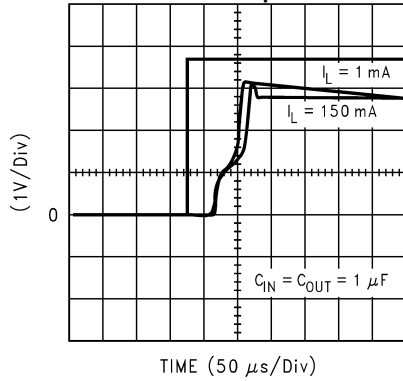

**Figure 14.**

**Enable Response**

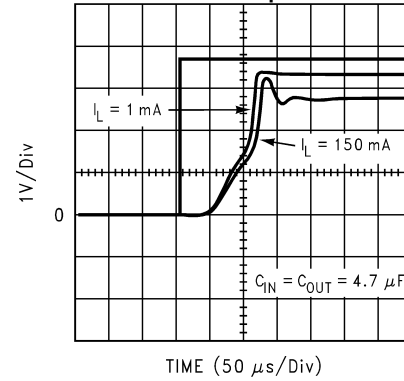

**Figure 15.**

**Load Transient Response**

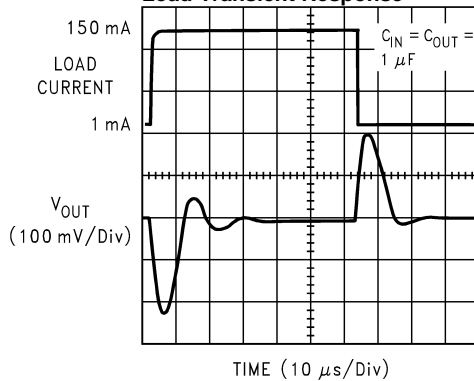

**Figure 16.**

**Load Transient Response**

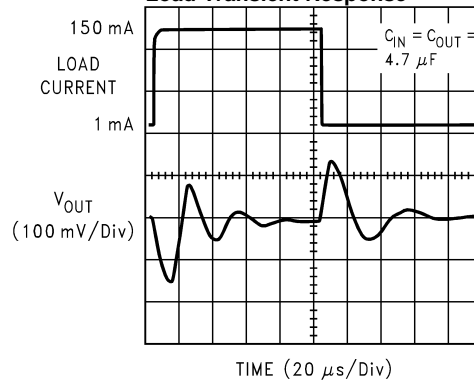

**Figure 17.**

## APPLICATION HINTS

### EXTERNAL CAPACITORS

Like any low-dropout regulator, the LP3988 requires external capacitors for regulator stability. The LP3988 is specifically designed for portable applications requiring minimum board space and smallest components. These capacitors must be correctly selected for good performance.

### INPUT CAPACITOR

An input capacitance of  $\approx 1\mu\text{F}$  is required between the LP3988 input pin and ground (the amount of the capacitance may be increased without limit).

This capacitor must be located a distance of not more than 1cm from the input pin and returned to a clean analog ground. Any good quality ceramic, tantalum, or film capacitor may be used at the input.

**Important:** Tantalum capacitors can suffer catastrophic failures due to surge current when connected to a low-impedance source of power (like a battery or a very large capacitor). If a tantalum capacitor is used at the input, it must be ensured by the manufacturer to have a surge current rating sufficient for the application.

There are no requirements for the ESR on the input capacitor, but tolerance and temperature coefficient must be considered when selecting the capacitor to ensure the capacitance will be  $\approx 1\mu\text{F}$  over the entire operating temperature range.

### OUTPUT CAPACITOR

The LP3988 is designed specifically to work with very small ceramic output capacitors. A ceramic capacitor (dielectric types Z5U, Y5V or X7R) in 1 to 22  $\mu\text{F}$  range with 5m $\Omega$  to 500m $\Omega$  ESR range is suitable in the LP3988 application circuit.

It may also be possible to use tantalum or film capacitors at the output, but these are not as attractive for reasons of size and cost (see [CAPACITOR CHARACTERISTICS](#)).

The output capacitor must meet the requirement for minimum amount of capacitance and also have an ESR (Equivalent Series Resistance) value which is within a stable range (5 m $\Omega$  to 500 m $\Omega$ ).

### NO-LOAD STABILITY

The LP3988 will remain stable and in regulation with no external load. This is specially important in CMOS RAM keep-alive applications.

### CAPACITOR CHARACTERISTICS

The LP3988 is designed to work with ceramic capacitors on the output to take advantage of the benefits they offer: for capacitance values in the range of 1 $\mu\text{F}$  to 4.7 $\mu\text{F}$  range, ceramic capacitors are the smallest, least expensive and have the lowest ESR values (which makes them best for eliminating high frequency noise). The ESR of a typical 1 $\mu\text{F}$  ceramic capacitor is in the range of 20 m $\Omega$  to 40 m $\Omega$ , which easily meets the ESR requirement for stability by the LP3988.

The ceramic capacitor's capacitance can vary with temperature. Most large value ceramic capacitors ( $\approx 2.2\mu\text{F}$ ) are manufactured with Z5U or Y5V temperature characteristics, which results in the capacitance dropping by more than 50% as the temperature goes from 25°C to 85°C.

A better choice for temperature coefficient in a ceramic capacitor is X7R, which holds the capacitance within  $\pm 15\%$ .

Tantalum capacitors are less desirable than ceramic for use as output capacitors because they are more expensive when comparing equivalent capacitance and voltage ratings in the 1 $\mu\text{F}$  to 4.7 $\mu\text{F}$  range.

Another important consideration is that tantalum capacitors have higher ESR values than equivalent size ceramics. This means that while it may be possible to find a tantalum capacitor with an ESR value within the stable range, it would have to be larger in capacitance (which means bigger and more costly ) than a ceramic capacitor with the same ESR value. It should also be noted that the ESR of a typical tantalum will increase about 2:1 as the temperature goes from 25°C down to -40°C, so some guard band must be allowed.

## ON/OFF INPUT OPERATION

The LP3988 is turned off by pulling the  $V_{EN}$  pin low, and turned on by pulling it high. If this feature is not used, the  $V_{EN}$  pin should be tied to  $V_{IN}$  to keep the regulator output on at all time. To assure proper operation, the signal source used to drive the  $V_{EN}$  input must be able to swing above and below the specified turn-on/off voltage thresholds listed in the Electrical Characteristics section under  $V_{IL}$  and  $V_{IH}$ .

## FAST ON-TIME

The LP3988 utilizes a speed up circuitry to ramp up the internal  $V_{REF}$  voltage to its final value to achieve a fast output turn on time.

## REVISION HISTORY

Changes from Revision C (May 2013) to Revision D	Page
• Changed layout of National Data Sheet to TI format .....	11

**PACKAGING INFORMATION**

Orderable Device	Status (1)	Package Type	Package Drawing	Pins	Package Qty	Eco Plan (2)	Lead/Ball Finish	MSL Peak Temp (3)	Op Temp (°C)	Top-Side Markings (4)	Samples
LP3988IMF-2.5	ACTIVE	SOT-23	DBV	5	1000	TBD	Call TI	Call TI	-40 to 125	LFSB	<a href="#">Samples</a>
LP3988IMF-2.5/NOPB	ACTIVE	SOT-23	DBV	5	1000	Green (RoHS & no Sb/Br)	CU SN	Level-1-260C-UNLIM	-40 to 125	LFSB	<a href="#">Samples</a>
LP3988IMF-3.0	ACTIVE	SOT-23	DBV	5	1000	TBD	Call TI	Call TI	-40 to 125	LFAB	<a href="#">Samples</a>
LP3988IMF-3.0/NOPB	ACTIVE	SOT-23	DBV	5	1000	Green (RoHS & no Sb/Br)	CU SN	Level-1-260C-UNLIM	-40 to 125	LFAB	<a href="#">Samples</a>
LP3988IMF-3.3	ACTIVE	SOT-23	DBV	5	1000	TBD	Call TI	Call TI		LH5B	<a href="#">Samples</a>
LP3988IMF-3.3/NOPB	ACTIVE	SOT-23	DBV	5	1000	Green (RoHS & no Sb/Br)	CU SN	Level-1-260C-UNLIM		LH5B	<a href="#">Samples</a>
LP3988IMFX-2.5	ACTIVE	SOT-23	DBV	5	3000	TBD	Call TI	Call TI	-40 to 125	LFSB	<a href="#">Samples</a>
LP3988IMFX-2.5/NOPB	ACTIVE	SOT-23	DBV	5	3000	Green (RoHS & no Sb/Br)	CU SN	Level-1-260C-UNLIM	-40 to 125	LFSB	<a href="#">Samples</a>
LP3988IMFX-2.85/NOPB	ACTIVE	SOT-23	DBV	5	3000	Green (RoHS & no Sb/Br)	CU SN	Level-1-260C-UNLIM	-40 to 125	LDLB	<a href="#">Samples</a>
LP3988IMFX-3.0/NOPB	ACTIVE	SOT-23	DBV	5	3000	Green (RoHS & no Sb/Br)	CU SN	Level-1-260C-UNLIM	-40 to 125	LFAB	<a href="#">Samples</a>
LP3988IMFX-3.3/NOPB	ACTIVE	SOT-23	DBV	5	3000	Green (RoHS & no Sb/Br)	CU SN	Level-1-260C-UNLIM		LH5B	<a href="#">Samples</a>
LP3988ITL-1.85/NOPB	ACTIVE	DSBGA	YZR	5	250	Green (RoHS & no Sb/Br)	SNAGCU	Level-1-260C-UNLIM		8	<a href="#">Samples</a>
LP3988ITL-2.6/NOPB	ACTIVE	DSBGA	YZR	5	250	Green (RoHS & no Sb/Br)	SNAGCU	Level-1-260C-UNLIM	-40 to 125	8	<a href="#">Samples</a>
LP3988ITL-2.85/NOPB	ACTIVE	DSBGA	YZR	5	250	Green (RoHS & no Sb/Br)	SNAGCU	Level-1-260C-UNLIM	-40 to 125	8	<a href="#">Samples</a>
LP3988ITLX-1.85/NOPB	ACTIVE	DSBGA	YZR	5	3000	Green (RoHS & no Sb/Br)	SNAGCU	Level-1-260C-UNLIM		8	<a href="#">Samples</a>
LP3988ITLX-2.6/NOPB	ACTIVE	DSBGA	YZR	5	3000	Green (RoHS & no Sb/Br)	SNAGCU	Level-1-260C-UNLIM	-40 to 125	8	<a href="#">Samples</a>
LP3988ITLX-2.85/NOPB	ACTIVE	DSBGA	YZR	5	3000	Green (RoHS & no Sb/Br)	SNAGCU	Level-1-260C-UNLIM	-40 to 125	8	<a href="#">Samples</a>

(1) The marketing status values are defined as follows:

---

**ACTIVE:** Product device recommended for new designs.

**LIFEBUY:** TI has announced that the device will be discontinued, and a lifetime-buy period is in effect.

**NRND:** Not recommended for new designs. Device is in production to support existing customers, but TI does not recommend using this part in a new design.

**PREVIEW:** Device has been announced but is not in production. Samples may or may not be available.

**OBSOLETE:** TI has discontinued the production of the device.

<sup>(2)</sup> Eco Plan - The planned eco-friendly classification: Pb-Free (RoHS), Pb-Free (RoHS Exempt), or Green (RoHS & no Sb/Br) - please check <http://www.ti.com/productcontent> for the latest availability information and additional product content details.

**TBD:** The Pb-Free/Green conversion plan has not been defined.

**Pb-Free (RoHS):** TI's terms "Lead-Free" or "Pb-Free" mean semiconductor products that are compatible with the current RoHS requirements for all 6 substances, including the requirement that lead not exceed 0.1% by weight in homogeneous materials. Where designed to be soldered at high temperatures, TI Pb-Free products are suitable for use in specified lead-free processes.

**Pb-Free (RoHS Exempt):** This component has a RoHS exemption for either 1) lead-based flip-chip solder bumps used between the die and package, or 2) lead-based die adhesive used between the die and leadframe. The component is otherwise considered Pb-Free (RoHS compatible) as defined above.

**Green (RoHS & no Sb/Br):** TI defines "Green" to mean Pb-Free (RoHS compatible), and free of Bromine (Br) and Antimony (Sb) based flame retardants (Br or Sb do not exceed 0.1% by weight in homogeneous material)

<sup>(3)</sup> MSL, Peak Temp. -- The Moisture Sensitivity Level rating according to the JEDEC industry standard classifications, and peak solder temperature.

<sup>(4)</sup> Multiple Top-Side Markings will be inside parentheses. Only one Top-Side Marking contained in parentheses and separated by a "~" will appear on a device. If a line is indented then it is a continuation of the previous line and the two combined represent the entire Top-Side Marking for that device.

**Important Information and Disclaimer:** The information provided on this page represents TI's knowledge and belief as of the date that it is provided. TI bases its knowledge and belief on information provided by third parties, and makes no representation or warranty as to the accuracy of such information. Efforts are underway to better integrate information from third parties. TI has taken and continues to take reasonable steps to provide representative and accurate information but may not have conducted destructive testing or chemical analysis on incoming materials and chemicals. TI and TI suppliers consider certain information to be proprietary, and thus CAS numbers and other limited information may not be available for release.

In no event shall TI's liability arising out of such information exceed the total purchase price of the TI part(s) at issue in this document sold by TI to Customer on an annual basis.

**TAPE AND REEL INFORMATION**

**QUADRANT ASSIGNMENTS FOR PIN 1 ORIENTATION IN TAPE**

\*All dimensions are nominal

Device	Package Type	Package Drawing	Pins	SPQ	Reel Diameter (mm)	Reel Width W1 (mm)	A0 (mm)	B0 (mm)	K0 (mm)	P1 (mm)	W (mm)	Pin1 Quadrant
LP3988IMF-2.5	SOT-23	DBV	5	1000	178.0	8.4	3.2	3.2	1.4	4.0	8.0	Q3
LP3988IMF-2.5/NOPB	SOT-23	DBV	5	1000	178.0	8.4	3.2	3.2	1.4	4.0	8.0	Q3
LP3988IMF-3.0	SOT-23	DBV	5	1000	178.0	8.4	3.2	3.2	1.4	4.0	8.0	Q3
LP3988IMF-3.0/NOPB	SOT-23	DBV	5	1000	178.0	8.4	3.2	3.2	1.4	4.0	8.0	Q3
LP3988IMF-3.3	SOT-23	DBV	5	1000	178.0	8.4	3.2	3.2	1.4	4.0	8.0	Q3
LP3988IMF-3.3/NOPB	SOT-23	DBV	5	1000	178.0	8.4	3.2	3.2	1.4	4.0	8.0	Q3
LP3988IMFX-2.5	SOT-23	DBV	5	3000	178.0	8.4	3.2	3.2	1.4	4.0	8.0	Q3
LP3988IMFX-2.5/NOPB	SOT-23	DBV	5	3000	178.0	8.4	3.2	3.2	1.4	4.0	8.0	Q3
LP3988IMFX-2.85/NOPB	SOT-23	DBV	5	3000	178.0	8.4	3.2	3.2	1.4	4.0	8.0	Q3
LP3988IMFX-3.0/NOPB	SOT-23	DBV	5	3000	178.0	8.4	3.2	3.2	1.4	4.0	8.0	Q3
LP3988IMFX-3.3/NOPB	SOT-23	DBV	5	3000	178.0	8.4	3.2	3.2	1.4	4.0	8.0	Q3
LP3988ITL-1.85/NOPB	DSBGA	YZR	5	250	178.0	8.4	1.09	1.55	0.76	4.0	8.0	Q1
LP3988ITL-2.6/NOPB	DSBGA	YZR	5	250	178.0	8.4	1.09	1.55	0.76	4.0	8.0	Q1
LP3988ITL-2.85/NOPB	DSBGA	YZR	5	250	178.0	8.4	1.09	1.55	0.76	4.0	8.0	Q1
LP3988ITLX-1.85/NOPB	DSBGA	YZR	5	3000	178.0	8.4	1.09	1.55	0.76	4.0	8.0	Q1
LP3988ITLX-2.6/NOPB	DSBGA	YZR	5	3000	178.0	8.4	1.09	1.55	0.76	4.0	8.0	Q1
LP3988ITLX-2.85/NOPB	DSBGA	YZR	5	3000	178.0	8.4	1.09	1.55	0.76	4.0	8.0	Q1

**TAPE AND REEL BOX DIMENSIONS**

\*All dimensions are nominal

Device	Package Type	Package Drawing	Pins	SPQ	Length (mm)	Width (mm)	Height (mm)
LP3988IMF-2.5	SOT-23	DBV	5	1000	210.0	185.0	35.0
LP3988IMF-2.5/NOPB	SOT-23	DBV	5	1000	210.0	185.0	35.0
LP3988IMF-3.0	SOT-23	DBV	5	1000	210.0	185.0	35.0
LP3988IMF-3.0/NOPB	SOT-23	DBV	5	1000	210.0	185.0	35.0
LP3988IMF-3.3	SOT-23	DBV	5	1000	210.0	185.0	35.0
LP3988IMF-3.3/NOPB	SOT-23	DBV	5	1000	210.0	185.0	35.0
LP3988IMFX-2.5	SOT-23	DBV	5	3000	210.0	185.0	35.0
LP3988IMFX-2.5/NOPB	SOT-23	DBV	5	3000	210.0	185.0	35.0
LP3988IMFX-2.85/NOPB	SOT-23	DBV	5	3000	210.0	185.0	35.0
LP3988IMFX-3.0/NOPB	SOT-23	DBV	5	3000	210.0	185.0	35.0
LP3988IMFX-3.3/NOPB	SOT-23	DBV	5	3000	210.0	185.0	35.0
LP3988ITL-1.85/NOPB	DSBGA	YZR	5	250	210.0	185.0	35.0
LP3988ITL-2.6/NOPB	DSBGA	YZR	5	250	210.0	185.0	35.0
LP3988ITL-2.85/NOPB	DSBGA	YZR	5	250	210.0	185.0	35.0
LP3988ITLX-1.85/NOPB	DSBGA	YZR	5	3000	210.0	185.0	35.0
LP3988ITLX-2.6/NOPB	DSBGA	YZR	5	3000	210.0	185.0	35.0
LP3988ITLX-2.85/NOPB	DSBGA	YZR	5	3000	210.0	185.0	35.0

DBV (R-PDSO-G5)

PLASTIC SMALL-OUTLINE PACKAGE

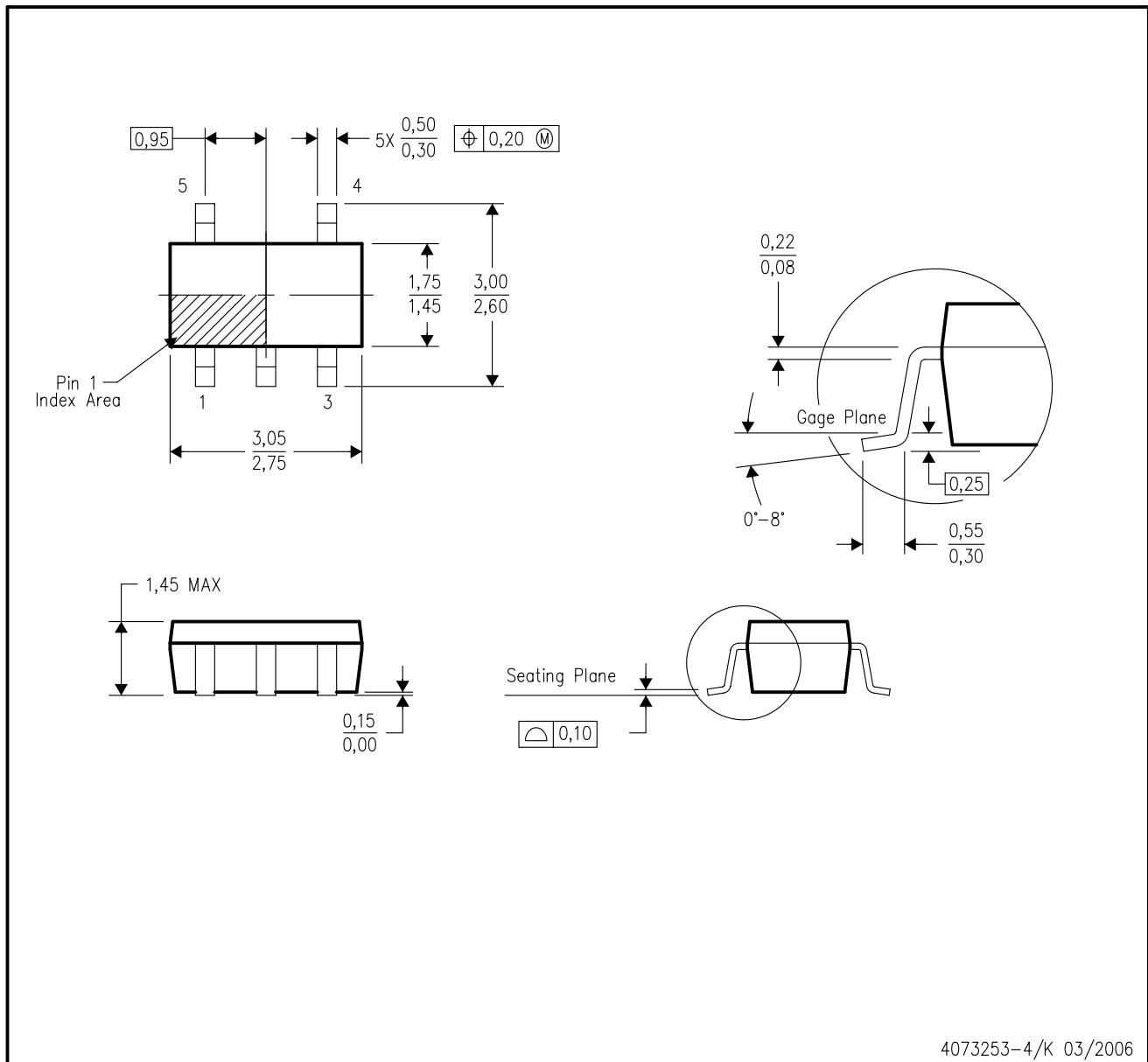

- NOTES:
- A. All linear dimensions are in millimeters.
  - B. This drawing is subject to change without notice.
  - C. Body dimensions do not include mold flash or protrusion. Mold flash and protrusion shall not exceed 0.15 per side.
  - D. Falls within JEDEC MO-178 Variation AA.

DBV (R-PDSO-G5)

PLASTIC SMALL OUTLINE



- NOTES:
- A. All linear dimensions are in millimeters.
  - B. This drawing is subject to change without notice.
  - C. Customers should place a note on the circuit board fabrication drawing not to alter the center solder mask defined pad.
  - D. Publication IPC-7351 is recommended for alternate designs.
  - E. Laser cutting apertures with trapezoidal walls and also rounding corners will offer better paste release. Customers should contact their board assembly site for stencil design recommendations. Example stencil design based on a 50% volumetric metal load solder paste. Refer to IPC-7525 for other stencil recommendations.

YZR0005

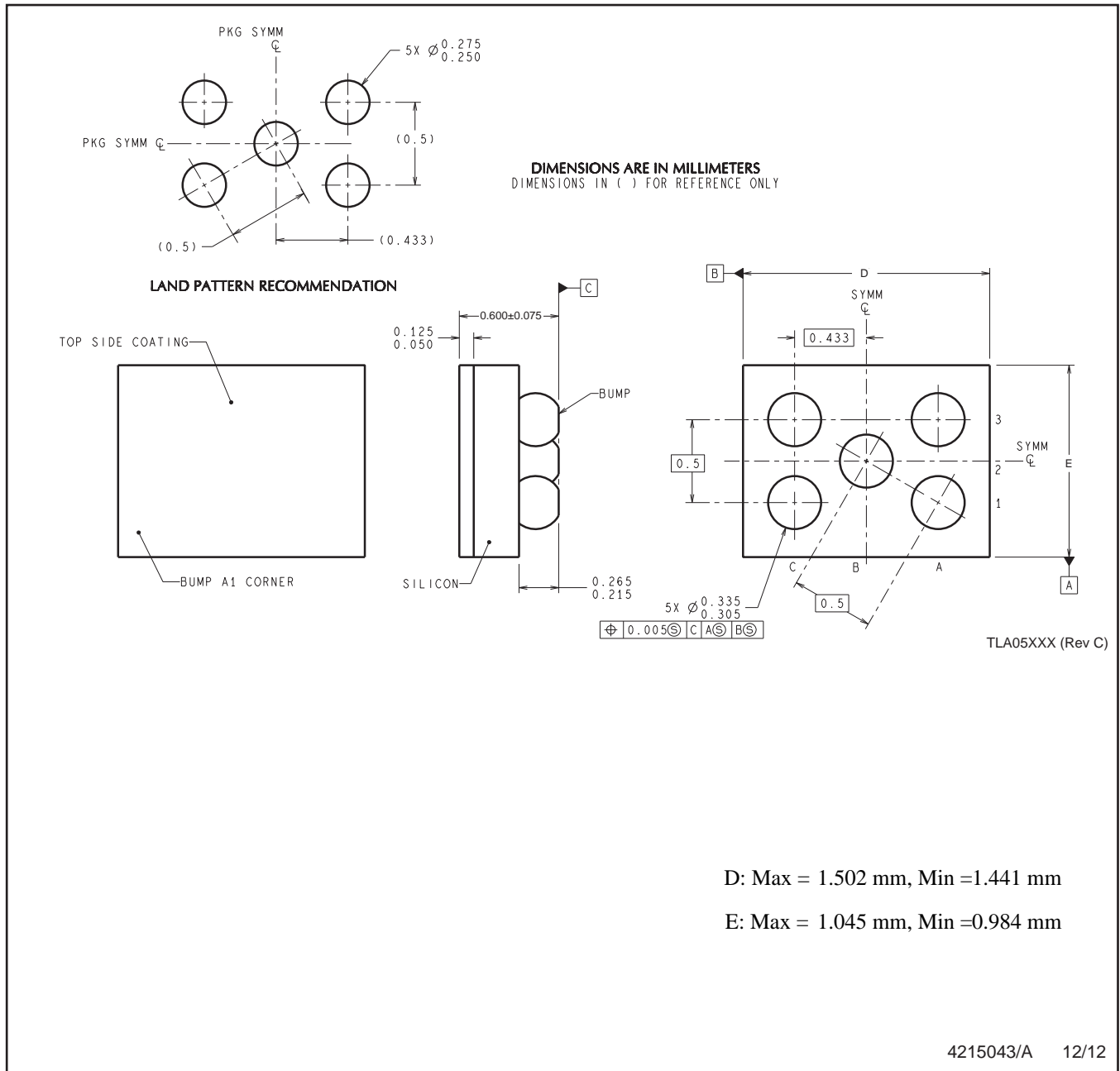

NOTES: A. All linear dimensions are in millimeters. Dimensioning and tolerancing per ASME Y14.5M-1994.  
 B. This drawing is subject to change without notice.

## IMPORTANT NOTICE

Texas Instruments Incorporated and its subsidiaries (TI) reserve the right to make corrections, enhancements, improvements and other changes to its semiconductor products and services per JESD46, latest issue, and to discontinue any product or service per JESD48, latest issue. Buyers should obtain the latest relevant information before placing orders and should verify that such information is current and complete. All semiconductor products (also referred to herein as "components") are sold subject to TI's terms and conditions of sale supplied at the time of order acknowledgment.

TI warrants performance of its components to the specifications applicable at the time of sale, in accordance with the warranty in TI's terms and conditions of sale of semiconductor products. Testing and other quality control techniques are used to the extent TI deems necessary to support this warranty. Except where mandated by applicable law, testing of all parameters of each component is not necessarily performed.

TI assumes no liability for applications assistance or the design of Buyers' products. Buyers are responsible for their products and applications using TI components. To minimize the risks associated with Buyers' products and applications, Buyers should provide adequate design and operating safeguards.

TI does not warrant or represent that any license, either express or implied, is granted under any patent right, copyright, mask work right, or other intellectual property right relating to any combination, machine, or process in which TI components or services are used. Information published by TI regarding third-party products or services does not constitute a license to use such products or services or a warranty or endorsement thereof. Use of such information may require a license from a third party under the patents or other intellectual property of the third party, or a license from TI under the patents or other intellectual property of TI.

Reproduction of significant portions of TI information in TI data books or data sheets is permissible only if reproduction is without alteration and is accompanied by all associated warranties, conditions, limitations, and notices. TI is not responsible or liable for such altered documentation. Information of third parties may be subject to additional restrictions.

Resale of TI components or services with statements different from or beyond the parameters stated by TI for that component or service voids all express and any implied warranties for the associated TI component or service and is an unfair and deceptive business practice. TI is not responsible or liable for any such statements.

Buyer acknowledges and agrees that it is solely responsible for compliance with all legal, regulatory and safety-related requirements concerning its products, and any use of TI components in its applications, notwithstanding any applications-related information or support that may be provided by TI. Buyer represents and agrees that it has all the necessary expertise to create and implement safeguards which anticipate dangerous consequences of failures, monitor failures and their consequences, lessen the likelihood of failures that might cause harm and take appropriate remedial actions. Buyer will fully indemnify TI and its representatives against any damages arising out of the use of any TI components in safety-critical applications.

In some cases, TI components may be promoted specifically to facilitate safety-related applications. With such components, TI's goal is to help enable customers to design and create their own end-product solutions that meet applicable functional safety standards and requirements. Nonetheless, such components are subject to these terms.

No TI components are authorized for use in FDA Class III (or similar life-critical medical equipment) unless authorized officers of the parties have executed a special agreement specifically governing such use.

Only those TI components which TI has specifically designated as military grade or "enhanced plastic" are designed and intended for use in military/aerospace applications or environments. Buyer acknowledges and agrees that any military or aerospace use of TI components which have **not** been so designated is solely at the Buyer's risk, and that Buyer is solely responsible for compliance with all legal and regulatory requirements in connection with such use.

TI has specifically designated certain components as meeting ISO/TS16949 requirements, mainly for automotive use. In any case of use of non-designated products, TI will not be responsible for any failure to meet ISO/TS16949.

### Products

Audio	<a href="http://www.ti.com/audio">www.ti.com/audio</a>
Amplifiers	<a href="http://amplifier.ti.com">amplifier.ti.com</a>
Data Converters	<a href="http://dataconverter.ti.com">dataconverter.ti.com</a>
DLP® Products	<a href="http://www.dlp.com">www.dlp.com</a>
DSP	<a href="http://dsp.ti.com">dsp.ti.com</a>
Clocks and Timers	<a href="http://www.ti.com/clocks">www.ti.com/clocks</a>
Interface	<a href="http://interface.ti.com">interface.ti.com</a>
Logic	<a href="http://logic.ti.com">logic.ti.com</a>
Power Mgmt	<a href="http://power.ti.com">power.ti.com</a>
Microcontrollers	<a href="http://microcontroller.ti.com">microcontroller.ti.com</a>
RFID	<a href="http://www.ti-rfid.com">www.ti-rfid.com</a>
OMAP Applications Processors	<a href="http://www.ti.com/omap">www.ti.com/omap</a>
Wireless Connectivity	<a href="http://www.ti.com/wirelessconnectivity">www.ti.com/wirelessconnectivity</a>

### Applications

Automotive and Transportation	<a href="http://www.ti.com/automotive">www.ti.com/automotive</a>
Communications and Telecom	<a href="http://www.ti.com/communications">www.ti.com/communications</a>
Computers and Peripherals	<a href="http://www.ti.com/computers">www.ti.com/computers</a>
Consumer Electronics	<a href="http://www.ti.com/consumer-apps">www.ti.com/consumer-apps</a>
Energy and Lighting	<a href="http://www.ti.com/energy">www.ti.com/energy</a>
Industrial	<a href="http://www.ti.com/industrial">www.ti.com/industrial</a>
Medical	<a href="http://www.ti.com/medical">www.ti.com/medical</a>
Security	<a href="http://www.ti.com/security">www.ti.com/security</a>
Space, Avionics and Defense	<a href="http://www.ti.com/space-avionics-defense">www.ti.com/space-avionics-defense</a>
Video and Imaging	<a href="http://www.ti.com/video">www.ti.com/video</a>

### TI E2E Community

[e2e.ti.com](http://e2e.ti.com)