

MCP809/MCP810 3-Pin Microprocessor Reset Circuits

 Check for Samples: [MCP809](#), [MCP810](#)

FEATURES

- Precise Monitoring of 3V, 3.3V, and 5V Supply Voltages
- Fully specified over temperature
- 140ms min. Power-On Reset Pulse Width, 240ms Typical
 - Active-low $\overline{\text{RESET}}$ Output (MCP809)
 - Active-high RESET Output (MCP810)
- Specified RESET Output Valid for $V_{CC} \geq 1V$
- Low Supply Current, 15 μA typical
- Power supply transient immunity

APPLICATIONS

- Microprocessor Systems
- Computers
- Controllers
- Intelligent Instruments
- Portable/Battery-Powered Equipment
- Automotive

Typical Application Circuit

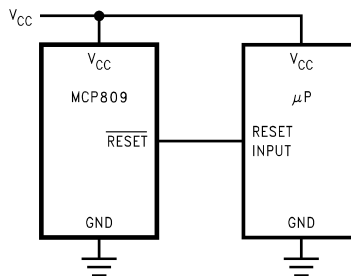

Figure 1. Typical Application Circuit

Connection Diagram

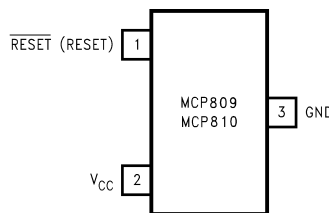

Figure 2. () are for MCP810

DESCRIPTION

The MCP809/810 microprocessor supervisory circuits can be used to monitor the power supplies in microprocessor and digital systems. They provide a reset to the microprocessor during power-up, power-down and brown-out conditions.

The function of the MCP809/810 is to monitor the V_{CC} supply voltage, and assert a reset signal whenever this voltage declines below the factory-programmed reset threshold. The reset signal remains asserted for 240ms after V_{CC} rises above the threshold. The MCP809 has an active-low $\overline{\text{RESET}}$ output, while the MCP810 has an active-high RESET output.

Seven standard reset voltage options are available, suitable for monitoring 5V, 3.3V, and 3V supply voltages.

With a low supply current of only 15 μA , the MCP809/810 are ideal for use in portable equipment. The MCP809/MCP810 are available in the 3-pin SOT23 package.



Please be aware that an important notice concerning availability, standard warranty, and use in critical applications of Texas Instruments semiconductor products and disclaimers thereto appears at the end of this data sheet.

All trademarks are the property of their respective owners.

Pin Description

| PIN | NAME | FUNCTION |
|-----|------------------------------------|---|
| 3 | GND | Ground reference |
| 1 | $\overline{\text{RESET}}$ (MCP809) | Active-low output. $\overline{\text{RESET}}$ remains low while V_{CC} is below the reset threshold, and for 240ms after V_{CC} rises above the reset threshold. |
| | RESET (MCP810) | Active-high output. RESET remains high while V_{CC} is below the reset threshold, and for 240ms after V_{CC} rises above the reset threshold. |
| 2 | V_{CC} | Supply Voltage (+5V, +3.3V, or +3.0V) |



These devices have limited built-in ESD protection. The leads should be shorted together or the device placed in conductive foam during storage or handling to prevent electrostatic damage to the MOS gates.

Absolute Maximum Ratings ⁽¹⁾

| | |
|--|------------------------------|
| V_{CC} | -0.3V to 6.0V |
| RESET, $\overline{\text{RESET}}$ | -0.3V to ($V_{CC} + 0.3V$) |
| Input Current, V_{CC} Pin | 20mA |
| Output Current, RESET, $\overline{\text{RESET}}$ Pin | 20mA |
| Rate of Rise, V_{CC} | 100V/ μ s |
| ESD Rating ⁽²⁾ | 2kV |
| Continuous Power Dissipation ($T_A = +70^\circ\text{C}$) | |
| SOT-23 ⁽³⁾ | 320mW |
| Ambient Temperature Range | -40°C to +105°C |
| Maximum Junction Temperature | 125°C |
| Storage Temperature Range | -65°C to +160°C |
| Lead Temperature (soldering, 10sec) | +300°C |

(1) Absolute Maximum Ratings are limits beyond which damage to the device may occur. Operating Ratings are conditions under which the device operates correctly. Operating ratings do not imply specified performance limits. For specified performance limits and associated test conditions, see the Electrical Characteristics.

(2) The human body model is a 100pF capacitor discharged through a 1.5k Ω resistor into each pin.

(3) Production testing done at $T_A = +25^\circ\text{C}$, over temperature limits specified by design only.

Electrical Characteristics

V_{CC} = full range, T_A = -40°C to $+105^{\circ}\text{C}$, unless otherwise noted. Typical values are at T_A = $+25^{\circ}\text{C}$, V_{CC} = 5V for 4.63/4.38/4.00 versions, V_{CC} = 3.3V for 3.08/2.93 versions, and V_{CC} = 3V for 2.63 version. ⁽¹⁾

| Symbol | Parameter | Conditions | Min | Typ | Max | Units | | | |
|----------|--------------------------------|---|---|---|------|---------------|---|-----|-------------------------|
| | V_{CC} Range | T_A = 0°C to $+70^{\circ}\text{C}$ | 1.0 | | 5.5 | V | | | |
| | | T_A = -40°C to $+105^{\circ}\text{C}$ | 1.2 | | 5.5 | | | | |
| I_{CC} | Supply Current | T_A = -40°C to $+85^{\circ}\text{C}$ | V_{CC} < 5.5V, MCP8__ - 4.63/4.38/4.00 | 18 | 60 | μA | | | |
| | | | V_{CC} < 3.6V, MCP8__ - 3.08/2.93/2.63 | 15 | 50 | | | | |
| | | T_A = $+85^{\circ}\text{C}$ to $+105^{\circ}\text{C}$ | V_{CC} < 5.5V, MCP8__ - 4.63/4.38/4.00 | | 100 | | | | |
| | | | V_{CC} < 3.6V, MCP8__ - 3.08/2.93/2.63 | | 100 | | | | |
| V_{TH} | Reset Threshold ⁽²⁾ | MCP8__ -4.63 | T_A = $+25^{\circ}\text{C}$ | 4.56 | 4.63 | 4.70 | V | | |
| | | | T_A = -40°C to $+85^{\circ}\text{C}$ | 4.50 | | 4.75 | | | |
| | | | T_A = $+85^{\circ}\text{C}$ to $+105^{\circ}\text{C}$ | 4.40 | | 4.86 | | | |
| | | MCP8__ -4.38 | T_A = $+25^{\circ}\text{C}$ | 4.31 | 4.38 | 4.45 | | | |
| | | | T_A = -40°C to $+85^{\circ}\text{C}$ | 4.25 | | 4.50 | | | |
| | | | T_A = $+85^{\circ}\text{C}$ to $+105^{\circ}\text{C}$ | 4.16 | | 4.56 | | | |
| | | MCP8__ -4.00 | T_A = $+25^{\circ}\text{C}$ | 3.93 | 4.00 | 4.06 | | | |
| | | | T_A = -40°C to $+85^{\circ}\text{C}$ | 3.89 | | 4.10 | | | |
| | | | T_A = $+85^{\circ}\text{C}$ to $+105^{\circ}\text{C}$ | 3.80 | | 4.20 | | | |
| | | MCP8__ -3.08 | T_A = $+25^{\circ}\text{C}$ | 3.04 | 3.08 | 3.11 | | | |
| | | | T_A = -40°C to $+85^{\circ}\text{C}$ | 3.00 | | 3.15 | | | |
| | | | T_A = $+85^{\circ}\text{C}$ to $+105^{\circ}\text{C}$ | 2.92 | | 3.23 | | | |
| | | MCP8__ -2.93 | T_A = $+25^{\circ}\text{C}$ | 2.89 | 2.93 | 2.96 | | | |
| | | | T_A = -40°C to $+85^{\circ}\text{C}$ | 2.85 | | 3.00 | | | |
| | | | T_A = $+85^{\circ}\text{C}$ to $+105^{\circ}\text{C}$ | 2.78 | | 3.08 | | | |
| | | MCP8__ -2.63 | T_A = $+25^{\circ}\text{C}$ | 2.59 | 2.63 | 2.66 | | | |
| | | | T_A = -40°C to $+85^{\circ}\text{C}$ | 2.55 | | 2.70 | | | |
| | | | T_A = $+85^{\circ}\text{C}$ to $+105^{\circ}\text{C}$ | 2.50 | | 2.76 | | | |
| | | | Reset Threshold Temperature Coefficient | | | 30 | | | ppm/ $^{\circ}\text{C}$ |
| | | | V_{CC} to Reset Delay ⁽²⁾ | $V_{CC} = V_{TH}$ to $(V_{TH} - 100\text{mV})$ | | 20 | | | μs |
| | | | Reset Active Timeout Period | T_A = -40°C to $+85^{\circ}\text{C}$ | 140 | 240 | | 560 | ms |
| | | | | T_A = $+85^{\circ}\text{C}$ to $+105^{\circ}\text{C}$ | 100 | | | 840 | |

(1) At elevated temperatures, devices must be derated based on package thermal resistance. The device in the SOT23-3 package must be derated at 4mW/ $^{\circ}\text{C}$ at ambient temperatures above 70°C . The device has internal thermal protection.

(2) RESET Output for MCP809, RESETE output for MCP810.

Electrical Characteristics (continued)

V_{CC} = full range, T_A = -40°C to $+105^{\circ}\text{C}$, unless otherwise noted. Typical values are at T_A = $+25^{\circ}\text{C}$, V_{CC} = 5V for 4.63/4.38/4.00 versions, V_{CC} = 3.3V for 3.08/2.93 versions, and V_{CC} = 3V for 2.63 version. ⁽¹⁾

| Symbol | Parameter | Conditions | Min | Typ | Max | Units |
|----------|--|--|--------------|-----|-----|-------|
| V_{OL} | $\overline{\text{RESET}}$ Output Voltage Low (MCP809) | $V_{CC} = V_{TH \text{ min}}$, $I_{SINK} = 1.2\text{mA}$, MCP809-2.63/2.93/3.08 | | | 0.3 | V |
| | | $V_{CC} = V_{TH \text{ min}}$, $I_{SINK} = 3.2\text{mA}$, MCP809-4.63/4.38/4.00 | | | 0.4 | |
| | | $V_{CC} > 1.0\text{V}$, $I_{SINK} = 50\mu\text{A}$ | | | 0.3 | |
| V_{OH} | $\overline{\text{RESET}}$ Output Voltage High (MCP809) | $V_{CC} > V_{TH \text{ max}}$, $I_{SOURCE} = 500\mu\text{A}$, MCP809-2.63/2.93/3.08 | $0.8V_{CC}$ | | | V |
| | | $V_{CC} > V_{TH \text{ max}}$, $I_{SOURCE} = 800\mu\text{A}$, MCP809-4.63/4.38/4.00 | $V_{CC}-1.5$ | | | |
| V_{OL} | RESET Output Voltage Low (MCP810) | $V_{CC} = V_{TH \text{ max}}$, $I_{SINK} = 1.2\text{mA}$, MCP810-2.63/2.93/3.08 | | | 0.3 | V |
| | | $V_{CC} = V_{TH \text{ max}}$, $I_{SINK} = 3.2\text{mA}$, MCP810-4.63/4.38/4.00 | | | 0.4 | |
| V_{OH} | RESET Output Voltage High (MCP810) | $1.8\text{V} < V_{CC} < V_{TH \text{ min}}$, $I_{SOURCE} = 150\mu\text{A}$ | $0.8V_{CC}$ | | | V |

TYPICAL PERFORMANCE CHARACTERISTICS

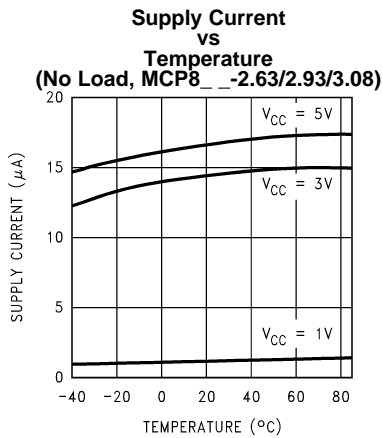

Figure 3.

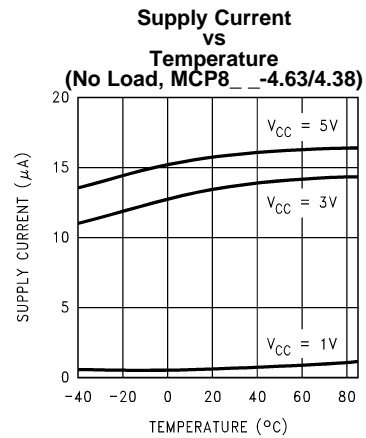

Figure 4.

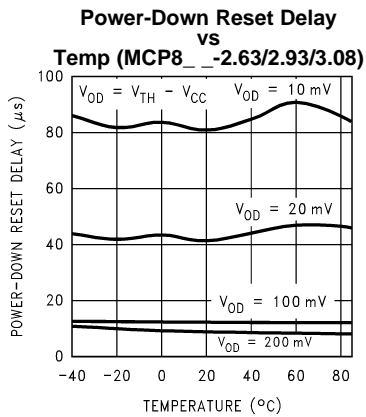

Figure 5.

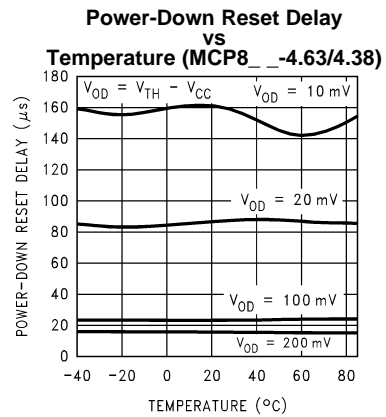

Figure 6.

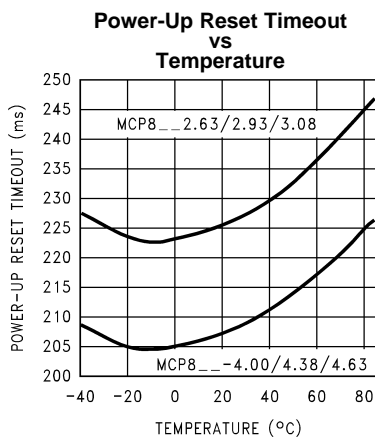

Figure 7.

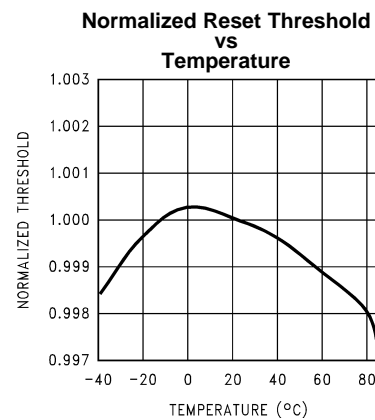

Figure 8.

APPLICATION INFORMATION

Benefits of Precision Reset Thresholds

A microprocessor supply supervisor must provide a reset output within a predictable range of the supply voltage. A common threshold range is between 5% and 10% below the nominal supply voltage. The 4.63V and 3.08V options of the MCP809/810 use highly accurate circuitry to ensure that the reset threshold occurs only within this range (for 5V and 3.3V supplies). The other voltage options have the same tight tolerance to ensure a reset signal for other narrow monitor ranges. See [Table 1](#) for examples of how the standard reset thresholds apply to 3V, 3.3V, and 5V nominal supply voltages.

Table 1. Reset Thresholds Related to Common Supply Voltages

| Reset Threshold | 3.0V | 3.3V | 5.0V |
|-----------------|----------|----------|----------|
| 4.63 ± 3% | | | 90 - 95% |
| 4.38 ± 3% | | | 85 - 90% |
| 4.00 ± 3% | | | 78 - 82% |
| 3.08 ± 3% | | 90 - 95% | |
| 2.93 ± 3% | | 86 - 90% | |
| 2.63 ± 3% | 85 - 90% | 77 - 81% | |

Ensuring a Valid Reset Output Down to $V_{CC} = 0V$

When V_{CC} falls below 1V, the MCP809 $\overline{\text{RESET}}$ output no longer sinks current. A high-impedance CMOS logic input connected to $\overline{\text{RESET}}$ can therefore drift to undetermined voltages. To prevent this situation, a 100k Ω resistor should be connected from the $\overline{\text{RESET}}$ output to ground, as shown in [Figure 9](#).

A 100k Ω pull-up resistor to V_{CC} is also recommended for the MCP810, if $\overline{\text{RESET}}$ is required to remain valid for $V_{CC} < 1V$.

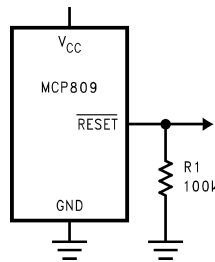

Figure 9. $\overline{\text{RESET}}$ Valid to $V_{CC} = \text{Ground}$ Circuit

Negative-Going V_{CC} Transients

The MCP809/810 are relatively immune to short negative-going transients or glitches on V_{CC} . [Figure 10](#) shows the maximum pulse width a negative-going V_{CC} transient can have without causing a reset pulse. In general, as the magnitude of the transient increases, going further below the threshold, the maximum allowable pulse width decreases. Typically, for the 4.63V and 4.38V version of the MCP809/810, a V_{CC} transient that goes 100mV below the reset threshold and lasts 20 μs or less will not cause a reset pulse. A 0.1 μF bypass capacitor mounted as close as possible to the V_{CC} pin will provide additional transient rejection.

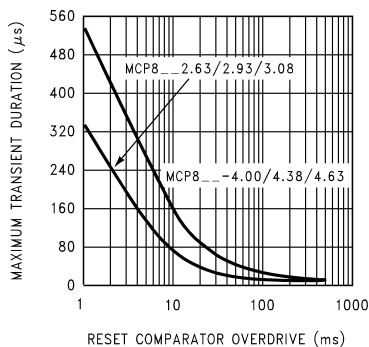

Figure 10. Maximum Transient Duration without Causing a Reset Pulse vs. Reset Comparator Overdrive

Interfacing to μ Ps with Bidirectional Reset Pins

Microprocessors with bidirectional reset pins, such as the Motorola 68HC11 series, can be connected to the MCP809 $\overline{\text{RESET}}$ output. To ensure a correct output on the MCP809 even when the microprocessor reset pin is in the opposite state, connect a 4.7k Ω resistor between the MCP809 $\overline{\text{RESET}}$ output and the μ P reset pin, as shown in Figure 11. Buffer the MCP809 $\overline{\text{RESET}}$ output to other system components.

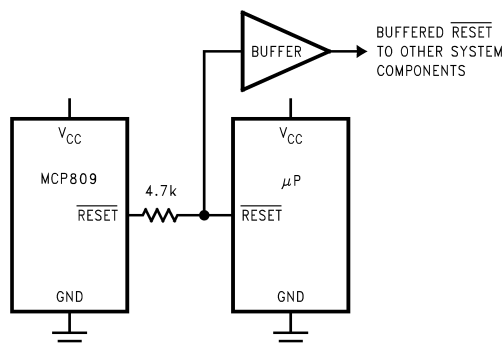

Figure 11. Interfacing to Microprocessors with Bidirectional Reset I/O

REVISION HISTORY

| Changes from Original (May 2013) to Revision A | Page |
|--|-------------------|
| • Changed layout of National Data Sheet to TI format | 7 |

PACKAGING INFORMATION

| Orderable Device | Status (1) | Package Type | Package Drawing | Pins | Package Qty | Eco Plan (2) | Lead/Ball Finish | MSL Peak Temp (3) | Op Temp (°C) | Top-Side Markings (4) | Samples |
|--------------------|---------------|--------------|-----------------|------|-------------|-------------------------|------------------|----------------------|--------------|--------------------------|-------------------------|
| MCP809M3-2.93 | ACTIVE | SOT-23 | DBZ | 3 | 1000 | TBD | Call TI | Call TI | -40 to 105 | SRB | Samples |
| MCP809M3-2.93/NOPB | ACTIVE | SOT-23 | DBZ | 3 | 1000 | Green (RoHS & no Sb/Br) | CU SN | Level-1-260C-UNLIM | -40 to 105 | SRB | Samples |

(1) The marketing status values are defined as follows:

ACTIVE: Product device recommended for new designs.

LIFEBUY: TI has announced that the device will be discontinued, and a lifetime-buy period is in effect.

NRND: Not recommended for new designs. Device is in production to support existing customers, but TI does not recommend using this part in a new design.

PREVIEW: Device has been announced but is not in production. Samples may or may not be available.

OBSOLETE: TI has discontinued the production of the device.

(2) Eco Plan - The planned eco-friendly classification: Pb-Free (RoHS), Pb-Free (RoHS Exempt), or Green (RoHS & no Sb/Br) - please check <http://www.ti.com/productcontent> for the latest availability information and additional product content details.

TBD: The Pb-Free/Green conversion plan has not been defined.

Pb-Free (RoHS): TI's terms "Lead-Free" or "Pb-Free" mean semiconductor products that are compatible with the current RoHS requirements for all 6 substances, including the requirement that lead not exceed 0.1% by weight in homogeneous materials. Where designed to be soldered at high temperatures, TI Pb-Free products are suitable for use in specified lead-free processes.

Pb-Free (RoHS Exempt): This component has a RoHS exemption for either 1) lead-based flip-chip solder bumps used between the die and package, or 2) lead-based die adhesive used between the die and leadframe. The component is otherwise considered Pb-Free (RoHS compatible) as defined above.

Green (RoHS & no Sb/Br): TI defines "Green" to mean Pb-Free (RoHS compatible), and free of Bromine (Br) and Antimony (Sb) based flame retardants (Br or Sb do not exceed 0.1% by weight in homogeneous material)

(3) MSL, Peak Temp. -- The Moisture Sensitivity Level rating according to the JEDEC industry standard classifications, and peak solder temperature.

(4) Multiple Top-Side Markings will be inside parentheses. Only one Top-Side Marking contained in parentheses and separated by a "~" will appear on a device. If a line is indented then it is a continuation of the previous line and the two combined represent the entire Top-Side Marking for that device.

Important Information and Disclaimer: The information provided on this page represents TI's knowledge and belief as of the date that it is provided. TI bases its knowledge and belief on information provided by third parties, and makes no representation or warranty as to the accuracy of such information. Efforts are underway to better integrate information from third parties. TI has taken and continues to take reasonable steps to provide representative and accurate information but may not have conducted destructive testing or chemical analysis on incoming materials and chemicals. TI and TI suppliers consider certain information to be proprietary, and thus CAS numbers and other limited information may not be available for release.

In no event shall TI's liability arising out of such information exceed the total purchase price of the TI part(s) at issue in this document sold by TI to Customer on an annual basis.

TAPE AND REEL INFORMATION

QUADRANT ASSIGNMENTS FOR PIN 1 ORIENTATION IN TAPE

*All dimensions are nominal

| Device | Package Type | Package Drawing | Pins | SPQ | Reel Diameter (mm) | Reel Width W1 (mm) | A0 (mm) | B0 (mm) | K0 (mm) | P1 (mm) | W (mm) | Pin1 Quadrant |
|--------------------|--------------|-----------------|------|------|--------------------|--------------------|---------|---------|---------|---------|--------|---------------|
| MCP809M3-2.93 | SOT-23 | DBZ | 3 | 1000 | 178.0 | 8.4 | 3.3 | 2.9 | 1.22 | 4.0 | 8.0 | Q3 |
| MCP809M3-2.93/NOPB | SOT-23 | DBZ | 3 | 1000 | 178.0 | 8.4 | 3.3 | 2.9 | 1.22 | 4.0 | 8.0 | Q3 |

TAPE AND REEL BOX DIMENSIONS



*All dimensions are nominal

| Device | Package Type | Package Drawing | Pins | SPQ | Length (mm) | Width (mm) | Height (mm) |
|--------------------|--------------|-----------------|------|------|-------------|------------|-------------|
| MCP809M3-2.93 | SOT-23 | DBZ | 3 | 1000 | 210.0 | 185.0 | 35.0 |
| MCP809M3-2.93/NOPB | SOT-23 | DBZ | 3 | 1000 | 210.0 | 185.0 | 35.0 |

DBZ (R-PDSO-G3)

PLASTIC SMALL-OUTLINE



- NOTES:
- A. All linear dimensions are in millimeters. Dimensioning and tolerancing per ASME Y14.5M-1994.
 - B. This drawing is subject to change without notice.
 - C. Lead dimensions are inclusive of plating.
 - D. Body dimensions are exclusive of mold flash and protrusion. Mold flash and protrusion not to exceed 0.25 per side.
 - E. Falls within JEDEC TO-236 variation AB, except minimum foot length.

IMPORTANT NOTICE

Texas Instruments Incorporated and its subsidiaries (TI) reserve the right to make corrections, enhancements, improvements and other changes to its semiconductor products and services per JESD46, latest issue, and to discontinue any product or service per JESD48, latest issue. Buyers should obtain the latest relevant information before placing orders and should verify that such information is current and complete. All semiconductor products (also referred to herein as "components") are sold subject to TI's terms and conditions of sale supplied at the time of order acknowledgment.

TI warrants performance of its components to the specifications applicable at the time of sale, in accordance with the warranty in TI's terms and conditions of sale of semiconductor products. Testing and other quality control techniques are used to the extent TI deems necessary to support this warranty. Except where mandated by applicable law, testing of all parameters of each component is not necessarily performed.

TI assumes no liability for applications assistance or the design of Buyers' products. Buyers are responsible for their products and applications using TI components. To minimize the risks associated with Buyers' products and applications, Buyers should provide adequate design and operating safeguards.

TI does not warrant or represent that any license, either express or implied, is granted under any patent right, copyright, mask work right, or other intellectual property right relating to any combination, machine, or process in which TI components or services are used. Information published by TI regarding third-party products or services does not constitute a license to use such products or services or a warranty or endorsement thereof. Use of such information may require a license from a third party under the patents or other intellectual property of the third party, or a license from TI under the patents or other intellectual property of TI.

Reproduction of significant portions of TI information in TI data books or data sheets is permissible only if reproduction is without alteration and is accompanied by all associated warranties, conditions, limitations, and notices. TI is not responsible or liable for such altered documentation. Information of third parties may be subject to additional restrictions.

Resale of TI components or services with statements different from or beyond the parameters stated by TI for that component or service voids all express and any implied warranties for the associated TI component or service and is an unfair and deceptive business practice. TI is not responsible or liable for any such statements.

Buyer acknowledges and agrees that it is solely responsible for compliance with all legal, regulatory and safety-related requirements concerning its products, and any use of TI components in its applications, notwithstanding any applications-related information or support that may be provided by TI. Buyer represents and agrees that it has all the necessary expertise to create and implement safeguards which anticipate dangerous consequences of failures, monitor failures and their consequences, lessen the likelihood of failures that might cause harm and take appropriate remedial actions. Buyer will fully indemnify TI and its representatives against any damages arising out of the use of any TI components in safety-critical applications.

In some cases, TI components may be promoted specifically to facilitate safety-related applications. With such components, TI's goal is to help enable customers to design and create their own end-product solutions that meet applicable functional safety standards and requirements. Nonetheless, such components are subject to these terms.

No TI components are authorized for use in FDA Class III (or similar life-critical medical equipment) unless authorized officers of the parties have executed a special agreement specifically governing such use.

Only those TI components which TI has specifically designated as military grade or "enhanced plastic" are designed and intended for use in military/aerospace applications or environments. Buyer acknowledges and agrees that any military or aerospace use of TI components which have **not** been so designated is solely at the Buyer's risk, and that Buyer is solely responsible for compliance with all legal and regulatory requirements in connection with such use.

TI has specifically designated certain components as meeting ISO/TS16949 requirements, mainly for automotive use. In any case of use of non-designated products, TI will not be responsible for any failure to meet ISO/TS16949.

Products

| | |
|------------------------------|--|
| Audio | www.ti.com/audio |
| Amplifiers | amplifier.ti.com |
| Data Converters | dataconverter.ti.com |
| DLP® Products | www.dlp.com |
| DSP | dsp.ti.com |
| Clocks and Timers | www.ti.com/clocks |
| Interface | interface.ti.com |
| Logic | logic.ti.com |
| Power Mgmt | power.ti.com |
| Microcontrollers | microcontroller.ti.com |
| RFID | www.ti-rfid.com |
| OMAP Applications Processors | www.ti.com/omap |
| Wireless Connectivity | www.ti.com/wirelessconnectivity |

Applications

| | |
|-------------------------------|--|
| Automotive and Transportation | www.ti.com/automotive |
| Communications and Telecom | www.ti.com/communications |
| Computers and Peripherals | www.ti.com/computers |
| Consumer Electronics | www.ti.com/consumer-apps |
| Energy and Lighting | www.ti.com/energy |
| Industrial | www.ti.com/industrial |
| Medical | www.ti.com/medical |
| Security | www.ti.com/security |
| Space, Avionics and Defense | www.ti.com/space-avionics-defense |
| Video and Imaging | www.ti.com/video |

TI E2E Community

e2e.ti.com