

High-Speed FET-INPUT OPERATIONAL AMPLIFIERS

FEATURES

- **FET INPUT:** $I_B = 50\text{pA max}$
- **WIDE BANDWIDTH:** 8MHz
- **HIGH SLEW RATE:** 20V/ μs
- **LOW NOISE:** 8nV/ $\sqrt{\text{Hz}}$ (1kHz)
- **LOW DISTORTION:** 0.00008%
- **HIGH OPEN-LOOP GAIN:** 130dB (600 Ω load)
- **WIDE SUPPLY RANGE:** ± 2.5 to $\pm 18\text{V}$
- **LOW OFFSET VOLTAGE:** 500 $\mu\text{V max}$
- **SINGLE, DUAL, AND QUAD VERSIONS**

DESCRIPTION

The OPA132 series of FET-input op amps provides high-speed and excellent dc performance. The combination of high slew rate and wide bandwidth provide fast settling time. Single, dual, and quad versions have identical specifications for maximum design flexibility. High performance grades are available in the single and dual versions. All are ideal for general-purpose, audio, data acquisition and communications applications, especially where high source impedance is encountered.

OPA132 op amps are easy to use and free from phase inversion and overload problems often found in common FET-input op amps. Input cascode circuitry provides excellent common-mode rejection and maintains low input bias current over its wide input voltage range. OPA132 series op amps are stable in unity gain and provide excellent dynamic behavior over a wide range of load conditions, including high load capacitance. Dual and quad versions feature completely independent circuitry for lowest crosstalk and freedom from interaction, even when overdriven or overloaded.

Single and dual versions are available in 8-pin DIP and SO-8 surface-mount packages. Quad is available in 14-pin DIP and SO-14 surface-mount packages. All are specified for -40°C to $+85^\circ\text{C}$ operation.

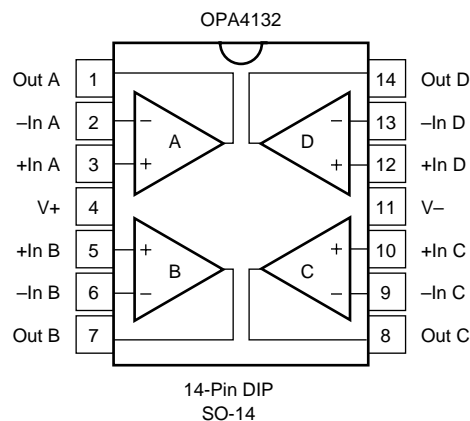
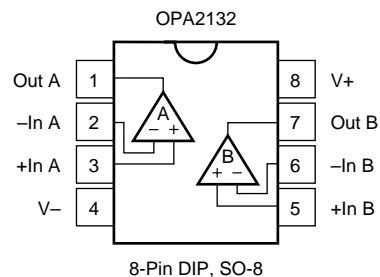
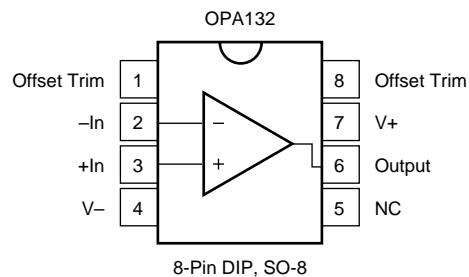

Please be aware that an important notice concerning availability, standard warranty, and use in critical applications of Texas Instruments semiconductor products and disclaimers thereto appears at the end of this data sheet.

All trademarks are the property of their respective owners.

ABSOLUTE MAXIMUM RATINGS

Supply Voltage, V+ to V-	36V
Input Voltage	(V-) -0.7V to (V+) +0.7V
Output Short-Circuit ⁽¹⁾	Continuous
Operating Temperature	-40°C to +125°C
Storage Temperature	-55°C to +125°C
Junction Temperature	150°C
Lead Temperature (soldering, 10s)	300°C

NOTE: (1) Short-circuit to ground, one amplifier per package.

PACKAGE/ORDERING INFORMATION

For the most current package and ordering information, see the Package Option Addendum located at the end of this data sheet.



ELECTROSTATIC DISCHARGE SENSITIVITY

This integrated circuit can be damaged by ESD. Texas Instruments recommends that all integrated circuits be handled with appropriate precautions. Failure to observe proper handling and installation procedures can cause damage.

ESD damage can range from subtle performance degradation to complete device failure. Precision integrated circuits may be more susceptible to damage because very small parametric changes could cause the device not to meet its published specifications.

SPECIFICATIONS

At $T_A = +25^\circ\text{C}$, $V_S = \pm 15\text{V}$, unless otherwise noted.

PARAMETER	CONDITION	OPA132P, U OPA2132P, U			OPA132PA, UA OPA2132PA, UA OPA4132PA, UA			UNITS	
		MIN	TYP	MAX	MIN	TYP	MAX		
OFFSET VOLTAGE Input Offset Voltage vs Temperature ⁽¹⁾ vs Power Supply Channel Separation (dual and quad)	Operating Temperature Range $V_S = \pm 2.5\text{V to } \pm 18\text{V}$ $R_L = 2\text{k}\Omega$		± 0.25	± 0.5		± 0.5	± 2	mV $\mu\text{V}/^\circ\text{C}$ $\mu\text{V}/\text{V}$ $\mu\text{V}/\text{V}$	
INPUT BIAS CURRENT Input Bias Current ⁽²⁾ vs Temperature Input Offset Current ⁽²⁾		$V_{CM} = 0\text{V}$		+5 See Typical Curve	± 50		*	*	pA
		$V_{CM} = 0\text{V}$		± 2	± 50		*	*	pA
NOISE Input Voltage Noise Noise Density, $f = 10\text{Hz}$ $f = 100\text{Hz}$ $f = 1\text{kHz}$ $f = 10\text{kHz}$ Current Noise Density, $f = 1\text{kHz}$				23 10 8 8 3			*	*	$\text{nV}/\sqrt{\text{Hz}}$ $\text{nV}/\sqrt{\text{Hz}}$ $\text{nV}/\sqrt{\text{Hz}}$ $\text{nV}/\sqrt{\text{Hz}}$ $\text{fA}/\sqrt{\text{Hz}}$
INPUT VOLTAGE RANGE Common-Mode Voltage Range Common-Mode Rejection	$V_{CM} = -12.5\text{V to } +12.5\text{V}$	(V-) +2.5 96	± 13 100	(V+) -2.5	*	*	*	V dB	
INPUT IMPEDANCE Differential Common-Mode	$V_{CM} = -12.5\text{V to } +12.5\text{V}$		$10^{13} \parallel 2$ $10^{13} \parallel 6$			*	*	$\Omega \parallel \text{pF}$ $\Omega \parallel \text{pF}$	
OPEN-LOOP GAIN Open-Loop Voltage Gain	$R_L = 10\text{k}\Omega$, $V_O = -14.5\text{V to } +13.8\text{V}$ $R_L = 2\text{k}\Omega$, $V_O = -13.8\text{V to } +13.5\text{V}$ $R_L = 600\Omega$, $V_O = -12.8\text{V to } +12.5\text{V}$	110 110 110	120 126 130		104 104 104	*	*	dB dB dB	
FREQUENCY RESPONSE Gain-Bandwidth Product Slew Rate Settling Time: 0.1% 0.01% Overload Recovery Time Total Harmonic Distortion + Noise	$G = -1$, 10V Step, $C_L = 100\text{pF}$ $G = -1$, 10V Step, $C_L = 100\text{pF}$ $G = \pm 1$ 1kHz, $G = 1$, $V_O = 3.5\text{Vrms}$ $R_L = 2\text{k}\Omega$ $R_L = 600\Omega$		8 ± 20 0.7 1 0.5 0.00008 0.00009			*	*	MHz V/ μs μs μs μs % %	
OUTPUT Voltage Output, Positive Negative Positive Negative Positive Negative Short-Circuit Current Capacitive Load Drive (Stable Operation)		$R_L = 10\text{k}\Omega$ $R_L = 2\text{k}\Omega$ $R_L = 600\Omega$	(V+) -1.2 (V-) +0.5 (V+) -1.5 (V-) +1.2 (V+) -2.5 (V-) +2.2	(V+) -0.9 (V-) +0.3 (V+) -1.2 (V-) +0.9 (V+) -2.0 (V-) +1.9 ± 40		*	*	*	V V V V V V mA
							*	*	
							*	*	
POWER SUPPLY Specified Operating Voltage Operating Voltage Range Quiescent Current (per amplifier)	$I_O = 0$	± 2.5	± 15 ± 4	± 18 ± 4.8	*	*	*	V V mA	
TEMPERATURE RANGE Operating Range Storage Thermal Resistance, θ_{JA} 8-Pin DIP SO-8 Surface-Mount 14-Pin DIP SO-14 Surface-Mount		-40 -40		+85 +125	*	*	*	$^\circ\text{C}$ $^\circ\text{C}$ $^\circ\text{C}/\text{W}$ $^\circ\text{C}/\text{W}$ $^\circ\text{C}/\text{W}$ $^\circ\text{C}/\text{W}$	

* Specifications same as OPA132P, OPA132U.

NOTES: (1) Guaranteed by wafer test. (2) High-speed test at $T_J = 25^\circ\text{C}$.

TYPICAL PERFORMANCE CURVES

At $T_A = +25^\circ\text{C}$, $V_S = \pm 15\text{V}$, $R_L = 2\text{k}\Omega$, unless otherwise noted.

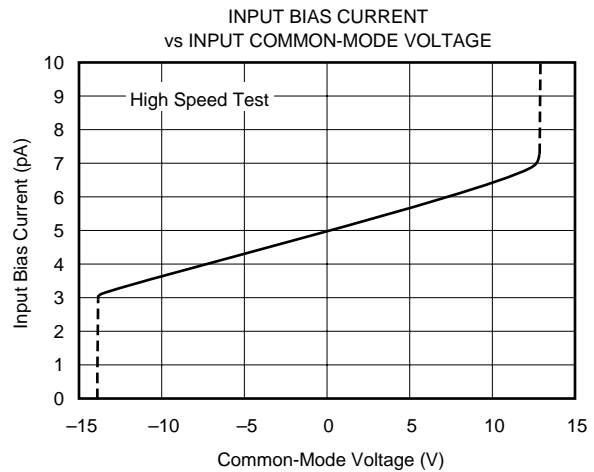
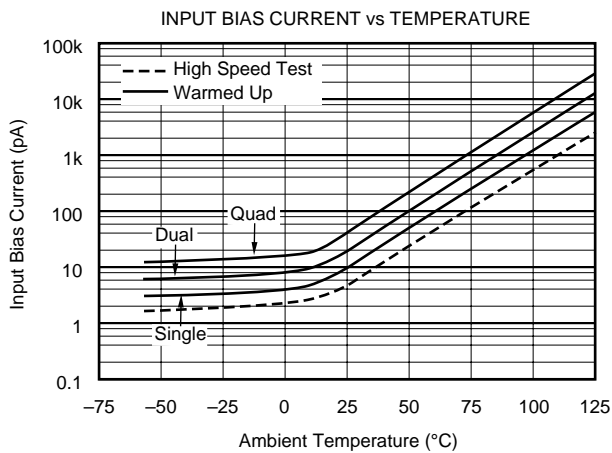
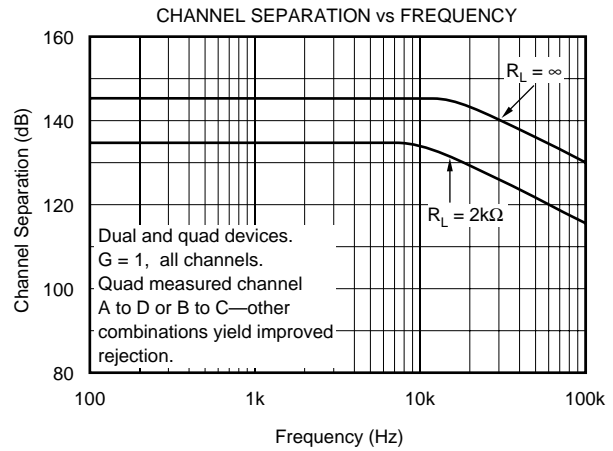
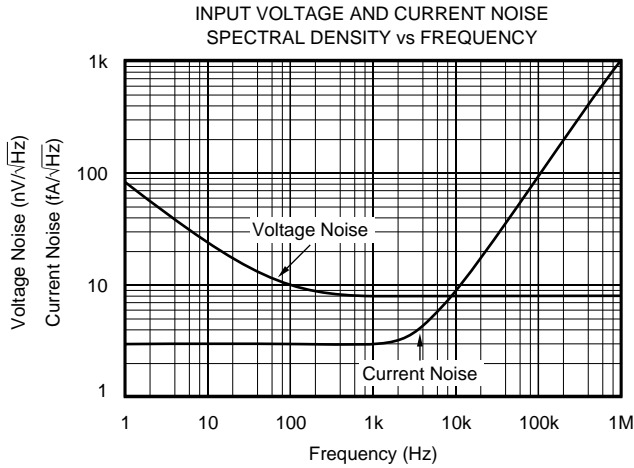
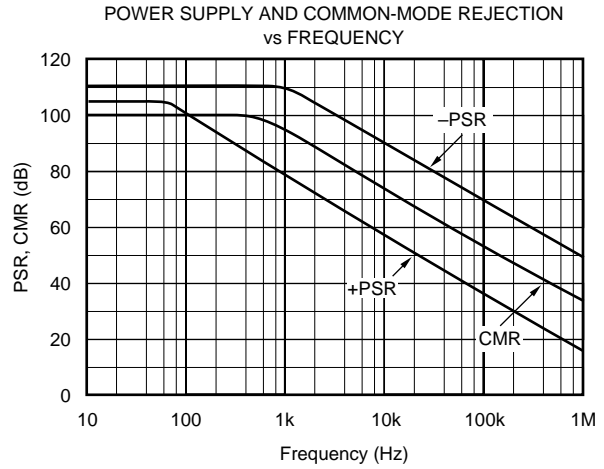
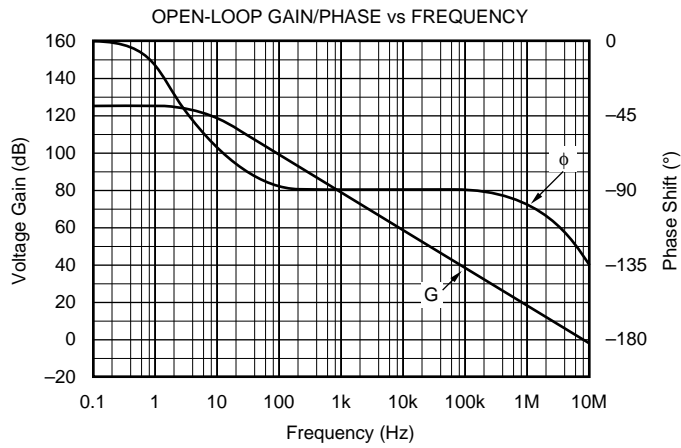

TYPICAL PERFORMANCE CURVES (Cont.)

At $T_A = +25^\circ\text{C}$, $V_S = \pm 15\text{V}$, $R_L = 2\text{k}\Omega$, unless otherwise noted.

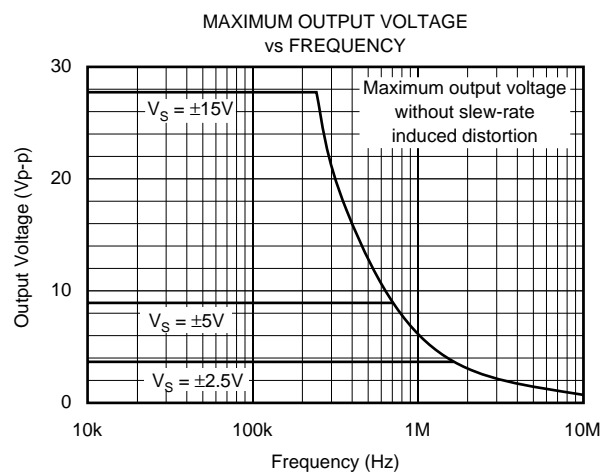
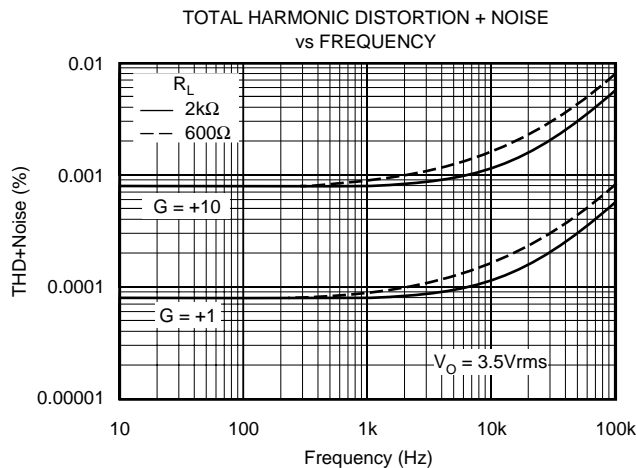
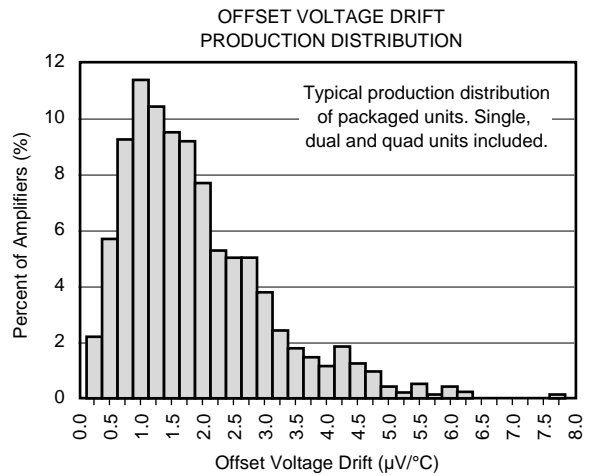
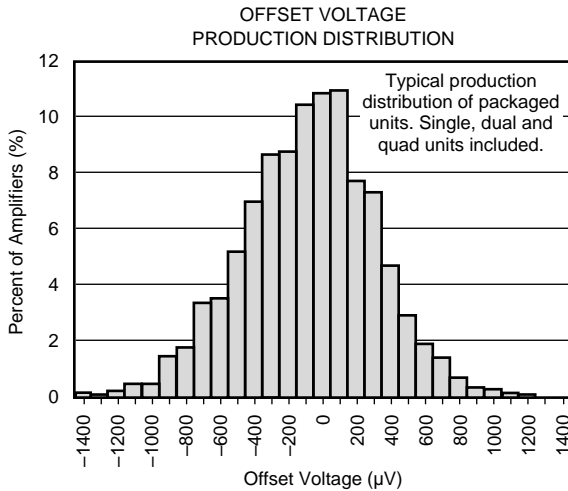
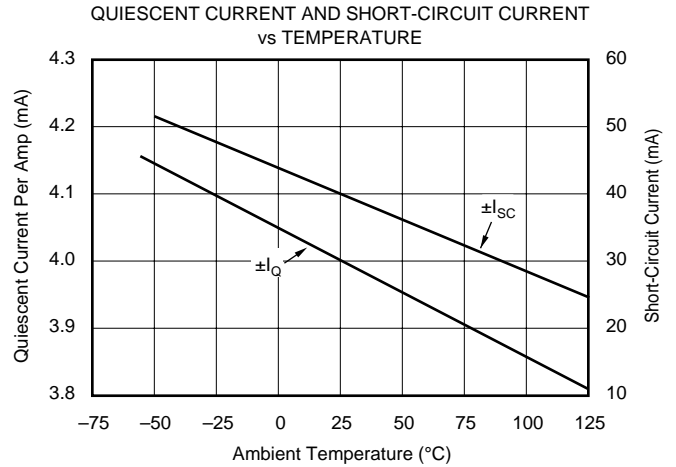
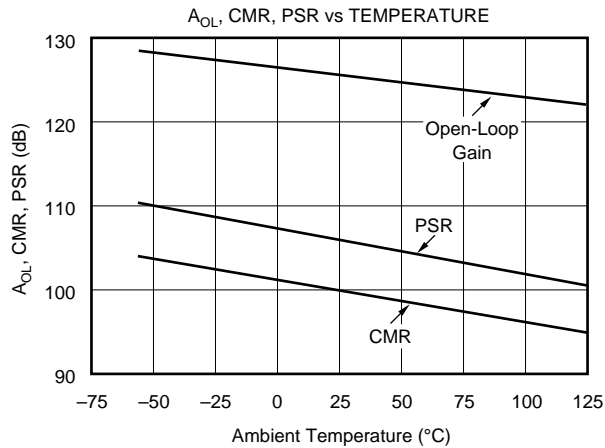

TYPICAL PERFORMANCE CURVES (Cont.)

At $T_A = +25^\circ\text{C}$, $V_S = \pm 15\text{V}$, $R_L = 2\text{k}\Omega$, unless otherwise noted.

SMALL-SIGNAL STEP RESPONSE
 $G = 1$, $C_L = 100\text{pF}$

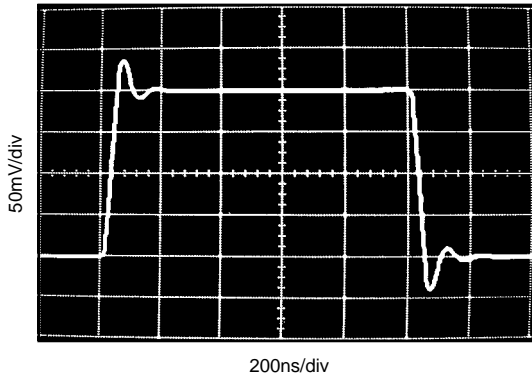

LARGE-SIGNAL STEP RESPONSE
 $G = 1$, $C_L = 100\text{pF}$

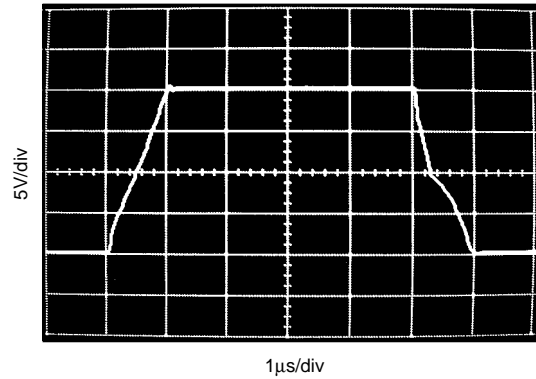

SETTLING TIME vs CLOSED-LOOP GAIN

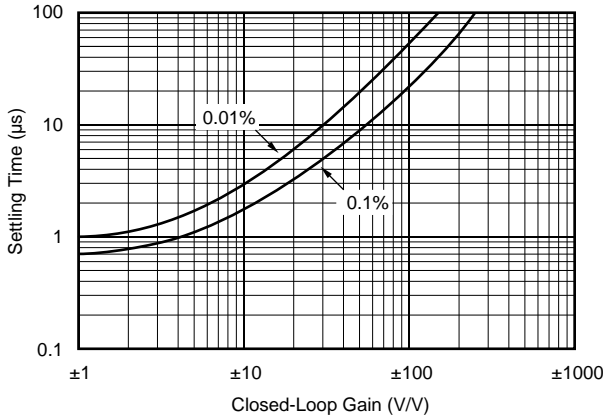

SMALL-SIGNAL OVERSHOOT vs LOAD CAPACITANCE

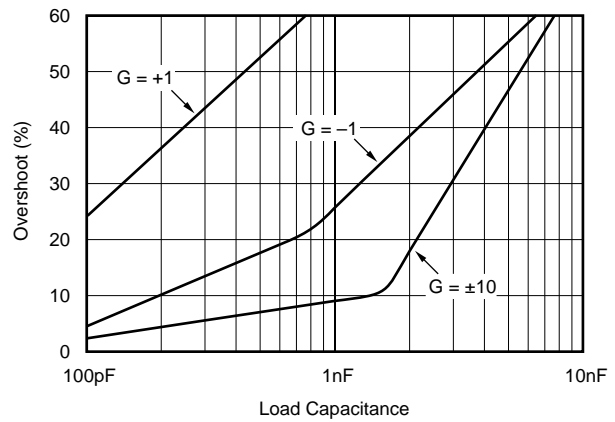

OUTPUT VOLTAGE SWING vs OUTPUT CURRENT

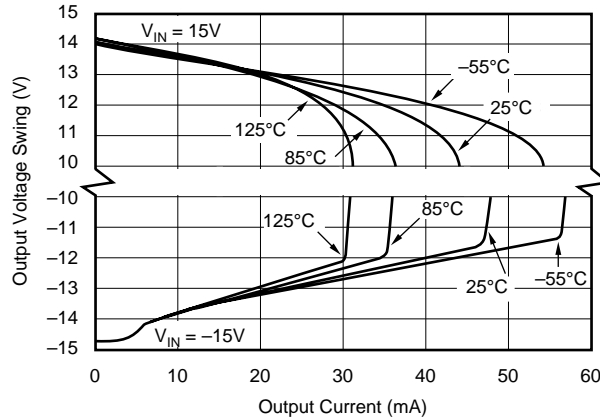

APPLICATIONS INFORMATION

OPA132 series op amps are unity-gain stable and suitable for a wide range of general-purpose applications. Power supply pins should be bypassed with 10nF ceramic capacitors or larger.

OPA132 op amps are free from unexpected output phase-reversal common with FET op amps. Many FET-input op amps exhibit phase-reversal of the output when the input common-mode voltage range is exceeded. This can occur in voltage-follower circuits, causing serious problems in control loop applications. OPA132 series op amps are free from this undesirable behavior. All circuitry is completely independent in dual and quad versions, assuring normal behavior when one amplifier in a package is overdriven or short-circuited.

OPERATING VOLTAGE

OPA132 series op amps operate with power supplies from $\pm 2.5\text{V}$ to $\pm 18\text{V}$ with excellent performance. Although specifications are production tested with $\pm 15\text{V}$ supplies, most behavior remains unchanged throughout the full operating voltage range. Parameters which vary significantly with operating voltage are shown in the typical performance curves.

OFFSET VOLTAGE TRIM

Offset voltage of OPA132 series amplifiers is laser trimmed and usually requires no user adjustment. The OPA132 (single op amp version) provides offset voltage trim connections on pins 1 and 8. Offset voltage can be adjusted by connecting a potentiometer as shown in Figure 1. This adjustment should be used only to null the offset of the op amp, not to adjust system offset or offset produced by the signal source. Nulling offset could degrade the offset voltage drift behavior of the op amp. While it is not possible to predict the exact change in drift, the effect is usually small.

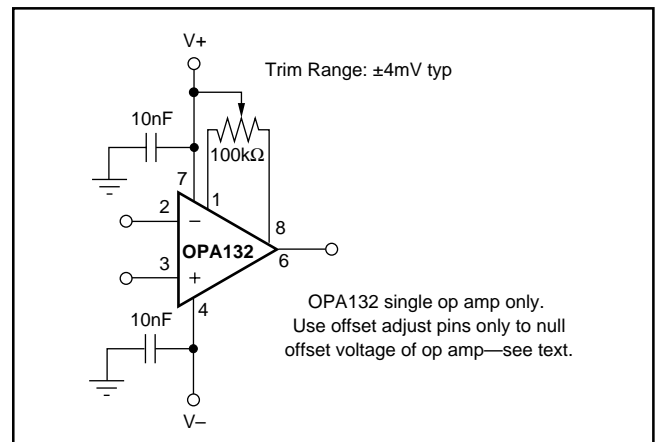

FIGURE 1. OPA132 Offset Voltage Trim Circuit.

INPUT BIAS CURRENT

The FET-inputs of the OPA132 series provide very low input bias current and cause negligible errors in most applications. For applications where low input bias current is crucial, junction temperature rise should be minimized. The input bias current of FET-input op amps increases with temperature as shown in the typical performance curve “Input Bias Current vs Temperature.”

The OPA132 series may be operated at reduced power supply voltage to minimize power dissipation and temperature rise. Using $\pm 3\text{V}$ supplies reduces power dissipation to one-fifth that at $\pm 15\text{V}$.

The dual and quad versions have higher total power dissipation than the single, leading to higher junction temperature. Thus, a warmed-up quad will have higher input bias current than a warmed-up single. Furthermore, an SOIC will generally have higher junction temperature than a DIP at the same ambient temperature because of a larger θ_{JA} . Refer to the specifications table.

Circuit board layout can also help minimize junction temperature rise. Temperature rise can be minimized by soldering the devices to the circuit board rather than using a socket. Wide copper traces will also help dissipate the heat by acting as an additional heat sink.

Input stage cascode circuitry assures that the input bias current remains virtually unchanged throughout the full input common-mode range of the OPA132 series. See the typical performance curve “Input Bias Current vs Common-Mode Voltage.”

PACKAGING INFORMATION

ORDERABLE DEVICE	STATUS(1)	PACKAGE TYPE	PACKAGE DRAWING	PINS	PACKAGE QTY
OPA132P	OBSOLETE	PDIP	P	8	
OPA132P1	OBSOLETE	PDIP	P	8	
OPA132PA	OBSOLETE	PDIP	P	8	
OPA132PA2	OBSOLETE	PDIP	P	8	
OPA132U	ACTIVE	SOIC	D	8	100
OPA132U/2K5	ACTIVE	SOIC	D	8	2500
OPA132U1	OBSOLETE	PDIP	P	8	
OPA132UA	ACTIVE	SOIC	D	8	100
OPA132UA/2K5	ACTIVE	SOIC	D	8	2500
OPA132UA2	OBSOLETE	PDIP	P	8	
OPA2132P	ACTIVE	PDIP	P	8	50
OPA2132PA	ACTIVE	PDIP	P	8	50
OPA2132U	ACTIVE	SOIC	D	8	100
OPA2132U/2K5	ACTIVE	SOIC	D	8	2500
OPA2132UA	ACTIVE	SOIC	D	8	100
OPA2132UA/2K5	ACTIVE	SOIC	D	8	2500
OPA4132PA	OBSOLETE	PDIP	N	14	
OPA4132UA	ACTIVE	SOIC	D	14	58
OPA4132UA/2K5	ACTIVE	SOIC	D	14	2500

(1) The marketing status values are defined as follows:

ACTIVE: Product device recommended for new designs.

LIFEBUY: TI has announced that the device will be discontinued, and a lifetime-buy period is in effect.

NRND: Not recommended for new designs. Device is in production to support existing customers, but TI does not recommend using this part in a new design.

PREVIEW: Device has been announced but is not in production. Samples may or may not be available.

OBSOLETE: TI has discontinued the production of the device.

P (R-PDIP-T8)

PLASTIC DUAL-IN-LINE



- NOTES: A. All linear dimensions are in inches (millimeters).
 B. This drawing is subject to change without notice.
 C. Falls within JEDEC MS-001

For the latest package information, go to http://www.ti.com/sc/docs/package/pkg_info.htm



N (R-PDIP-T**)

PLASTIC DUAL-IN-LINE PACKAGE

16 PINS SHOWN



4040049/E 12/2002

- NOTES:
- A. All linear dimensions are in inches (millimeters).
 - B. This drawing is subject to change without notice.
 - $\triangle C$ Falls within JEDEC MS-001, except 18 and 20 pin minimum body length (Dim A).
 - $\triangle D$ The 20 pin end lead shoulder width is a vendor option, either half or full width.

D (R-PDSO-G**)

PLASTIC SMALL-OUTLINE PACKAGE

8 PINS SHOWN



- NOTES: A. All linear dimensions are in inches (millimeters).
 B. This drawing is subject to change without notice.
 C. Body dimensions do not include mold flash or protrusion, not to exceed 0.006 (0,15).
 D. Falls within JEDEC MS-012

IMPORTANT NOTICE

Texas Instruments Incorporated and its subsidiaries (TI) reserve the right to make corrections, modifications, enhancements, improvements, and other changes to its products and services at any time and to discontinue any product or service without notice. Customers should obtain the latest relevant information before placing orders and should verify that such information is current and complete. All products are sold subject to TI's terms and conditions of sale supplied at the time of order acknowledgment.

TI warrants performance of its hardware products to the specifications applicable at the time of sale in accordance with TI's standard warranty. Testing and other quality control techniques are used to the extent TI deems necessary to support this warranty. Except where mandated by government requirements, testing of all parameters of each product is not necessarily performed.

TI assumes no liability for applications assistance or customer product design. Customers are responsible for their products and applications using TI components. To minimize the risks associated with customer products and applications, customers should provide adequate design and operating safeguards.

TI does not warrant or represent that any license, either express or implied, is granted under any TI patent right, copyright, mask work right, or other TI intellectual property right relating to any combination, machine, or process in which TI products or services are used. Information published by TI regarding third-party products or services does not constitute a license from TI to use such products or services or a warranty or endorsement thereof. Use of such information may require a license from a third party under the patents or other intellectual property of the third party, or a license from TI under the patents or other intellectual property of TI.

Reproduction of information in TI data books or data sheets is permissible only if reproduction is without alteration and is accompanied by all associated warranties, conditions, limitations, and notices. Reproduction of this information with alteration is an unfair and deceptive business practice. TI is not responsible or liable for such altered documentation.

Resale of TI products or services with statements different from or beyond the parameters stated by TI for that product or service voids all express and any implied warranties for the associated TI product or service and is an unfair and deceptive business practice. TI is not responsible or liable for any such statements.

Following are URLs where you can obtain information on other Texas Instruments products and application solutions:

Products		Applications	
Amplifiers	amplifier.ti.com	Audio	www.ti.com/audio
Data Converters	dataconverter.ti.com	Automotive	www.ti.com/automotive
DSP	dsp.ti.com	Broadband	www.ti.com/broadband
Interface	interface.ti.com	Digital Control	www.ti.com/digitalcontrol
Logic	logic.ti.com	Military	www.ti.com/military
Power Mgmt	power.ti.com	Optical Networking	www.ti.com/opticalnetwork
Microcontrollers	microcontroller.ti.com	Security	www.ti.com/security
		Telephony	www.ti.com/telephony
		Video & Imaging	www.ti.com/video
		Wireless	www.ti.com/wireless

Mailing Address: Texas Instruments
Post Office Box 655303 Dallas, Texas 75265