

**OPA241**  
**OPA2241**  
**OPA4241**  
**OPA251**  
**OPA2251**  
**OPA4251**

## Single-Supply, *MicroPOWER* OPERATIONAL AMPLIFIERS

**OPA241 Family** optimized for +5V supply.

**OPA251 Family** optimized for  $\pm 15V$  supply.

### FEATURES

- **MicroPOWER:**  $I_Q = 25\mu A$
- **SINGLE-SUPPLY OPERATION**
- **RAIL-TO-RAIL OUTPUT (within 50mV)**
- **WIDE SUPPLY RANGE**  
 Single Supply: +2.7V to +36V  
 Dual Supply:  $\pm 1.35V$  to  $\pm 18V$
- **LOW OFFSET VOLTAGE:**  $\pm 250\mu V$  max
- **HIGH COMMON-MODE REJECTION:** 124dB
- **HIGH OPEN-LOOP GAIN:** 128dB
- **SINGLE, DUAL, AND QUAD**

### APPLICATIONS

- **BATTERY OPERATED INSTRUMENTS**
- **PORTABLE DEVICES**
- **MEDICAL INSTRUMENTS**
- **TEST EQUIPMENT**

### DESCRIPTION

The OPA241 series and OPA251 series are specifically designed for battery powered, portable applications. In addition to very low power consumption ( $25\mu A$ ), these amplifiers feature low offset voltage, rail-to-rail output swing, high common-mode rejection, and high open-loop gain.

The OPA241 series is optimized for operation at low power supply voltage while the OPA251 series is optimized for high power supplies. Both can operate from either single (+2.7V to +36V) or dual supplies ( $\pm 1.35V$  to  $\pm 18V$ ). The input common-mode voltage range extends 200mV below the negative supply—ideal for single-supply applications.

They are unity-gain stable and can drive large capacitive loads. Special design considerations assure that these products are easy to use. High performance is maintained as the amplifiers swing to their specified limits. Because the initial offset voltage ( $\pm 250\mu V$  max) is so low, user adjustment is usually not required. However, external trim pins are provided for special applications (single versions only).

The OPA241 and OPA251 (single versions) are available in standard 8-pin DIP and SO-8 surface-mount packages. The OPA2241 and OPA2251 (dual versions) come in 8-pin DIP and SO-8 surface-mount packages. The OPA4241 and OPA4251 (quad versions) are available in 14-pin DIP and SO-14 surface-mount packages. All are fully specified from  $-40^\circ C$  to  $+85^\circ C$  and operate from  $-55^\circ C$  to  $+125^\circ C$ .

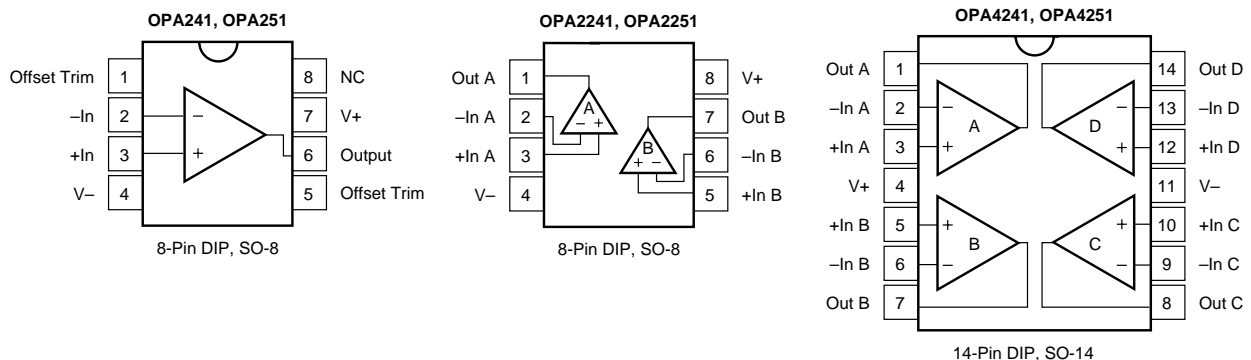

# SPECIFICATIONS: $V_S = 2.7V$ to $5V$

At  $T_A = +25^\circ C$ ,  $R_L = 100k\Omega$  connected to  $V_S/2$ , unless otherwise noted.

**Boldface** limits apply over the specified temperature range,  $T_A = -40^\circ C$  to  $+85^\circ C$ .

PARAMETER	CONDITION	OPA241UA, PA OPA2241UA, PA OPA4241UA, PA			OPA251UA, PA OPA2251UA, PA OPA4251UA, PA			UNITS
		MIN	TYP <sup>(1)</sup>	MAX	MIN	TYP <sup>(1)</sup>	MAX	
<b>OFFSET VOLTAGE</b> Input Offset Voltage $V_{OS}$ $T_A = -40^\circ C$ to $+85^\circ C$ vs Temperature $dV_{OS}/dT$ vs Power Supply PSRR $T_A = -40^\circ C$ to $+85^\circ C$ Channel Separation (dual, quad)	$T_A = -40^\circ C$ to $+85^\circ C$ $V_S = 2.7V$ to $36V$ $V_S = 2.7V$ to $36V$		$\pm 50$ <b><math>\pm 100</math></b> $\pm 0.4$ 3 0.3	$\pm 250$ <b><math>\pm 400</math></b> 30 <b>30</b>		$\pm 100$ <b><math>\pm 130</math></b> $\pm 0.6$ * *	* *	$\mu V$ $\mu V$ $\mu V/^\circ C$ $\mu V/V$ $\mu V/V$
<b>INPUT BIAS CURRENT</b> Input Bias Current <sup>(2)</sup> $I_B$ $T_A = -40^\circ C$ to $+85^\circ C$ Input Offset Current $I_{OS}$ $T_A = -40^\circ C$ to $+85^\circ C$			-4 $\pm 0.1$	-20 <b>-25</b> $\pm 2$ $\pm 2$		* *		nA nA nA nA
<b>NOISE</b> Input Voltage Noise, $f = 0.1Hz$ to $10Hz$ Input Voltage Noise Density, $f = 1kHz$ $e_n$ Current Noise Density, $f = 1kHz$ $i_n$			1 45 40			* * *		$\mu Vp-p$ $nV/\sqrt{Hz}$ $fA/\sqrt{Hz}$
<b>INPUT VOLTAGE RANGE</b> Common-Mode Voltage Range $V_{CM}$ Common-Mode Rejection Ratio CMRR $T_A = -40^\circ C$ to $+85^\circ C$	$V_{CM} = -0.2V$ to $(V+) - 0.8V$ $V_{CM} = 0V$ to $(V+) - 0.8V$	-0.2 80 <b>80</b>	106	$(V+) - 0.8$		*		V dB dB
<b>INPUT IMPEDANCE</b> Differential Common-Mode			$10^7 \parallel 2$ $10^9 \parallel 4$			* *		$\Omega \parallel pF$ $\Omega \parallel pF$
<b>OPEN-LOOP GAIN</b> Open-Loop Voltage Gain $A_{OL}$ $T_A = -40^\circ C$ to $+85^\circ C$	$R_L = 100k\Omega$ , $V_O = (V-)+100mV$ to $(V+)-100mV$ $R_L = 100k\Omega$ , $V_O = (V-)+100mV$ to $(V+)-100mV$ $R_L = 10k\Omega$ , $V_O = (V-)+200mV$ to $(V+)-200mV$ $R_L = 10k\Omega$ , $V_O = (V-)+200mV$ to $(V+)-200mV$	100 <b>100</b> 100 <b>100</b>	120 120			* *		dB dB dB dB
<b>FREQUENCY RESPONSE</b> Gain-Bandwidth Product GBW Slew Rate SR Overload Recovery Time	$V_S = 5V$ , $G = 1$ $V_{IN} \cdot G = V_S$		35 0.01 60			* * *		kHz V/ $\mu s$ $\mu s$
<b>OUTPUT</b> Voltage Output Swing from Rail <sup>(3)</sup> $V_O$ $T_A = -40^\circ C$ to $+85^\circ C$ $T_A = -40^\circ C$ to $+85^\circ C$ Short-Circuit Current $I_{SC}$ Single Versions Dual, Quad Versions Capacitive Load Drive $C_{LOAD}$	$R_L = 100k\Omega$ to $V_S/2$ , $A_{OL} \geq 70dB$ $R_L = 100k\Omega$ to $V_S/2$ , $A_{OL} \geq 100dB$ $R_L = 100k\Omega$ to $V_S/2$ , $A_{OL} \geq 100dB$ $R_L = 10k\Omega$ to $V_S/2$ , $A_{OL} \geq 100dB$ $R_L = 10k\Omega$ to $V_S/2$ , $A_{OL} \geq 100dB$		50 75 100	100 <b>100</b> 200 <b>200</b>		* * *		mV mV mV mV
<b>POWER SUPPLY</b> Specified Voltage Range $V_S$ Operating Voltage Range Quiescent Current (per amplifier) $I_Q$ $T_A = -40^\circ C$ to $+85^\circ C$	$T_A = -40^\circ C$ to $+85^\circ C$ $I_O = 0$ $I_O = 0$	<b>+2.7</b>	+2.7 to +5 $\pm 25$	<b>+36</b> $\pm 30$ <b><math>\pm 36</math></b>	*	* *	*	V V $\mu A$ $\mu A$
<b>TEMPERATURE RANGE</b> Specified Range Operating Range Storage Range Thermal Resistance $\theta_{JA}$ 8-Pin DIP SO-8 Surface Mount 14-Pin DIP SO-14 Surface Mount		-40 -55 -55		+85 +125 +125	* * *		* * *	$^\circ C$ $^\circ C$ $^\circ C$ $^\circ C/W$ $^\circ C/W$ $^\circ C/W$ $^\circ C/W$

\* Specifications the same as OPA241UA, PA.

NOTES: (1)  $V_S = +5V$ . (2) The negative sign indicates input bias current flows out of the input terminals. (3) Output voltage swings are measured between the output and power supply rails.

The information provided herein is believed to be reliable; however, BURR-BROWN assumes no responsibility for inaccuracies or omissions. BURR-BROWN assumes no responsibility for the use of this information, and all use of such information shall be entirely at the user's own risk. Prices and specifications are subject to change without notice. No patent rights or licenses to any of the circuits described herein are implied or granted to any third party. BURR-BROWN does not authorize or warrant any BURR-BROWN product for use in life support devices and/or systems.

# SPECIFICATIONS: $V_S = \pm 15V$

At  $T_A = +25^\circ C$ ,  $R_L = 100k\Omega$  connected to ground, unless otherwise noted.

**Boldface** limits apply over the specified temperature range,  $T_A = -40^\circ C$  to  $+85^\circ C$ .

PARAMETER	CONDITION	OPA241UA, PA OPA2241UA, PA OPA4241UA, PA			OPA251UA, PA OPA2251UA, PA OPA4251UA, PA			UNITS
		MIN	TYP	MAX	MIN	TYP	MAX	
<b>OFFSET VOLTAGE</b> Input Offset Voltage $V_{OS}$ $T_A = -40^\circ C$ to $+85^\circ C$ vs Temperature $dV_{OS}/dT$ vs Power Supply PSRR $T_A = -40^\circ C$ to $+85^\circ C$ Channel Separation (dual, quad)	$T_A = -40^\circ C$ to $+85^\circ C$ $V_S = \pm 1.35V$ to $\pm 18V$ $V_S = \pm 1.35V$ to $\pm 18V$		$\pm 100$ <b><math>\pm 150</math></b> $\pm 0.6$ * *			$\pm 50$ <b><math>\pm 100</math></b> $\pm 0.5$ 3 0.3	$\pm 250$ <b><math>\pm 300</math></b> 30 <b>30</b>	$\mu V$ $\mu V$ $\mu V/^\circ C$ $\mu V/V$ $\mu V/V$
<b>INPUT BIAS CURRENT</b> Input Bias Current <sup>(1)</sup> $I_B$ $T_A = -40^\circ C$ to $+85^\circ C$ Input Offset Current $I_{OS}$ $T_A = -40^\circ C$ to $+85^\circ C$			*			-4 $\pm 0.1$	-20 $\pm 2$	nA nA nA
<b>NOISE</b> Input Voltage Noise, $f = 0.1Hz$ to $10Hz$ Input Voltage Noise Density, $f = 1kHz$ $e_n$ Current Noise Density, $f = 1kHz$ $i_n$			*			1 45 40		$\mu V_{p-p}$ $nV/\sqrt{Hz}$ $fA/\sqrt{Hz}$
<b>INPUT VOLTAGE RANGE</b> Common-Mode Voltage Range $V_{CM}$ Common-Mode Rejection Ratio CMRR $T_A = -40^\circ C$ to $+85^\circ C$	$V_{CM} = -15.2V$ to $14.2V$ $V_{CM} = -15V$ to $14.2V$		*		(V-) -0.2 100 <b>100</b>	124	(V+) -0.8	V dB dB
<b>INPUT IMPEDANCE</b> Differential Common-Mode			*			$10^7 \parallel 2$ $10^9 \parallel 4$		$\Omega \parallel pF$ $\Omega \parallel pF$
<b>OPEN-LOOP GAIN</b> Open-Loop Voltage Gain $A_{OL}$ $T_A = -40^\circ C$ to $+85^\circ C$ $T_A = -40^\circ C$ to $+85^\circ C$	$R_L = 100k\Omega$ , $V_O = -14.75V$ to $+14.75V$ $R_L = 100k\Omega$ , $V_O = -14.75V$ to $+14.75V$ $R_L = 20k\Omega$ , $V_O = -14.7V$ to $+14.7V$ $R_L = 20k\Omega$ , $V_O = -14.7V$ to $+14.7V$		*		100 <b>100</b> 100 <b>100</b>	128 128		dB dB dB dB
<b>FREQUENCY RESPONSE</b> Gain-Bandwidth Product GBW Slew Rate SR Overload Recovery Time	$G = 1$ $V_{IN} \cdot G = V_S$		*			35 0.01 60		kHz V/ $\mu s$ $\mu s$
<b>OUTPUT</b> Voltage Output Swing from Rail <sup>(2)</sup> $V_O$ $T_A = -40^\circ C$ to $+85^\circ C$ $T_A = -40^\circ C$ to $+85^\circ C$ Short-Circuit Current $I_{SC}$ Single Versions Dual Versions Capacitive Load Drive $C_{LOAD}$	$R_L = 100k\Omega$ , $A_{OL} \geq 70dB$ $R_L = 100k\Omega$ , $A_{OL} \geq 100dB$ $R_L = 100k\Omega$ , $A_{OL} \geq 100dB$ $R_L = 20k\Omega$ , $A_{OL} \geq 100dB$ $R_L = 20k\Omega$ , $A_{OL} \geq 100dB$		*			50 75 100	250 <b>250</b> 300 <b>300</b>	mV mV mV mV mA mA
<b>POWER SUPPLY</b> Specified Voltage Range $V_S$ Operating Voltage Range Quiescent Current (per amplifier) $I_Q$ $T_A = -40^\circ C$ to $+85^\circ C$	$T_A = -40^\circ C$ to $+85^\circ C$ $I_Q = 0$ $I_Q = 0$		*	*	$\pm 1.35$	$\pm 15$ $\pm 27$	$\pm 18$ $\pm 38$ <b><math>\pm 45</math></b>	V V $\mu A$ $\mu A$
<b>TEMPERATURE RANGE</b> Specified Range Operating Range Storage Range Thermal Resistance $\theta_{JA}$ 8-Pin DIP SO-8 Surface Mount 14-Pin DIP SO-14 Surface Mount			*	*	-40 -55 -55		+85 +125 +125	$^\circ C$ $^\circ C$ $^\circ C$ $^\circ C/W$ $^\circ C/W$ $^\circ C/W$ $^\circ C/W$

\* Specifications the same as OPA251UA, PA.

NOTES: (1) The negative sign indicates input bias current flows out of the input terminals. (2) Output voltage swings are measured between the output and power supply rails.

## ABSOLUTE MAXIMUM RATINGS<sup>(1)</sup>

Supply Voltage, V+ to V- .....	36V
Input Voltage <sup>(2)</sup> .....	(V-) -0.5V to (V+) +0.5V
Output Short Circuit to Ground <sup>(3)</sup> .....	Continuous
Operating Temperature .....	-55°C to +125°C
Storage Temperature .....	-55°C to +125°C
Junction Temperature .....	150°C
Lead Temperature (soldering, 10s) .....	300°C

NOTES: (1) Stresses above these ratings may cause permanent damage.  
 (2) Input terminals are diode-clamped to the power supply rails. Input signals that can swing more than 0.5V beyond the supply rails should be current-limited to 5mA or less. (3) One amplifier per package.



## ELECTROSTATIC DISCHARGE SENSITIVITY

This integrated circuit can be damaged by ESD. Burr-Brown recommends that all integrated circuits be handled with appropriate precautions. Failure to observe proper handling and installation procedures can cause damage.

ESD damage can range from subtle performance degradation to complete device failure. Precision integrated circuits may be more susceptible to damage because very small parametric changes could cause the device not to meet its published specifications.

## PACKAGE/ORDERING INFORMATION

PRODUCT	SPECIFIED VOLTAGE	OPERATING VOLTAGE RANGE	PACKAGE	PACKAGE DRAWING NUMBER <sup>(1)</sup>	SPECIFICATION TEMPERATURE RANGE
<b>OPA241 SERIES</b>					
<b>Single</b>					
OPA241PA	2.7V to 5V	2.7V to 36V	8-Pin DIP	006	-40°C to +85°C
OPA241UA	2.7V to 5V	2.7V to 36V	SO-8 Surface Mount	182	-40°C to +85°C
<b>Dual</b>					
OPA2241PA	2.7V to 5V	2.7V to 36V	8-Pin DIP	006	-40°C to +85°C
OPA2241UA	2.7V to 5V	2.7V to 36V	SO-8 Surface Mount	182	-40°C to +85°C
<b>Quad</b>					
OPA4241PA	2.7V to 5V	2.7V to 36V	14-Pin DIP	010	-40°C to +85°C
OPA4241UA	2.7V to 5V	2.7V to 36V	SO-14 Surface Mount	235	-40°C to +85°C
<b>OPA251 SERIES</b>					
<b>Single</b>					
OPA251PA	±15V	2.7V to 36V	8-Pin DIP	006	-40°C to +85°C
OPA251UA	±15V	2.7V to 36V	SO-8 Surface Mount	182	-40°C to +85°C
<b>Dual</b>					
OPA2251PA	±15V	2.7V to 36V	8-Pin DIP	006	-40°C to +85°C
OPA2251UA	±15V	2.7V to 36V	SO-8 Surface Mount	182	-40°C to +85°C
<b>Quad</b>					
OPA4251PA	±15V	2.7V to 36V	14-Pin DIP	010	-40°C to +85°C
OPA4251UA	±15V	2.7V to 36V	SO-14 Surface Mount	235	-40°C to +85°C

NOTE: (1) For detailed drawing and dimension table, please see end of data sheet, or Appendix C of Burr-Brown IC Data Book.

# TYPICAL PERFORMANCE CURVES

At  $T_A = +25^\circ\text{C}$ , and  $R_L = 100\text{k}\Omega$  connected to  $V_S/2$  (ground for  $V_S = \pm 15\text{V}$ ), unless otherwise noted.

Curves apply to OPA241 and OPA251 unless specified.

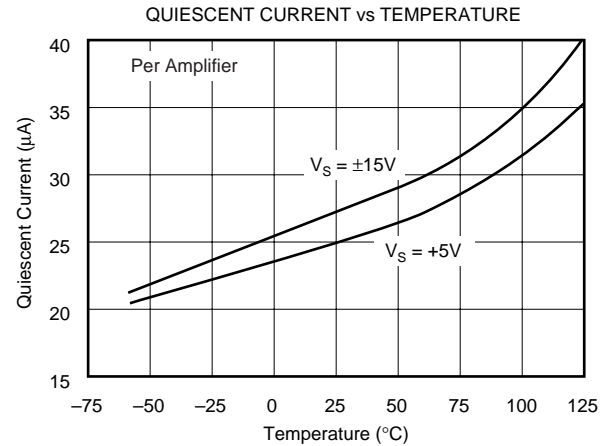
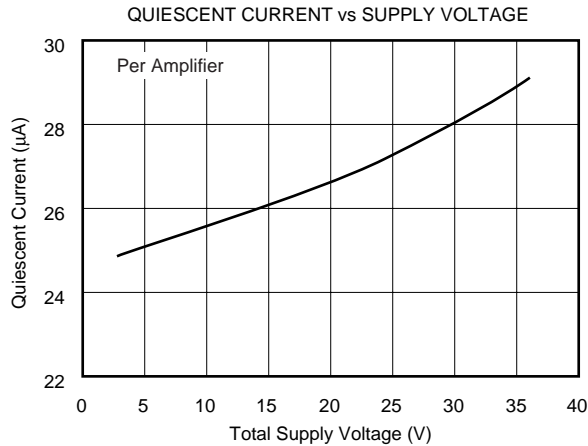
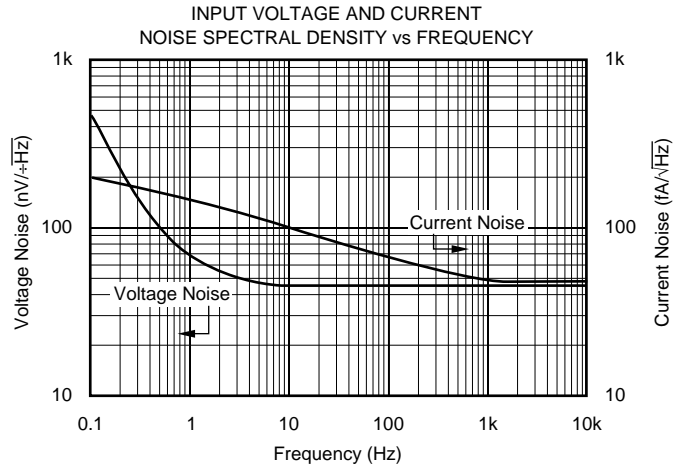
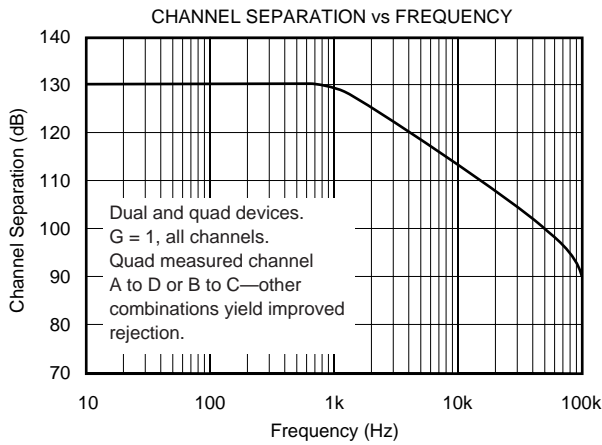
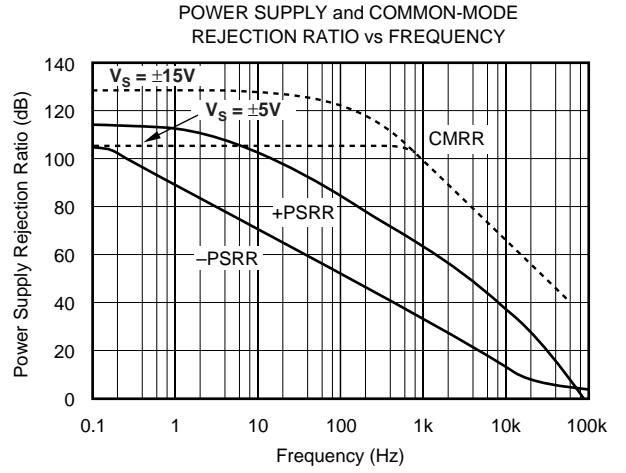
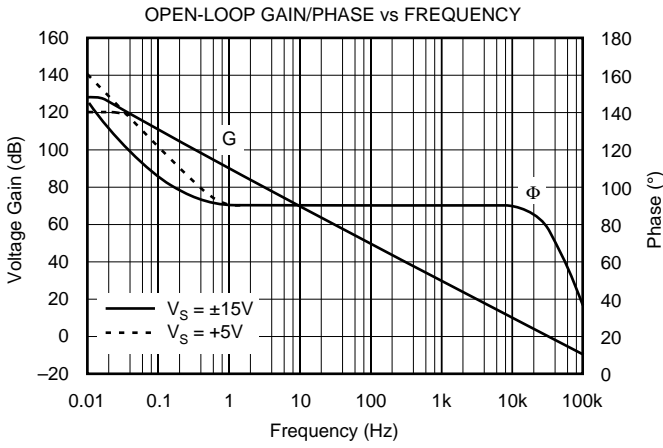

# TYPICAL PERFORMANCE CURVES (CONT)

At  $T_A = +25^\circ\text{C}$ , and  $R_L = 100\text{k}\Omega$  connected to  $V_S/2$  (ground for  $V_S = \pm 15\text{V}$ ), unless otherwise noted.

Curves apply to OPA241 and OPA251 unless specified.

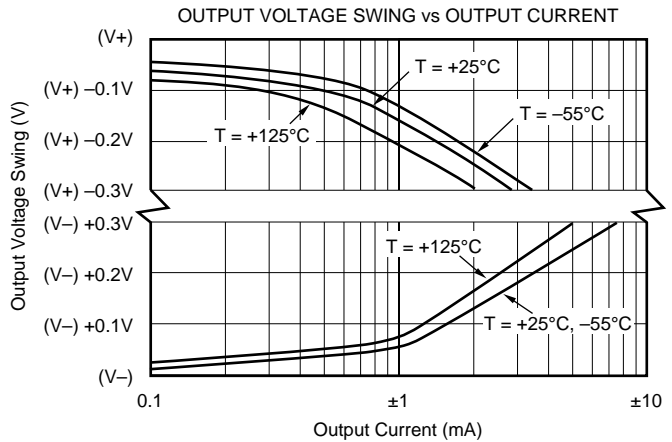
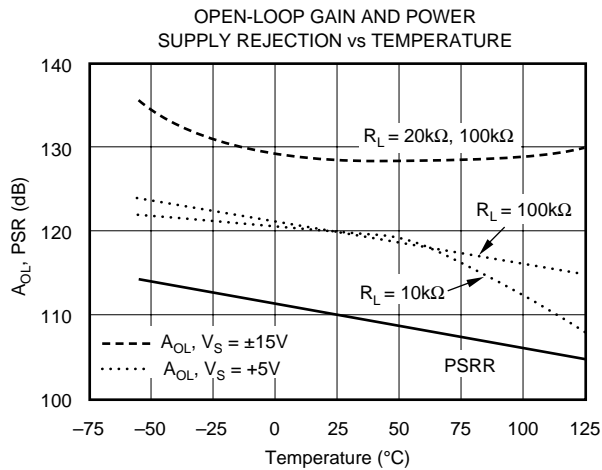
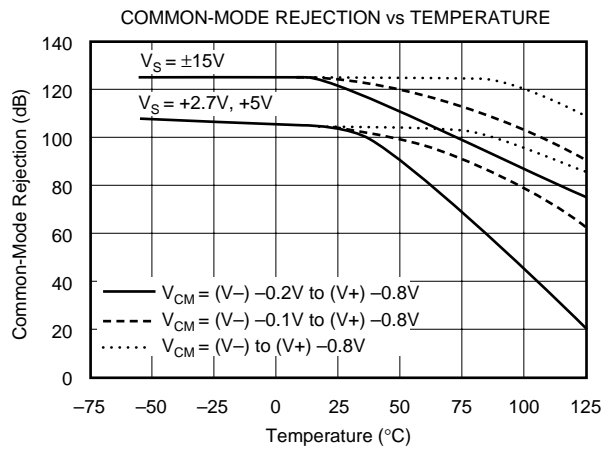
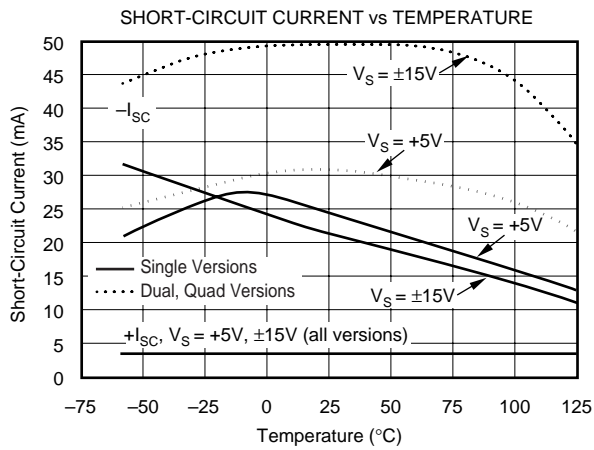
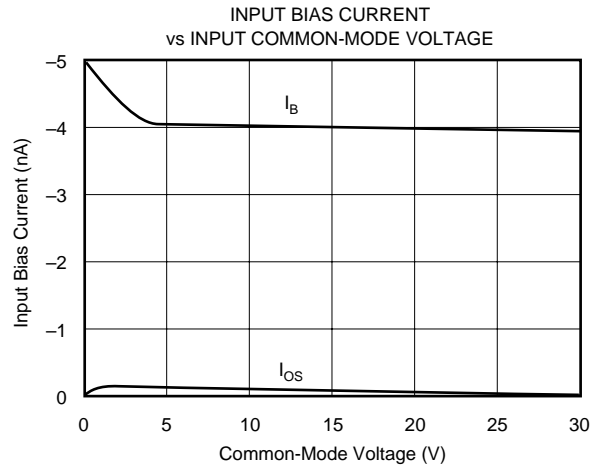
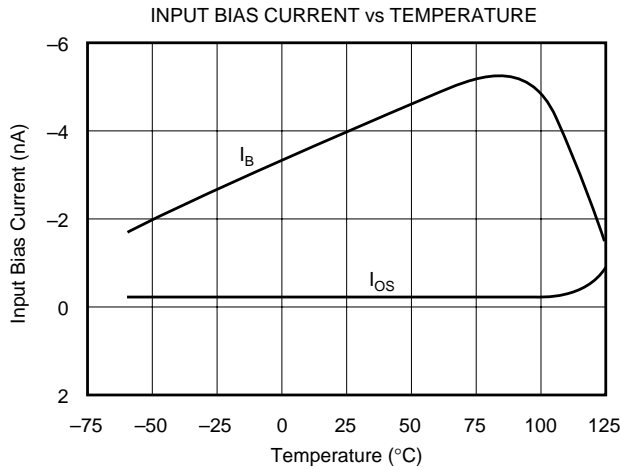

# TYPICAL PERFORMANCE CURVES (CONT)

At  $T_A = +25^\circ\text{C}$ , and  $R_L = 100\text{k}\Omega$  connected to  $V_S/2$  (ground for  $V_S = \pm 15\text{V}$ ), unless otherwise noted.

Curves apply to OPA241 and OPA251 unless specified.

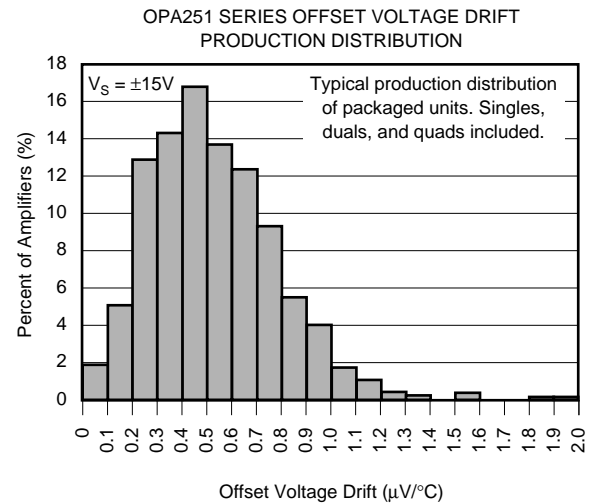
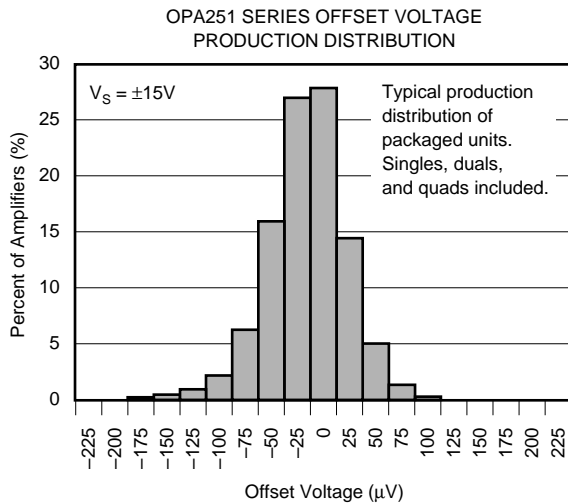
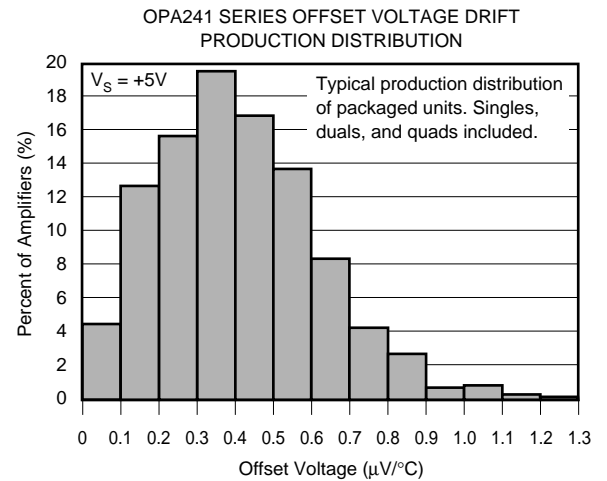
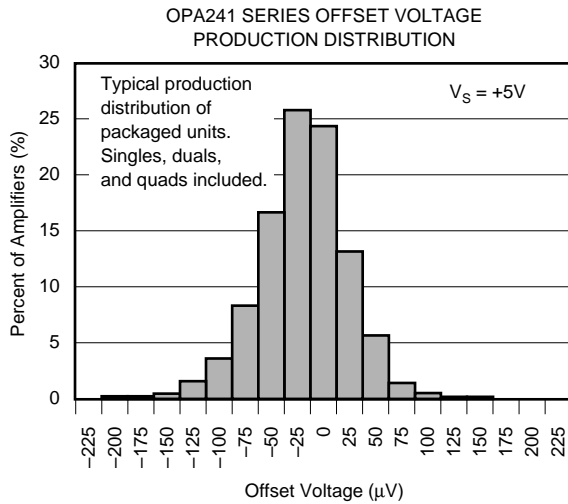
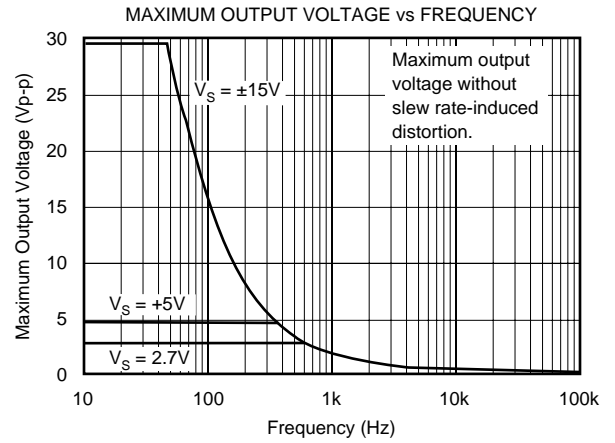
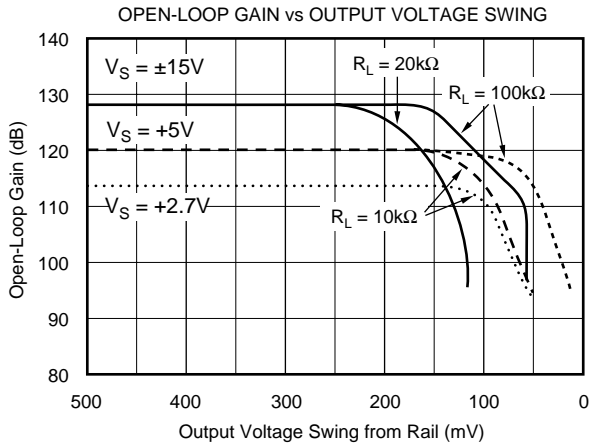

# TYPICAL PERFORMANCE CURVES (CONT)

At  $T_A = +25^\circ\text{C}$ , and  $R_L = 100\text{k}\Omega$  connected to  $V_S/2$  (ground for  $V_S \pm 15\text{V}$ ), unless otherwise noted.

Curves apply to OPA241 and OPA251 unless specified.

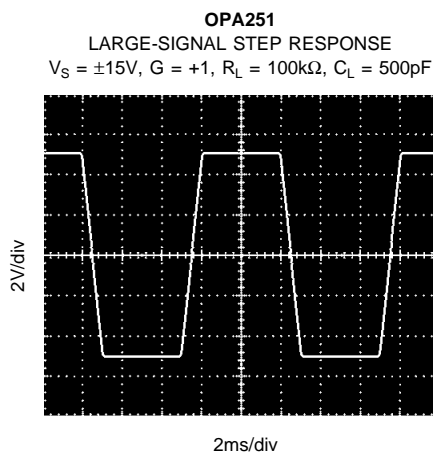
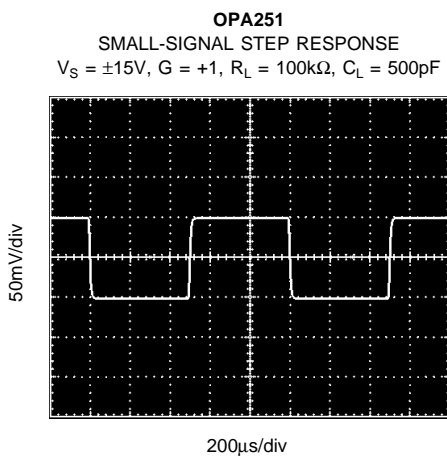
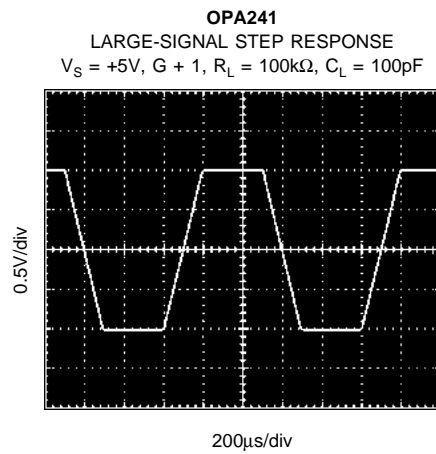
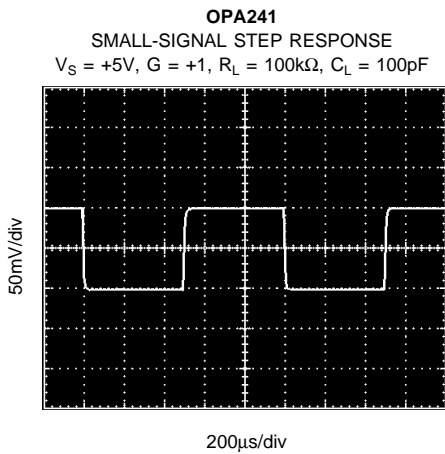
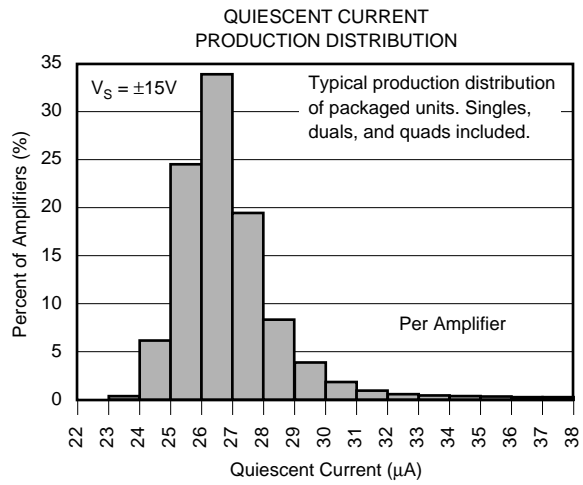
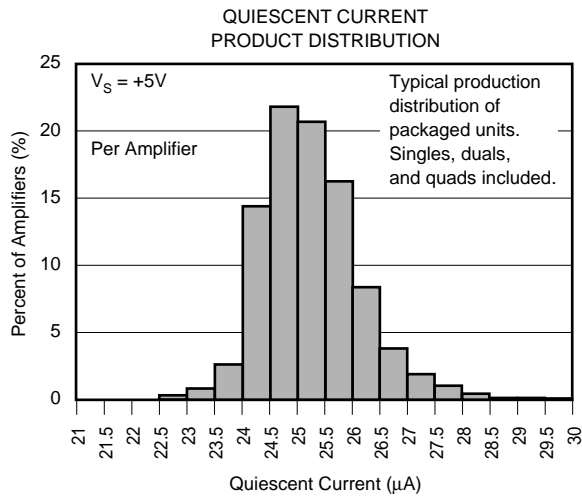



# APPLICATIONS INFORMATION

The OPA241 and OPA251 series are unity-gain stable and suitable for a wide range of general purpose applications. Power supply pins should be bypassed with 0.01μF ceramic capacitors.

## OPERATING VOLTAGE

The OPA241 series is laser-trimmed for low offset voltage and drift at low supply voltage ( $V_S = +5V$ ). The OPA251 series is trimmed for  $\pm 15V$  operation. Both products operate over the full voltage range (+2.7V to +36V or  $\pm 1.35V$  to  $\pm 18V$ ) with some compromises in offset voltage and drift performance. However, all other parameters have similar performance. Key parameters are guaranteed over the specified temperature range,  $-40^\circ C$  to  $+85^\circ C$ . Most behavior remains unchanged throughout the full operating voltage range. Parameters which vary significantly with operating voltage or temperature are shown in typical performance curves.

## OFFSET VOLTAGE TRIM

As mentioned previously, offset voltage of the OPA241 series is laser-trimmed at +5V. The OPA251 series is trimmed at  $\pm 15V$ . Because the initial offset is so low, user adjustment is usually not required. However, the OPA241 and OPA251 (single op amp versions) provide offset voltage trim connections on pins 1 and 5. Offset voltage can be adjusted by connecting a potentiometer as shown in Figure 1. This adjustment should be used only to null the offset of the op amp, not to adjust system offset or offset produced by the signal source. Nulling offset could degrade the offset drift behavior of the op amp. While it is not possible to predict the exact change in drift, the effect is usually small.

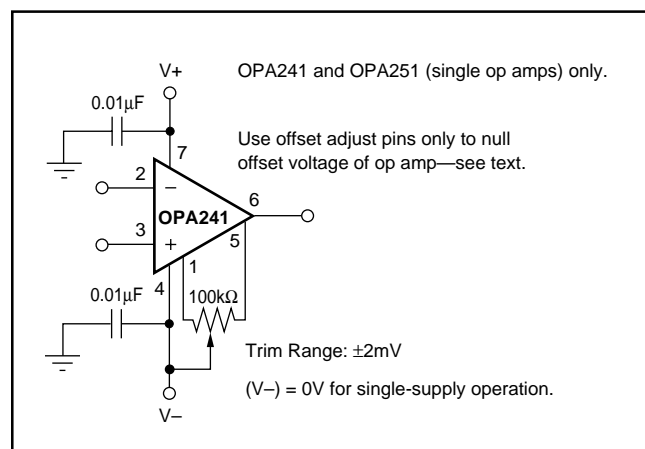

FIGURE 1. OPA241 and OPA251 Offset Voltage Trim Circuit.

## CAPACITIVE LOAD AND STABILITY

The OPA241 series and OPA251 series can drive a wide range of capacitive loads. However, all op amps under certain conditions may be unstable. Op amp configuration, gain, and load value are just a few of the factors to consider when determining stability.

Figures 2 and 3 show the regions where the OPA241 series and OPA251 series have the potential for instability. As shown, the unity gain configuration with low supplies is the most susceptible to the effects of capacitive load. With  $V_S = +5V$ ,  $G = +1$ , and  $I_{OUT} = 0$ , operation remains stable with load capacitance up to approximately 200pF. Increasing supply voltage, output current, and/or gain significantly improves capacitive load drive. For example, increasing the supplies to  $\pm 15V$  and gain to 10 allows approximately 2700pF to be driven.

One method of improving capacitive load drive in the unity gain configuration is to insert a resistor inside the feedback loop as shown in Figure 4. This reduces ringing with large capacitive loads while maintaining dc accuracy. For example, with  $V_S = \pm 1.35V$  and  $R_S = 5k\Omega$ , the OPA241 series and OPA251 series perform well with capacitive loads in excess of 1000pF. Without the series resistor, capacitive load drive is typically 200pF for these conditions. However, this method will result in a slight reduction of output voltage swing.

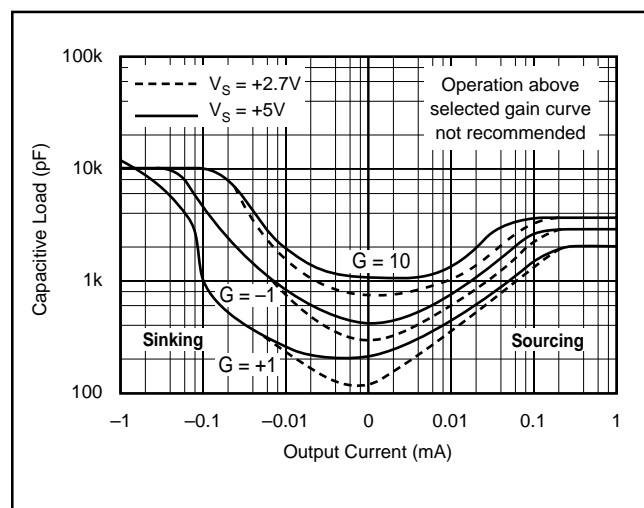

FIGURE 2. Stability—Capacitive Load versus Output Current for Low Supply Voltage.

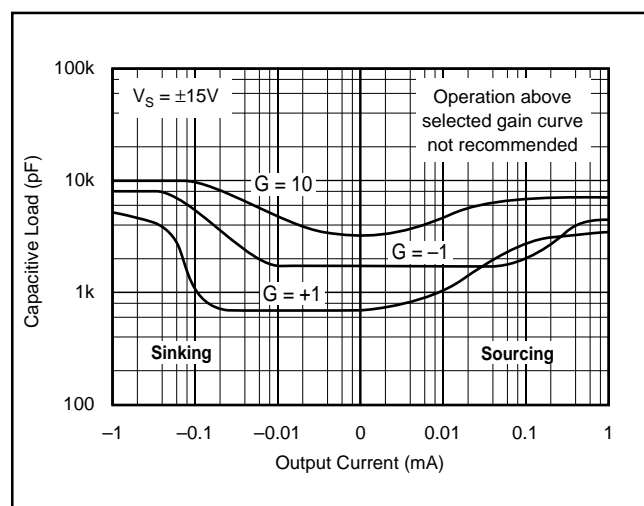

FIGURE 3. Stability—Capacitive Load versus Output Current for  $\pm 15V$  Supplies.

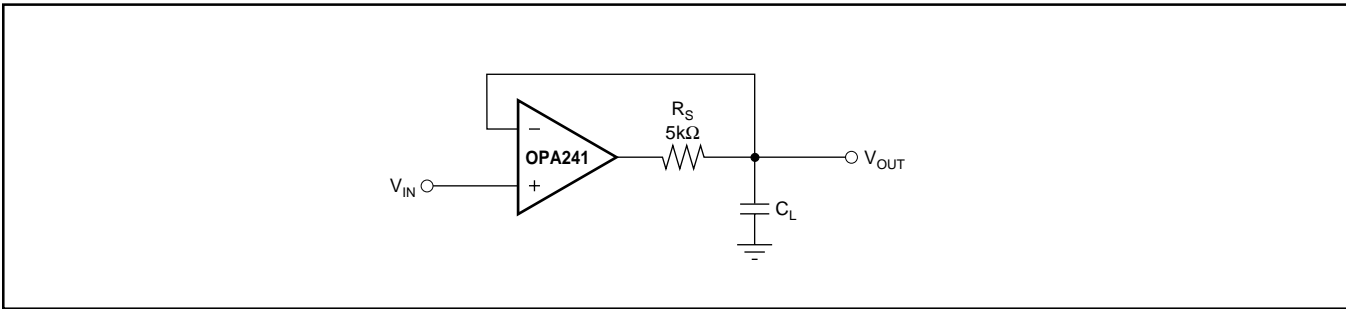

FIGURE 4. Series Resistor in Unity Gain Configuration Improves Capacitive Load Drive.

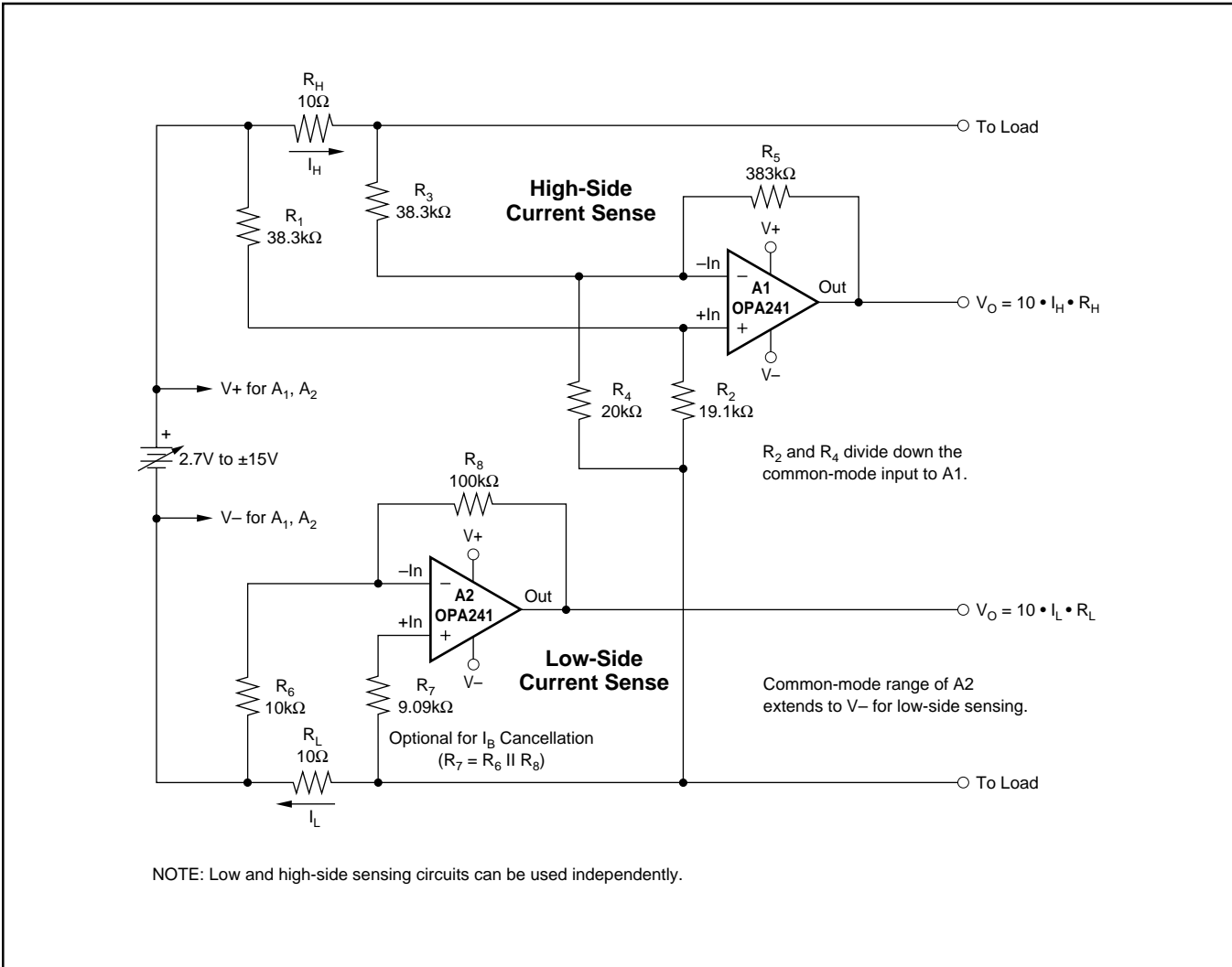

FIGURE 5. Low and High-Side Battery Current Sensing.

## **IMPORTANT NOTICE**

Texas Instruments and its subsidiaries (TI) reserve the right to make changes to their products or to discontinue any product or service without notice, and advise customers to obtain the latest version of relevant information to verify, before placing orders, that information being relied on is current and complete. All products are sold subject to the terms and conditions of sale supplied at the time of order acknowledgment, including those pertaining to warranty, patent infringement, and limitation of liability.

TI warrants performance of its semiconductor products to the specifications applicable at the time of sale in accordance with TI's standard warranty. Testing and other quality control techniques are utilized to the extent TI deems necessary to support this warranty. Specific testing of all parameters of each device is not necessarily performed, except those mandated by government requirements.

Customers are responsible for their applications using TI components.

In order to minimize risks associated with the customer's applications, adequate design and operating safeguards must be provided by the customer to minimize inherent or procedural hazards.

TI assumes no liability for applications assistance or customer product design. TI does not warrant or represent that any license, either express or implied, is granted under any patent right, copyright, mask work right, or other intellectual property right of TI covering or relating to any combination, machine, or process in which such semiconductor products or services might be or are used. TI's publication of information regarding any third party's products or services does not constitute TI's approval, warranty or endorsement thereof.