

# 1-MHz 45- $\mu$ A CMOS RAIL-TO-RAIL OPERATIONAL AMPLIFIER

 Check for Samples: [OPA2348-Q1](#), [OPA4348-Q1](#)

## FEATURES

- Qualified for Automotive Applications
- Low Quiescent Current ( $I_Q$ ): 45  $\mu$ A (Typ)
- Low Cost
- Rail-to-Rail Input and Output
- Single Supply: 2.1 V to 5.5 V
- Input Bias Current: 0.5 pA (Typ)
- High Speed: Power With Bandwidth: 1 MHz

## APPLICATIONS

- Portable Equipment
- Battery-Powered Equipment
- Smoke Alarms
- CO Detectors
- Medical Instrumentation

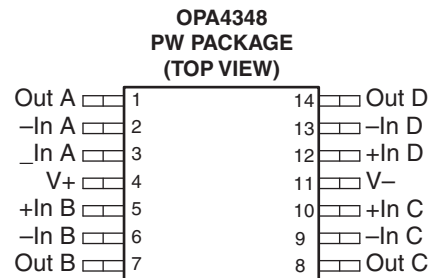
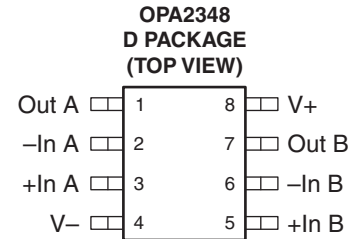

## DESCRIPTION

The OPAx348 series amplifiers are single-supply low-power CMOS operational amplifiers. Featuring an extended bandwidth of 1 MHz and a supply current of 45  $\mu$ A, the OPAx348 is useful for low-power applications on single supplies of 2.1 V to 5.5 V.

Low supply current of 45  $\mu$ A and an input bias current of 0.5 pA make the OPAx348 an optimal candidate for low-power high-impedance applications such as smoke detectors and other sensors.

The OPA2348 is available in the SOIC-8 (D) package, and the OPA4348 is available in the TSSOP-14 (PW) package. The automotive temperature range of  $-40^{\circ}\text{C}$  to  $125^{\circ}\text{C}$  over all supply voltages offers additional design flexibility.

## ORDERING INFORMATION<sup>(1)</sup>

$T_A$	PACKAGE <sup>(2)</sup>		ORDERABLE PART NUMBER	TOP-SIDE MARKING
$-40^{\circ}\text{C}$ to $125^{\circ}\text{C}$	SOIC – D	Reel of 2500	OPA2348AQDRQ1	2348Q
	TSSOP – PW	Reel of 2000	OPA4348AQPWRQ1	OP4348Q

(1) For the most current package and ordering information, see the Package Option Addendum at the end of this document, or see the TI web site at [www.ti.com](http://www.ti.com).

(2) Package drawings, thermal data, and symbolization are available at [www.ti.com/packaging](http://www.ti.com/packaging).



Please be aware that an important notice concerning availability, standard warranty, and use in critical applications of Texas Instruments semiconductor products and disclaimers thereto appears at the end of this data sheet.



This integrated circuit can be damaged by ESD. Texas Instruments recommends that all integrated circuits be handled with appropriate precautions. Failure to observe proper handling and installation procedures can cause damage.

ESD damage can range from subtle performance degradation to complete device failure. Precision integrated circuits may be more susceptible to damage because very small parametric changes could cause the device not to meet its published specifications.

## ABSOLUTE MAXIMUM RATINGS<sup>(1)</sup>

over operating free-air temperature range (unless otherwise noted)

$V_S$	Supply voltage, V– to V+		7.5 V
$V_{IN}$	Input voltage, signal input terminals <sup>(2)</sup>		(V– – 0.5 V) to (V+ + 0.5 V)
$I_{IN}$	Input current, signal input terminals <sup>(2)</sup>		10 mA
	Output short-circuit duration <sup>(3)</sup>		Continuous
$\theta_{JA}$	Thermal impedance, junction to free air <sup>(4)</sup>	D package	97.1°C/W
		PW package	100°C/W
$T_A$	Operating free-air temperature		–40°C to +150°C
$T_{STG}$	Storage temperature		–65°C to +150°C
$T_J$	Operating virtual-junction temperature		150°C

- (1) Stresses beyond those listed under *absolute maximum ratings* may cause permanent damage to the device. These are stress ratings only, and functional operation of the device at these or any other conditions beyond those indicated under *recommended operating conditions* is not implied. Exposure to absolute-maximum-rated conditions for extended periods may affect device reliability.
- (2) Input terminals are diode-clamped to the power-supply rails. Input signals that can swing more than 0.5 V beyond the supply rails should be current-limited to 10 mA or less.
- (3) Short-circuit to ground, one amplifier per package.
- (4) The package thermal impedance is calculated in accordance with JESD 51-5.

## RECOMMENDED OPERATING CONDITIONS

		MIN	MAX	UNIT
$V_S$	Supply voltage, V– to V+	2.1	5.5	V
$T_A$	Operating free-air temperature	–40	125	°C

## ELECTRICAL CHARACTERISTICS

 $V_S = 2.5\text{ V to }5.5\text{ V}$ ,  $R_L = 100\text{ k}\Omega$  connected to  $V_S/2$ ,  $V_{OUT} = V_S/2$  (unless otherwise noted)

PARAMETER		TEST CONDITIONS	$T_A$ <sup>(1)</sup>	MIN	TYP	MAX	UNIT
$V_{OS}$	Input offset voltage	$V_S = 5\text{ V}$ , $V_{CM} = (V-) + 0.8\text{ V}$	25°C		1	5	mV
			Full range			6	
$\Delta V_{OS}/\Delta T$	Offset voltage drift over temperature		Full range		4		$\mu\text{V}/^\circ\text{C}$
PSRR	Offset voltage drift vs power supply	$V_S = 2.5\text{ V to }5.5\text{ V}$ , $V_{CM} < (V+) - 1.7\text{ V}$	25°C		60	175	$\mu\text{V}/\text{V}$
			Full range			300	
	Offset voltage channel separation	dc	25°C		0.2		$\mu\text{V}/\text{V}$
			25°C		134		dB
$V_{CM}$	Input common-mode voltage range		25°C	$(V-) - 0.2$		$(V+) + 0.2$	V
CMRR	Input common-mode rejection ratio	$(V-) - 0.2\text{ V} < V_{CM} < (V+) - 1.7\text{ V}$	25°C	70	82		dB
			Full range	66			
			25°C	60	71		
			Full range	56			
$I_B$	Input bias current		25°C		$\pm 0.5$	$\pm 10$	pA
$I_{OS}$	Input offset current		25°C		$\pm 0.5$	$\pm 10$	pA
$Z_i$	Input impedance	Differential	25°C	$10^{13}  3$			$\Omega  \text{pF}$
		Common-mode		$10^{13}  3$			
	Input voltage noise	$V_{CM} < (V+) - 1.7\text{ V}$ , $f = 0.1\text{ Hz to }10\text{ Hz}$	25°C		10		$\mu\text{V}_{PP}$
$V_n$	Input voltage noise density	$V_{CM} < (V+) - 1.7\text{ V}$ , $f = 1\text{ kHz}$	25°C		35		$\text{nV}/\sqrt{\text{Hz}}$
$I_n$	Input current noise density	$V_{CM} < (V+) - 1.7\text{ V}$ , $f = 1\text{ kHz}$	25°C		4		$\text{fA}/\sqrt{\text{Hz}}$
$A_{OL}$	Open-loop voltage gain	$V_S = 5\text{ V}$ , $R_L = 100\text{ k}\Omega$ , $0.025\text{ V} < V_O < 4.975\text{ V}$	25°C	94	108		dB
			Full range	90			
			25°C	90	98		
			Full range	88			
	Voltage output swing from rail	$R_L = 100\text{ k}\Omega$ , $A_{OL} > 94\text{ dB}$	25°C		18	25	mV
			Full range			25	
			25°C		100	125	
			Full range			125	
$I_{SC}$	Output short-circuit current		25°C		$\pm 10$		mA
$C_{LOAD}$	Capacitive load drive	See <i>Typical Characteristics</i>	25°C				
GBW	Gain-bandwidth product	$C_L = 100\text{ pF}$	25°C		1		MHz
SR	Slew rate	$C_L = 100\text{ pF}$ , $G = +1$	25°C		0.5		V/ $\mu\text{s}$
$t_s$	Settling time	$C_L = 100\text{ pF}$ , $V_S = 5.5\text{ V}$ , 2V- step, $G = +1$	25°C	0.1%		5	$\mu\text{s}$
				0.01%		7	
	Overload recovery time	$V_{IN} \times \text{Gain} > V_S$	25°C		1.6		$\mu\text{s}$
THD+N	Total harmonic distortion plus noise	$C_L = 100\text{ pF}$ , $V_S = 5.5\text{ V}$ , $V_O = 3\text{ V}_{PP}$ , $G = +1$ , $f = 1\text{ kHz}$	25°C		0.0023		%
$I_Q$	Quiescent current	Per amplifier	25°C		45	65	$\mu\text{A}$
			Full range			75	

 (1) Full range  $T_A = -40^\circ\text{C to }125^\circ\text{C}$

**TYPICAL CHARACTERISTICS**

$T_A = 25^\circ\text{C}$ ,  $R_L = 100\text{ k}\Omega$  connected to  $V_S/2$ ,  $V_{OUT} = V_S/2$  (unless otherwise noted)

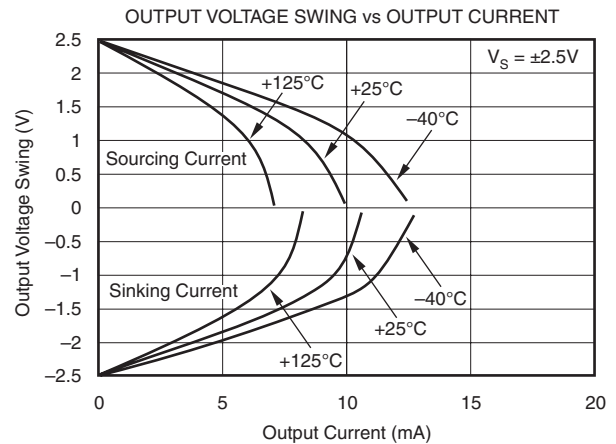
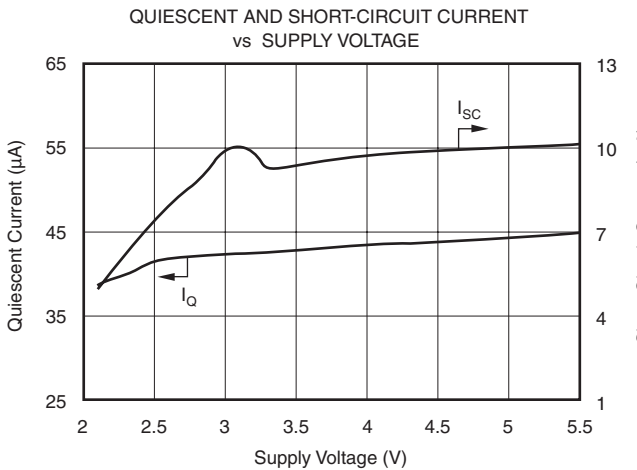
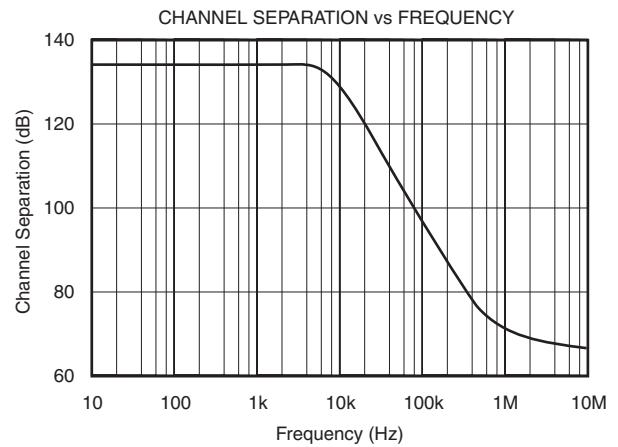
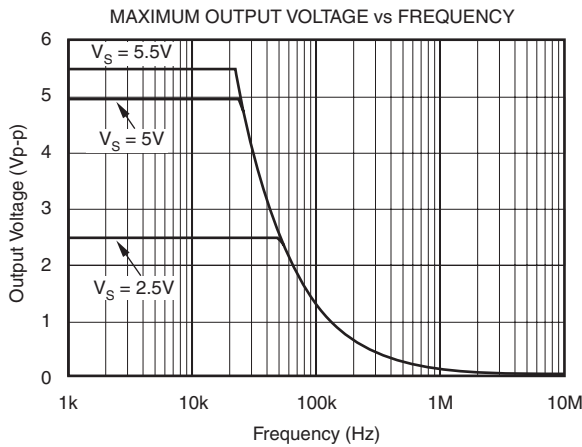
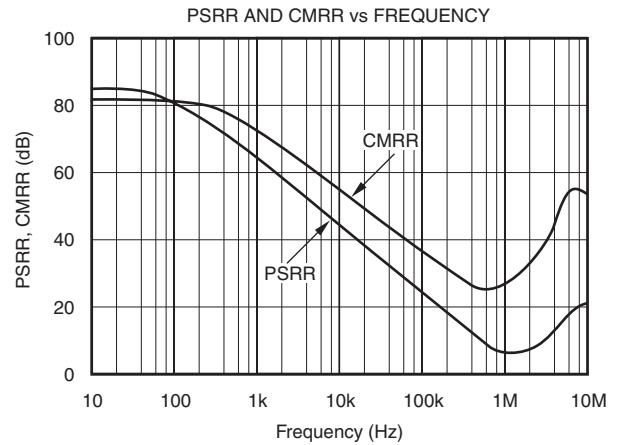
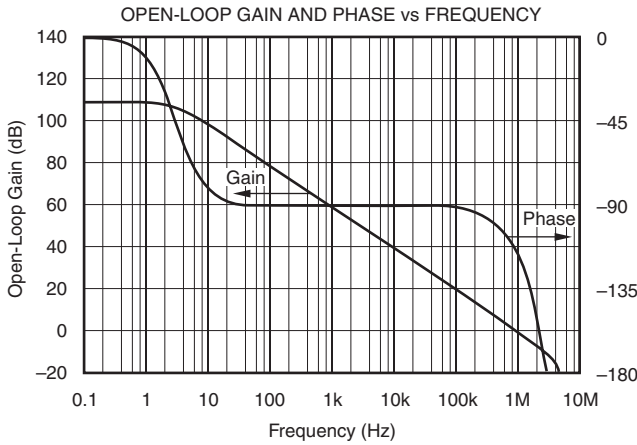

TYPICAL CHARACTERISTICS (continued)

$T_A = 25^\circ\text{C}$ ,  $R_L = 100\text{ k}\Omega$  connected to  $V_S/2$ ,  $V_{OUT} = V_S/2$  (unless otherwise noted)

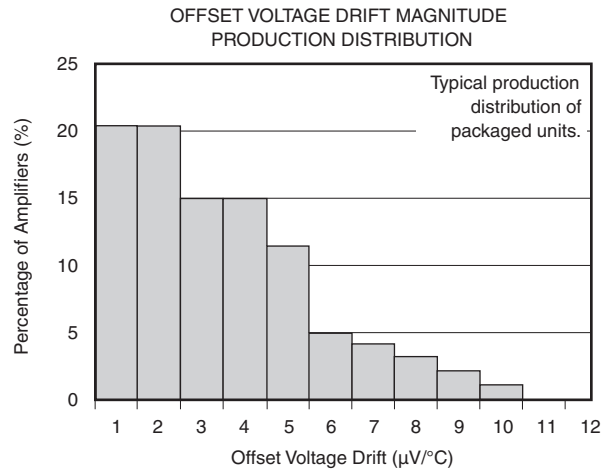
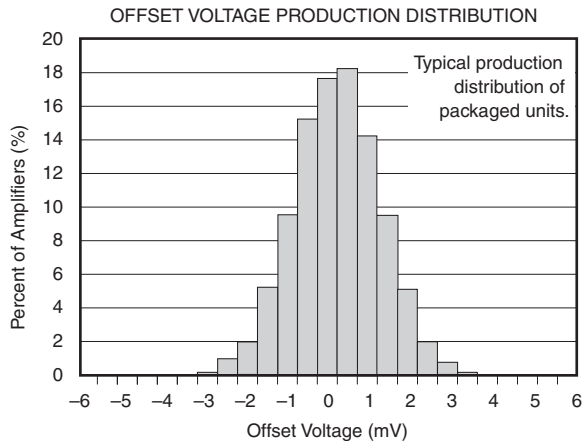
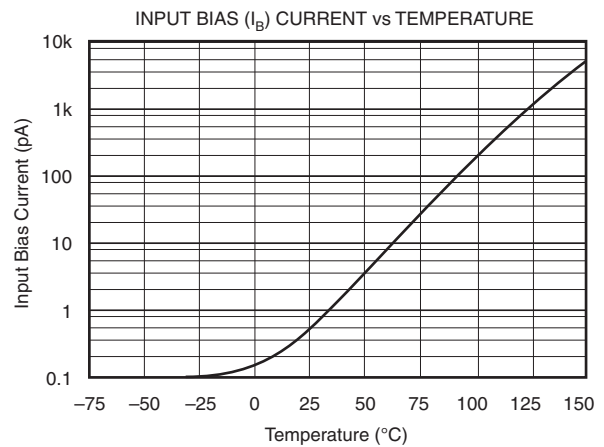
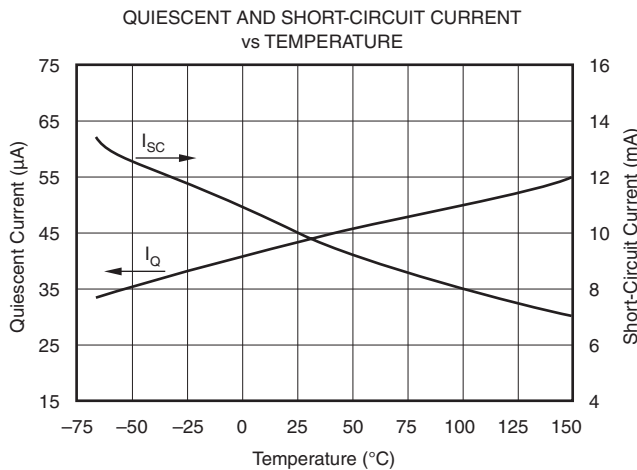
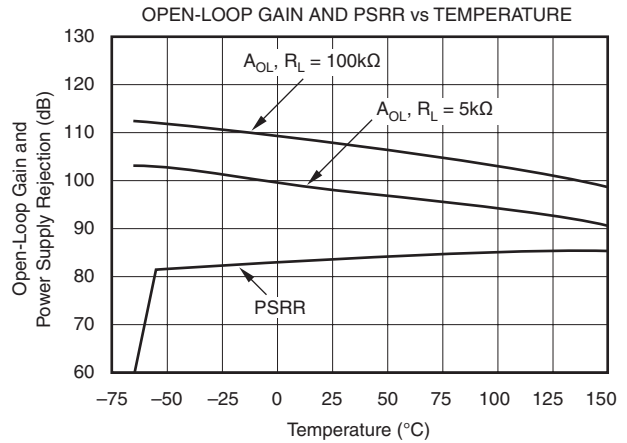
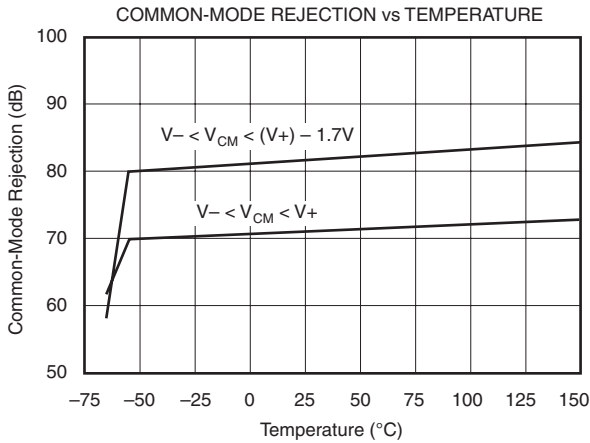

**TYPICAL CHARACTERISTICS (continued)**

$T_A = 25^\circ\text{C}$ ,  $R_L = 100\text{ k}\Omega$  connected to  $V_S/2$ ,  $V_{OUT} = V_S/2$  (unless otherwise noted)

SMALL-SIGNAL OVERSHOOT  
vs LOAD CAPACITANCE

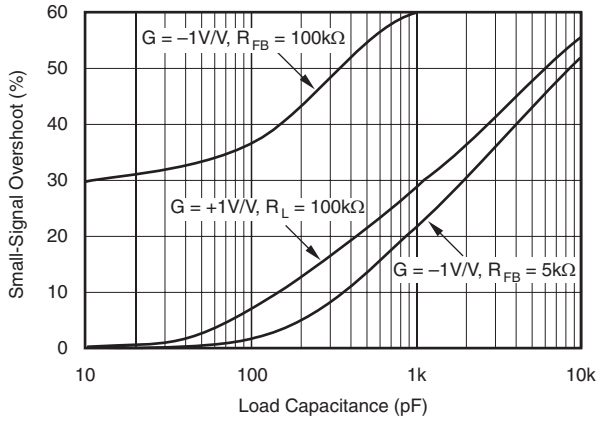

PERCENT OVERSHOOT vs LOAD CAPACITANCE

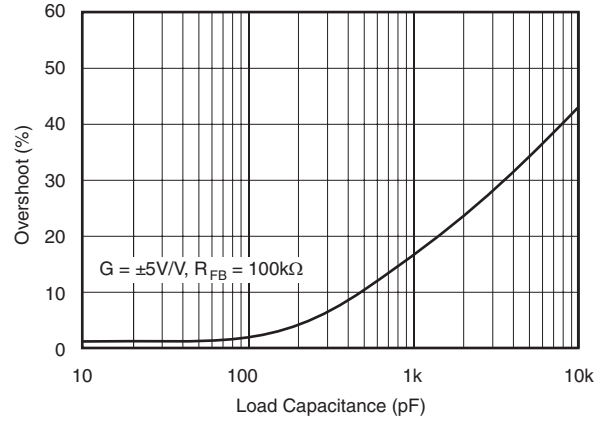

SMALL-SIGNAL STEP RESPONSE  
 $G = +1\text{V/V}$ ,  $R_L = 100\text{ k}\Omega$ ,  $C_L = 100\text{ pF}$

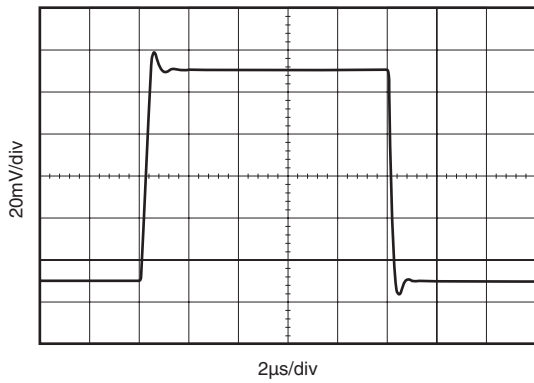

LARGE-SIGNAL STEP RESPONSE  
 $G = +1\text{V/V}$ ,  $R_L = 100\text{ k}\Omega$ ,  $C_L = 100\text{ pF}$

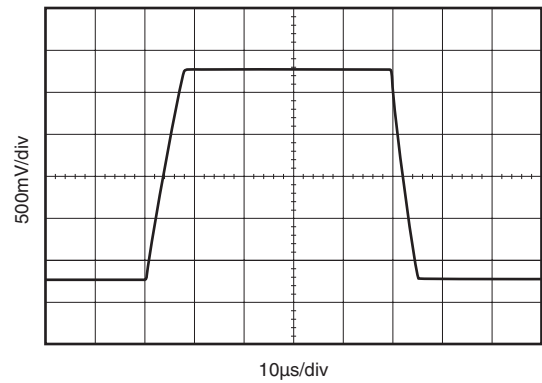

INPUT CURRENT AND VOLTAGE NOISE  
SPECTRAL DENSITY vs FREQUENCY

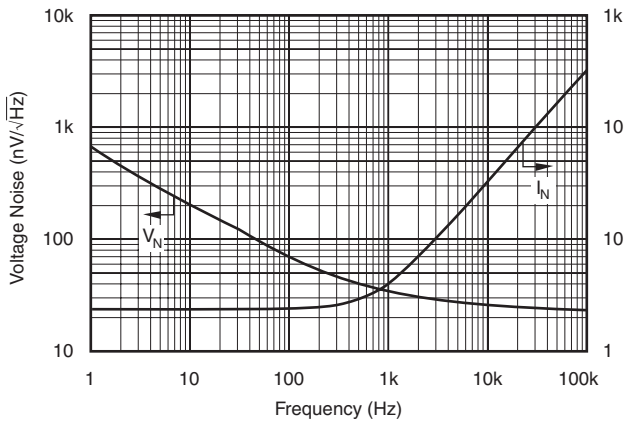

TOTAL HARMONIC DISTORTION + NOISE  
vs FREQUENCY

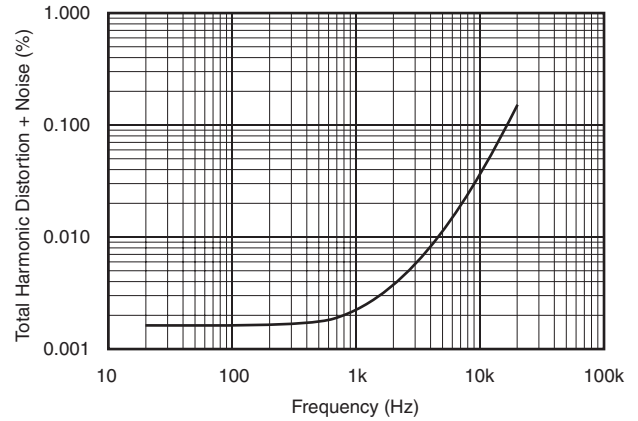

## APPLICATION INFORMATION

OPA2348 op amps are unity-gain stable and suitable for a wide range of general-purpose applications.

The OPA2348 features wide bandwidth and unity-gain stability with rail-to-rail input and output for increased dynamic range. Figure 1 shows the input and output waveforms for the OPA2348 in unity-gain configuration. Operation is from a single 5-V supply with a 100-k $\Omega$  load connected to  $V_S/2$ . The input is a 5- $V_{PP}$  sinusoid. Output voltage is approximately 4.98  $V_{PP}$ .

Power-supply pins should be bypassed with 0.01- $\mu$ F ceramic capacitors.

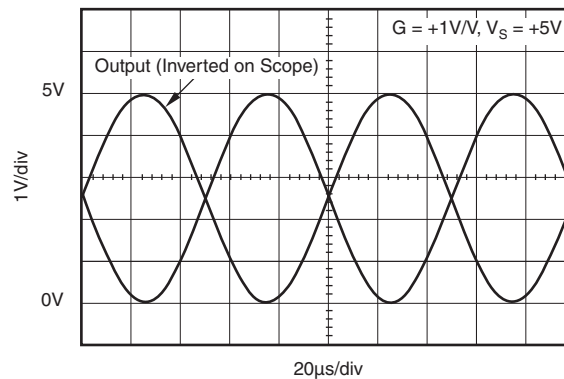

**Figure 1. Rail-to-Rail Input/Output**

### Operating Voltage

OPA2348 op amps are fully specified and tested from 2.5 V to 5.5 V. However, supply voltage may range from 2.1 V to 5.5 V. Parameters are tested over the specified supply range, a unique feature of the OPA2348. In addition, all temperature specifications apply from  $-40^{\circ}\text{C}$  to  $125^{\circ}\text{C}$ . Most behavior remains virtually unchanged throughout the full operating voltage range. Parameters that vary significantly with operating voltages or temperature are shown in the *Typical Characteristics*.

### Common-Mode Voltage Range

The input common-mode voltage range of the OPA2348 extends 200 mV beyond the supply rails. This is achieved with a complementary input stage—an N-channel input differential pair in parallel with a P-channel differential pair. The N-channel pair is active for input voltages close to the positive rail, typically  $(V+) - 1.2$  V to 300 mV above the positive supply, while the P-channel pair is on for inputs from 300 mV below the negative supply to approximately  $(V+) - 1.4$  V. There is a small transition region, typically  $(V+) - 1.4$  V to  $(V+) - 1.2$  V, in which both pairs are on. This 200-mV transition region, shown in Figure 2, can vary  $\pm 300$  mV with process variation. Thus, the transition region (both stages on) can range from  $(V+) - 1.7$  V to  $(V+) - 1.5$  V on the low end, up to  $(V+) - 1.1$  V to  $(V+) - 0.9$  V on the high end. Within the 200-mV transition region, PSRR, CMRR, offset voltage, offset drift, and THD may be degraded compared to operation outside this region.

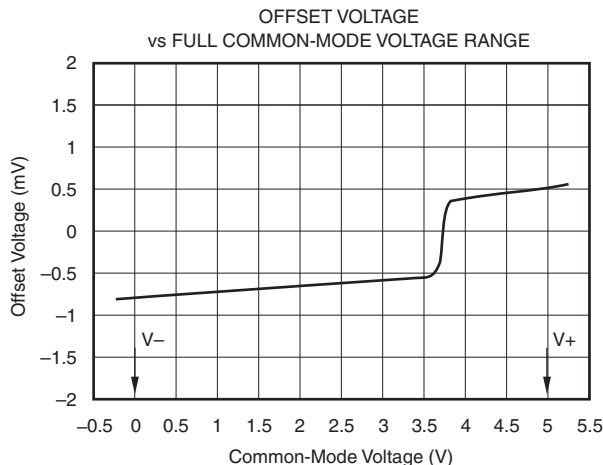

Figure 2. Behavior of Typical Transition Region at Room Temperature

### Rail-to-Rail Input

The input common-mode range extends from  $(V-) - 0.2\text{ V}$  to  $(V+) + 0.2\text{ V}$ . For normal operation, inputs should be limited to this range. The absolute maximum input voltage is 500 mV beyond the supplies. Inputs greater than the input common-mode range but less than the maximum input voltage, while not valid, do not cause any damage to the op amp. Unlike some other op amps, if input current is limited the inputs may go beyond the power supplies without phase inversion, as shown in Figure 3.

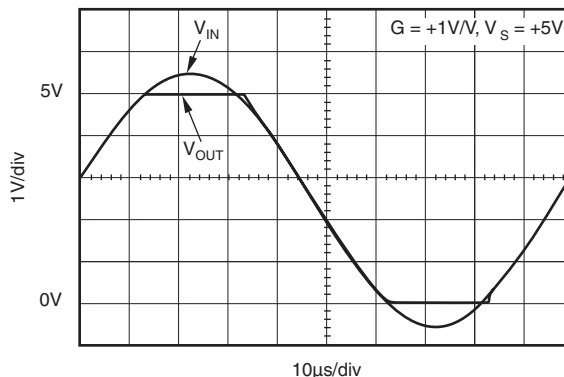

Figure 3. No Phase Inversion With Inputs Greater Than Power-Supply Voltage

Normally, input currents are 0.5 pA. However, large inputs (greater than 500 mV beyond the supply rails) can cause excessive current to flow in or out of the input pins. Therefore, as well as keeping the input voltage below the maximum rating, it is also important to limit the input current to less than 10 mA. This is easily accomplished with an input voltage resistor, as shown in Figure 4.

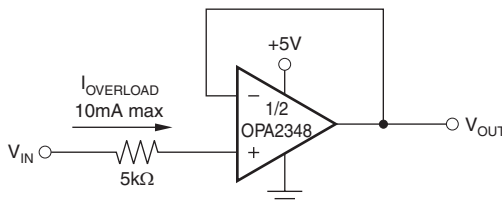

Figure 4. Input Current Protection for Voltages Exceeding the Supply Voltage



## Rail-to-Rail Output

A class AB output stage with common-source transistors is used to achieve rail-to-rail output. This output stage is capable of driving 5-k $\Omega$  loads connected to any potential between V+ and ground. For light resistive loads (>100 k $\Omega$ ), the output voltage can typically swing to within 18 mV from supply rail. With moderate resistive loads (10 k $\Omega$  to 50 k $\Omega$ ), the output voltage can typically swing to within 100 mV of the supply rails while maintaining high open-loop gain (see the typical characteristic "Output Voltage Swing vs Output Current").

## Capacitive Load and Stability

The OPA2348 in a unity-gain configuration can directly drive up to 250-pF pure capacitive load. Increasing the gain enhances the amplifier's ability to drive greater capacitive loads (see the typical characteristic "Small-Signal Overshoot vs Capacitive Load"). In unity-gain configurations, capacitive load drive can be improved by inserting a small (10  $\Omega$  to 20  $\Omega$ ) resistor,  $R_S$ , in series with the output, as shown in Figure 5. This significantly reduces ringing while maintaining dc performance for purely capacitive loads. However, if there is a resistive load in parallel with the capacitive load, a voltage divider is created, introducing a direct current (dc) error at the output and slightly reducing the output swing. The error introduced is proportional to the ratio  $R_S/R_L$  and is generally negligible.

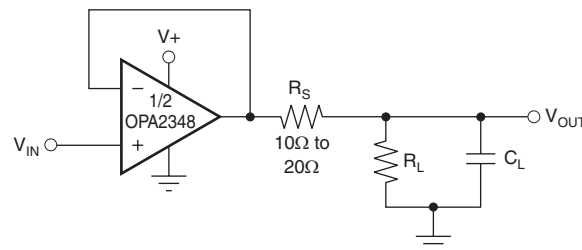

Figure 5. Series Resistor in Unity-Gain Buffer Configuration Improves Capacitive Load Drive

In unity-gain inverter configuration, phase margin can be reduced by the reaction between the capacitance at the op amp input and the gain setting resistors, thus degrading capacitive load drive. Best performance is achieved by using small-valued resistors. For example, when driving a 500-pF load, reducing the resistor values from 100 k $\Omega$  to 5 k $\Omega$  decreases overshoot from 55% to 13% (see the typical characteristic "Small-Signal Overshoot vs. Load Capacitance"). However, when large valued resistors cannot be avoided, a small (4 pF to 6 pF) capacitor,  $C_{FB}$ , can be inserted in the feedback, as shown in Figure 6. This significantly reduces overshoot by compensating the effect of capacitance,  $C_{IN}$ , which includes the amplifier's input capacitance and PC board parasitic capacitance.

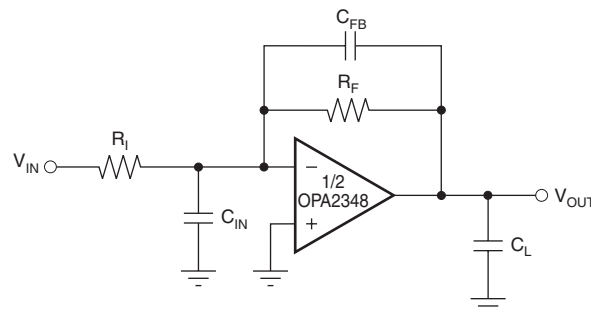

Figure 6. Improving Capacitive Load Drive

## Driving Analog-to-Digital Converters (ADCs)

The OPA2348 op amps are optimized for driving medium-speed sampling ADCs. The OPA2348 op amps buffer the ADC input capacitance and resulting charge injection while providing signal gain.

Figure 7 shows the OPA2348 in a basic noninverting configuration driving the ADS7822. The ADS7822 is a 12-bit, micropower sampling converter in the MSOP-8 package. When used with the low-power miniature packages of the OPA348, the combination is ideal for space-limited, low-power applications. In this configuration, an RC network at the ADC input can be used to provide for anti-aliasing filter and charge injection current.

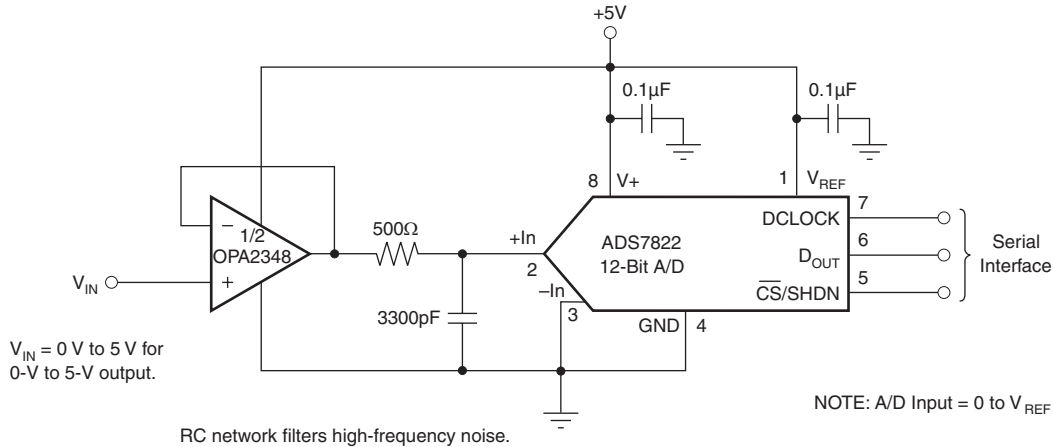
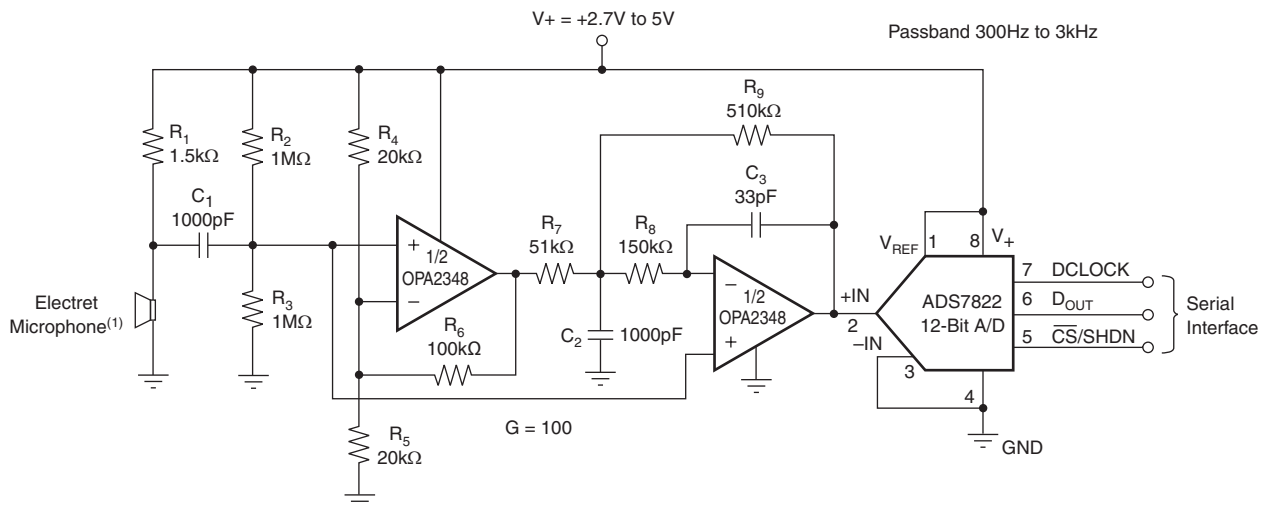

Figure 7. Noninverting Configuration Driving ADS7822

The OPA2348 can also be used in noninverting configuration driving ADS7822 in limited low-power applications. In this configuration, an RC network at the ADC input can be used to provide for antialiasing filter and charge injection current. See Figure 7 for the OPA2348 driving an ADS7822 in a speech bandpass filtered data acquisition system. This small low-cost solution provides the necessary amplification and signal conditioning to interface directly with an electret microphone. This circuit operates with  $V_S = 2.7\text{ V to }5\text{ V}$  with less than  $250\text{-}\mu\text{A}$  typical quiescent current.



(1) Electret microphone powered by  $R_1$ .

Figure 8. Speech Bandpass Filtered Data Acquisition System

**PACKAGING INFORMATION**

Orderable Device	Status <sup>(1)</sup>	Package Type	Package Drawing	Pins	Package Qty	Eco Plan <sup>(2)</sup>	Lead/Ball Finish	MSL Peak Temp <sup>(3)</sup>
OPA2348AQDRQ1	ACTIVE	SOIC	D	8	2500	Green (RoHS & no Sb/Br)	CU NIPDAU	Level-2-260C-1 YEAR
OPA4348AQPWRQ1	ACTIVE	TSSOP	PW	14	2500	Green (RoHS & no Sb/Br)	CU NIPDAU	Level-3-260C-168 HR

<sup>(1)</sup> The marketing status values are defined as follows:

**ACTIVE:** Product device recommended for new designs.

**LIFEBUY:** TI has announced that the device will be discontinued, and a lifetime-buy period is in effect.

**NRND:** Not recommended for new designs. Device is in production to support existing customers, but TI does not recommend using this part in a new design.

**PREVIEW:** Device has been announced but is not in production. Samples may or may not be available.

**OBsolete:** TI has discontinued the production of the device.

<sup>(2)</sup> Eco Plan - The planned eco-friendly classification: Pb-Free (RoHS), Pb-Free (RoHS Exempt), or Green (RoHS & no Sb/Br) - please check <http://www.ti.com/productcontent> for the latest availability information and additional product content details.

**TBD:** The Pb-Free/Green conversion plan has not been defined.

**Pb-Free (RoHS):** TI's terms "Lead-Free" or "Pb-Free" mean semiconductor products that are compatible with the current RoHS requirements for all 6 substances, including the requirement that lead not exceed 0.1% by weight in homogeneous materials. Where designed to be soldered at high temperatures, TI Pb-Free products are suitable for use in specified lead-free processes.

**Pb-Free (RoHS Exempt):** This component has a RoHS exemption for either 1) lead-based flip-chip solder bumps used between the die and package, or 2) lead-based die adhesive used between the die and leadframe. The component is otherwise considered Pb-Free (RoHS compatible) as defined above.

**Green (RoHS & no Sb/Br):** TI defines "Green" to mean Pb-Free (RoHS compatible), and free of Bromine (Br) and Antimony (Sb) based flame retardants (Br or Sb do not exceed 0.1% by weight in homogeneous material)

<sup>(3)</sup> MSL, Peak Temp. -- The Moisture Sensitivity Level rating according to the JEDEC industry standard classifications, and peak solder temperature.

**Important Information and Disclaimer:** The information provided on this page represents TI's knowledge and belief as of the date that it is provided. TI bases its knowledge and belief on information provided by third parties, and makes no representation or warranty as to the accuracy of such information. Efforts are underway to better integrate information from third parties. TI has taken and continues to take reasonable steps to provide representative and accurate information but may not have conducted destructive testing or chemical analysis on incoming materials and chemicals. TI and TI suppliers consider certain information to be proprietary, and thus CAS numbers and other limited information may not be available for release.

In no event shall TI's liability arising out of such information exceed the total purchase price of the TI part(s) at issue in this document sold by TI to Customer on an annual basis.

**OTHER QUALIFIED VERSIONS OF OPA2348-Q1, OPA4348-Q1 :**

- Catalog: [OPA2348](#), [OPA4348](#)

NOTE: Qualified Version Definitions:

- Catalog - TI's standard catalog product

**TAPE AND REEL INFORMATION**
**REEL DIMENSIONS**

**TAPE DIMENSIONS**

A0	Dimension designed to accommodate the component width
B0	Dimension designed to accommodate the component length
K0	Dimension designed to accommodate the component thickness
W	Overall width of the carrier tape
P1	Pitch between successive cavity centers

**TAPE AND REEL INFORMATION**

\*All dimensions are nominal

Device	Package Type	Package Drawing	Pins	SPQ	Reel Diameter (mm)	Reel Width W1 (mm)	A0 (mm)	B0 (mm)	K0 (mm)	P1 (mm)	W (mm)	Pin1 Quadrant
OPA2348AQDRQ1	SOIC	D	8	2500	330.0	12.4	6.4	5.2	2.1	8.0	12.0	Q1
OPA4348AQPWRQ1	TSSOP	PW	14	2500	330.0	12.4	6.9	5.6	1.6	8.0	12.0	Q1

**TAPE AND REEL BOX DIMENSIONS**



\*All dimensions are nominal

Device	Package Type	Package Drawing	Pins	SPQ	Length (mm)	Width (mm)	Height (mm)
OPA2348AQDRQ1	SOIC	D	8	2500	367.0	367.0	35.0
OPA4348AQPWRQ1	TSSOP	PW	14	2500	367.0	367.0	35.0

PW (R-PDSO-G14)

PLASTIC SMALL OUTLINE



- NOTES:
- A. All linear dimensions are in millimeters. Dimensioning and tolerancing per ASME Y14.5M-1994.
  - B. This drawing is subject to change without notice.
  - C. Body length does not include mold flash, protrusions, or gate burrs. Mold flash, protrusions, or gate burrs shall not exceed 0,15 each side.
  - D. Body width does not include interlead flash. Interlead flash shall not exceed 0,25 each side.
  - E. Falls within JEDEC MO-153

PW (R-PDSO-G14)

PLASTIC SMALL OUTLINE



- NOTES:
- All linear dimensions are in millimeters.
  - This drawing is subject to change without notice.
  - Publication IPC-7351 is recommended for alternate designs.
  - Laser cutting apertures with trapezoidal walls and also rounding corners will offer better paste release. Customers should contact their board assembly site for stencil design recommendations. Refer to IPC-7525 for other stencil recommendations.
  - Customers should contact their board fabrication site for solder mask tolerances between and around signal pads.

D (R-PDSO-G8)

PLASTIC SMALL OUTLINE



- NOTES:
- A. All linear dimensions are in inches (millimeters).
  - B. This drawing is subject to change without notice.
  - Body length does not include mold flash, protrusions, or gate burrs. Mold flash, protrusions, or gate burrs shall not exceed 0.006 (0,15) each side.
  - Body width does not include interlead flash. Interlead flash shall not exceed 0.017 (0,43) each side.
  - E. Reference JEDEC MS-012 variation AA.



D (R-PDSO-G8)

PLASTIC SMALL OUTLINE



- NOTES:
- All linear dimensions are in millimeters.
  - This drawing is subject to change without notice.
  - Publication IPC-7351 is recommended for alternate designs.
  - Laser cutting apertures with trapezoidal walls and also rounding corners will offer better paste release. Customers should contact their board assembly site for stencil design recommendations. Refer to IPC-7525 for other stencil recommendations.
  - Customers should contact their board fabrication site for solder mask tolerances between and around signal pads.

## IMPORTANT NOTICE

Texas Instruments Incorporated and its subsidiaries (TI) reserve the right to make corrections, enhancements, improvements and other changes to its semiconductor products and services per JESD46, latest issue, and to discontinue any product or service per JESD48, latest issue. Buyers should obtain the latest relevant information before placing orders and should verify that such information is current and complete. All semiconductor products (also referred to herein as "components") are sold subject to TI's terms and conditions of sale supplied at the time of order acknowledgment.

TI warrants performance of its components to the specifications applicable at the time of sale, in accordance with the warranty in TI's terms and conditions of sale of semiconductor products. Testing and other quality control techniques are used to the extent TI deems necessary to support this warranty. Except where mandated by applicable law, testing of all parameters of each component is not necessarily performed.

TI assumes no liability for applications assistance or the design of Buyers' products. Buyers are responsible for their products and applications using TI components. To minimize the risks associated with Buyers' products and applications, Buyers should provide adequate design and operating safeguards.

TI does not warrant or represent that any license, either express or implied, is granted under any patent right, copyright, mask work right, or other intellectual property right relating to any combination, machine, or process in which TI components or services are used. Information published by TI regarding third-party products or services does not constitute a license to use such products or services or a warranty or endorsement thereof. Use of such information may require a license from a third party under the patents or other intellectual property of the third party, or a license from TI under the patents or other intellectual property of TI.

Reproduction of significant portions of TI information in TI data books or data sheets is permissible only if reproduction is without alteration and is accompanied by all associated warranties, conditions, limitations, and notices. TI is not responsible or liable for such altered documentation. Information of third parties may be subject to additional restrictions.

Resale of TI components or services with statements different from or beyond the parameters stated by TI for that component or service voids all express and any implied warranties for the associated TI component or service and is an unfair and deceptive business practice. TI is not responsible or liable for any such statements.

Buyer acknowledges and agrees that it is solely responsible for compliance with all legal, regulatory and safety-related requirements concerning its products, and any use of TI components in its applications, notwithstanding any applications-related information or support that may be provided by TI. Buyer represents and agrees that it has all the necessary expertise to create and implement safeguards which anticipate dangerous consequences of failures, monitor failures and their consequences, lessen the likelihood of failures that might cause harm and take appropriate remedial actions. Buyer will fully indemnify TI and its representatives against any damages arising out of the use of any TI components in safety-critical applications.

In some cases, TI components may be promoted specifically to facilitate safety-related applications. With such components, TI's goal is to help enable customers to design and create their own end-product solutions that meet applicable functional safety standards and requirements. Nonetheless, such components are subject to these terms.

No TI components are authorized for use in FDA Class III (or similar life-critical medical equipment) unless authorized officers of the parties have executed a special agreement specifically governing such use.

Only those TI components which TI has specifically designated as military grade or "enhanced plastic" are designed and intended for use in military/aerospace applications or environments. Buyer acknowledges and agrees that any military or aerospace use of TI components which have **not** been so designated is solely at the Buyer's risk, and that Buyer is solely responsible for compliance with all legal and regulatory requirements in connection with such use.

TI has specifically designated certain components which meet ISO/TS16949 requirements, mainly for automotive use. Components which have not been so designated are neither designed nor intended for automotive use; and TI will not be responsible for any failure of such components to meet such requirements.

### Products

Audio	<a href="http://www.ti.com/audio">www.ti.com/audio</a>
Amplifiers	<a href="http://amplifier.ti.com">amplifier.ti.com</a>
Data Converters	<a href="http://dataconverter.ti.com">dataconverter.ti.com</a>
DLP® Products	<a href="http://www.dlp.com">www.dlp.com</a>
DSP	<a href="http://dsp.ti.com">dsp.ti.com</a>
Clocks and Timers	<a href="http://www.ti.com/clocks">www.ti.com/clocks</a>
Interface	<a href="http://interface.ti.com">interface.ti.com</a>
Logic	<a href="http://logic.ti.com">logic.ti.com</a>
Power Mgmt	<a href="http://power.ti.com">power.ti.com</a>
Microcontrollers	<a href="http://microcontroller.ti.com">microcontroller.ti.com</a>
RFID	<a href="http://www.ti-rfid.com">www.ti-rfid.com</a>
OMAP Applications Processors	<a href="http://www.ti.com/omap">www.ti.com/omap</a>
Wireless Connectivity	<a href="http://www.ti.com/wirelessconnectivity">www.ti.com/wirelessconnectivity</a>

### Applications

Automotive and Transportation	<a href="http://www.ti.com/automotive">www.ti.com/automotive</a>
Communications and Telecom	<a href="http://www.ti.com/communications">www.ti.com/communications</a>
Computers and Peripherals	<a href="http://www.ti.com/computers">www.ti.com/computers</a>
Consumer Electronics	<a href="http://www.ti.com/consumer-apps">www.ti.com/consumer-apps</a>
Energy and Lighting	<a href="http://www.ti.com/energy">www.ti.com/energy</a>
Industrial	<a href="http://www.ti.com/industrial">www.ti.com/industrial</a>
Medical	<a href="http://www.ti.com/medical">www.ti.com/medical</a>
Security	<a href="http://www.ti.com/security">www.ti.com/security</a>
Space, Avionics and Defense	<a href="http://www.ti.com/space-avionics-defense">www.ti.com/space-avionics-defense</a>
Video and Imaging	<a href="http://www.ti.com/video">www.ti.com/video</a>

### TI E2E Community

[e2e.ti.com](http://e2e.ti.com)