

SN54LS280, SN54S280, SN74LS280, SN74S280 9-BIT ODD/EVEN PARITY GENERATORS/CHECKERS

SDLS152 – DECEMBER 1972 – REVISED MARCH 1988

- Generates Either Odd or Even Parity for Nine Data Lines
- Cascadable for n-Bits
- Can Be Used to Upgrade Existing Systems using MSI Parity Circuits
- Typical Data-to-Output Delay of Only 14 ns for 'S280 and 33 ns for 'LS280
- Typical Power Dissipation:
'LS280 . . . 80 mW
'S280 . . . 335 mW

SN54LS280, SN54S280 . . . J OR W PACKAGE
SN74LS280, SN74S280 . . . D OR N PACKAGE

(TOP VIEW)

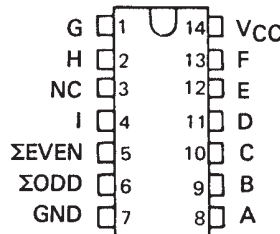

SN54LS280, SN54S280 . . . FK PACKAGE

(TOP VIEW)

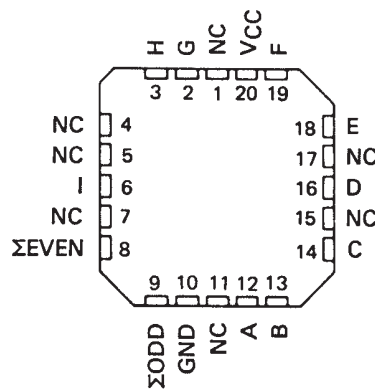

FUNCTION TABLE

NUMBER OF INPUTS A THRU I THAT ARE HIGH	OUTPUTS	
	Σ EVEN	Σ ODD
0, 2, 4, 6, 8	H	L
1, 3, 5, 7, 9	L	H

H = high level, L = low level

logic symbol†

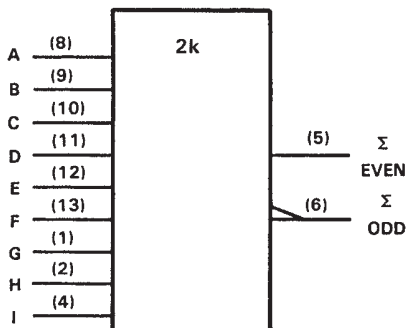

†This symbol is in accordance with ANSI/IEEE Std. 91-1984 and IEC Publication 617-12.

Pin numbers shown are for D, J, N, and W packages.

description

These universal, monolithic, nine-bit parity generators/checkers utilize Schottky-clamped TTL high-performance circuitry and feature odd/even outputs to facilitate operation of either odd or even parity application. The word-length capability is easily expanded by cascading as shown under typical application data.

Series 54LS/74LS and Series 54S/74S parity generators/checkers offer the designer a trade-off between reduced power consumption and high performance. These devices can be used to upgrade the performance of most systems utilizing the '180 parity generator/checker. Although the 'LS280 and 'S280 are implemented without expander inputs, the corresponding function is provided by the availability of an input at pin 4 and the absence of any internal connection at pin 3. This permits the 'LS280 and 'S280 to be substituted for the '180 in existing designs to produce an identical function even if 'LS280's and 'S280's are mixed with existing '180's.

These devices are fully compatible with most other TTL circuits. All 'LS280 and 'S280 inputs are buffered to lower the drive requirements to one Series 54LS/74LS or Series 54S/74S standard load, respectively.

SN54LS280, SN54S280, SN74LS280, SN74S280 9-BIT ODD/EVEN PARITY GENERATORS/CHECKERS

SDLS152 – DECEMBER 1972 – REVISED MARCH 1988

recommended operating conditions

	SN54LS280			SN74LS280			UNIT
	MIN	NOM	MAX	MIN	NOM	MAX	
V _{CC} Supply voltage	4.5	5	5.5	4.75	5	5.25	V
V _{IH} High-level input voltage	2			2			V
V _{IL} Low-level input voltage			0.7			0.8	V
I _{OH} High-level output current			-0.4			-0.4	mA
I _{OL} Low-level output current			4			8	mA
T _A Operating free-air temperature	-55		125	0		70	°C

electrical characteristics over recommended operating free-air temperature range (unless otherwise noted)

PARAMETER	TEST CONDITIONS	SN54LS280			SN74LS280			UNIT
		MIN	TYP†	MAX	MIN	TYP†	MAX	
V _{IK}	V _{CC} = MIN, I _I = -18 mA			-1.5			-1.5	V
V _{OH}	V _{CC} = MIN, V _{IH} = 2 V, V _{IL} = MAX, I _{OH} = -0.4 mA	2.5	3.4		2.7	3.4		V
V _{OL}	V _{CC} = MIN, V _{IH} = 2 V, V _{IL} = MAX	I _{OL} = 4 mA		0.25	0.4	0.25 0.4		V
		I _{OL} = 8 mA				0.35 0.5		
I _I	V _{CC} = MAX, V _I = 7 V			0.1			0.1	mA
I _{IH}	V _{CC} = MAX, V _I = 2.7 V			20			20	μA
I _{IL}	V _{CC} = MAX, V _I = 0.4 V			-0.4			-0.4	mA
I _{OS} §	V _{CC} = MAX	-20		-100	-20		-100	mA
I _{CC}	V _{CC} = MAX, See Note 2		16	27		16	27	mA

† For conditions shown as MIN or MAX, use the appropriate value specified under recommended operating conditions.

‡ All typical values are at V_{CC} = 5 V, T_A = 25°C.

§ Not more than one output should be shorted at a time and duration of the short circuit should not exceed one second.

NOTE 2: I_{CC} is measured with all inputs grounded and all outputs open.

switching characteristics, V_{CC} = 5 V, T_A = 25°C

PARAMETER¶	FROM (INPUT)	TO (OUTPUT)	TEST CONDITIONS	MIN	TYP	MAX	UNIT
t _{PLH}	Data	Σ Even	C _L = 15 pF, R _L = 2 kΩ, Inputs not under test at 0 V, See Note 3		33	50	ns
t _{PHL}					29	45	
t _{PLH}	Data	Σ Odd			23	35	ns
t _{PHL}					31	50	

¶ t_{PLH} ≡ propagation delay time, low-to-high-level output; t_{PHL} ≡ propagation delay time, high-to-low-level output

NOTE 3: Load circuits and voltage waveforms are shown in Section 1.

SN54LS280, SN54S280, SN74LS280, SN74S280 9-BIT ODD/EVEN PARITY GENERATORS/CHECKERS

SDLS152 – DECEMBER 1972 – REVISED MARCH 1988

recommended operating conditions

	SN54S280			SN74S280			UNIT
	MIN	NOM	MAX	MIN	NOM	MAX	
Supply voltage, V_{CC}	4.5	5	5.5	4.75	5	5.25	V
High-level output current, I_{OH}			-1			-1	mA
Low-level output current, I_{OL}			20			20	mA
Operating free-air temperature, T_A	-55		125	0		70	°C

electrical characteristics over recommended operating free-air temperature range (unless otherwise noted)

PARAMETER	TEST CONDITIONS†	MIN	TYP‡	MAX	UNIT
V_{IH} High-level input voltage		2			V
V_{IL} Low-level input voltage				0.8	V
V_{IK} Input clamp voltage	$V_{CC} = \text{MIN}, I_I = -18 \text{ mA}$			-1.2	V
V_{OH} High-level output voltage	$V_{CC} = \text{MIN}, V_{IH} = 2 \text{ V},$ $V_{IL} = 0.8 \text{ V}, I_{OH} = -1 \text{ mA}$	SN54S'	2.5	3.4	V
		SN74S'	2.7	3.4	
V_{OL} Low-level output voltage	$V_{CC} = \text{MIN}, V_{IH} = 2 \text{ V},$ $V_{IL} = 0.8 \text{ V}, I_{OL} = 20 \text{ mA}$			0.5	V
I_I Input current at maximum input voltage	$V_{CC} = \text{MAX}, V_I = 5.5 \text{ V}$			1	mA
I_{IH} High-level input current	$V_{CC} = \text{MAX}, V_I = 2.7 \text{ V}$			50	μA
I_{IL} Low-level input current	$V_{CC} = \text{MAX}, V_I = 0.5 \text{ V}$			-2	mA
I_{OS} Short-circuit output current§	$V_{CC} = \text{MAX}$	-40		-100	mA
I_{CC} Supply current	$V_{CC} = \text{MAX},$ See Note 2	SN54S280	67	99	mA
		SN74S280	67	105	
	$V_{CC} = \text{MAX}, T_A = 125^\circ \text{C},$ See Note 2	SN54S280N		94	mA

† For conditions shown as MIN or MAX, use the appropriate value specified under recommended operating conditions.

‡ All typical values are at $V_{CC} = 5 \text{ V}, T_A = 25^\circ \text{C}$.

§ Not more than one output should be shorted at a time and duration of the short circuit should not exceed one second.

NOTE 2: I_{CC} is measured with all inputs grounded and all outputs open.

switching characteristics, $V_{CC} = 5 \text{ V}, T_A = 25^\circ \text{C}$

PARAMETER¶	FROM (INPUT)	TO (OUTPUT)	TEST CONDITIONS	MIN	TYP	MAX	UNIT
t_{PLH}	Data	Σ Even	$C_L = 15 \text{ pF}, R_L = 280 \Omega,$ See Note 3		14	21	ns
t_{PHL}					11.5	18	
t_{PLH}	Data	Σ Odd			14	21	ns
t_{PHL}					11.5	18	

¶ t_{PLH} = propagation delay time, low-to-high-level output; t_{PHL} = propagation delay time, high-to-low-level output

NOTE 3: Load circuits and voltage waveforms are shown in Section 1.



SN54LS280, SN54S280, SN74LS280, SN74S280 9-BIT ODD/EVEN PARITY GENERATORS/CHECKERS

SDLS152 - DECEMBER 1972 - REVISED MARCH 1988

logic diagram (positive logic)

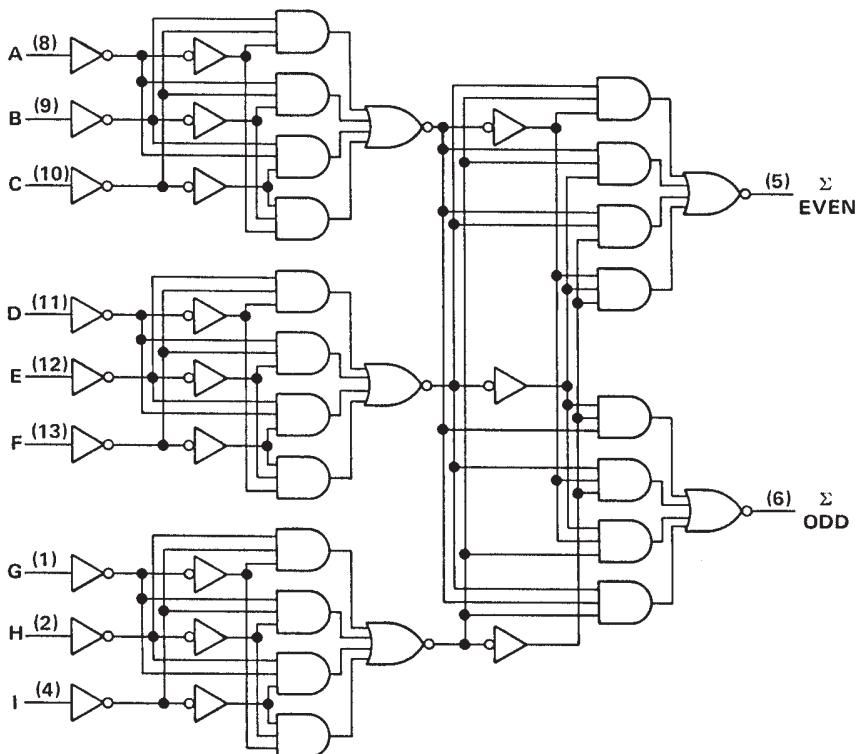

Pin numbers shown are for D, J, N, and W packages.

TYPICAL APPLICATION DATA

25-LINE PARITY/GENERATOR CHECKER

Three 'LS280's or 'S280's can be used to implement a 25-line parity generator/checker. This arrangement will provide parity in typically 75 or 25 nanoseconds respectively.

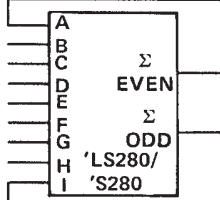
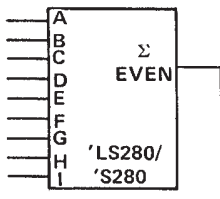

H = EVEN
L = ODD
H = ODD
L = EVEN

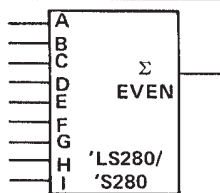

As an alternative, the outputs of two or three parity generators/checkers can be decoded with a 2-input ('S86 or 'LS86) or 3-input ('S135) exclusive-OR gate for 18- or 27-line parity applications.

81-LINE PARITY/GENERATOR CHECKER

Longer word lengths can be implemented by cascading 'LS280's or 'S280's. As shown here, parity can be generated for word lengths up to 81 bits in typically 75 or 25 nanoseconds respectively.

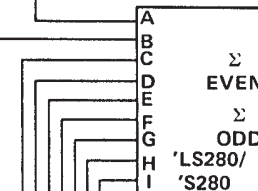
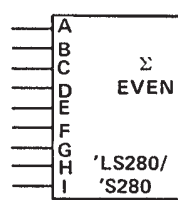
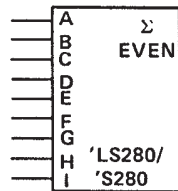
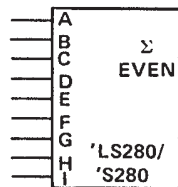

H = EVEN
L = ODD
H = ODD
L = EVEN

TO OTHER
'LS280/
'S280



IMPORTANT NOTICE

Texas Instruments and its subsidiaries (TI) reserve the right to make changes to their products or to discontinue any product or service without notice, and advise customers to obtain the latest version of relevant information to verify, before placing orders, that information being relied on is current and complete. All products are sold subject to the terms and conditions of sale supplied at the time of order acknowledgement, including those pertaining to warranty, patent infringement, and limitation of liability.

TI warrants performance of its semiconductor products to the specifications applicable at the time of sale in accordance with TI's standard warranty. Testing and other quality control techniques are utilized to the extent TI deems necessary to support this warranty. Specific testing of all parameters of each device is not necessarily performed, except those mandated by government requirements.

CERTAIN APPLICATIONS USING SEMICONDUCTOR PRODUCTS MAY INVOLVE POTENTIAL RISKS OF DEATH, PERSONAL INJURY, OR SEVERE PROPERTY OR ENVIRONMENTAL DAMAGE ("CRITICAL APPLICATIONS"). TI SEMICONDUCTOR PRODUCTS ARE NOT DESIGNED, AUTHORIZED, OR WARRANTED TO BE SUITABLE FOR USE IN LIFE-SUPPORT DEVICES OR SYSTEMS OR OTHER CRITICAL APPLICATIONS. INCLUSION OF TI PRODUCTS IN SUCH APPLICATIONS IS UNDERSTOOD TO BE FULLY AT THE CUSTOMER'S RISK.

In order to minimize risks associated with the customer's applications, adequate design and operating safeguards must be provided by the customer to minimize inherent or procedural hazards.

TI assumes no liability for applications assistance or customer product design. TI does not warrant or represent that any license, either express or implied, is granted under any patent right, copyright, mask work right, or other intellectual property right of TI covering or relating to any combination, machine, or process in which such semiconductor products or services might be or are used. TI's publication of information regarding any third party's products or services does not constitute TI's approval, warranty or endorsement thereof.