

THS4001 270-MHz HIGH-SPEED AMPLIFIER

SLOS206A– DECEMBER 1997 – REVISED MARCH 1999

- **Very High Speed**
 - 270 MHz Bandwidth (Gain = 1, –3 dB)
 - 400 V/μsec Slew Rate
 - 40-ns Settling Time (0.1%)
- **High Output Drive, $I_O = 100$ mA**
- **Excellent Video Performance**
 - 60 MHz Bandwidth (0.1 dB, G = 1)
 - 0.04% Differential Gain
 - 0.15° Differential Phase
- **Very Low Distortion**
 - THD = –72 dBc at f = 1 MHz
- **Wide Range of Power Supplies**
 $V_{CC} = \pm 2.5$ V to ± 15 V,
 $I_{CC} = 7.5$ mA
- **Evaluation Module Available**

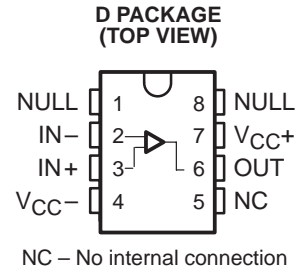

description

The THS4001 is a very high-performance, voltage-feedback operational amplifier especially suited for a wide range of video applications. The device is specified to operate over a wide range of supply voltages from ± 15 V to ± 2.5 V. With a bandwidth of 270 MHz, a slew rate of over 400 V/μs, and settling times of less than 30 ns, the THS4001 offers the unique combination of high performance in an easy to use voltage feedback configuration over a wide range of power supply voltages.

The THS4001 is stable at all gains for both inverting and noninverting configurations. It has a high output drive capability of 100 mA and draws only 7.5 mA of quiescent current. Excellent professional video results can be obtained with the differential gain/phase performance of 0.04%/0.15° and 0.1 dB gain flatness to 60 MHz. For applications requiring low distortion, the THS4001 is ideally suited with total harmonic distortion of –72 dBc at f = 1 MHz.

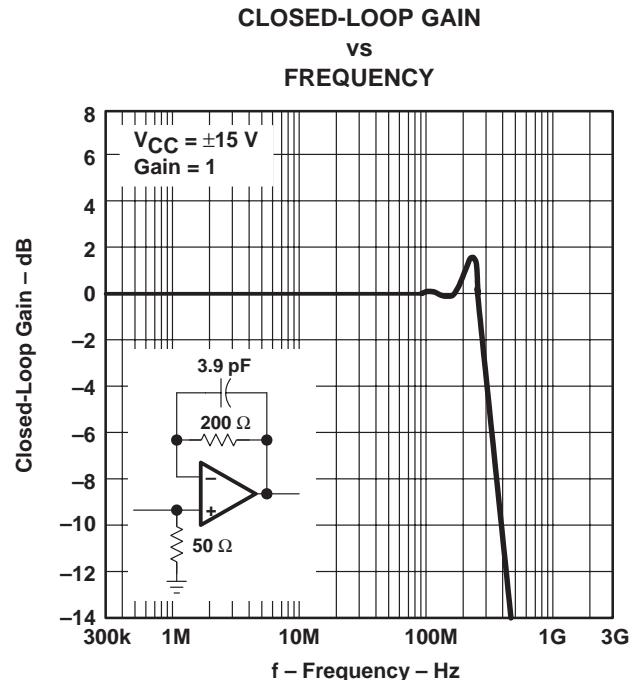

HIGH-SPEED AMPLIFIER FAMILY

DEVICE	ARCH.		SUPPLY VOLTAGE			BW (MHz)	SR (V/μs)	THD f = 1 MHz (dB)	t _s 0.1% (ns)	DIFF. GAIN	DIFF. PHASE	V _n (nV/√Hz)
	VFB	CFB	5 V	±5 V	±15 V							
THS3001		•		•	•	420	6500	–96	40	0.01%	0.02°	1.6
THS4001	•		•	•	•	270	400	–72	40	0.04%	0.15°	12.5
THS4031/32	•			•	•	100	100	–72	60	0.02%	0.03°	1.6
THS4061/62	•			•	•	180	400	–72	40	0.02%	0.02°	14.5



Please be aware that an important notice concerning availability, standard warranty, and use in critical applications of Texas Instruments semiconductor products and disclaimers thereto appears at the end of this data sheet.

PRODUCTION DATA information is current as of publication date. Products conform to specifications per the terms of Texas Instruments standard warranty. Production processing does not necessarily include testing of all parameters.

**TEXAS
INSTRUMENTS**

POST OFFICE BOX 655303 • DALLAS, TEXAS 75265

Copyright © 1999, Texas Instruments Incorporated

THS4001

270-MHz HIGH-SPEED AMPLIFIER

SLOS206A– DECEMBER 1997 – REVISED MARCH 1999

AVAILABLE OPTIONS

T _A	PACKAGED DEVICES	
	SMALL OUTLINE† (D)	EVALUATION MODULE
0°C to 70°C	THS4001CD	THS4001EVM
–40°C to 85°C	THS4001ID	—

† The D packages are available taped and reeled. Add an R suffix to the device type (i.e., THS4001CDR).

symbol

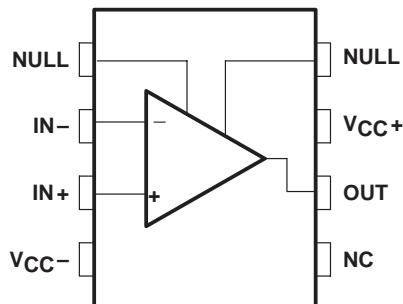

absolute maximum ratings over operating free-air temperature (unless otherwise noted)†

Supply voltage, V _{CC-} to V _{CC+}	33 V
Input voltage, V _I	±V _{CC}
Output current, I _O	175 mA
Differential input voltage, V _{ID}	±4 V
Continuous total power dissipation	See Dissipation Ratings Table
Operating free air temperature, T _A : C suffix	0°C to 70 °C
I suffix	–40°C to 85 °C
Storage temperature, T _{stg}	–65°C to 150 °C
Lead temperature 1,6 mm (1/16 Inch) from case for 10 seconds	300°C

† Stresses beyond those listed under “absolute maximum ratings” may cause permanent damage to the device. These are stress ratings only, and functional operation of the device at these or any other conditions beyond those indicated under “recommended operating conditions” is not implied. Exposure to absolute-maximum-rated conditions for extended periods may affect device reliability.

DISSIPATION RATING TABLE

PACKAGE	T _A ≤ 25°C POWER RATING	DERATING FACTOR ABOVE T _A = 25°C	T _A = 70°C POWER RATING	T _A = 85°C POWER RATING
D	740 mW	6 mW/°C	475 mW	385 mW



CAUTION: The THS4001 provides ESD protection circuitry. However, permanent damage can still occur if this device is subjected to high-energy electrostatic discharges. Proper ESD precautions are recommended to avoid any performance degradation or loss of functionality

recommended operating conditions

		MIN	TYP	MAX	UNIT
Supply voltage, V_{CC}	Dual supply	± 2.5		± 16	V
	Single supply	5		32	
Quiescent current, I_{CC}	± 15 V		7.8	9.5	mA
	± 5 V, ± 2.5 V		6.7	8	
Operating free-air temperature, T_A	C suffix	0		70	$^{\circ}$ C
	I suffix	-40		85	

electrical characteristics, $V_{CC} = \pm 15$ V, $R_L = 150 \Omega$, $T_A = 25^{\circ}$ C (unless otherwise noted)

PARAMETER	TEST CONDITIONS	V_{CC}	MIN	TYP	MAX	UNIT
Differential gain error	Gain = 2, $R_L = 150 \Omega$, $f = 3.58$ MHz	± 15 V		0.04%		
		± 5 V		0.01%		
Differential phase error		± 15 V		0.15 $^{\circ}$		
		± 5 V		0.08 $^{\circ}$		
V_{IO} Input offset voltage	$T_A = 25^{\circ}$ C	± 15 V,		2	8	mV
	$T_A = \text{full range}$	± 5 V			10	
I_{IB} Input bias current	$T_A = 25^{\circ}$ C	± 15 V,		2.6	5	μ A
	$T_A = \text{full range}$	± 5 V			6	
I_{OS} Input offset current	$T_A = 25^{\circ}$ C	± 15 V,		35	200	nA
	$T_A = \text{full range}$	± 5 V			500	
Open-loop gain	$V_O = \pm 10$ V, $R_L = 1$ k Ω	$T_A = 25^{\circ}$ C	± 15 V	5	10	V/mV
		$T_A = \text{full range}$		3		
	$V_O = \pm 2.5$ V, $R_L = 500 \Omega$	$T_A = 25^{\circ}$ C	± 5 V	3	6	
		$T_A = \text{full range}$		2		
CMRR Common-mode rejection ratio	$V_{(CM)} = \pm 12$ V	$T_A = 25^{\circ}$ C	± 15 V	85	100	dB
		$T_A = \text{full range}$		75		
PSRR Power supply rejection ratio	$T_A = 25^{\circ}$ C	± 15 V,		75	85	dB
	$T_A = \text{full range}$	± 5 V		70		
V_{ICR} Common-mode input voltage range		± 15 V	13.5 to -13	14.8 to -14		V
		± 5 V	3.6 to -2.7	4.4 to -3.6		
V_O Output voltage swing	$R_L = 500 \Omega$	± 15 V	± 13	± 13.5		V
		± 5 V	± 3.3	± 3.8		
		± 2.5 V	± 0.8	± 1.3		
I_O Output current		± 15 V	50	100		mA
		± 5 V	50	100		
		± 2.5 V	50	100		
THD Total harmonic distortion	$V_I = 1$ V _(PP) , $f = 1$ MHz	± 15 V		-72		dBc
R_I Input resistance				10		M Ω
C_I Input capacitance				1.5		pF
R_O Output resistance	Open loop			10		Ω

THS4001

270-MHz HIGH-SPEED AMPLIFIER

SLOS206A– DECEMBER 1997 – REVISED MARCH 1999

operating characteristics, $V_{CC} = \pm 15\text{ V}$, $R_L = 150\ \Omega$, $T_A = 25^\circ\text{C}$ (unless otherwise noted)

PARAMETER	TEST CONDITIONS	V_{CC}	MIN	TYP	MAX	UNIT
Slew rate	Gain = -1	$\pm 15\text{ V}$		400		$\text{V}/\mu\text{s}$
		$\pm 5\text{ V}$		400		
		$\pm 2.5\text{ V}$		350		
Settling time to 0.1%	10 V step (0 to 10 V), Gain = -1	$\pm 15\text{ V}$		40		ns
	-2.5 V to 2.5 V step, Gain = -1	$\pm 5\text{ V}$		30		
-3 dB Bandwidth	Gain = +1, $R_f = 150\ \Omega$	$\pm 15\text{ V}$		270		MHz
		$\pm 5\text{ V}$		220		
		$\pm 2.5\text{ V}$		180		
	Gain = -1, $R_f = 150\ \Omega$	$\pm 15\text{ V}$		80		MHz
		$\pm 5\text{ V}$		75		
		$\pm 2.5\text{ V}$		70		
Bandwidth for 0.1 dB flatness	Gain = +1	$\pm 15\text{ V}$		60		MHz
		$\pm 5\text{ V}$		50		
		$\pm 2.5\text{ V}$		40		
V_n	Equivalent input noise voltage	$f = 10\text{ kHz}$	$\pm 15\text{ V}$, $\pm 5\text{ V}$	12.5		$\text{nV}/\sqrt{\text{Hz}}$
I_n	Equivalent input noise current	$f = 10\text{ kHz}$	$\pm 15\text{ V}$, $\pm 5\text{ V}$	1.5		$\text{pA}/\sqrt{\text{Hz}}$

TYPICAL CHARACTERISTICS

Table of Graphs

		FIGURE	
I_{IB}	Input bias current	vs Free-air temperature	1
V_{IO}	Input offset voltage	vs Free-air temperature	2
	Open-loop gain	vs Frequency	3
	Phase	vs Frequency	3
	Differential gain	vs DC voltage	4, 5
	Differential phase	vs DC voltage	4, 5
	Closed-loop gain	vs Frequency	6, 7
CMRR	Common-mode rejection ratio	vs Frequency	8
PSRR	Power-supply rejection ratio	vs Frequency	9
		vs Free-air temperature	10
$V_{O(PP)}$	Output voltage swing	vs Supply voltage	11
		vs Load resistance	12
	Bandwidth (-3 dB)	vs Feedback resistance	13, 14
I_{CC}	Supply current	vs Supply voltage	15
		vs Free-air temperature	16
E_{nv}	Noise spectral density	vs Frequency	17
THD	Total harmonic distortion	vs Frequency	18

TYPICAL CHARACTERISTICS

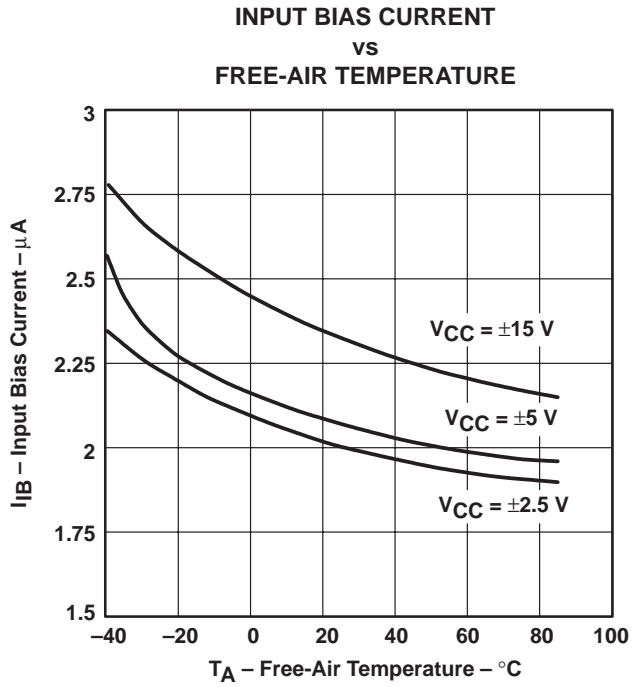

Figure 1

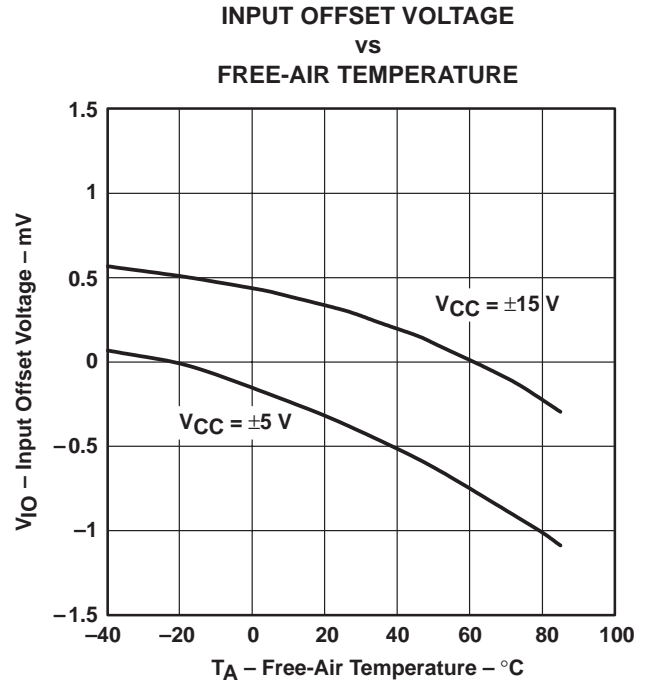

Figure 2

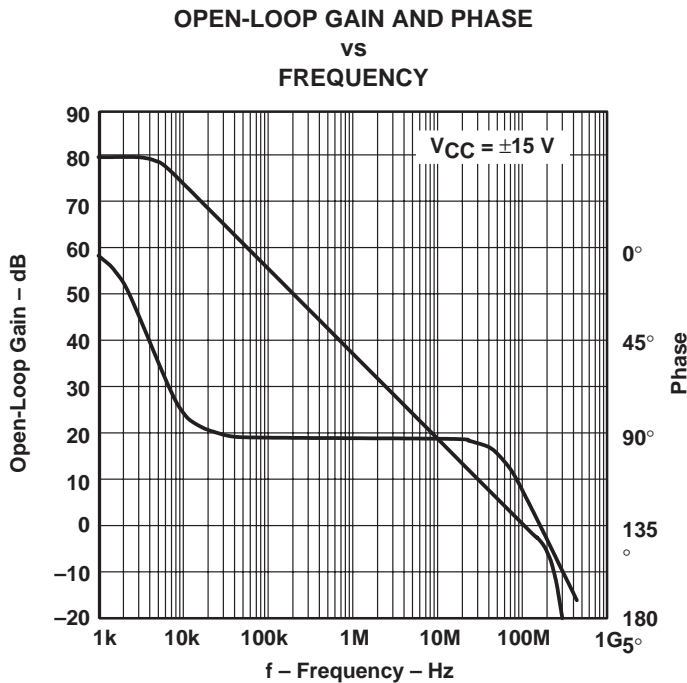

Figure 3

TYPICAL CHARACTERISTICS

DIFFERENTIAL GAIN AND
DIFFERENTIAL PHASE
vs
DC VOLTAGE

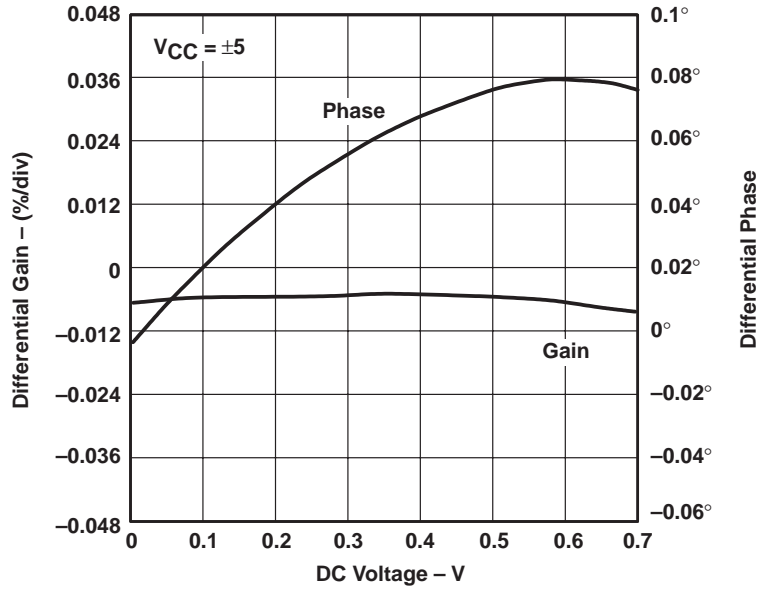

Figure 4

DIFFERENTIAL GAIN AND
DIFFERENTIAL PHASE
vs
DC VOLTAGE

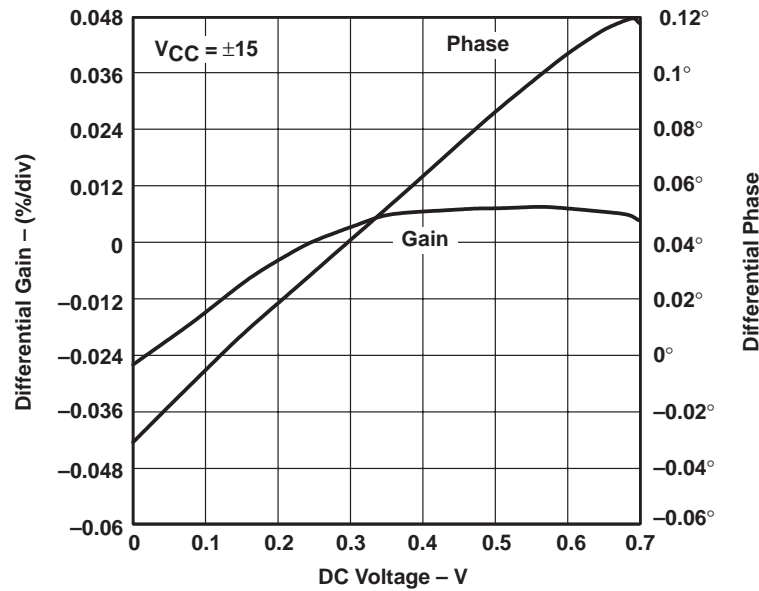

Figure 5

TYPICAL CHARACTERISTICS

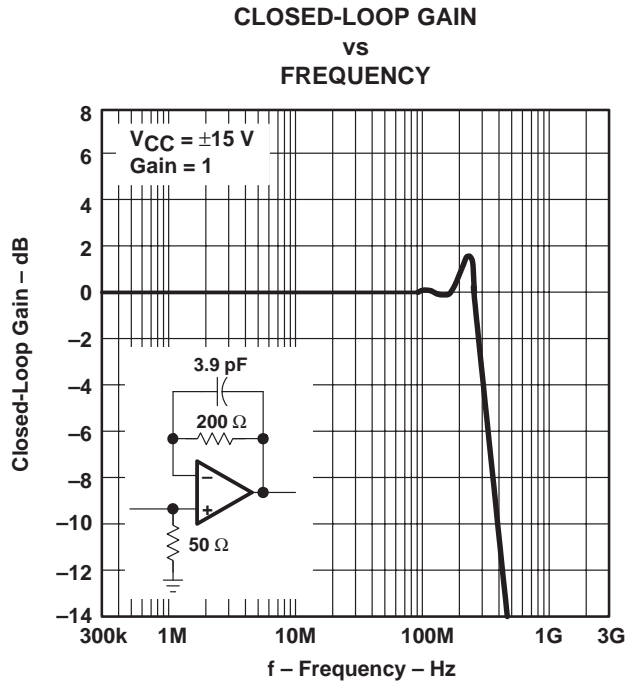

Figure 6

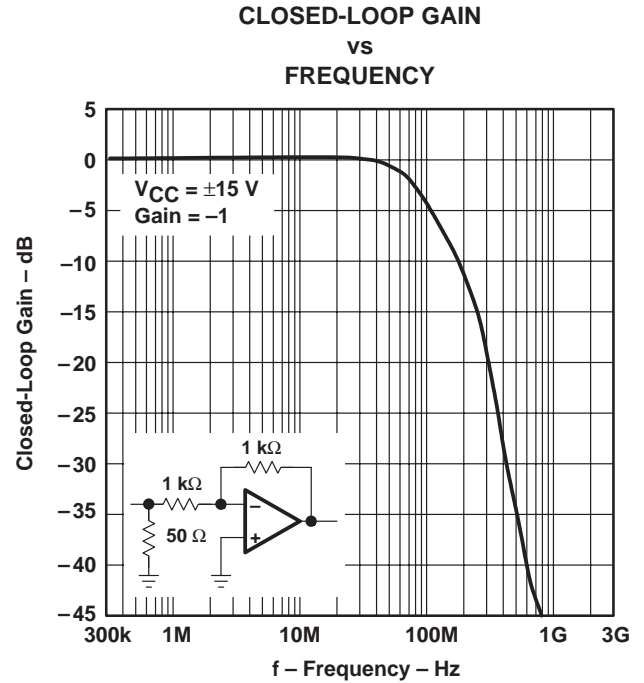

Figure 7

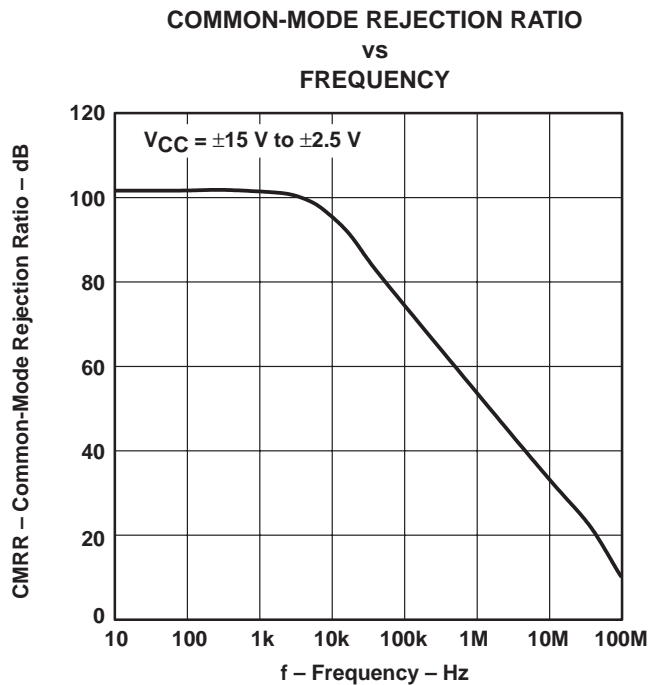

Figure 8

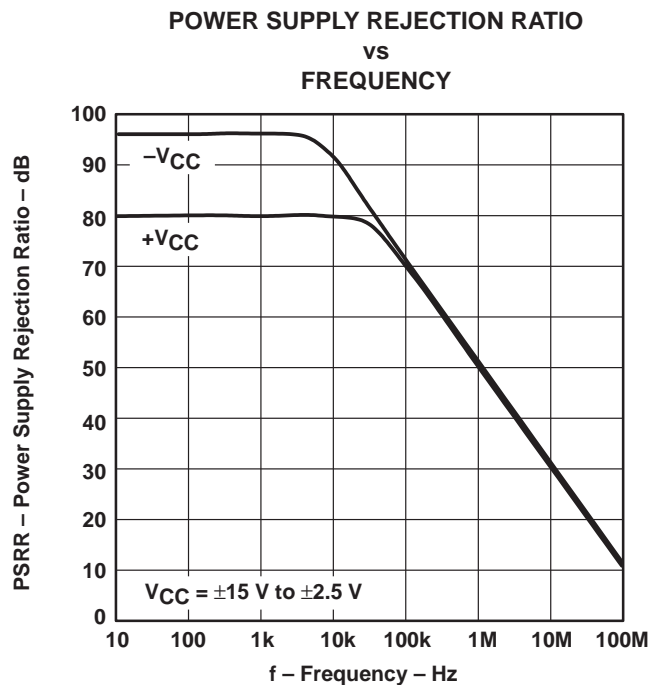

Figure 9

TYPICAL CHARACTERISTICS

POWER SUPPLY REJECTION RATIO
vs
FREE-AIR TEMPERATURE

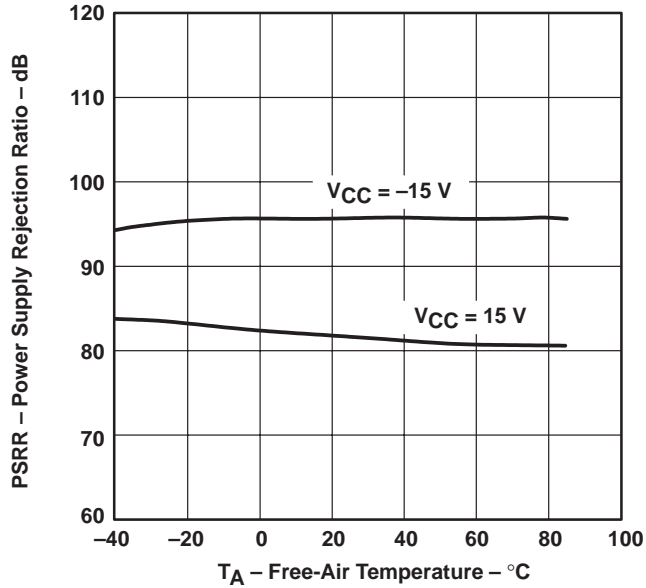

Figure 10

OUTPUT VOLTAGE SWING
vs
SUPPLY VOLTAGE

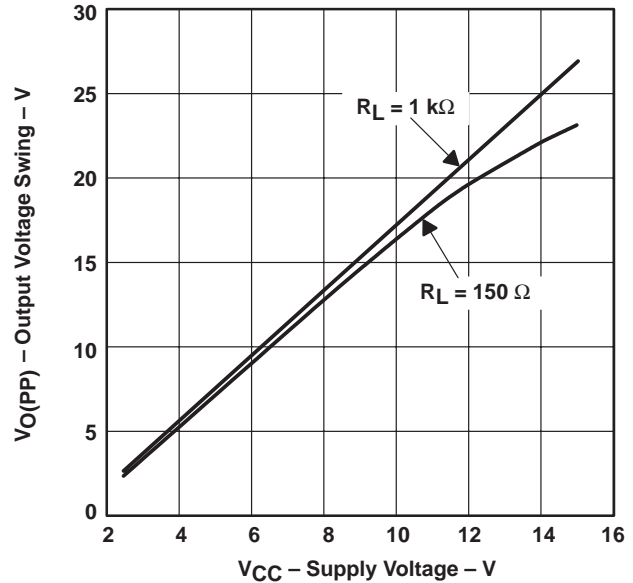

Figure 11

OUTPUT VOLTAGE SWING
vs
LOAD RESISTANCE

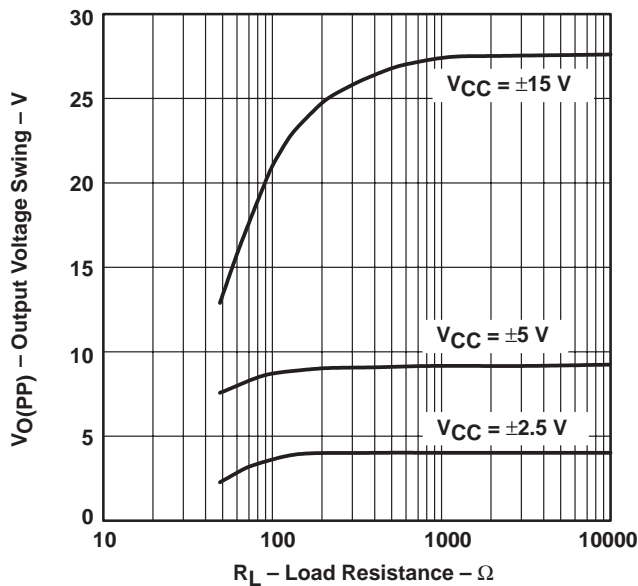

Figure 12

BANDWIDTH (-3 dB)
vs
FEEDBACK RESISTANCE

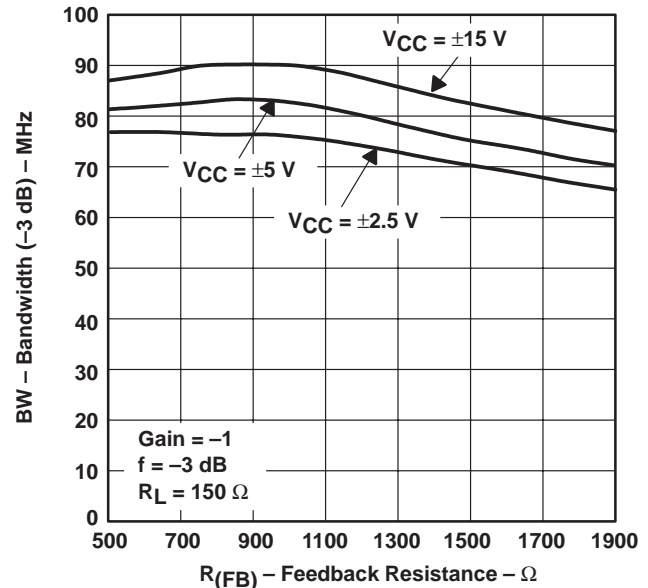

Figure 13

TYPICAL CHARACTERISTICS

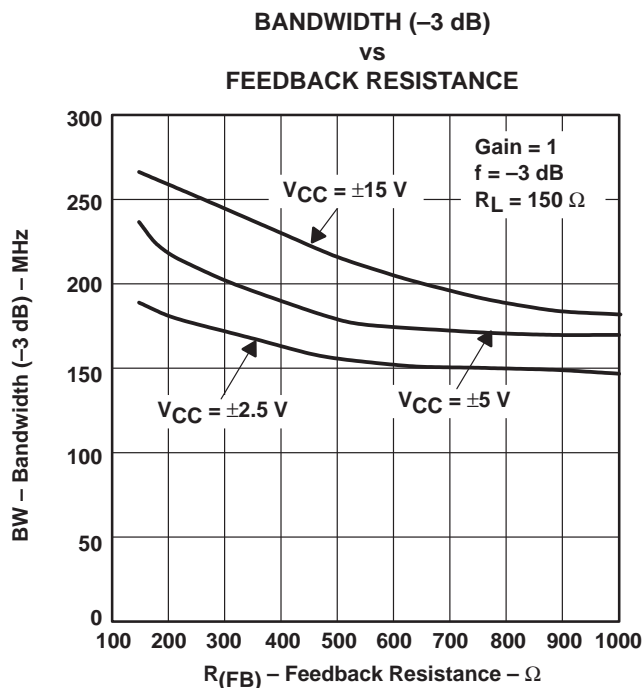

Figure 14

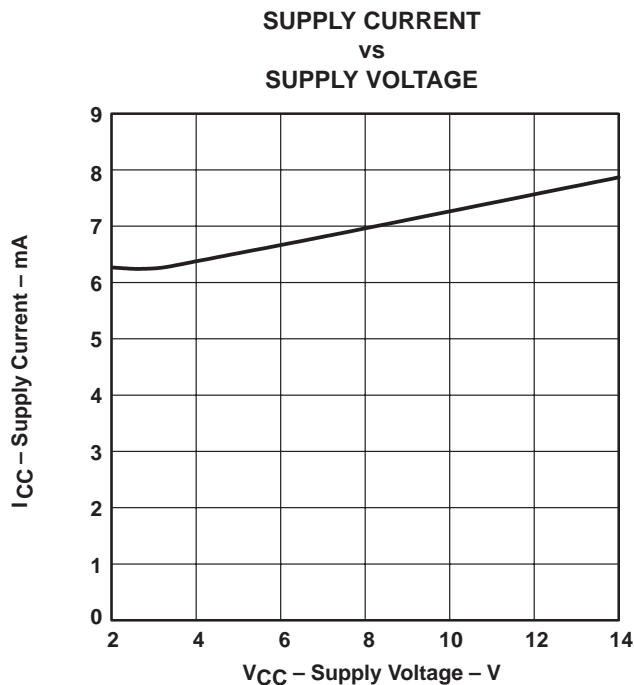

Figure 15

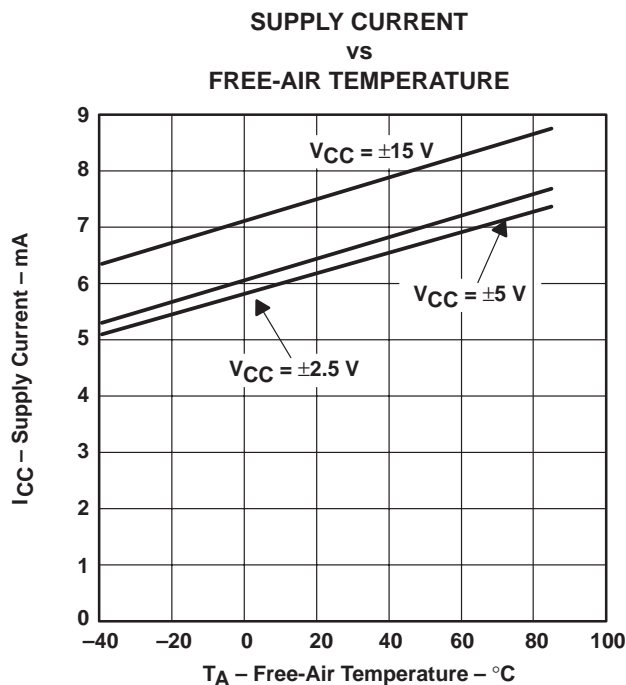

Figure 16

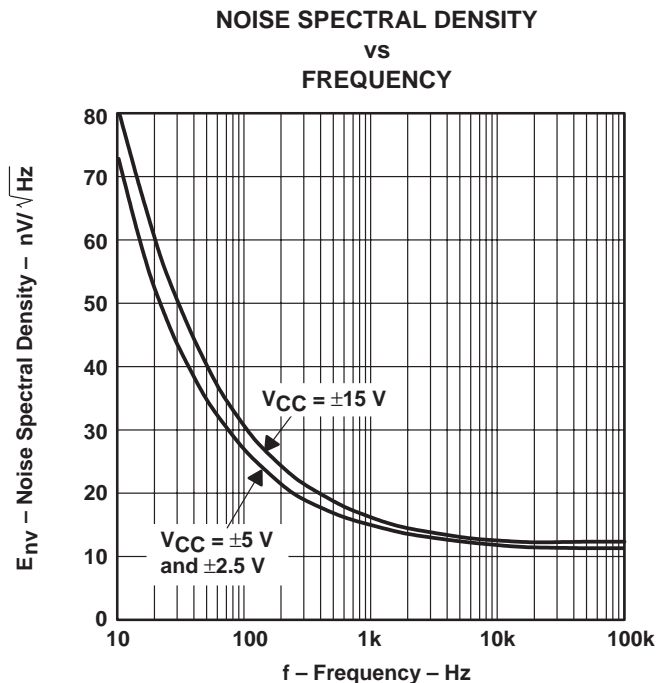

Figure 17

THS4001 270-MHz HIGH-SPEED AMPLIFIER

SLOS206A– DECEMBER 1997 – REVISED MARCH 1999

TYPICAL CHARACTERISTICS

TOTAL HARMONIC DISTORTION vs FREQUENCY

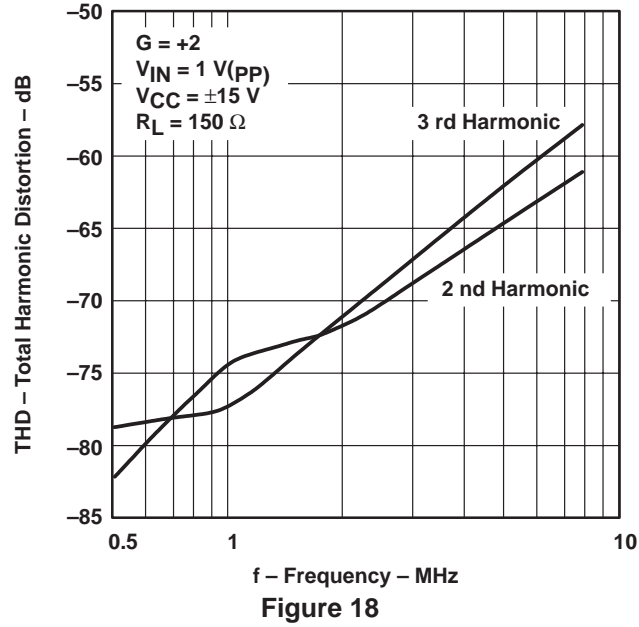

APPLICATION INFORMATION

theory of operation

The THS4001 is a high speed, operational amplifier configured in a voltage feedback architecture. It is built using a 30-V, dielectrically isolated, complementary bipolar process with NPN and PNP transistors possessing f_T s of several GHz. This results in an exceptionally high performance amplifier that has a wide bandwidth, high slew rate, fast settling time, and low distortion. A simplified schematic is shown in Figure 19.

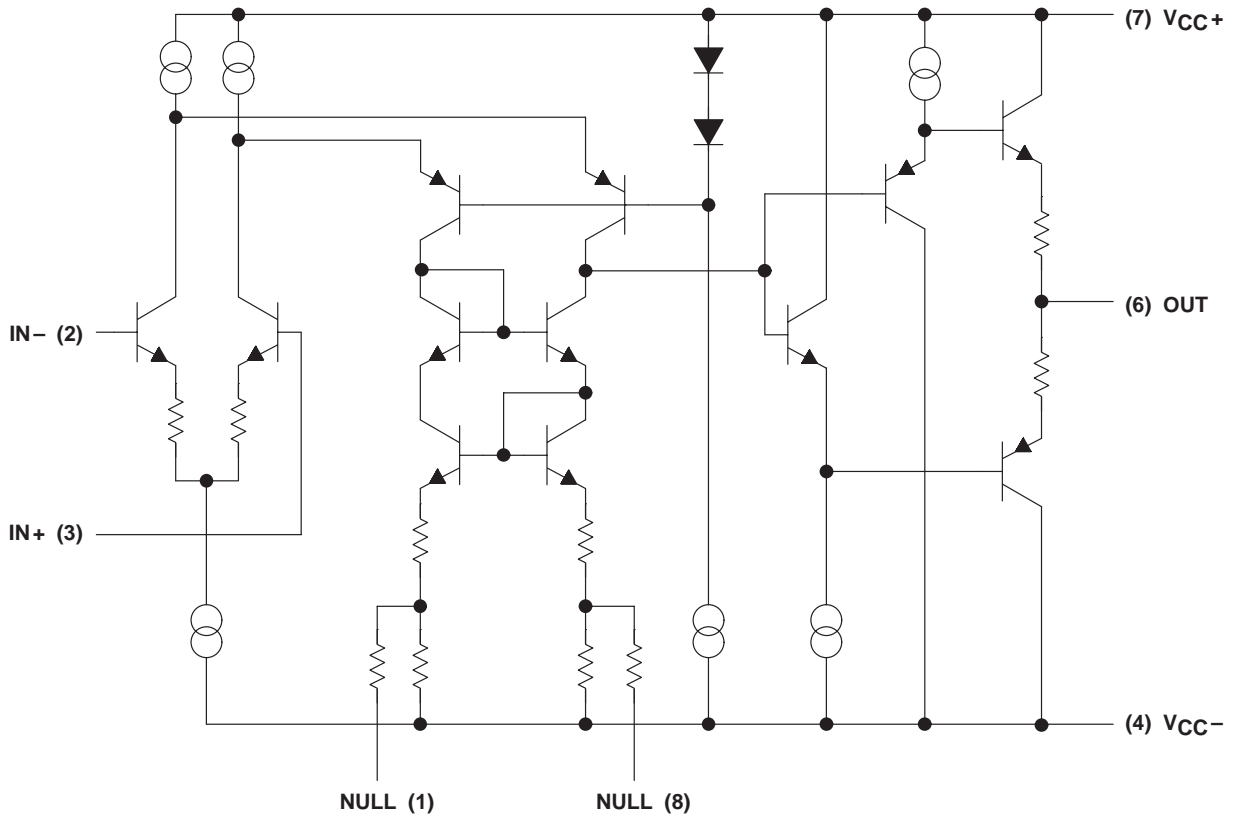

Figure 19. THS4001 Simplified Schematic

THS4001 270-MHz HIGH-SPEED AMPLIFIER

SLOS206A—DECEMBER 1997—REVISED MARCH 1999

APPLICATION INFORMATION

offset nulling

The THS4001 has very low input offset voltage for a high-speed amplifier. However, if additional correction is required, an offset nulling function has been provided. By placing a potentiometer between terminals 1 and 8 of the device and tying the wiper to the negative supply, the input offset can be adjusted. This is shown in Figure 20.

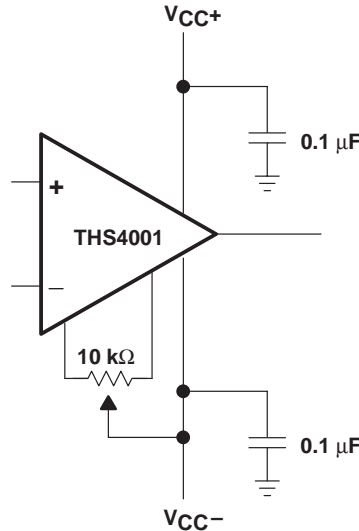

Figure 20. Offset Nulling Schematic

optimizing unity gain response

Internal frequency compensation of the THS4001 was selected to provide very wideband performance yet still maintain stability when operated in a noninverting unity gain configuration. When amplifiers are compensated in this manner there is usually peaking in the closed loop response and some ringing in the step response for very fast input edges, depending upon the application. This is because a minimum phase margin is maintained for the $G=+1$ configuration. For optimum settling time and minimum ringing, a feedback resistor of 200 Ω should be used as shown in Figure 21. Additional capacitance can also be used in parallel with the feedback resistance if even finer optimization is required.

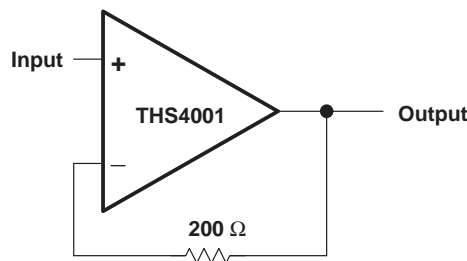

Figure 21. Noninverting, Unity Gain Schematic

APPLICATION INFORMATION

driving a capacitive load

Driving capacitive loads with high performance amplifiers is not a problem as long as certain precautions are taken. The first is to realize that the THS4001 has been internally compensated to maximize its bandwidth and slew rate performance. When the amplifier is compensated in this manner, capacitive loading directly on the output will decrease the device's phase margin leading to high frequency ringing or oscillations. Therefore, for capacitive loads of greater than 10 pF, it is recommended that a resistor be placed in series with the output of the amplifier, as shown in Figure 22. A minimum value of 20 Ω should work well for most applications. For example, in 75- Ω transmission systems, setting the series resistor value to 75 Ω both isolates any capacitance loading and provides the proper line impedance matching at the source end.

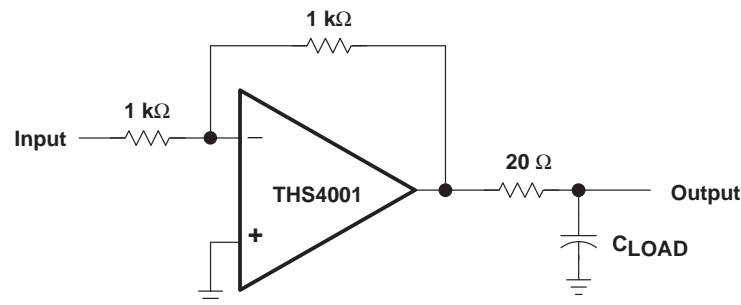

Figure 22. Driving a Capacitive Load

circuit layout considerations

In order to achieve the levels of high frequency performance of the THS4001, it is essential that proper printed-circuit board high frequency design techniques be followed. A general set of guidelines is given below. In addition, a THS4001 evaluation board is available to use as a guide for layout or for evaluating the device performance.

- Ground planes – It is highly recommended that a ground plane be used on the board to provide all components with a low inductive ground connection. However, in the areas of the amplifier inputs and output, the ground plane can be removed to minimize the stray capacitance.
- Proper power supply decoupling – Use a 6.8- μ F tantalum capacitor in parallel with a 0.1- μ F ceramic capacitor on each supply terminal. It may be possible to share the tantalum among several amplifiers depending on the application, but a 0.1- μ F ceramic capacitor should always be used on the supply terminal of every amplifier. In addition, the 0.1- μ F capacitor should be placed as close as possible to the supply terminal. As this distance increases, the inductance in the connecting trace makes the capacitor less effective. The designer should strive for distances of less than 0.1 inches between the device power terminals and the ceramic capacitors.
- Sockets – Sockets are not recommended for high speed op amps. The additional lead inductance in the socket pins will often lead to stability problems. Surface-mount packages soldered directly to the printed-circuit board is the best implementation.
- Short trace runs/compact part placements – Optimum high frequency performance is achieved when stray series inductance has been minimized. To realize this, the circuit layout should be made as compact as possible thereby minimizing the length of all trace runs. Particular attention should be paid to the inverting input of the amplifier. Its length should be kept as short as possible. This will help to minimize stray capacitance at the input of the amplifier.

THS4001 270-MHz HIGH-SPEED AMPLIFIER

SLOS206A–DECEMBER 1997 – REVISED MARCH 1999

APPLICATION INFORMATION

circuit layout considerations (continued)

- Surface-mount passive components – Using surface mount passive components is recommended for high frequency amplifier circuits for several reasons. First, because of the extremely low lead inductance of surface-mount components, the problem with stray series inductance is greatly reduced. Second, the small size of surface-mount components naturally leads to a more compact layout thereby minimizing both stray inductance and capacitance. If leaded components are used, it is recommended that the lead lengths be kept as short as possible.

evaluation board

An evaluation board is available for the THS4001 (literature number SLOP119). This board has been configured for very low parasitic capacitance in order to realize the full performance of the amplifier. A schematic of the evaluation board is shown in Figure 23. The circuitry has been designed so that the amplifier may be used in either an inverting or noninverting configuration. To order the evaluation board contact your local TI sales office or distributor. For more detailed information, refer to the *THS4001 EVM User's Manual* (literature number SLOU017).

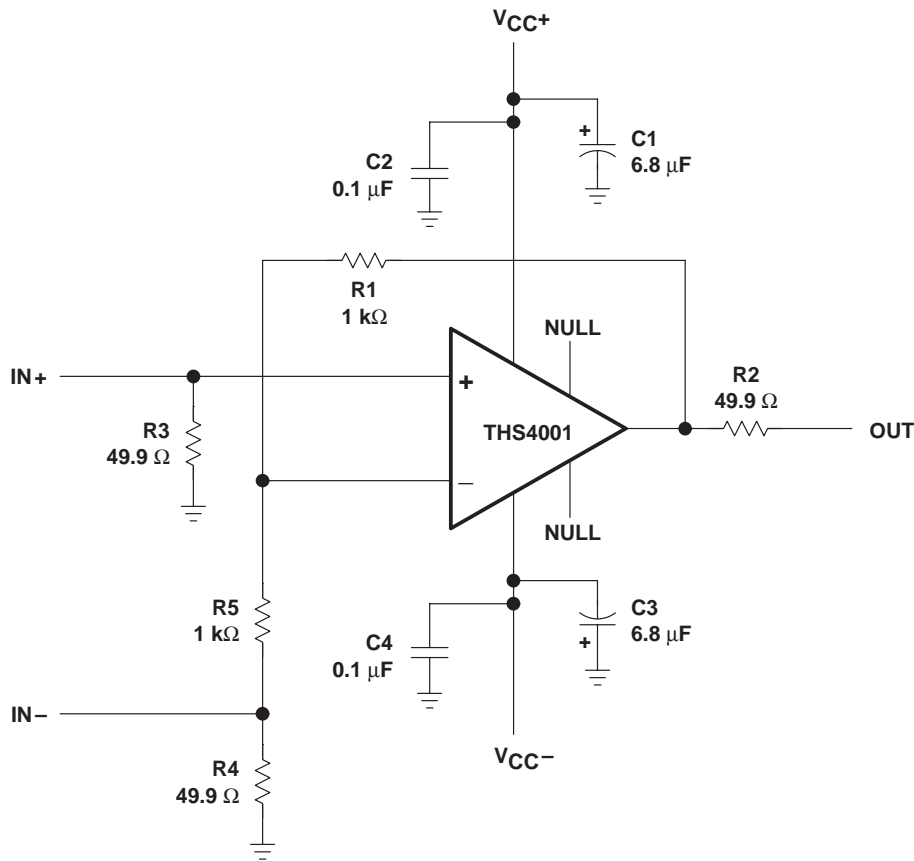

Figure 23.

MECHANICAL INFORMATION

D (R-PDSO-G**)

PLASTIC SMALL-OUTLINE PACKAGE

14 PIN SHOWN

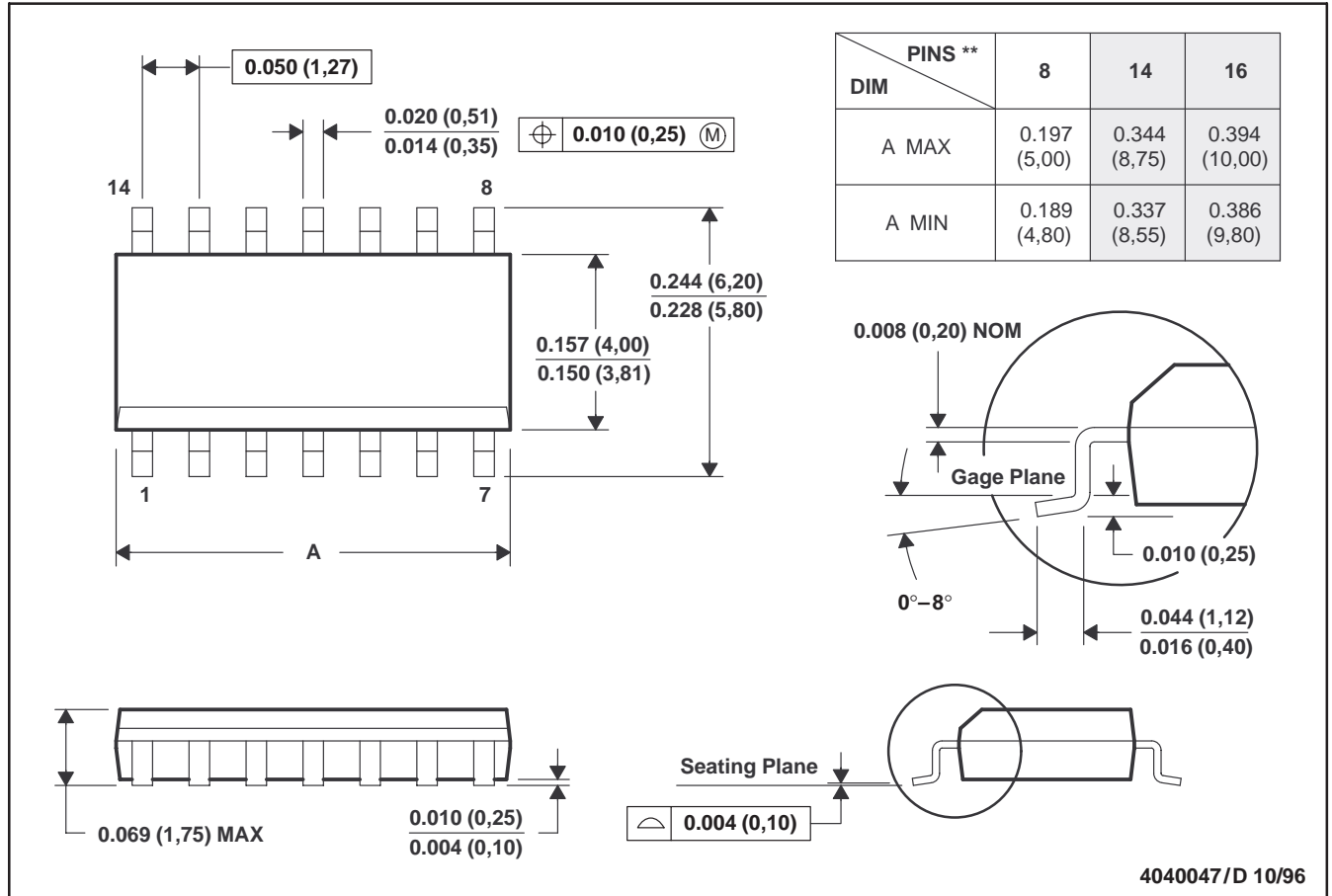

- NOTES: A. All linear dimensions are in inches (millimeters).
 B. This drawing is subject to change without notice.
 C. Body dimensions do not include mold flash or protrusion, not to exceed 0.006 (0,15).
 D. Falls within JEDEC MS-012

IMPORTANT NOTICE

Texas Instruments and its subsidiaries (TI) reserve the right to make changes to their products or to discontinue any product or service without notice, and advise customers to obtain the latest version of relevant information to verify, before placing orders, that information being relied on is current and complete. All products are sold subject to the terms and conditions of sale supplied at the time of order acknowledgement, including those pertaining to warranty, patent infringement, and limitation of liability.

TI warrants performance of its semiconductor products to the specifications applicable at the time of sale in accordance with TI's standard warranty. Testing and other quality control techniques are utilized to the extent TI deems necessary to support this warranty. Specific testing of all parameters of each device is not necessarily performed, except those mandated by government requirements.

CERTAIN APPLICATIONS USING SEMICONDUCTOR PRODUCTS MAY INVOLVE POTENTIAL RISKS OF DEATH, PERSONAL INJURY, OR SEVERE PROPERTY OR ENVIRONMENTAL DAMAGE ("CRITICAL APPLICATIONS"). TI SEMICONDUCTOR PRODUCTS ARE NOT DESIGNED, AUTHORIZED, OR WARRANTED TO BE SUITABLE FOR USE IN LIFE-SUPPORT DEVICES OR SYSTEMS OR OTHER CRITICAL APPLICATIONS. INCLUSION OF TI PRODUCTS IN SUCH APPLICATIONS IS UNDERSTOOD TO BE FULLY AT THE CUSTOMER'S RISK.

In order to minimize risks associated with the customer's applications, adequate design and operating safeguards must be provided by the customer to minimize inherent or procedural hazards.

TI assumes no liability for applications assistance or customer product design. TI does not warrant or represent that any license, either express or implied, is granted under any patent right, copyright, mask work right, or other intellectual property right of TI covering or relating to any combination, machine, or process in which such semiconductor products or services might be or are used. TI's publication of information regarding any third party's products or services does not constitute TI's approval, warranty or endorsement thereof.