

THS4061, THS4062 180-MHz HIGH-SPEED AMPLIFIERS

SLOS234D – DECEMBER 1998 – REVISED FEBRUARY 2000

- **High Speed**
 - 180 MHz Bandwidth ($G = 1$, -3 dB)
 - 400 V/ μ s Slew Rate
 - 40-ns Settling Time (0.1%)
- **High Output Drive, $I_O = 115$ mA (typ)**
- **Excellent Video Performance**
 - 75 MHz 0.1 dB Bandwidth ($G = 1$)
 - 0.02% Differential Gain
 - 0.02° Differential Phase
- **Very Low Distortion**
 - THD = -72 dBc at $f = 1$ MHz
- **Wide Range of Power Supplies**
 - $V_{CC} = \pm 5$ V to ± 15 V
- **Available in Standard SOIC, MSOP, PowerPAD™, JG, or FK Package**
- **Evaluation Module Available**

description

The THS4061 and THS4062 are general-purpose, single/dual, high-speed voltage feedback amplifiers ideal for a wide range of applications including video, communication, and imaging. The devices offer very good ac performance with 180-MHz bandwidth, 400-V/ μ s slew rate, and 40-ns settling time (0.1%). The THS4061/2 are stable at all gains for both inverting and noninverting configurations. These amplifiers have a high output drive capability of 115 mA and draw only 7.8 mA supply current per channel. Excellent professional video results can be obtained with the low differential gain/phase errors of 0.02%/0.02° and wide 0.1 db flatness to 75 MHz. For applications requiring low distortion, the THS4061/2 is ideally suited with total harmonic distortion of -72 dBc at $f = 1$ MHz.

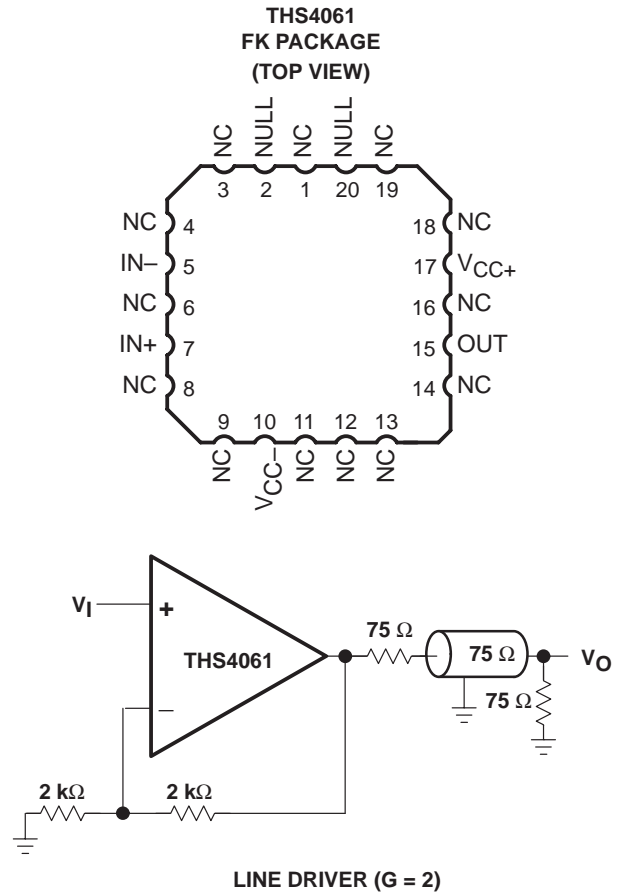
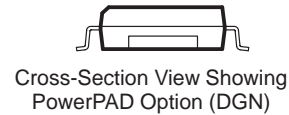
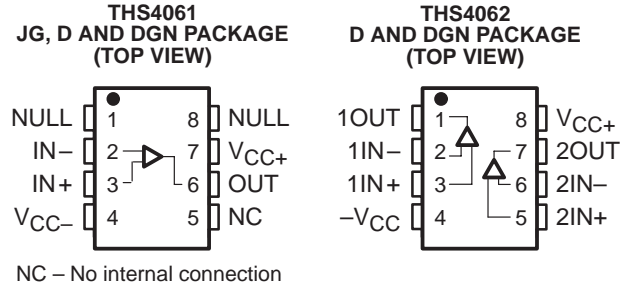

CAUTION: The THS4061 and THS4062 provide ESD protection circuitry. However, permanent damage can still occur if this device is subjected to high-energy electrostatic discharges. Proper ESD precautions are recommended to avoid any performance degradation or loss of functionality



Please be aware that an important notice concerning availability, standard warranty, and use in critical applications of Texas Instruments semiconductor products and disclaimers thereto appears at the end of this data sheet.

PowerPAD is a trademark of Texas Instruments Incorporated.

PRODUCTION DATA information is current as of publication date. Products conform to specifications per the terms of Texas Instruments standard warranty. Production processing does not necessarily include testing of all parameters.

**TEXAS
INSTRUMENTS**

POST OFFICE BOX 655303 • DALLAS, TEXAS 75265

Copyright © 2000, Texas Instruments Incorporated
On products compliant to MIL-PRF-38535, all parameters are tested unless otherwise noted. On all other products, production processing does not necessarily include testing of all parameters.

THS4061, THS4062 180-MHz HIGH-SPEED AMPLIFIERS

SLOS234D – DECEMBER 1998 – REVISED FEBRUARY 2000

RELATED DEVICES	
DEVICE	DESCRIPTION
THS4011/2	290-MHz Low Distortion High-Speed Amplifiers
THS4031/2	100-MHz Low Noise High Speed-Amplifiers
THS4061/2	180-MHz High-Speed Amplifiers

AVAILABLE OPTIONS

T _A	NUMBER OF CHANNELS	PACKAGED DEVICES				MSOP SYMBOL	EVALUATION MODULES
		PLASTIC SMALL OUTLINE† (D)	PLASTIC MSOP† (DGN)	CERAMIC DIP (JG)	CHIP CARRIER (FK)		
0°C to 70°C	1	THS4061CD	THS4061CDGN	—	—	TIABS	THS4061EVM
	2	THS4062CD	THS4062CDGN	—	—	TIABM	THS4062EVM
-40°C to 85°C	1	THS4061ID	THS4061IDGN	—	—	TIABT	—
	2	THS4062ID	THS4062IDGN	—	—	TIABN	—
-55°C to 125°C	1	—	—	THS4061MJG	THS4061MFK	—	—

† The D and DGN packages are available taped and reeled. Add an R suffix to the device type (i.e., THS4061CDGNR).

functional block diagram

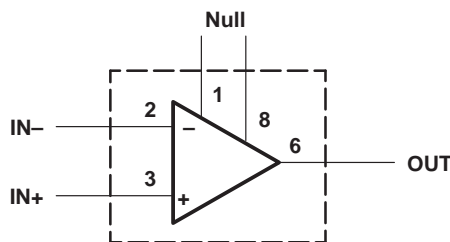

Figure 1. THS4061 – Single Channel

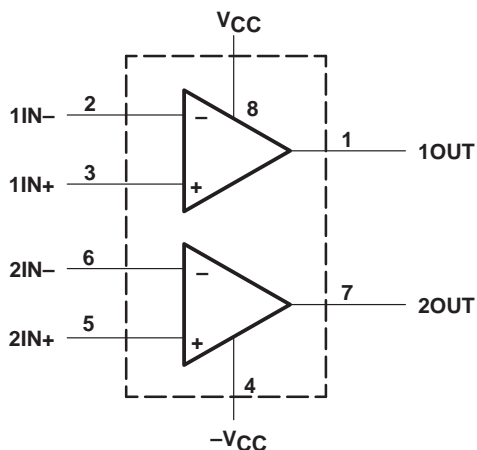

Figure 2. THS4062 – Dual Channel

absolute maximum ratings over operating free-air temperature (unless otherwise noted)†

Supply voltage, V_{CC+} to V_{CC-}	33 V
Input voltage, V_I	$\pm V_{CC}$
Output current, I_O	150 mA
Differential input voltage, V_{IO}	± 4 V
Continuous total power dissipation	See Dissipation Rating Table
Maximum junction temperature, T_J	150°C
Operating free-air temperature, T_A :	
C-suffix	0°C to 70°C
I-suffix	-40°C to 85°C
M-suffix	-55°C to 125°C
Storage temperature, T_{stg}	-65°C to 150°C
Lead temperature 1,6 mm (1/16 inch) from case for 10 seconds, D and DGN package	300°C
Lead temperature 1,6 mm (1/16 inch) from case for 60 seconds, JG package	300°C
Case temperature for 60 seconds, FK package	260°C

† Stresses beyond those listed under “absolute maximum ratings” may cause permanent damage to the device. These are stress ratings only and functional operation of the device at these or any other conditions beyond those indicated under “recommended operating conditions” is not implied. Exposure to absolute-maximum-rated conditions for extended periods may affect device reliability.

DISSIPATION RATING TABLE

PACKAGE	$T_A \leq 25^\circ\text{C}$ POWER RATING	DERATING FACTOR ABOVE $T_A = 25^\circ\text{C}$	$T_A = 70^\circ\text{C}$ POWER RATING	$T_A = 85^\circ\text{C}$ POWER RATING	$T_A = 125^\circ\text{C}$ POWER RATING
D	740 mW	6 mW/°C	475 mW	385 mW	—
DGN‡	2.14 W	17.1 mW/°C	1.37 W	1.11 W	—
JG	1057 mW	8.4 mW/°C	627 mW	546 mW	210 mW
FK	1375 mW	11 mW/°C	880 mW	715 mW	275 mW

‡ The DGN package incorporates a PowerPAD on the underside of the device. This acts as a heatsink and must be connected to a thermal dissipation plane for proper power dissipation. Failure to do so can result in exceeding the maximum specified junction temperature, which could permanently damage the device.

recommended operating conditions

		MIN	NOM	MAX	UNIT
Supply voltage, V_{CC+} and V_{CC-}	Dual supply	± 4.5		± 16	V
	Single supply	9		32	
Operating free-air temperature, T_A	C-suffix	0		70	°C
	I-suffix	-40		85	
	M-suffix	-55		125	

THS4061, THS4062 180-MHz HIGH-SPEED AMPLIFIERS

SLOS234D – DECEMBER 1998 – REVISED FEBRUARY 2000

electrical characteristics at $T_A = 25^\circ\text{C}$, $V_{CC} = \pm 15\text{ V}$, $R_L = 150\ \Omega$ (unless otherwise noted)

dynamic performance

PARAMETER		TEST CONDITION [†]		THS4061C/I, THS4062C/I			UNIT	
				MIN	TYP	MAX		
BW	Dynamic performance small-signal bandwidth (–3 dB)	$V_{CC} = \pm 5\text{ V}$	Gain = 1	180			MHz	
		$V_{CC} = \pm 15\text{ V}$	Gain = –1	50			MHz	
	Bandwidth for 0.1 dB flatness	$V_{CC} = \pm 5\text{ V}$	Gain = 1	75			MHz	
		$V_{CC} = \pm 15\text{ V}$		20				
SR	Slew rate	$V_{CC} = \pm 15\text{ V}$	Gain = –1	400			V/ μs	
		$V_{CC} = \pm 5\text{ V}$		350				
t_s	Settling time to 0.1%	$V_{CC} = \pm 15\text{ V}$, 5-V step (0 V to 5 V)		Gain = –1	40			ns
		$V_{CC} = \pm 5\text{ V}$, $V_O = -2.5\text{ V}$ to 2.5 V			40			
	Settling time to 0.01%	$V_{CC} = \pm 15\text{ V}$, 5-V step (0 V to 5 V)		Gain = –1	140			ns
		$V_{CC} = \pm 5\text{ V}$, $V_O = -2.5\text{ V}$ to 2.5 V			150			

[†] Full range = 0°C to 70°C for C suffix and -40°C to 85°C for I suffix

noise/distortion performance

PARAMETER		TEST CONDITION [†]		THS4061C/I, THS4062C/I			UNIT
				MIN	TYP	MAX	
THD	Total harmonic distortion	$f = 1\text{ MHz}$		–72			dBc
V_n	Input voltage noise	$f = 10\text{ kHz}$, $V_{CC} = \pm 5\text{ V}$ or $\pm 15\text{ V}$		14.5			$\text{nV}/\sqrt{\text{Hz}}$
I_n	Input current noise	$f = 10\text{ kHz}$, $V_{CC} = \pm 5\text{ V}$ or $\pm 15\text{ V}$		1.6			$\text{pA}/\sqrt{\text{Hz}}$
	Differential gain error	Gain = 2, NTSC, 40 IRE modulation	$V_{CC} = \pm 15\text{ V}$	0.02%			
			$V_{CC} = \pm 5\text{ V}$	0.02%			
	Differential phase error	Gain = 2, NTSC, 40 IRE modulation	$V_{CC} = \pm 15\text{ V}$	0.02°			
			$V_{CC} = \pm 5\text{ V}$	0.06°			
	Channel-to-channel crosstalk (THS4062 only)	$V_{CC} = \pm 5\text{ V}$ or $\pm 15\text{ V}$, $f = 1\text{ MHz}$		65			dB

[†] Full range = 0°C to 70°C for C suffix and -40°C to 85°C for I suffix

dc performance

PARAMETER		TEST CONDITION [†]		THS4061C/I, THS4062C/I			UNIT
				MIN	TYP	MAX	
Open loop gain		$V_{CC} = \pm 15\text{ V}$, $V_O = \pm 10\text{ V}$, $R_L = 1\text{ k}\Omega$	$T_A = 25^\circ\text{C}$	5	15	V/mV	
			$T_A = \text{full range}$	4			
		$V_{CC} = \pm 5\text{ V}$, $V_O = \pm 2.5\text{ V}$, $R_L = 1\text{ k}\Omega$	$T_A = 25^\circ\text{C}$	2.5	8	V/mV	
			$T_A = \text{full range}$	2			
V_{OS}	Input offset voltage	$V_{CC} = \pm 5\text{ V}$ or $\pm 15\text{ V}$	$T_A = \text{full range}$	2.5	8	mV	
	Offset drift	$V_{CC} = \pm 5\text{ V}$ or $\pm 15\text{ V}$		15		$\mu\text{V}/^\circ\text{C}$	
I_{IB}	Input bias current	$V_{CC} = \pm 5\text{ V}$ or $\pm 15\text{ V}$	$T_A = \text{full range}$	3	6	μA	
I_{OS}	Input offset current	$V_{CC} = \pm 5\text{ V}$ or $\pm 15\text{ V}$	$T_A = \text{full range}$	75	250	nA	
	Offset current drift	$T_A = \text{full range}$		0.3		$\text{nA}/^\circ\text{C}$	

[†] Full range = 0°C to 70°C for C suffix and -40°C to 85°C for I suffix



electrical characteristics at $T_A = 25^\circ\text{C}$, $V_{CC} = \pm 15\text{ V}$, $R_L = 150\ \Omega$ (unless otherwise noted) (continued)

input characteristics

PARAMETER	TEST CONDITION [†]	THS4061C/I, THS4062C/I			UNIT
		MIN	TYP	MAX	
V_{ICR} Common-mode input voltage range	$V_{CC} = \pm 15\text{ V}$	± 13.8	± 14.1		V
	$V_{CC} = \pm 5\text{ V}$	± 3.8	± 4.3		
CMRR Common mode rejection ratio	$V_{CC} = \pm 15\text{ V}$, $V_{ICR} = \pm 12\text{ V}$	70	110	$T_A = \text{full range}$	dB
	$V_{CC} = \pm 5\text{ V}$, $V_{ICR} = \pm 2.5\text{ V}$	70	95		
R_i Input resistance			1		M Ω
C_i Input capacitance			2		pF

[†] Full range = 0°C to 70°C for C suffix and -40°C to 85°C for I suffix

output characteristics

PARAMETER	TEST CONDITION [†]	THS4061C/I, THS4062C/I			UNIT
		MIN	TYP	MAX	
V_O Output voltage swing	$V_{CC} = \pm 15\text{ V}$	$R_L = 250\ \Omega$	± 11.5	± 12.5	V
	$V_{CC} = \pm 5\text{ V}$	$R_L = 150\ \Omega$	± 3.2	± 3.5	
	$V_{CC} = \pm 15\text{ V}$	$R_L = 1\text{ k}\Omega$	± 13	± 13.5	V
	$V_{CC} = \pm 5\text{ V}$		± 3.5	± 3.7	
I_O Output current	$V_{CC} = \pm 15\text{ V}$	$R_L = 20\ \Omega$	80	115	mA
	$V_{CC} = \pm 5\text{ V}$		50	75	
I_{SC} Short-circuit current	$V_{CC} = \pm 15\text{ V}$		150		mA
R_O Output resistance	Open loop		12		Ω

[†] Full range = 0°C to 70°C for C suffix and -40°C to 85°C for I suffix

power supply

PARAMETER	TEST CONDITION [†]	THS4061C/I, THS4062C/I			UNIT
		MIN	TYP	MAX	
V_{CC} Supply voltage operating range	Dual supply	± 4.5		± 16.5	V
	Single supply	9		33	
I_{CC} Quiescent current (per amplifier)	$V_{CC} = \pm 15\text{ V}$	$T_A = \text{full range}$	7.8	10.5	mA
	$V_{CC} = \pm 5\text{ V}$		7.3	10	
PSRR Power supply rejection ratio	$V_{CC} = \pm 5\text{ V}$ or $\pm 15\text{ V}$	$T_A = 25^\circ\text{C}$	70	78	dB
		$T_A = \text{full range}$	68		

[†] Full range = 0°C to 70°C for C suffix and -40°C to 85°C for I suffix

THS4061, THS4062 180-MHz HIGH-SPEED AMPLIFIERS

SLOS234D – DECEMBER 1998 – REVISED FEBRUARY 2000

electrical characteristics at $T_A = 25^\circ\text{C}$, $V_{CC} = \pm 15\text{ V}$, $R_L = 150\ \Omega$ (unless otherwise noted)

dynamic performance

PARAMETER		TEST CONDITIONST		THS4061M			UNIT
				MIN	TYP	MAX	
BW	Unity-gain bandwidth	Closed loop,	$R_L = 1\ \text{k}\Omega$	$V_{CC} = \pm 15\text{ V}$	*140	180	MHz
	Dynamic performance small-signal bandwidth (–3 dB)			Gain = 1	180		MHz
		$V_{CC} = \pm 15\text{ V}$			180		
		$V_{CC} = \pm 15\text{ V}$		Gain = –1	50		MHz
		$V_{CC} = \pm 5\text{ V}$			50		
Bandwidth for 0.1 dB flatness	$V_{CC} = \pm 15\text{ V}$		Gain = 1	75		MHz	
	$V_{CC} = \pm 5\text{ V}$			20			
SR	Slew rate	$V_{CC} = \pm 15\text{ V}$ $R_L = 1\ \text{k}\Omega$		*400	500	V/ μs	
t_s	Settling time to 0.1%	$V_{CC} = \pm 15\text{ V}$, 5-V step (0 V to 5 V)		Gain = –1	40		ns
		$V_{CC} = \pm 5\text{ V}$, $V_O = -2.5\text{ V}$ to 2.5 V			40		
	Settling time to 0.01%	$V_{CC} = \pm 15\text{ V}$, 5-V step (0 V to 5 V)		Gain = –1	140		ns
		$V_{CC} = \pm 5\text{ V}$, $V_O = -2.5\text{ V}$ to 2.5 V			150		

† Full range = -55°C to 125°C for M suffix

*This parameter is not tested.

noise/distortion performance

PARAMETER		TEST CONDITIONST		THS4061M			UNIT
				MIN	TYP	MAX	
THD	Total harmonic distortion	$f = 1\ \text{MHz}$		–72			dBc
V_n	Input voltage noise	$f = 10\ \text{kHz}$, $V_{CC} = \pm 5\text{ V}$ or $\pm 15\text{ V}$		14.5			$\text{nV}/\sqrt{\text{Hz}}$
I_n	Input current noise	$f = 10\ \text{kHz}$, $V_{CC} = \pm 5\text{ V}$ or $\pm 15\text{ V}$		1.6			$\text{pA}/\sqrt{\text{Hz}}$
	Differential gain error	Gain = 2,	NTSC, 40 IRE Modulation	$V_{CC} = \pm 15\text{ V}$	0.02		%
				$V_{CC} = \pm 5\text{ V}$	0.02		
	Differential phase error	Gain = 2,	NTSC, 40 IRE Modulation	$V_{CC} = \pm 15\text{ V}$	0.02°		
				$V_{CC} = \pm 5\text{ V}$	0.06°		

† Full range = -55°C to 125°C for M suffix

dc performance

PARAMETER		TEST CONDITIONST		THS4061M			UNIT
				MIN	TYP	MAX	
Open loop gain		$V_{CC} = \pm 15\text{ V}$, $V_O = \pm 10\text{ V}$, $R_L = 1\ \text{k}\Omega$		$T_A = \text{full range}$	5	9	V/mV
		$V_{CC} = \pm 5\text{ V}$, $V_O = \pm 2.5\text{ V}$, $R_L = 1\ \text{k}\Omega$			2.5	6	
V_{IO}	Input offset voltage	$V_{CC} = \pm 5\text{ V}$ or $\pm 15\text{ V}$ $R_L = 1\ \text{k}\Omega$		$T_A = 25^\circ\text{C}$	2.5	8	mV
	Offset drift	$V_{CC} = \pm 5\text{ V}$ or $\pm 15\text{ V}$ $R_L = 1\ \text{k}\Omega$		$T_A = \text{full range}$	9		mV
I_{IB}	Input bias current	$V_{CC} = \pm 5\text{ V}$ or $\pm 15\text{ V}$ $R_L = 1\ \text{k}\Omega$		$T_A = \text{full range}$	3	6	μA
I_{IO}	Input offset current	$V_{CC} = \pm 5\text{ V}$ or $\pm 15\text{ V}$ $R_L = 1\ \text{k}\Omega$		$T_A = \text{full range}$	75	250	nA
	Offset current drift	$V_{CC} = \pm 5\text{ V}$ or $\pm 15\text{ V}$ $R_L = 1\ \text{k}\Omega$		$T_A = \text{full range}$	0.3		$\text{nA}/^\circ\text{C}$

† Full range = -55°C to 125°C for M suffix



electrical characteristics at T_A = full range, $V_{CC} = \pm 15$ V, $R_L = 1$ k Ω (unless otherwise noted)
(continued)

input characteristics

PARAMETER	TEST CONDITIONST	THS4061M			UNIT
		MIN	TYP	MAX	
V_{ICR} Common-mode input voltage range	$V_{CC} = \pm 15$ V	± 13.8	± 14.1		V
	$V_{CC} = \pm 5$ V	± 3.8	± 4.3		
CMRR Common mode rejection ratio	$V_{CC} = \pm 15$ V, $V_{ICR} = \pm 12$ V	70	86		dB
	$V_{CC} = \pm 5$ V, $V_{ICR} = \pm 2.5$ V	80	90		
R_i Input resistance			1		M Ω
C_i Input capacitance			2		pF

† Full range = -55°C to 125°C for M suffix

output characteristics

PARAMETER	TEST CONDITIONST		THS4061M			UNIT
			MIN	TYP	MAX	
V_O Output voltage swing	$V_{CC} = \pm 15$ V	$R_L = 250$ Ω	± 12	± 13.1		V
	$V_{CC} = \pm 5$ V	$R_L = 150$ Ω	± 3.2	± 3.5		
	$V_{CC} = \pm 15$ V	$R_L = 1$ k Ω	± 13	± 13.5		V
	$V_{CC} = \pm 5$ V		± 3.5	± 3.7		
I_O Output current	$V_{CC} = \pm 15$ V	$R_L = 20$ Ω	70	115		mA
	$V_{CC} = \pm 5$ V		50	75		
I_{SC} Short-circuit current	$V_{CC} = \pm 15$ V	$T_A = 25^\circ\text{C}$		150		mA
R_O Output resistance	Open loop			12		Ω

† Full range = -55°C to 125°C for M suffix

power supply

PARAMETER	TEST CONDITIONST		THS4061M			UNIT
			MIN	TYP	MAX	
V_{CC} Supply voltage operating range	Dual supply		± 4.5		± 16.5	V
	Single supply		9		33	
I_{CC} Quiescent current	$V_{CC} = \pm 15$ V	$T_A = 25^\circ\text{C}$		7.8	9	mA
	$V_{CC} = \pm 5$ V			7.3	8.5	
	$V_{CC} = \pm 15$ V	$T_A = \text{full range}$			11	
	$V_{CC} = \pm 5$ V				10.5	
PSRR Power supply rejection ratio	$V_{CC} = \pm 5$ V or ± 15 V		$T_A = 25^\circ\text{C}$	76	80	dB
			$T_A = \text{full range}$	74	78	

† Full range = -55°C to 125°C for M suffix

THS4061, THS4062 180-MHz HIGH-SPEED AMPLIFIERS

SLOS234D – DECEMBER 1998 – REVISED FEBRUARY 2000

TYPICAL CHARACTERISTICS

			FIGURE
I_{IB}	Input bias current	vs Free-air temperature	3
V_{IO}	Input offset voltage	vs Free-air temperature	4
	Open-loop gain	vs Frequency	5
	Phase	vs Frequency	5
	Differential gain	vs Number of loads	6, 8
	Differential phase	vs Number of loads	7, 9
	Closed-loop gain	vs Frequency	10, 11
	Output Amplitude	vs Frequency	12, 13
CMRR	Common-mode rejection ratio	vs Frequency	14
PSRR	Power-supply rejection ratio	vs Frequency	15
		vs Free-air temperature	16
$V_{O(PP)}$	Output voltage swing	vs Supply voltage	17
I_{CC}	Supply current	vs Free-air temperature	18
E_{nv}	Noise spectral density	vs Frequency	19
THD	Total harmonic distortion	vs Frequency	20, 21



TYPICAL CHARACTERISTICS

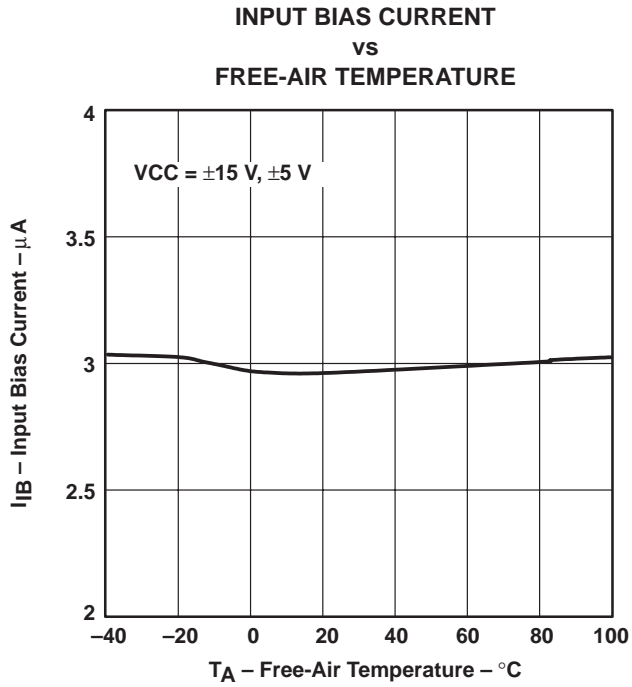

Figure 3

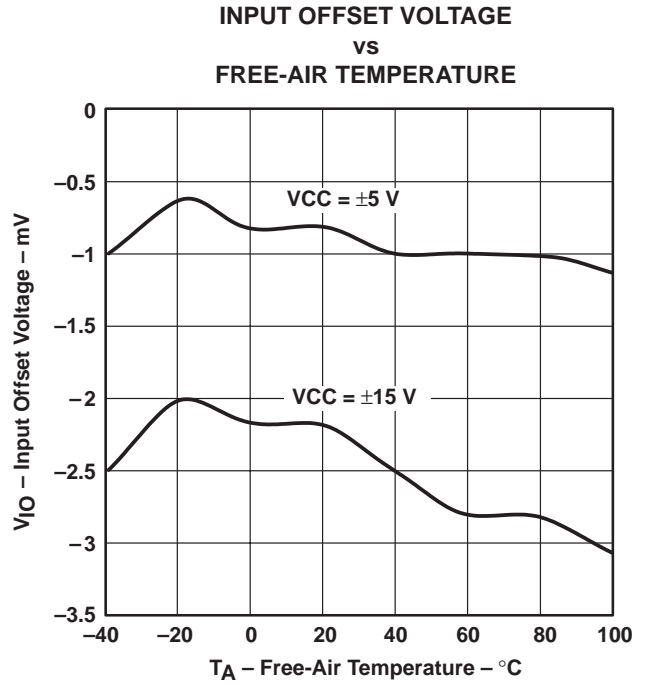

Figure 4

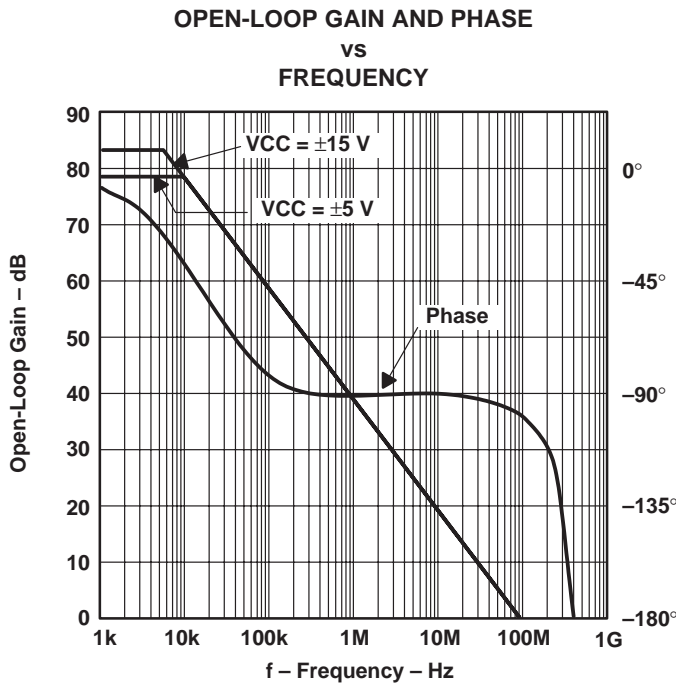

Figure 5

TYPICAL CHARACTERISTICS

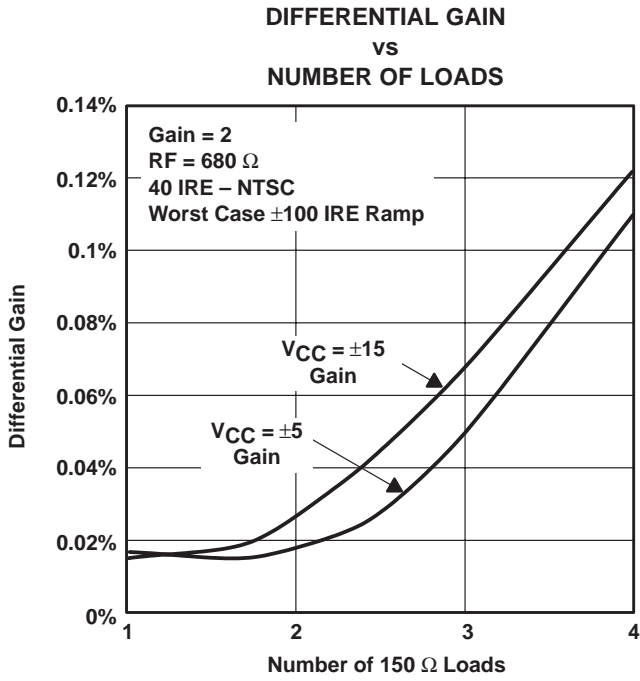

Figure 6

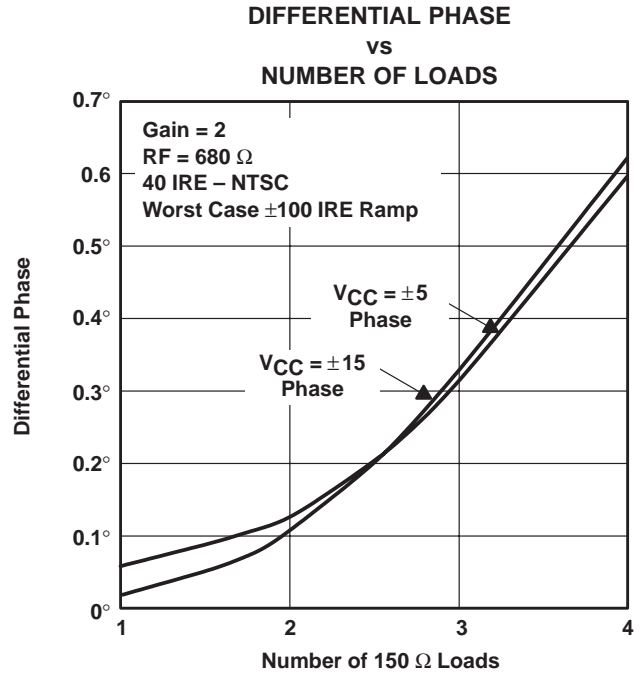

Figure 7

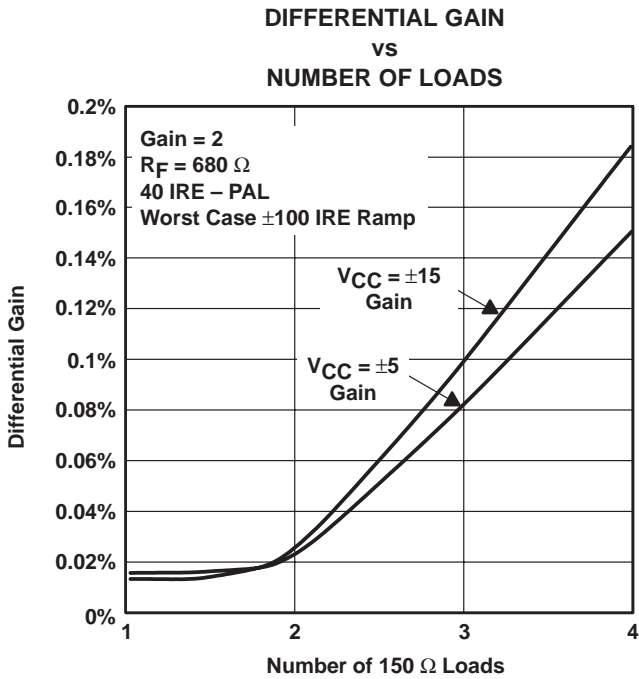

Figure 8

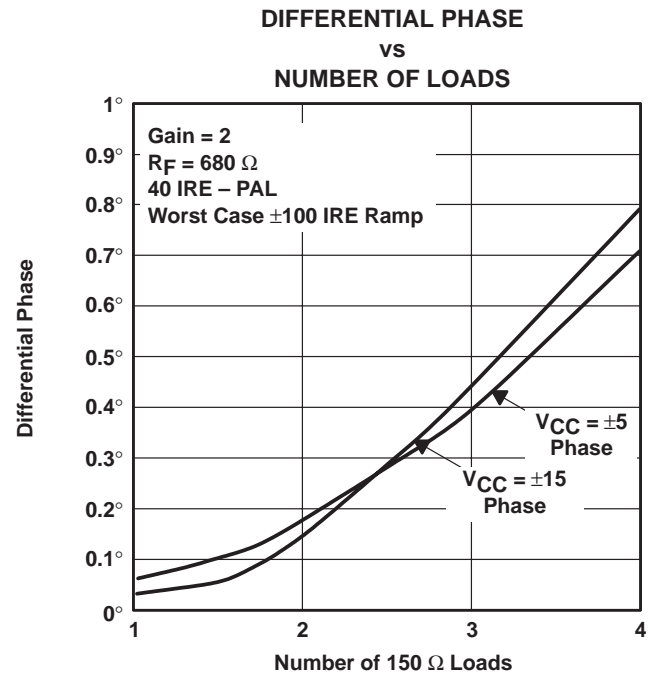

Figure 9

TYPICAL CHARACTERISTICS

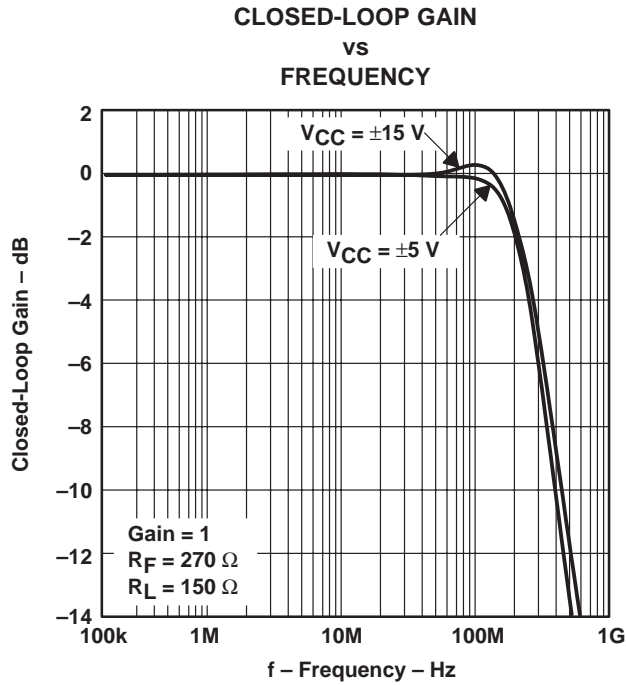

Figure 10

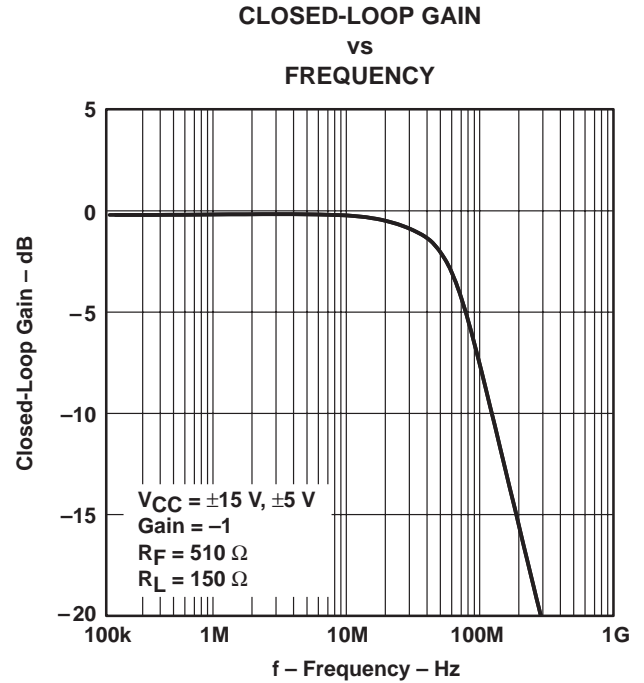

Figure 11

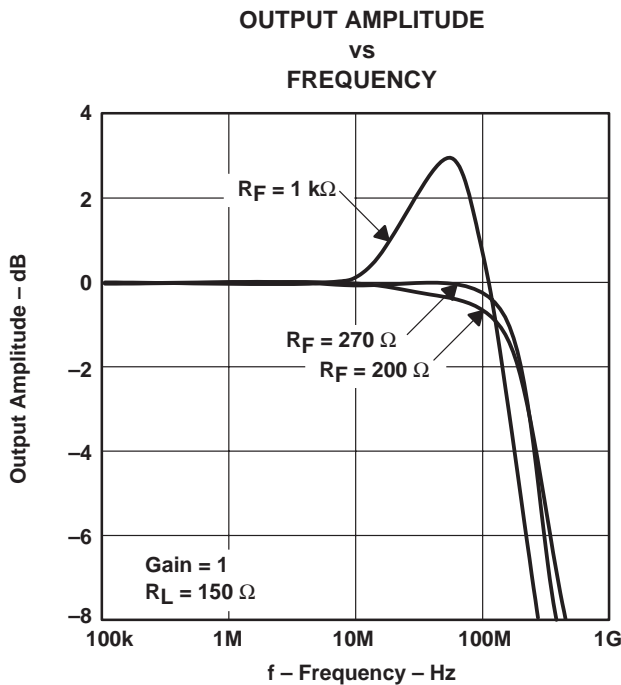

Figure 12

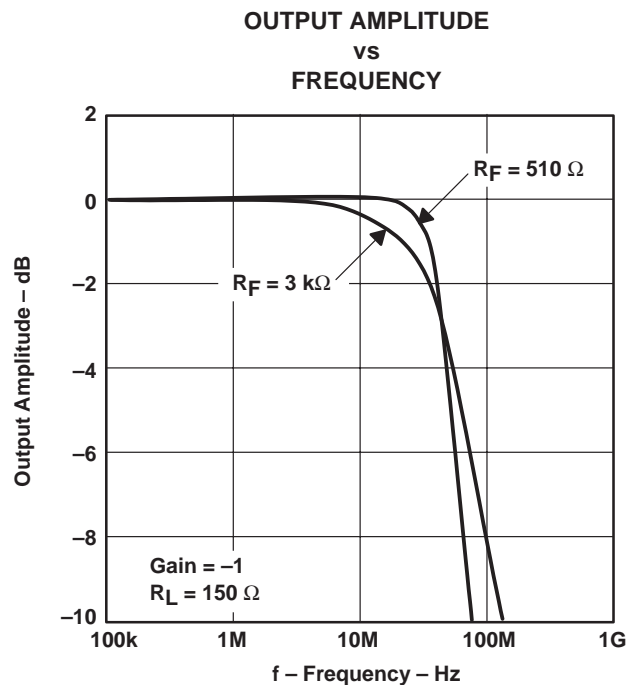

Figure 13

TYPICAL CHARACTERISTICS

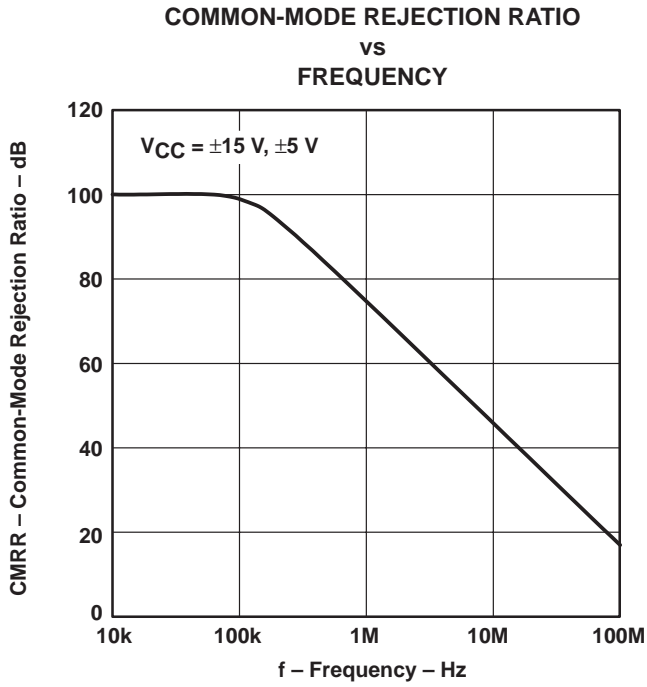

Figure 14

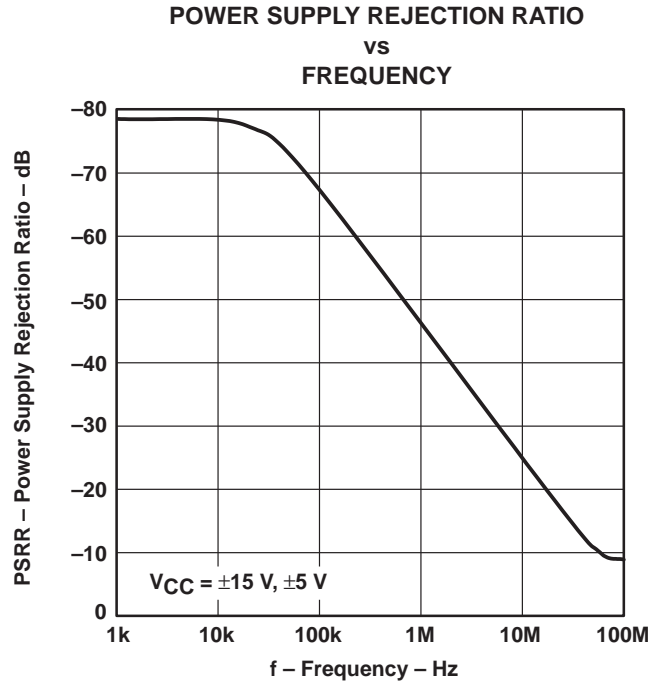

Figure 15

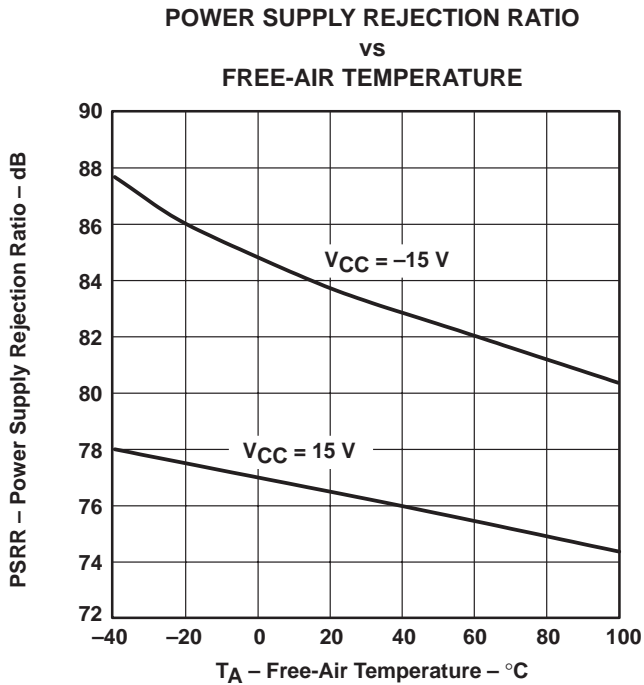

Figure 16

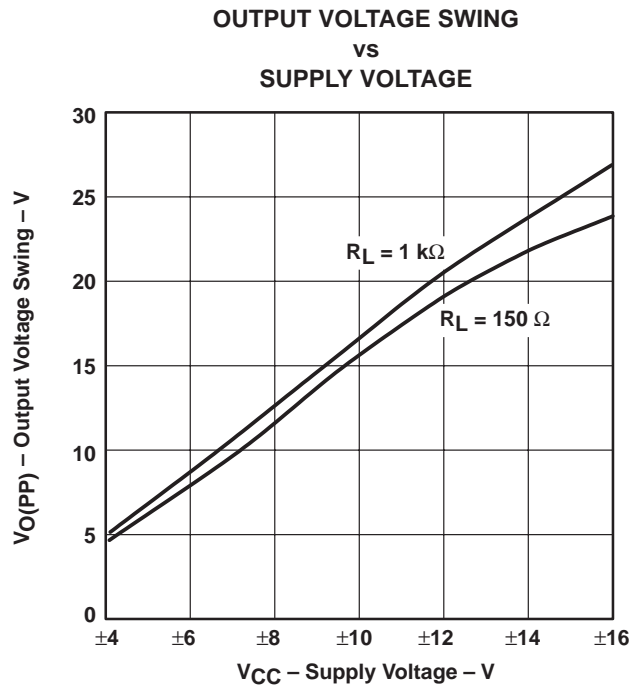

Figure 17

TYPICAL CHARACTERISTICS

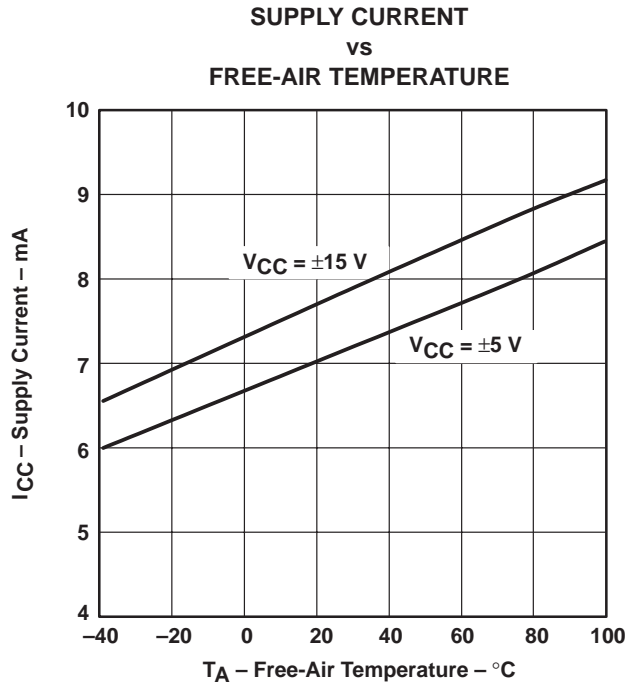

Figure 18

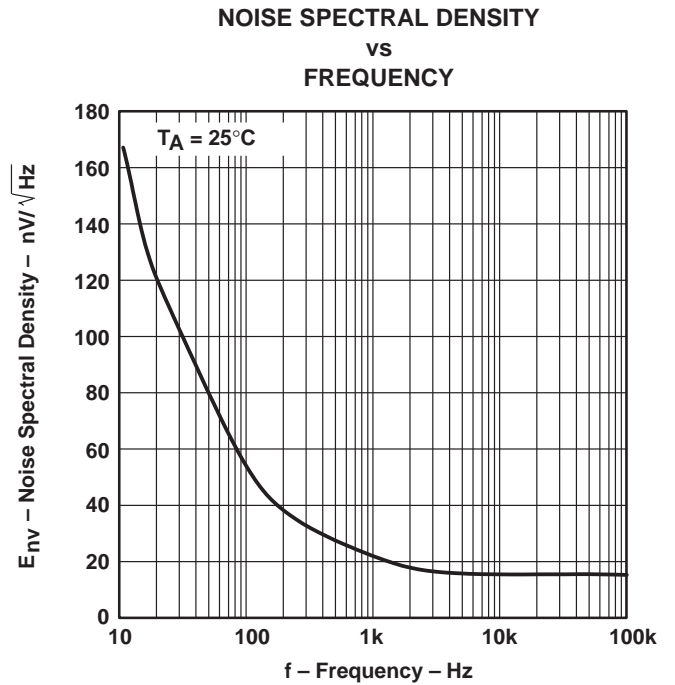

Figure 19

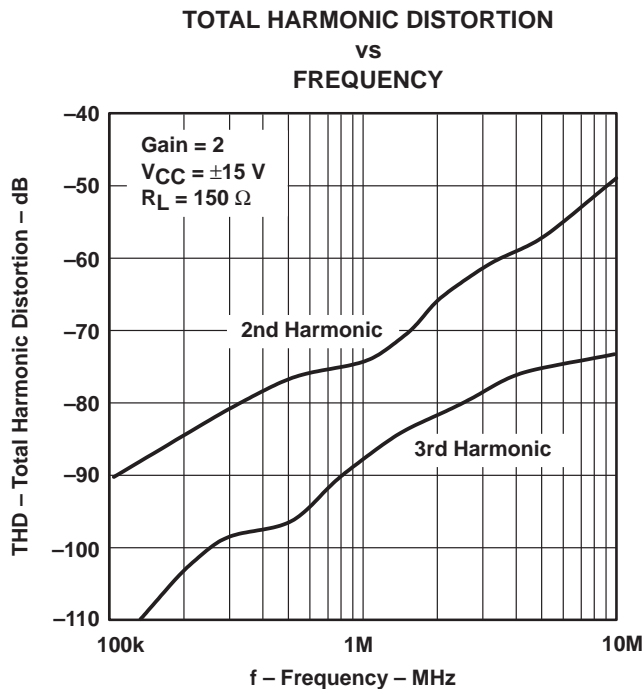

Figure 20

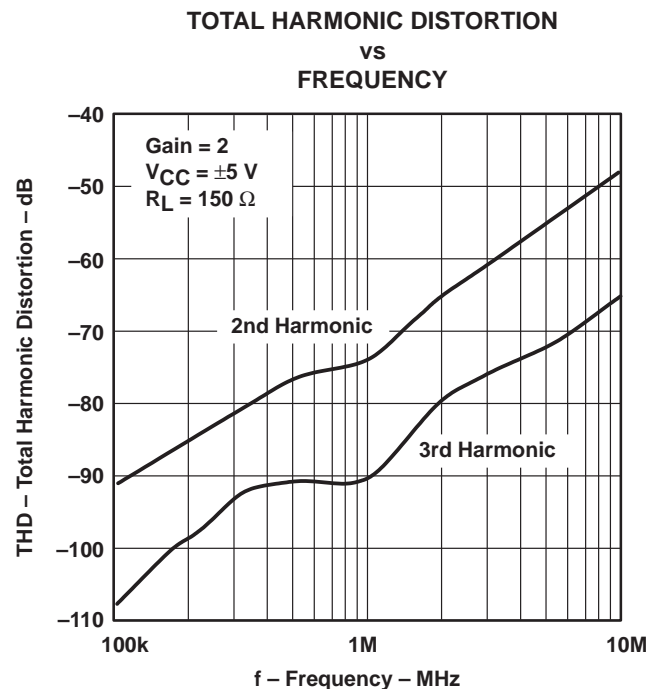

Figure 21

THS4061, THS4062 180-MHz HIGH-SPEED AMPLIFIERS

SLOS234D – DECEMBER 1998 – REVISED FEBRUARY 2000

APPLICATION INFORMATION

theory of operation

The THS406x is a high speed, operational amplifier configured in a voltage feedback architecture. It is built using a 30-V, dielectrically isolated, complementary bipolar process with NPN and PNP transistors possessing f_T s of several GHz. This results in an exceptionally high performance amplifier that has a wide bandwidth, high slew rate, fast settling time, and low distortion. A simplified schematic is shown in Figure 22.

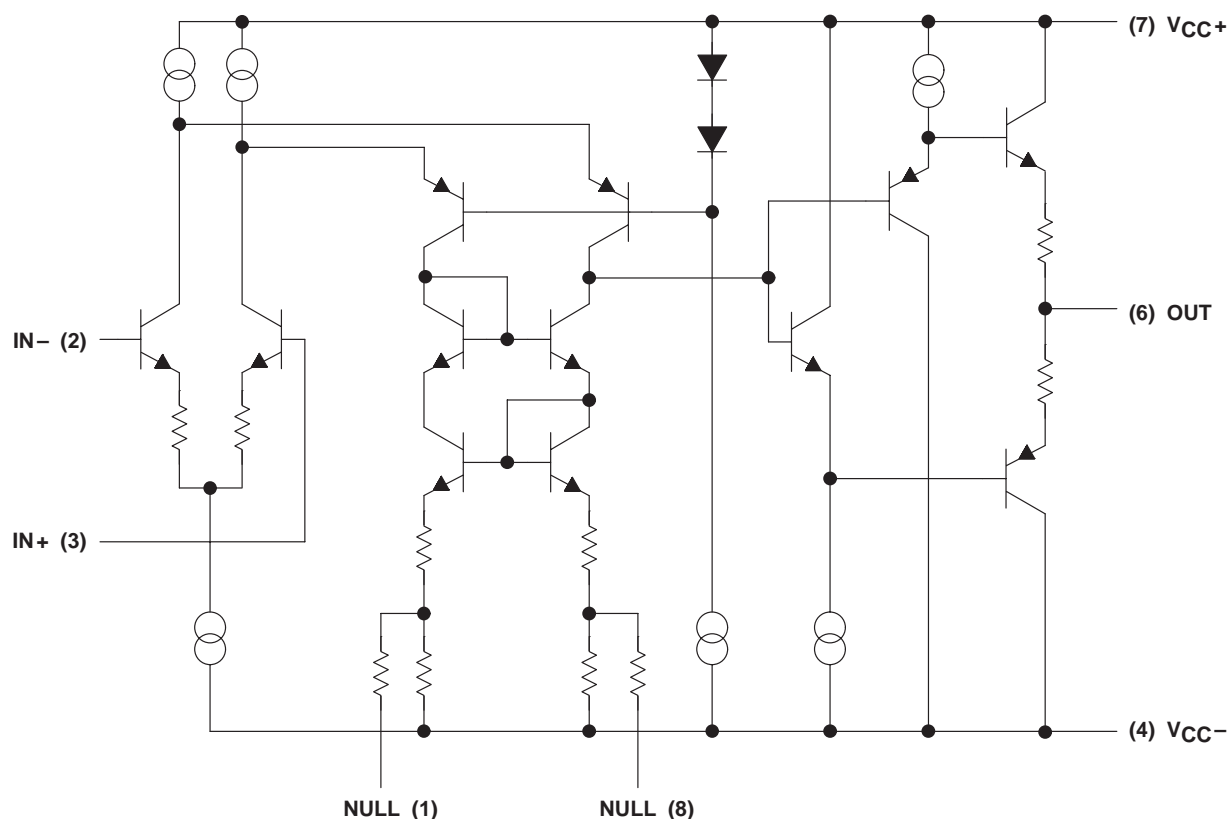

Figure 22. THS4061 Simplified Schematic

APPLICATION INFORMATION

offset nulling

The THS4061 has very low input offset voltage for a high-speed amplifier. However, if additional correction is required, an offset nulling function has been provided. By placing a potentiometer between terminals 1 and 8 and tying the wiper to the negative supply, the input offset can be adjusted. This is shown in Figure 23.

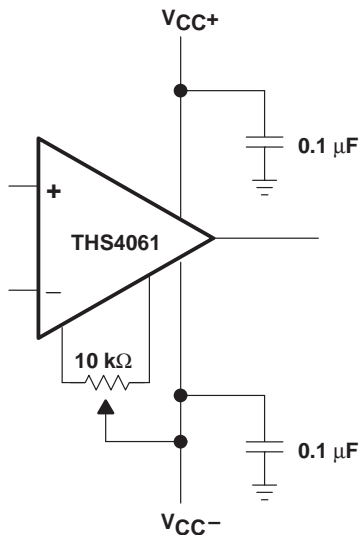

Figure 23. Offset Nulling Schematic

optimizing unity gain response

Internal frequency compensation of the THS406x was selected to provide very wideband performance yet still maintain stability when operated in a noninverting unity gain configuration. When amplifiers are compensated in this manner there is usually peaking in the closed loop response and some ringing in the step response for very fast input edges, depending upon the application. This is because a minimum phase margin is maintained for the $G=+1$ configuration. For optimum settling time and minimum ringing, a feedback resistor of $270\ \Omega$ should be used as shown in Figure 24. Additional capacitance can also be used in parallel with the feedback resistance if even finer optimization is required.

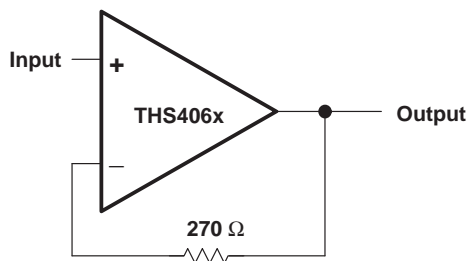

Figure 24. Noninverting, Unity Gain Schematic

APPLICATION INFORMATION

driving a capacitive load

Driving capacitive loads with high performance amplifiers is not a problem as long as certain precautions are taken. The first is to realize that the THS406x has been internally compensated to maximize its bandwidth and slew rate performance. When the amplifier is compensated in this manner, capacitive loading directly on the output will decrease the device's phase margin leading to high frequency ringing or oscillations. Therefore, for capacitive loads of greater than 10 pF, it is recommended that a resistor be placed in series with the output of the amplifier, as shown in Figure 25. A minimum value of 20 Ω should work well for most applications. For example, in 75- Ω transmission systems, setting the series resistor value to 75 Ω both isolates any capacitance loading and provides the proper line impedance matching at the source end.

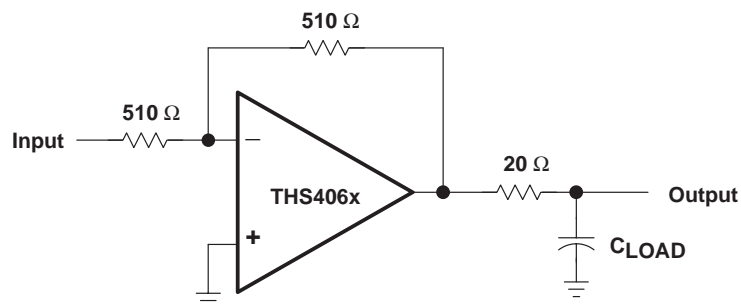

Figure 25. Driving a Capacitive Load

circuit layout considerations

In order to achieve the levels of high frequency performance of the THS406x, it is essential that proper printed-circuit board high frequency design techniques be followed. A general set of guidelines is given below. In addition, a THS406x evaluation board is available to use as a guide for layout or for evaluating the device performance.

- Ground planes – It is highly recommended that a ground plane be used on the board to provide all components with a low inductive ground connection. However, in the areas of the amplifier inputs and output, the ground plane can be removed to minimize the stray capacitance.
- Proper power supply decoupling – Use a 6.8- μ F tantalum capacitor in parallel with a 0.1- μ F ceramic capacitor on each supply terminal. It may be possible to share the tantalum among several amplifiers depending on the application, but a 0.1- μ F ceramic capacitor should always be used on the supply terminal of every amplifier. In addition, the 0.1- μ F capacitor should be placed as close as possible to the supply terminal. As this distance increases, the inductance in the connecting trace makes the capacitor less effective. The designer should strive for distances of less than 0.1 inches between the device power terminals and the ceramic capacitors.
- Sockets – Sockets are not recommended for high-speed operational amplifiers. The additional lead inductance in the socket pins will often lead to stability problems. Surface-mount packages soldered directly to the printed-circuit board is the best implementation.
- Short trace runs/compact part placements – Optimum high frequency performance is achieved when stray series inductance has been minimized. To realize this, the circuit layout should be made as compact as possible thereby minimizing the length of all trace runs. Particular attention should be paid to the inverting input of the amplifier. Its length should be kept as short as possible. This will help to minimize stray capacitance at the input of the amplifier.

APPLICATION INFORMATION

circuit layout considerations (continued)

- Surface-mount passive components – Using surface-mount passive components is recommended for high-frequency amplifier circuits for several reasons. First, because of the extremely low lead inductance of surface-mount components, the problem with stray series inductance is greatly reduced. Second, the small size of surface-mount components naturally leads to a more compact layout, thereby minimizing both stray inductance and capacitance. If leaded components are used, it is recommended that the lead lengths be kept as short as possible.

evaluation board

An evaluation board is available for the THS4061 (literature number SLOP226) and THS4062 (literature number SLOP235). This board has been configured for very low parasitic capacitance in order to realize the full performance of the amplifier. A schematic of the evaluation board is shown in Figure 26. The circuitry has been designed so that the amplifier may be used in either an inverting or noninverting configuration. To order the evaluation board contact your local TI sales office or distributor. For more detailed information, refer to the *THS4061 EVM User's Manual* (literature number SLOU038) or the *THS4062 EVM User's Manual* (literature number SLOU040)

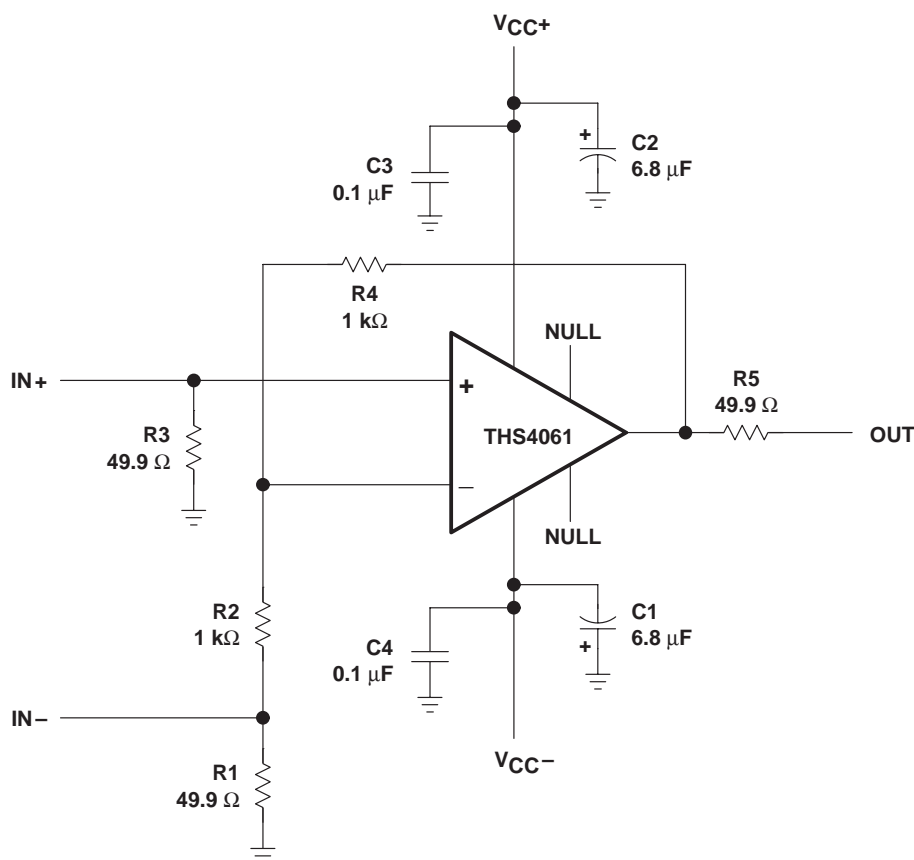

Figure 26. THS4061 Evaluation Board Schematic

THS4061, THS4062 180-MHz HIGH-SPEED AMPLIFIERS

SLOS234D – DECEMBER 1998 – REVISED FEBRUARY 2000

MECHANICAL INFORMATION

D (R-PDSO-G**)

PLASTIC SMALL-OUTLINE PACKAGE

14 PIN SHOWN

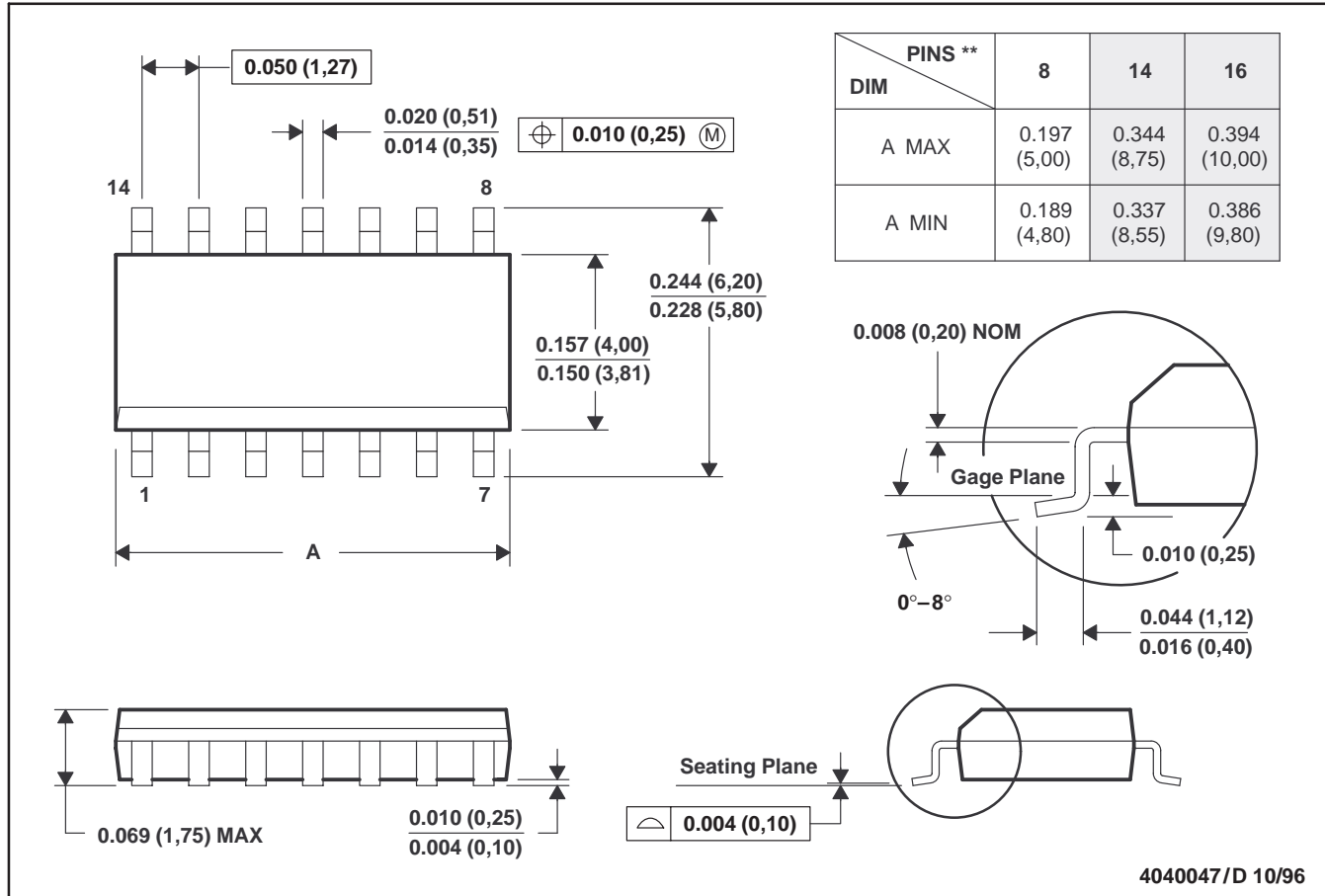

- NOTES: A. All linear dimensions are in inches (millimeters).
 B. This drawing is subject to change without notice.
 C. Body dimensions do not include mold flash or protrusion, not to exceed 0.006 (0,15).
 D. Falls within JEDEC MS-012

MECHANICAL INFORMATION

DGN (S-PDSO-G8)

PowerPAD™ PLASTIC SMALL-OUTLINE PACKAGE

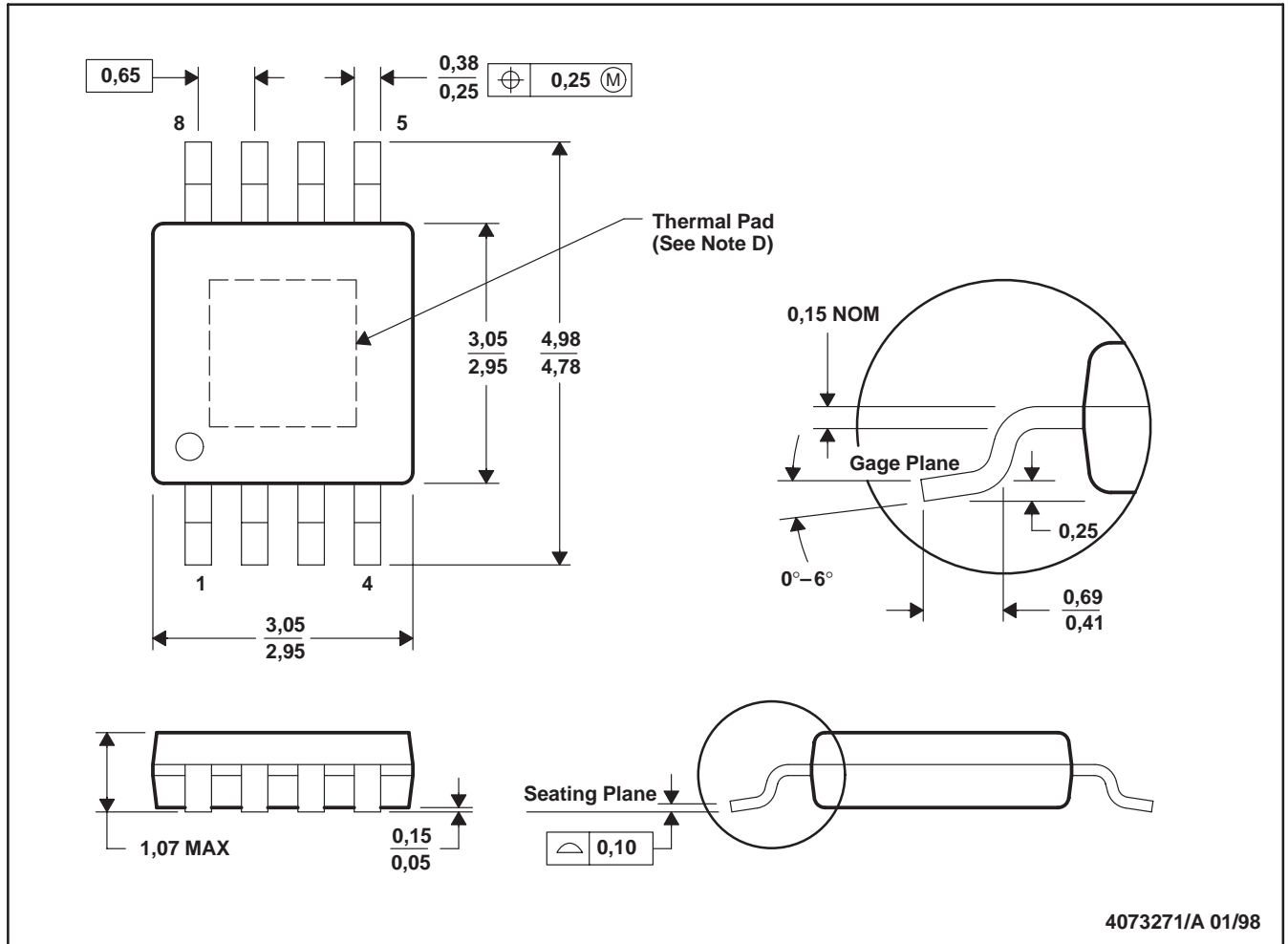

- NOTES: A. All linear dimensions are in millimeters.
 B. This drawing is subject to change without notice.
 C. Body dimensions include mold flash or protrusions.
 D. The package thermal performance may be enhanced by attaching an external heat sink to the thermal pad. This pad is electrically and thermally connected to the backside of the die and possibly selected leads.
 E. Falls within JEDEC MO-187

PowerPAD is a trademark of Texas Instruments Incorporated.

THS4061, THS4062 180-MHz HIGH-SPEED AMPLIFIERS

SLOS234D – DECEMBER 1998 – REVISED FEBRUARY 2000

MECHANICAL INFORMATION

FK (S-CQCC-N**)

LEADLESS CERAMIC CHIP CARRIER

28 TERMINAL SHOWN

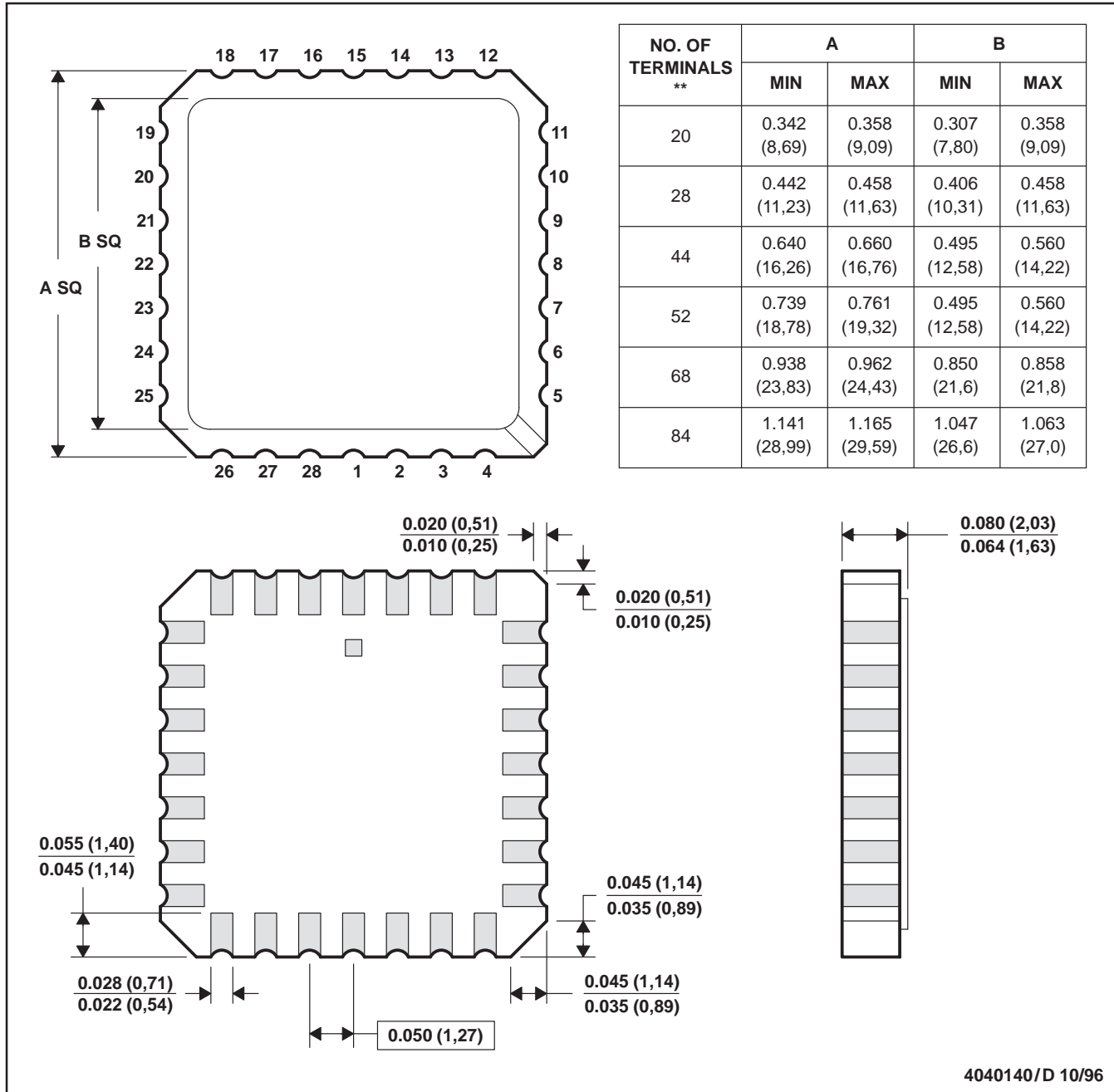

- NOTES:
- A. All linear dimensions are in inches (millimeters).
 - B. This drawing is subject to change without notice.
 - C. This package can be hermetically sealed with a metal lid.
 - D. The terminals are gold plated.
 - E. Falls within JEDEC MS-004

MECHANICAL INFORMATION

JG (R-GDIP-T8)

CERAMIC DUAL-IN-LINE PACKAGE

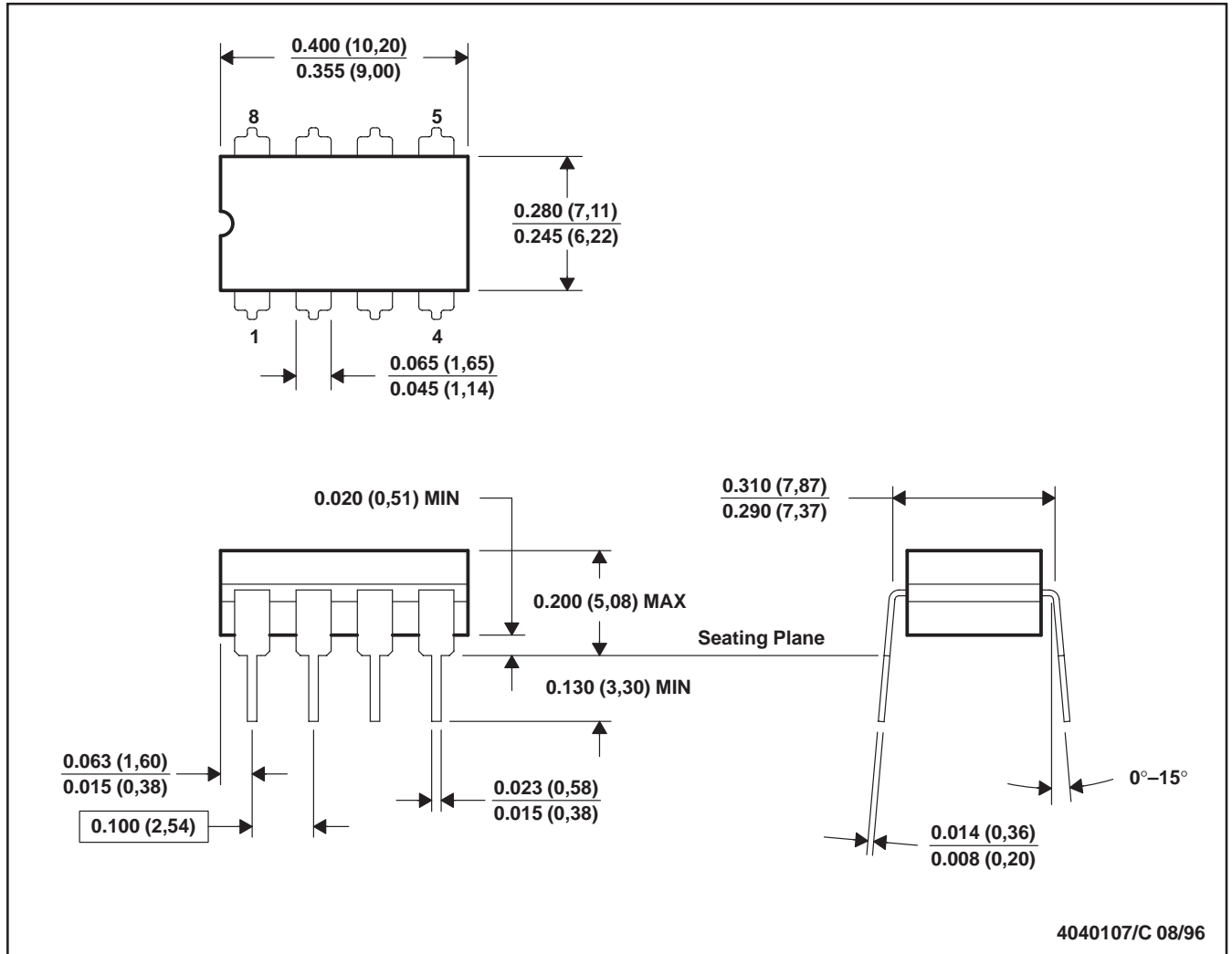

- NOTES: A. All linear dimensions are in inches (millimeters).
 B. This drawing is subject to change without notice.
 C. This package can be hermetically sealed with a ceramic lid using glass frit.
 D. Index point is provided on cap for terminal identification only on press ceramic glass frit seal only.
 E. Falls within MIL-STD-1835 GDIP1-T8

IMPORTANT NOTICE

Texas Instruments and its subsidiaries (TI) reserve the right to make changes to their products or to discontinue any product or service without notice, and advise customers to obtain the latest version of relevant information to verify, before placing orders, that information being relied on is current and complete. All products are sold subject to the terms and conditions of sale supplied at the time of order acknowledgement, including those pertaining to warranty, patent infringement, and limitation of liability.

TI warrants performance of its semiconductor products to the specifications applicable at the time of sale in accordance with TI's standard warranty. Testing and other quality control techniques are utilized to the extent TI deems necessary to support this warranty. Specific testing of all parameters of each device is not necessarily performed, except those mandated by government requirements.

CERTAIN APPLICATIONS USING SEMICONDUCTOR PRODUCTS MAY INVOLVE POTENTIAL RISKS OF DEATH, PERSONAL INJURY, OR SEVERE PROPERTY OR ENVIRONMENTAL DAMAGE ("CRITICAL APPLICATIONS"). TI SEMICONDUCTOR PRODUCTS ARE NOT DESIGNED, AUTHORIZED, OR WARRANTED TO BE SUITABLE FOR USE IN LIFE-SUPPORT DEVICES OR SYSTEMS OR OTHER CRITICAL APPLICATIONS. INCLUSION OF TI PRODUCTS IN SUCH APPLICATIONS IS UNDERSTOOD TO BE FULLY AT THE CUSTOMER'S RISK.

In order to minimize risks associated with the customer's applications, adequate design and operating safeguards must be provided by the customer to minimize inherent or procedural hazards.

TI assumes no liability for applications assistance or customer product design. TI does not warrant or represent that any license, either express or implied, is granted under any patent right, copyright, mask work right, or other intellectual property right of TI covering or relating to any combination, machine, or process in which such semiconductor products or services might be or are used. TI's publication of information regarding any third party's products or services does not constitute TI's approval, warranty or endorsement thereof.