

TL03x, TL03xA, TL03xY
ENHANCED-JFET LOW-POWER LOW-OFFSET
OPERATIONAL AMPLIFIERS

SLOS180B – FEBRUARY 1997 – REVISED FEBRUARY 1999

- Direct Upgrades for the TL06x Low-Power BiFETs
- Low Power Consumption . . . 6.5 mW/Channel Typ
- On-Chip Offset-Voltage Trimming for Improved DC Performance (1.5 mV, TL031A)
- Higher Slew Rate and Bandwidth Without Increased Power Consumption
- Available in TSSOP for Small Form-Factor Designs

description

The TL03x series of JFET-input operational amplifiers offer improved dc and ac characteristics over the TL06x family of low-power BiFET operational amplifiers. On-chip zener trimming of offset voltage yields precision grades as low as 1.5 mV (TL031A) for greater accuracy in dc-coupled applications. Texas Instruments improved BiFET process and optimized designs also yield improved bandwidths and slew rates without increased power consumption. The TL03x devices are pin-compatible with the TL06x and can be used to upgrade existing circuits or for optimal performance in new designs.

BiFET operational amplifiers offer the inherently higher input impedance of the JFET-input transistors without sacrificing the output drive associated with bipolar amplifiers. This higher input impedance makes the TL3x amplifiers better suited for interfacing with high-impedance sensors or very low-level ac signals. These devices also feature inherently better ac response than bipolar or CMOS devices having comparable power consumption.

The TL03x family has been optimized for micropower operation, while improving on the performance of the TL06x series. Designers requiring significantly faster ac response should consider the Excalibur TLE206x family of low-power BiFET operational amplifiers.

Because BiFET operational amplifiers are designed for use with dual power supplies, care must be taken to observe common-mode input-voltage limits and output swing when operating from a single supply. DC biasing of the input signal is required and loads should be terminated to a virtual-ground node at midsupply. Texas Instruments TLE2426 integrated virtual-ground generator is useful when operating BiFET amplifiers from single supplies.

The TL03x devices are fully specified at ± 15 V and ± 5 V. For operation in low-voltage and/or single-supply systems, Texas Instruments LinCMOS families of operational amplifiers (TLC-prefix) are recommended. When moving from BiFET to CMOS amplifiers, particular attention should be paid to slew rate, bandwidth requirements, and output loading.

The C-suffix devices are characterized for operation from 0°C to 70°C. The I-suffix devices are characterized for operation from -40°C to 85°C. The M-suffix devices are characterized for operation over the full military temperature range of -55°C to 125°C.



Please be aware that an important notice concerning availability, standard warranty, and use in critical applications of Texas Instruments semiconductor products and disclaimers thereto appears at the end of this data sheet.

PRODUCTION DATA information is current as of publication date. Products conform to specifications per the terms of Texas Instruments standard warranty. Production processing does not necessarily include testing of all parameters.

TEXAS
INSTRUMENTS

POST OFFICE BOX 655303 • DALLAS, TEXAS 75265

Copyright © 1999, Texas Instruments Incorporated

TL03x, TL03xA, TL03xY ENHANCED-JFET LOW-POWER LOW-OFFSET OPERATIONAL AMPLIFIERS

SLOS180B – FEBRUARY 1997 – REVISED FEBRUARY 1999

TL031x, TL031Ax
D, JG, OR P PACKAGE
(TOP VIEW)

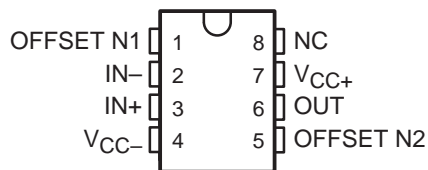

TL032x, TL032Ax
D, JG, OR P PACKAGE
(TOP VIEW)

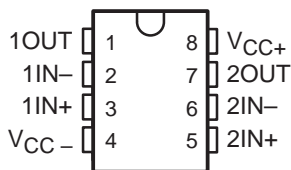

TL034x, TL034Ax
D, J, N, OR PW PACKAGE
(TOP VIEW)

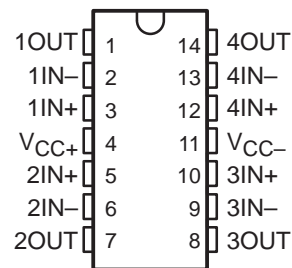

TL031M, TL031AM
FK PACKAGE
(TOP VIEW)

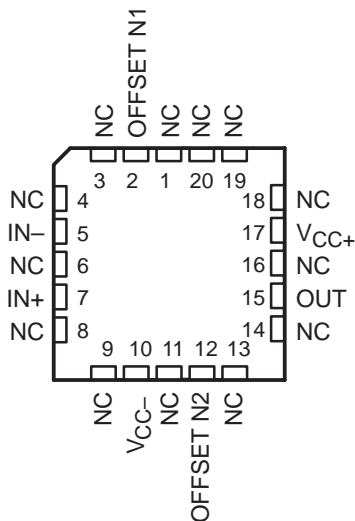

TL032M, TL032AM
FK PACKAGE
(TOP VIEW)

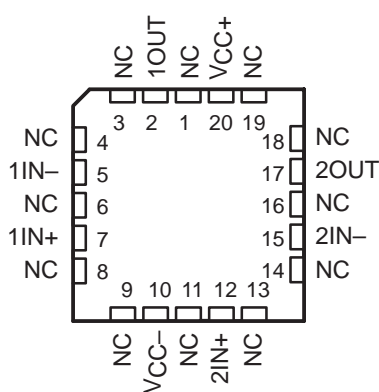

TL034M, TL034AM
FK PACKAGE
(TOP VIEW)

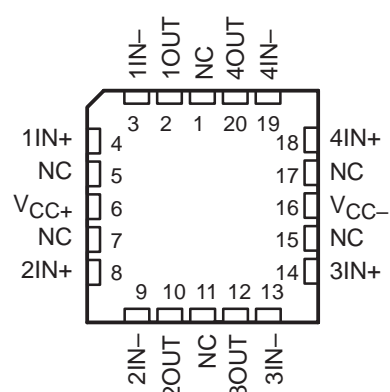

NC – No internal connection

TL03x, TL03xA, TL03xY ENHANCED-JFET LOW-POWER LOW-OFFSET OPERATIONAL AMPLIFIERS

SLOS180B – FEBRUARY 1997 – REVISED FEBRUARY 1999

AVAILABLE OPTIONS

T _A	V _{IO} MAX AT 25°C	PACKAGED DEVICES							CHIP FORM‡ (Y)
		SMALL OUTLINE† (D)	CHIP CARRIER (FK)	CERAMIC DIP (J)	CERAMIC DIP (JG)	PLASTIC DIP (N)	PLASTIC DIP (P)	TSSOP† (PW)	
0°C to 70°C	0.8 mV	TL031ACD TL032ACD	—	—	—	—	TL031ACP TL032ACP	—	TL031Y TL032Y TL034Y
	1.5 mV	TL031CD TL032CD TL034ACD	—	—	—	TL034ACN	TL031CP TL032CP	—	
	4 mV	TL034CD	—	—	—	TL034CN	—	TL034CPW	
–40°C to 85°C	0.8 mV	TL031AID TL032AID	—	—	—	—	TL031AIP TL032AIP	—	—
	1.5 mV	TL031ID TL032ID TL034AID	—	—	—	TL034AIN	TL031IP TL032IP	—	—
	4 mV	TL034ID	—	—	—	TL034IN	—	—	—
–55°C to 125°C	0.8 mV	TL031AMD TL032AMD	TL031AMFK TL032AMFK	—	TL031AMJG TL032AMJG	—	TL031AMP TL032AMP	—	—
	1.5 mV	TL031MD TL032MD TL034AMD	TL031MFK TL032MFK TL034AMFK	TL034AMJ	TL031MJG TL032MJG	TL034AMN	TL031MP TL032MP	—	—
	4 mV	TL034MD	TL034MFK	TL034MJ	—	TL034MN	—	—	—

† The D and PW packages are available taped and reeled and are indicated by adding an R suffix to device type (e.g., TL034CDR or TL034CPWR).

‡ Chip forms are tested at 25°C.

TL03x, TL03xA, TL03xY ENHANCED-JFET LOW-POWER LOW-OFFSET OPERATIONAL AMPLIFIERS

SLOS180B – FEBRUARY 1997 – REVISED FEBRUARY 1999

symbol (each amplifier)

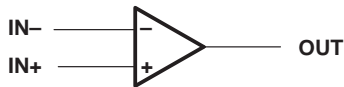

equivalent schematic (each amplifier)

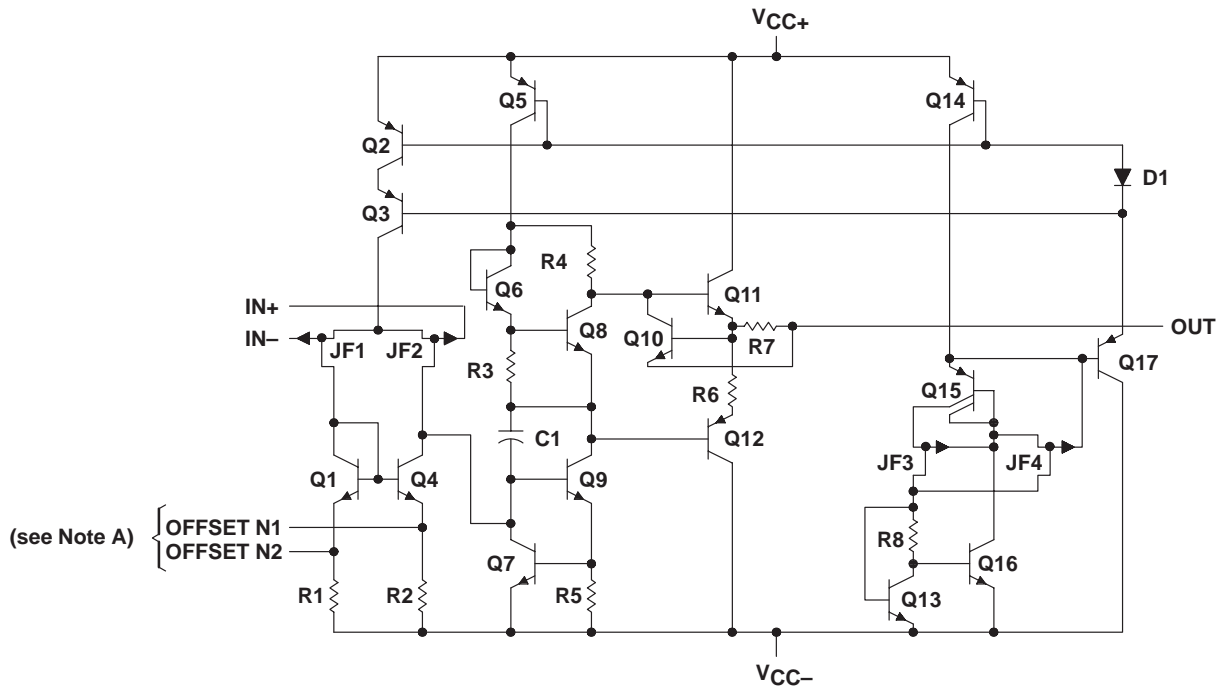

NOTE A: OFFSET N1 and OFFSET N2 are available only on the TL031.

TL03x, TL03xA, TL03xY ENHANCED-JFET LOW-POWER LOW-OFFSET OPERATIONAL AMPLIFIERS

SLOS180B – FEBRUARY 1997 – REVISED FEBRUARY 1999

TL031Y chip information

This chip, when properly assembled, has characteristics similar to the TL031C. Thermal compression or ultrasonic bonding can be used on the doped-aluminum bonding pads. These chips can be mounted with conductive epoxy or a gold-silicon preform.

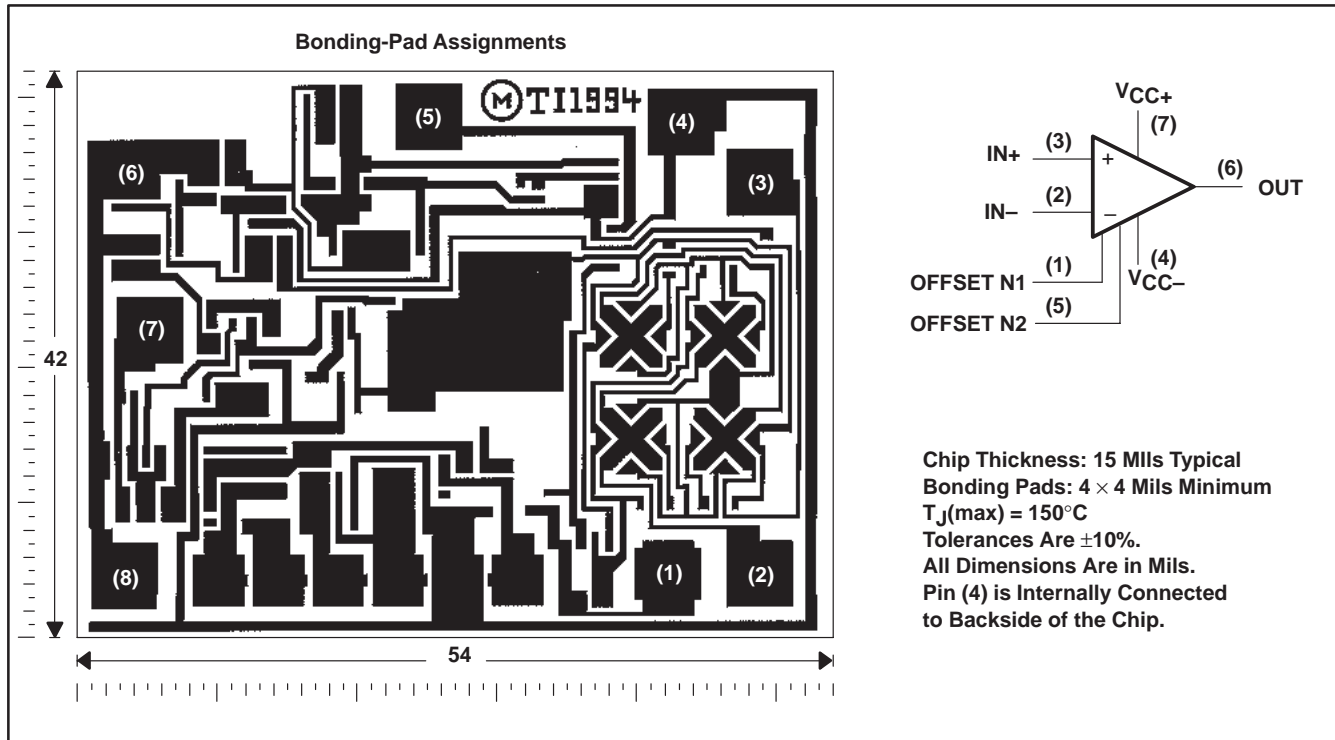

TL03x, TL03xA, TL03xY ENHANCED-JFET LOW-POWER LOW-OFFSET OPERATIONAL AMPLIFIERS

SLOS180B – FEBRUARY 1997 – REVISED FEBRUARY 1999

TL032Y chip information

This chip, when properly assembled, has characteristics similar to the TL032C. Thermal compression or ultrasonic bonding can be used on the doped-aluminum bonding pads. These chips can be mounted with conductive epoxy or a gold-silicon preform.

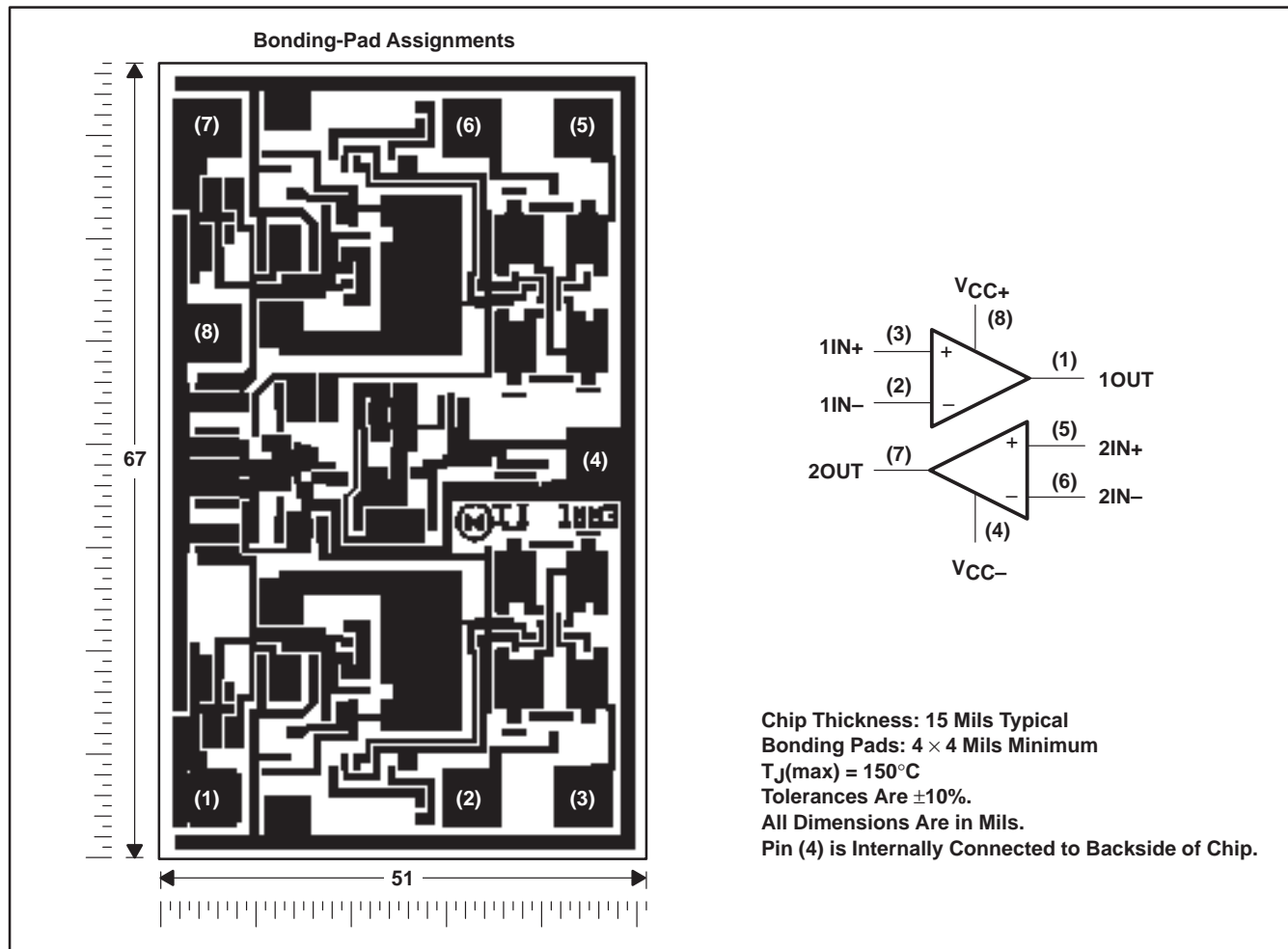

TL03x, TL03xA, TL03xY
 ENHANCED-JFET LOW-POWER LOW-OFFSET
 OPERATIONAL AMPLIFIERS

SLOS180B – FEBRUARY 1997 – REVISED FEBRUARY 1999

TL034Y chip information

This chip, when properly assembled, has characteristics similar to the TL034C. Thermal compression or ultrasonic bonding can be used on the doped-aluminum bonding pads. These chips can be mounted with conductive epoxy or a gold-silicon preform.

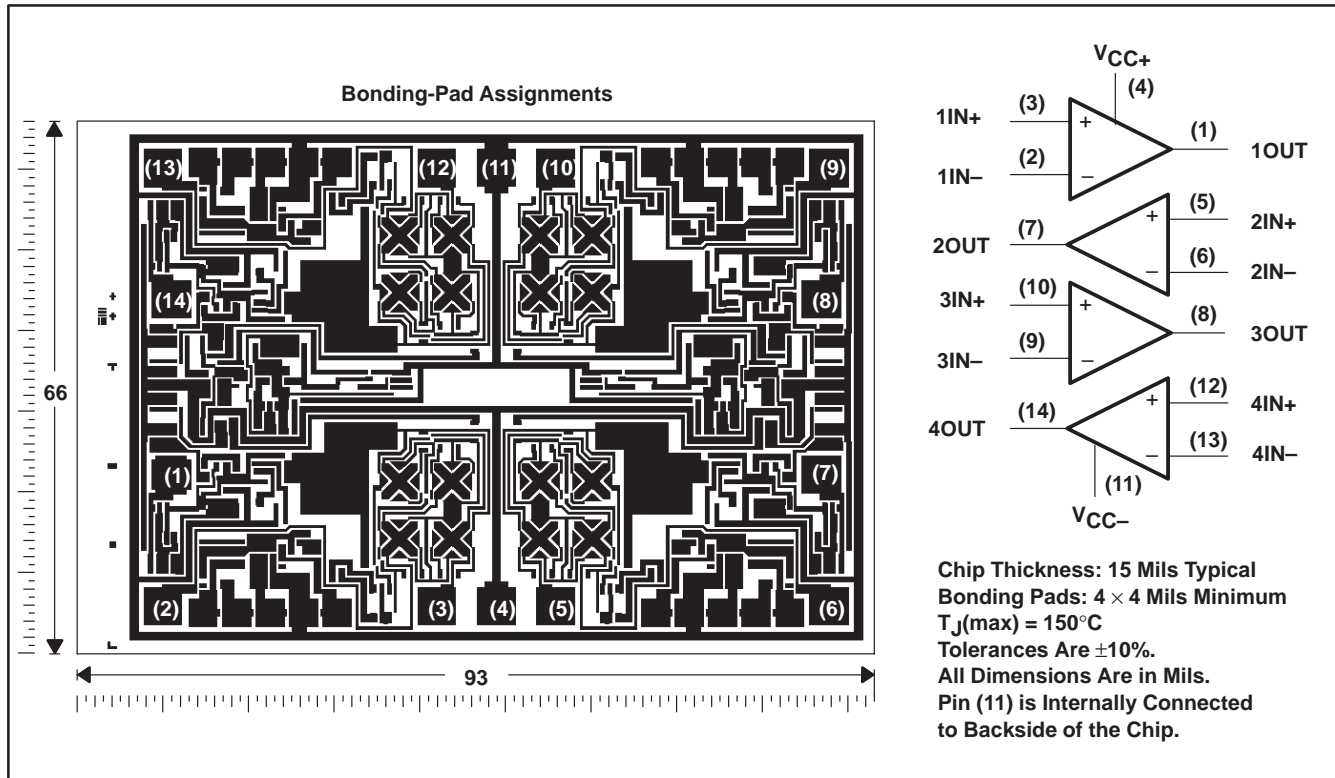

TL03x, TL03xA, TL03xY ENHANCED-JFET LOW-POWER LOW-OFFSET OPERATIONAL AMPLIFIERS

SLOS180B – FEBRUARY 1997 – REVISED FEBRUARY 1999

absolute maximum ratings over operating free-air temperature range (unless otherwise noted)†

Supply voltage, V_{CC+} (see Note 1)	18 V
Supply voltage, V_{CC-} (see Note 1)	-18 V
Differential input voltage, V_{ID} (see Note 2)	± 30 V
Input voltage, V_I (any input) (see Notes 1 and 3)	± 15 V
Input current, I_I (each input)	± 1 mA
Output current, I_O (each output)	± 40 mA
Total current into V_{CC+}	160 mA
Total current out of V_{CC-}	160 mA
Duration of short-circuit current at (or below) 25°C (see Note 4)	Unlimited
Continuous total power dissipation	See Dissipation Rating Table
Storage temperature range, T_{stg}	-65°C to 150°C
Case temperature for 60 seconds: FK package	260°C
Lead temperature 1,6 mm (1/16 inch) from case for 10 seconds: D, N, P, or PW package	260°C
Lead temperature 1,6 mm (1/16 inch) from case for 60 seconds: J or JG package	300°C

† Stresses beyond those listed under “absolute maximum ratings” may cause permanent damage to the device. These are stress ratings only, and functional operation of the device at these or any other conditions beyond those indicated under “recommended operating conditions” is not implied. Exposure to absolute-maximum-rated conditions for extended periods may affect device reliability.

- NOTES:
1. All voltage values, except differential voltages, are with respect to the midpoint between V_{CC+} and V_{CC-} .
 2. Differential voltages are at $IN+$ with respect to $IN-$.
 3. The magnitude of the input voltage must never exceed the magnitude of the supply voltage or 15 V, whichever is less.
 4. The output may be shorted to either supply. Temperature and/or supply voltages must be limited to ensure that the maximum dissipation rating is not exceeded.

DISSIPATION RATING TABLE

PACKAGE	$T_A \leq 25^\circ\text{C}$ POWER RATING	DERATING FACTOR ABOVE $T_A = 25^\circ\text{C}$	$T_A = 70^\circ\text{C}$ POWER RATING	$T_A = 85^\circ\text{C}$ POWER RATING	$T_A = 125^\circ\text{C}$ POWER RATING
D	950 mW	7.6 mW/°C	608 mW	494 mW	190 mW
FK	1375 mW	11.0 mW/°C	880 mW	715 mW	275 mW
J	1375 mW	11.0 mW/°C	880 mW	715 mW	275 mW
JG	1050 mW	8.4 mW/°C	672 mW	546 mW	210 mW
N	1150 mW	9.2 mW/°C	736 mW	598 mW	230 mW
P	1100 mW	8.0 mW/°C	640 mW	520 mW	200 mW
PW	700 mW	5.6 mW/°C	448 mW	N/A	N/A

recommended operating conditions

		C SUFFIX		I SUFFIX		M SUFFIX		UNIT
		MIN	MAX	MIN	MAX	MIN	MAX	
Supply voltage, $V_{CC\pm}$		± 5	± 15	± 5	± 15	± 5	± 15	V
Common-mode input voltage, V_{IC}	$V_{CC\pm} = \pm 5$ V	-1.5	4	-1.5	4	-1.5	4	V
	$V_{CC\pm} = \pm 15$ V	-11.5	14	-11.5	14	-11.5	14	
Operating free-air temperature, T_A		0	70	-40	85	-55	125	°C



TL03x, TL03xA, TL03xY
ENHANCED-JFET LOW-POWER LOW-OFFSET
OPERATIONAL AMPLIFIERS

SLOS180B – FEBRUARY 1997 – REVISED FEBRUARY 1999

TL031C and TL031AC electrical characteristics at specified free-air temperature

PARAMETER	TEST CONDITIONS	T _A	TL031C, TL031AC						UNIT
			V _{CC±} = ±5 V			V _{CC±} = ±15 V			
			MIN	TYP	MAX	MIN	TYP	MAX	
V _{IO} Input offset voltage	V _O = 0, V _{IC} = 0, R _S = 50 Ω	TL031C	25°C	0.54 3.5		0.5 1.5		mV	
			Full range†	4.5		2.5			
		TL031AC	25°C	0.41 2.8		0.34 0.8			
			Full range†	3.8		1.8			
α _{VIO} Temperature coefficient of input offset voltage	V _O = 0, V _{IC} = 0, R _S = 50 Ω	TL031C	25°C to 70°C	7.1		5.9		μV/°C	
		TL031AC	25°C to 70°C	7.1		5.9 25			
Input offset voltage long-term drift‡			25°C	0.04		0.04		μV/mo	
I _{IO} Input offset current	V _O = 0, V _{IC} = 0, See Figure 5		25°C	1 100		1 100		pA	
			70°C	9 200		12 200			
I _{IB} Input bias current	V _O = 0, V _{IC} = 0, See Figure 5		25°C	2 200		2 200		pA	
			70°C	50 400		80 400			
V _{ICR} Common-mode input voltage range			25°C	-1.5 to 4	-3.4 to 5.4	-11.5 to 14	-13.4 to 15.4	V	
		Full range†		-1.5 to .4		-11.5 to 14			
V _{OM+} Maximum positive peak output voltage swing	R _L = 10 kΩ		25°C	3 4.3		13 14		V	
			0°C	3 4.2		13 14			
			70°C	3 4.3		13 14			
V _{OM-} Maximum negative peak output voltage swing	R _L = 10 kΩ		25°C	-3 -4.2		-12.5 -13.9		V	
			0°C	-3 -4.1		-12.5 -13.9			
			70°C	-3 -4.2		-12.5 -14			
A _{VD} Large-signal differential voltage amplification§	R _L = 10 kΩ		25°C	4 12		5 14.3		V/mV	
			0°C	3 11.1		4 13.5			
			70°C	4 13.3		5 15.2			
r _i Input resistance			25°C	10 ¹²		10 ¹²		Ω	
c _i Input capacitance			25°C	5		4		pF	
CMRR Common-mode rejection ratio	V _{IC} = V _{ICRmin} , V _O = 0, R _S = 50 Ω		25°C	70 87		75 94		dB	
			0°C	70 87		75 94			
			70°C	70 87		75 94			
k _{SVR} Supply-voltage rejection ratio (ΔV _{CC±} /ΔV _{IO})	V _O = 0, R _S = 50 Ω		25°C	75 96		75 96		dB	
			0°C	75 96		75 96			
			70°C	75 96		75 96			

† Full range is 0°C to 70°C.

‡ Typical values are based on the input offset voltage shift observed through 168 hours of operating life test at T_A = 150°C extrapolated to T_A = 25°C using the Arrhenius equation and assuming an activation energy of 0.96 eV.

§ At V_{CC±} = ±5 V, V_O = ±2.3 V; at V_{CC±} = ±15 V, V_O = ±10 V.



TL03x, TL03xA, TL03xY ENHANCED-JFET LOW-POWER LOW-OFFSET OPERATIONAL AMPLIFIERS

SLOS180B – FEBRUARY 1997 – REVISED FEBRUARY 1999

TL031C and TL031AC electrical characteristics at specified free-air temperature (continued)

PARAMETER	TEST CONDITIONS	T _A	TL031C, TL031AC						UNIT
			V _{CC±} = ±5 V			V _{CC±} = ±15 V			
			MIN	TYP	MAX	MIN	TYP	MAX	
P _D Total power dissipation	V _O = 0, No load	25°C		1.9	2.5		6.5	8.4	mW
		0°C		1.8	2.5		6.3	8.4	
		70°C		1.9	2.5		6.3	8.4	
I _{CC} Supply current	V _O = 0, No load	25°C		192	250		217	280	μA
		0°C		184	250		211	280	
		70°C		189	250		210	280	

TL031C and TL031AC operating characteristics at specified free-air temperature

PARAMETER	TEST CONDITIONS	T _A	TL031C, TL031AC						UNIT
			V _{CC±} = ±5 V			V _{CC±} = ±15 V			
			MIN	TYP	MAX	MIN	TYP	MAX	
SR+ Positive slew rate at unity gain†	R _L = 10 kΩ, C _L = 100 pF, See Figure 1	25°C		2		1.5	2.9	V/μs	
		0°C		1.8		1	2.6		
		70°C		2.2		1.5	3.2		
SR- Negative slew rate at unity gain†		R _L = 10 kΩ, C _L = 100 pF, See Figure 1	25°C		3.9		1.5	5.1	V/μs
			0°C		3.7		1.5	5	
			70°C		4		1.5	5	
t _r Rise time	V _{I(PP)} = ±10 mV, R _L = 10 kΩ, C _L = 100 pF, See Figures 1 and 2		25°C		138		132	ns	
			0°C		134		127		
			70°C		150		142		
t _f Fall time	V _{I(PP)} = ±10 mV, R _L = 10 kΩ, C _L = 100 pF, See Figure 1	25°C		138		132	ns		
		0°C		134		127			
		70°C		150		142			
Overshoot factor	V _{I(PP)} = ±10 mV, C _L = 100 pF, C _L = 100 pF, See Figures 1 and 2	25°C		11%		5%			
		0°C		10%		4%			
		70°C		12%		6%			
V _n Equivalent input noise voltage	R _S = 20 Ω, See Figure 3	25°C	TL031C	f = 10 Hz		61	61	nV/√Hz	
			TL031AC	f = 1 kHz		41	41		
		25°C	TL031C	f = 10 Hz		61	61		
			TL031AC	f = 1 kHz		41	41		60
I _n Equivalent input noise current	f = 1 kHz	25°C		0.003		0.003	pA/√Hz		
B ₁ Unity-gain bandwidth	V _I = 10 mV, C _L = 25 pF, R _L = 10 kΩ, See Figure 4	25°C		1		1.1	MHz		
		0°C		1		1.1			
		70°C		1		1			
φ _m Phase margin at unity gain	V _I = 10 mV, C _L = 25 pF, R _L = 10 kΩ, See Figure 4	25°C		61°		65°			
		0°C		61°		65°			
		70°C		60°		64°			

† For V_{CC±} = ±5 V, V_{I(PP)} = ±1 V; for V_{CC±} = ±15 V, V_{I(PP)} = ±5 V.



TL03x, TL03xA, TL03xY
ENHANCED-JFET LOW-POWER LOW-OFFSET
OPERATIONAL AMPLIFIERS

SLOS180B – FEBRUARY 1997 – REVISED FEBRUARY 1999

TL031I and TL031AI electrical characteristics at specified free-air temperature

PARAMETER	TEST CONDITIONS		T _A	TL031I, TL031AI						UNIT
				V _{CC±} = ±5 V			V _{CC±} = ±15 V			
				MIN	TYP	MAX	MIN	TYP	MAX	
V _{IO} Input offset voltage		TL031I	25°C	0.54	3.5	0.5	1.5	mV		
			Full range†	5.3		3.3				
		TL031AI	25°C	0.41	2.8	0.34	0.8			
			Full range†	4.6		2.6				
α _{VIO} Temperature coefficient of input offset voltage	V _O = 0, V _{IC} = 0, R _S = 50 Ω	TL031I	25°C to 85°C	6.5		6.2		μV/°C		
		TL031AI	25°C to 85°C	6.5		6.2 25				
Input offset voltage long-term drift‡			25°C	0.04		0.04		μV/mo		
I _{IO} Input offset current	V _O = 0, V _{IC} = 0, See Figure 5		25°C	1	100	1	100	pA		
			85°C	0.02	0.45	0.02	0.45	nA		
I _{IB} Input bias current	V _O = 0, V _{IC} = 0, See Figure 5		25°C	2	200	2	200	pA		
			85°C	0.2	0.9	0.2	0.9	nA		
V _{ICR} Common-mode input voltage range			25°C	-1.5 to 4	-3.4 to 5.4	-11.5 to 14	-13.4 to 15.4	V		
		Full range†		-1.5 to 4		-11.5 to 14				
V _{OM+} Maximum positive peak output voltage swing	R _L = 10 kΩ		25°C	3	4.3	13	14	V		
			-40°C	3	4.1	13	14			
			85°C	3	4.4	13	14			
V _{OM-} Maximum negative peak output voltage swing	R _L = 10 kΩ		25°C	-3	-4.2	-12.5	-13.9	V		
			-40°C	-3	-4.1	-12.5	-13.8			
			85°C	-3	-4.2	-12.5	-14			
A _{VD} Large-signal differential voltage amplification§	R _L = 10 kΩ		25°C	4	12	5	14.3	V/mV		
			-40°C	3	8.4	4	11.6			
			85°C	4	13.5	5	15.3			
r _i Input resistance			25°C	10 ¹²		10 ¹²		Ω		
c _i Input capacitance			25°C	5		4		pF		
CMRR Common-mode rejection ratio	V _{IC} = V _{ICRmin} , V _O = 0, R _S = 50 Ω		25°C	70	87	75	94	dB		
			-40°C	70	87	75	94			
			85°C	70	87	75	94			
k _{SVR} Supply-voltage rejection ratio (ΔV _{CC±} /ΔV _{IO})	V _O = 0, R _S = 50 Ω		25°C	75	96	75	96	dB		
			-40°C	75	96	75	96			
			85°C	75	96	75	96			

† Full range is -40°C to 85°C.

‡ Typical values are based on the input offset voltage shift observed through 168 hours of operating life test at T_A = 150°C extrapolated to T_A = 25°C using the Arrhenius equation and assuming an activation energy of 0.96 eV.

§ At V_{CC±} = ±5 V, V_O = ±2.3 V; at V_{CC±} = ±15 V, V_O = ±10 V.



TL03x, TL03xA, TL03xY ENHANCED-JFET LOW-POWER LOW-OFFSET OPERATIONAL AMPLIFIERS

SLOS180B – FEBRUARY 1997 – REVISED FEBRUARY 1999

TL031I and TL031AI electrical characteristics at specified free-air temperature (continued)

PARAMETER	TEST CONDITIONS	T _A	TL031I, TL031AI						UNIT
			V _{CC±} = ±5 V			V _{CC±} = ±15 V			
			MIN	TYP	MAX	MIN	TYP	MAX	
P _D Total power dissipation	V _O = 0, No load	25°C	1.9	2.5	6.5	8.4	mW		
		-40°C	1.4	2.5	5.4	8.4			
		85°C	1.9	2.5	6.2	8.4			
I _{CC} Supply current	V _O = 0, No load	25°C	192	250	217	280	μA		
		-40°C	144	250	181	280			
		85°C	189	250	207	280			

TL031I and TL031AI operating characteristics at specified free-air temperature

PARAMETER	TEST CONDITIONS	T _A	TL031I, TL031AI						UNIT
			V _{CC±} = ±5 V			V _{CC±} = ±15 V			
			MIN	TYP	MAX	MIN	TYP	MAX	
SR ⁺ Positive slew rate at unity gain†	R _L = 10 kΩ, C _L = 100 pF, See Figure 1	25°C	2			1.5 2.9			V/μs
		-40°C	1.6			1 2.1			
		85°C	2.3			1.5 3.3			
SR ⁻ Negative slew rate at unity gain†		25°C	3.9			1.5 5.1			V/μs
		-40°C	3.3			1.5 4.8			
		85°C	4.1			1.5 4.9			
t _r Rise time	V _{I(PP)} = ±10 mV, R _L = 10 kΩ, C _L = 100 pF, See Figures 1 and 2	25°C	138			132			ns
		-40°C	132			123			
		85°C	154			146			
t _f Fall time	V _{I(PP)} = ±10 mV, R _L = 10 kΩ, C _L = 100 pF, See Figure 1	25°C	138			132			ns
		-40°C	132			123			
		85°C	154			146			
Overshoot factor	V _{I(PP)} = ±10 mV, R _L = 10 kΩ, C _L = 100 pF, See Figures 1 and 2	25°C	11%			5%			
		-40°C	12%			5%			
		85°C	13%			7%			
V _n Equivalent input noise voltage	R _S = 20 Ω, See Figure 3	25°C	f = 10 Hz			61			nV/√Hz
			f = 1 kHz			41			
		25°C	f = 10 Hz			61			
			f = 1 kHz			41 60			
I _n Equivalent input noise current	f = 1 kHz	25°C	0.003			0.003			pA/√Hz
B ₁ Unity-gain bandwidth	V _I = 10 mV, C _L = 25 pF, R _L = 10 kΩ, See Figure 4	25°C	1			1.1			MHz
		-40°C	1			1.1			
		85°C	0.9			1			
φ _m Phase margin at unity gain	V _I = 10 mV, C _L = 25 pF, R _L = 10 kΩ, See Figure 4	25°C	61°			65°			
		-40°C	60°			65°			
		85°C	60°			64°			

† For V_{CC±} = ±5 V, V_{I(PP)} = ±1 V; for V_{CC±} = ±15 V, V_{I(PP)} = ±5 V.



TL03x, TL03xA, TL03xY
ENHANCED-JFET LOW-POWER LOW-OFFSET
OPERATIONAL AMPLIFIERS

SLOS180B – FEBRUARY 1997 – REVISED FEBRUARY 1999

TL031M and TL031AM electrical characteristics at specified free-air temperature

PARAMETER	TEST CONDITIONS	T _A	TL031M, TL031AM						UNIT
			V _{CC±} = ±5 V			V _{CC±} = ±15 V			
			MIN	TYP	MAX	MIN	TYP	MAX	
V _{IO} Input offset voltage	V _O = 0, V _{IC} = 0, R _S = 50 Ω	TL031M	25°C	0.54 3.5		0.5 1.5		mV	
			Full range†	6.5		4.5			
		TL031AM	25°C	0.41 2.8		0.34 0.8			
			Full range†	5.8		3.8			
α _{VIO} Temperature coefficient of input offset voltage	V _O = 0, V _{IC} = 0, R _S = 50 Ω	TL031M	25°C to 125°C	5.1		4.3		μV/°C	
		TL031AM	25°C to 125°C	5.1		4.3			
Input offset voltage long-term drift‡			25°C	0.04		0.04		μV/mo	
I _{IO} Input offset current	V _O = 0, V _{IC} = 0, See Figure 5		25°C	1	100	1	100	pA	
			125°C	0.2	10	0.2	10	nA	
I _{IB} Input bias current	V _O = 0, V _{IC} = 0, See Figure 5		25°C	2	200	2	200	pA	
			125°C	7	20	8	20	nA	
V _{ICR} Common-mode input voltage range			25°C	-1.5 to 4	-3.4 to 5.4	-11.5 to 14	-13.4 to 15.4	V	
			Full range†	-1.5 to 4		-11.5 to 14			
V _{OM+} Maximum positive peak output voltage swing	R _L = 10 kΩ		25°C	3	4.3	13	14	V	
			-55°C	3	4.1	13	14		
			125°C	3	4.4	13	14		
V _{OM-} Maximum negative peak output voltage swing	R _L = 10 kΩ		25°C	-3	-4.2	-12.5	-13.9	V	
			-55°C	-3	-4	-12.5	-13.8		
			125°C	-3	-4.3	-12.5	-14		
A _{VD} Large-signal differential voltage amplification§	R _L = 10 kΩ		25°C	4	12	5	14.3	V/mV	
			-55°C	3	7.1	4	10.4		
			125°C	3	12.9	4	15		
r _i Input resistance			25°C	10 ¹²		10 ¹²		Ω	
c _i Input capacitance			25°C	5		4		pF	
CMR _R Common-mode rejection ratio	V _{IC} = V _{ICRmin} , V _O = 0, R _S = 50 Ω		25°C	70	87	75	94	dB	
			-55°C	70	87	70	94		
			125°C	70	87	70	94		
k _{SVR} Supply-voltage rejection ratio (ΔV _{CC±} /ΔV _{IO})	V _O = 0, R _S = 50 Ω		25°C	75	96	75	96	dB	
			-55°C	75	96	75	95		
			125°C	75	96	75	96		
P _D Total power dissipation	V _O = 0, No load		25°C	1.9	2.5	6.5	8.4	mW	
			-55°C	1.1	2.5	4.7	8.4		
			125°C	1.8	2.5	5.8	8.4		

† Full range is -55°C to 125°C.

‡ Typical values are based on the input offset voltage shift observed through 168 hours of operating life test at T_A = 150°C extrapolated to T_A = 25°C using the Arrhenius equation and assuming an activation energy of 0.96 eV.

§ At V_{CC±} = ±5 V, V_O = ±2.3 V; at V_{CC±} = ±15 V, V_O = ±10 V.



TL03x, TL03xA, TL03xY ENHANCED-JFET LOW-POWER LOW-OFFSET OPERATIONAL AMPLIFIERS

SLOS180B – FEBRUARY 1997 – REVISED FEBRUARY 1999

TL031M and TL031AM electrical characteristics at specified free-air temperature (continued)

PARAMETER	TEST CONDITIONS	T _A	TL031M, TL031AM						UNIT
			V _{CC±} = ±5 V			V _{CC±} = ±15 V			
			MIN	TYP	MAX	MIN	TYP	MAX	
I _{CC} Supply current	V _O = 0, No load	25°C		192	250		217	280	μA
		-55°C		114	250		156	280	
		125°C		178	250		197	280	

TL031M and TL031AM operating characteristics at specified free-air temperature

PARAMETER	TEST CONDITIONS	T _A	TL031M, TL031AM						UNIT
			V _{CC±} = ±5 V			V _{CC±} = ±15 V			
			MIN	TYP	MAX	MIN	TYP	MAX	
SR+ Positive slew rate at unity gain†	R _L = 10 kΩ, C _L = 100 pF, See Figure 1	25°C		2		1.5	2.9	V/μs	
		-55°C		1.4		1	1.9		
		125°C		2.4		1	3.5		
SR- Negative slew rate at unity gain†		R _L = 10 kΩ, C _L = 100 pF, See Figure 1	25°C		3.9		1.5	5.1	V/μs
			-55°C		3.2		1	4.6	
			125°C		4.1		1	4.7	
t _r Rise time	V _{I(PP)} = ±10 mV, R _L = 10 kΩ, C _L = 100 pF, See Figures 1 and 2		25°C		138			132	ns
			-55°C		142			123	
			125°C		166			158	
t _f Fall time		V _{I(PP)} = ±10 mV, R _L = 10 kΩ, C _L = 100 pF, See Figure 1	25°C		138			132	ns
			-55°C		142			123	
			125°C		166			158	
Overshoot factor	V _{I(PP)} = ±10 mV, R _L = 10 kΩ, C _L = 100 pF, See Figures 1 and 2		25°C		11%			5%	
			-55°C		16%			6%	
			125°C		14%			8%	
V _n Equivalent input noise voltage		TL031M R _S = 20 Ω, See Figure 3	25°C	f = 10 Hz				61	nV/√Hz
				f = 1 kHz				41	
			25°C	f = 10 Hz				61	
	f = 1 kHz						41		
I _n Equivalent input noise current	f = 1 kHz	25°C		0.003			0.003	pA/√Hz	
B ₁ Unity-gain bandwidth	V _I = 10 mV, R _L = 10 kΩ, C _L = 25 pF, See Figure 4	25°C		1			1.1	MHz	
		-55°C		1			1.1		
		125°C		0.9			0.9		
φ _m Phase margin at unity gain	V _I = 10 mV, R _L = 10 kΩ, C _L = 25 pF, See Figure 4	25°C		61°			65°		
		-55°C		57°			64°		
		125°C		59°			62°		

† For V_{CC±} = ±5 V, V_{I(PP)} = ±1 V; for V_{CC±} = ±15 V, V_{I(PP)} = ±5 V.



TL03x, TL03xA, TL03xY
ENHANCED-JFET LOW-POWER LOW-OFFSET
OPERATIONAL AMPLIFIERS

SLOS180B – FEBRUARY 1997 – REVISED FEBRUARY 1999

TL031Y electrical characteristics, $T_A = 25^\circ\text{C}$

PARAMETER	TEST CONDITIONS	TL031Y						UNIT	
		$V_{CC\pm} = \pm 5\text{ V}$			$V_{CC\pm} = \pm 15\text{ V}$				
		MIN	TYP	MAX	MIN	TYP	MAX		
V_{IO} Input offset voltage	$V_O = 0,$ $R_S = 50\ \Omega$	$V_{IC} = 0,$	0.54			0.5			mV
α_{VIO} Temperature coefficient of input offset voltage			7.1			5.9			$\mu\text{V}/^\circ\text{C}$
I_{IO} Input offset current	$V_O = 0,$ See Figure 5	$V_{IC} = 0,$	1			1			pA
I_{IB} Input bias current			2			2			pA
V_{ICR} Common-mode input voltage range			-3.4 to 5.4			-13.4 to 15.4			V
V_{OM+} Maximum positive peak output voltage swing	$R_L = 10\ \text{k}\Omega$		4.3			14			V
V_{OM-} Maximum negative peak output voltage swing	$R_L = 10\ \text{k}\Omega$		-4.2			-13.9			V
A_{VD} Large-signal differential voltage amplification†	$R_L = 10\ \text{k}\Omega$		12			14.3			V/mV
r_i Input resistance			10^{12}			10^{12}			Ω
c_i Input capacitance			5			4			pF
CMRR Common-mode rejection ratio	$V_{IC} = V_{ICRmin},$ $R_S = 50\ \Omega$	$V_O = 0,$	87			94			dB
k_{SVR} Supply-voltage rejection ratio ($\Delta V_{CC\pm}/\Delta V_{IO}$)	$V_O = 0,$	$R_S = 50\ \Omega$	96			96			dB
P_D Total power dissipation	$V_O = 0,$	No load	1.9			6.5			mW
I_{CC} Supply current			192			217			μA

† At $V_{CC\pm} = \pm 5\text{ V}$, $V_O = \pm 2.3\text{ V}$; at $V_{CC\pm} = \pm 15\text{ V}$, $V_O = \pm 10\text{ V}$.

TL031Y operating characteristics, $T_A = 25^\circ\text{C}$

PARAMETER	TEST CONDITIONS	TL031Y						UNIT	
		$V_{CC\pm} = \pm 5\text{ V}$			$V_{CC\pm} = \pm 15\text{ V}$				
		MIN	TYP	MAX	MIN	TYP	MAX		
SR+ Positive slew rate at unity gain‡	$R_L = 10\ \text{k}\Omega,$ $C_L = 100\ \text{pF},$ See Figure 1	$R_L = 10\ \text{k}\Omega,$ $C_L = 100\ \text{pF},$ See Figure 1	2			2.9			V/ μs
SR- Negative slew rate at unity gain‡			3.9			5.1			V/ μs
t_r Rise time	$V_{I(PP)} = \pm 10\ \text{mV},$		138			132			ns
t_f Fall time	$R_L = 10\ \text{k}\Omega,$	$C_L = 100\ \text{pF},$	138			132			ns
Overshoot factor	See Figures 1 and 2		11%			5%			
V_n Equivalent input noise voltage	$R_S = 20\ \Omega,$ See Figure 3	$f = 10\ \text{Hz}$	61			61			nV/ $\sqrt{\text{Hz}}$
		$f = 1\ \text{kHz}$	41			41			
I_n Equivalent input noise current	$f = 1\ \text{kHz}$		0.003			0.003			pA/ $\sqrt{\text{Hz}}$
B_1 Unity-gain bandwidth	$V_I = 10\ \text{mV},$ $C_L = 25\ \text{pF},$	$R_L = 10\ \text{k}\Omega,$ See Figure 4	1			1.1			MHz
ϕ_m Phase margin at unity gain	$V_I = 10\ \text{mV},$ $C_L = 25\ \text{pF},$	$R_L = 10\ \text{k}\Omega,$ See Figure 4	61°			65°			

‡ For $V_{CC\pm} = \pm 5\text{ V}$, $V_{I(PP)} = \pm 1\text{ V}$; for $V_{CC\pm} = \pm 15\text{ V}$, $V_{I(PP)} = \pm 5\text{ V}$.



TL03x, TL03xA, TL03xY ENHANCED-JFET LOW-POWER LOW-OFFSET OPERATIONAL AMPLIFIERS

SLOS180B – FEBRUARY 1997 – REVISED FEBRUARY 1999

TL032C and TL032AC electrical characteristics at specified free-air temperature

PARAMETER	TEST CONDITIONS	T _A	TL032C, TL032AC						UNIT
			V _{CC±} = ±5 V			V _{CC±} = ±15 V			
			MIN	TYP	MAX	MIN	TYP	MAX	
V _{IO} Input offset voltage	V _O = 0, V _{IC} = 0, R _S = 50 Ω	TL032C	25°C	0.69	3.5	0.57	1.5	mV	
			Full range†	4.5		2.5			
		TL032AC	25°C	0.53	2.8	0.39	0.8		
			Full range†	3.8		1.8			
α _{VIO} Temperature coefficient of input offset voltage	V _O = 0, V _{IC} = 0, R _S = 50 Ω	TL032C	25°C to 70°C	11.5		10.8		μV/°C	
		TL032AC	25°C to 70°C	11.5		10.8 25			
Input offset voltage long-term drift‡		25°C	0.04		0.04		μV/mo		
I _{IO} Input offset current	V _O = 0, See Figure 5	V _{IC} = 0,	25°C	1	100	1	100	pA	
			70°C	9	200	12	200		
I _{IB} Input bias current	V _O = 0, See Figure 5	V _{IC} = 0,	25°C	2	200	2	200	pA	
			70°C	50	400	80	400		
V _{ICR} Common-mode input voltage range			25°C	-1.5 to 4	-3.4 to 5.4	-11.5 to 14	-13.4 to 15.4	V	
			Full range†	-1.5 to 4		-11.5 to 14			
V _{OM+} Maximum positive peak output voltage swing	R _L = 10 kΩ		25°C	3	4.3	13	14	V	
			0°C	3	4.2	13	14		
			70°C	3	4.3	13	14		
V _{OM-} Maximum negative peak output voltage swing	R _L = 10 kΩ		25°C	-3	-4.2	-12.5	-13.9	V	
			0°C	-3	-4.1	-12.5	-13.9		
			70°C	-3	-4.2	-12.5	-14		
A _{VD} Large-signal differential voltage amplification§	R _L = 10 kΩ		25°C	4	12	5	14.3	V/mV	
			0°C	3	11.1	4	13.5		
			70°C	4	13.3	5	15.2		
r _i Input resistance		25°C	10 ¹²		10 ¹²		Ω		
c _i Input capacitance		25°C	5		14		pF		
CMRR Common-mode rejection ratio	V _{IC} = V _{ICRmin} , V _O = 0, R _S = 50 Ω		25°C	70	87	75	94	dB	
			0°C	70	87	75	94		
			70°C	70	87	75	94		
k _{SVR} Supply-voltage rejection ratio (ΔV _{CC±} /ΔV _{IO})	V _{CC±} = ±5 V to ±15 V, V _O = 0, R _S = 50 Ω		25°C	75	96	75	96	dB	
			0°C	75	96	75	96		
			70°C	75	96	75	96		

† Full range is 0°C to 70°C.

‡ Typical values are based on the input offset voltage shift observed through 168 hours of operating life test at T_A = 150°C extrapolated to T_A = 25°C using the Arrhenius equation and assuming an activation energy of 0.96 eV.

§ At V_{CC±} = ±5 V, V_O = 2.3 V; at V_{CC±} = ±15 V, V_O = ±10 V.



TL03x, TL03xA, TL03xY
ENHANCED-JFET LOW-POWER LOW-OFFSET
OPERATIONAL AMPLIFIERS

SLOS180B – FEBRUARY 1997 – REVISED FEBRUARY 1999

TL032C and TL032AC electrical characteristics at specified free-air temperature (continued)

PARAMETER	TEST CONDITIONS	T _A	TL032C, TL032AC						UNIT
			V _{CC±} = ±5 V			V _{CC±} = ±15 V			
			MIN	TYP	MAX	MIN	TYP	MAX	
P _D	Total power dissipation (two amplifiers)	V _O = 0, No load	25°C	3.8	5	13	17	mW	
			0°C	3.7	5	12.7	17		
			70°C	3.8	5	12.6	17		
I _{CC}	Supply current (two amplifiers)	V _O = 0, No load	0°C	368	500	422	560	μA	
			70°C	378	500	420	560		
V _{O1} /V _{O2}	Crosstalk attenuation	A _{VD} = 100 dB	25°C	120		120		dB	

TL032C and TL032AC operating characteristics at specified free-air temperature

PARAMETER	TEST CONDITIONS	T _A	TL032C, TL032AC						UNIT
			V _{CC±} = ±5 V			V _{CC±} = ±15 V			
			MIN	TYP	MAX	MIN	TYP	MAX	
SR ₊	Positive slew rate at unity gain†	R _L = 10 kΩ, C _L = 100 pF, See Figure 1	25°C	12		1.5	2.9	V/μs	
			0°C	1.8		1	2.6		
			70°C	2.2		1.5	3.2		
SR ₋	Negative slew rate at unity gain†	R _L = 10 kΩ, C _L = 100 pF, See Figure 1	25°C	3.9		1.5	5.1	V/μs	
			0°C	3.7		1.5	5		
			70°C	4		1.5	5		
t _r	Rise time	V _{I(PP)} = ±10 V, R _L = 10 kΩ, C _L = 100 pF, See Figures 1 and 2	25°C	138		132	ns		
			0°C	134		127			
			70°C	150		142			
t _f	Fall time	V _{I(PP)} = ±10 V, R _L = 10 kΩ, C _L = 100 pF, See Figures 1 and 2	25°C	138		132	ns		
			0°C	134		127			
			70°C	150		142			
Overshoot factor			25°C	11%		5%			
			0°C	10%		4%			
			70°C	12%		6%			
V _n	Equivalent input noise voltage	TL032C	R _S = 20 Ω, See Figure 3	f = 10 Hz	25°C	49	49	nV/√Hz	
				f = 1 kHz	41	41			
		TL032AC	f = 10 Hz	25°C	49	49			
			f = 1 kHz	41	41	60			
I _n	Equivalent input noise current	f = 1 kHz	25°C	0.003	0.003	pA/√Hz			
B ₁	Unity-gain bandwidth	V _I = 10 mV, C _L = 25 pF, R _L = 10 kΩ, See Figure 4	25°C	1	1.1	MHz			
			0°C	1	1.1				
			70°C	1	1				
φ _m	Phase margin at unity gain	V _I = 10 mV, C _L = 25 pF, R _L = 10 kΩ, See Figure 4	25°C	61°	65°				
			0°C	61°	65°				
			70°C	60°	64°				

† For V_{CC±} = ±5 V, V_{I(PP)} = ±1 V; for V_{CC±} = ±15 V, V_{I(PP)} = ±5 V.



TL03x, TL03xA, TL03xY ENHANCED-JFET LOW-POWER LOW-OFFSET OPERATIONAL AMPLIFIERS

SLOS180B – FEBRUARY 1997 – REVISED FEBRUARY 1999

TL032I and TL032AI electrical characteristics at specified free-air temperature

PARAMETER	TEST CONDITIONS		T _A	TL032I, TL032AI						UNIT
				V _{CC±} = ±5 V			V _{CC±} = ±15 V			
				MIN	TYP	MAX	MIN	TYP	MAX	
V _{IO} Input offset voltage		TL032I	25°C	0.69	3.5		0.57	1.5	mV	
			Full range†		5.3		3.3			
		TL032AI	25°C	0.53	2.8		0.39	0.8		
			Full range†		4.6		2.6			
α _{VIO} Temperature coefficient of input offset voltage	V _O = 0, V _{IC} = 0, R _S = 50 Ω	TL032I	25°C to 85°C	11.4			10.8		μV/°C	
		TL032AI	25°C to 85°C	11.4			10.8	25		
Input offset voltage long-term drift‡			25°C	0.04			0.04		μV/mo	
I _{IO} Input offset current	V _O = 0, See Figure 5	V _{IC} = 0,	25°C	1	100		1	100	pA	
			85°C	0.02	0.45		0.02	0.45	nA	
I _{IB} Input bias current	V _O = 0, See Figure 5	V _{IC} = 0,	25°C	2	200		2	200	pA	
			85°C	0.2	0.9		0.3	0.9	nA	
V _{ICR} Common-mode input voltage range			25°C	-1.5 to 4	-3.4 to 5.4		-11.5 to 14	-13.4 to 15.4	V	
			Full range†	-1.5 to 4			-11.5 to 14			
V _{OM+} Maximum positive peak output voltage swing	R _L = 10 kΩ		25°C	3	4.3		13	14	V	
			-40°C	3	4.2		13	14		
			85°C	3	4.4		13	14		
V _{OM-} Maximum negative peak output voltage swing	R _L = 10 kΩ		25°C	-3	-4.2		-12.5	-13.9	V	
			-40°C	-3	-4.1		-12.5	-13.8		
			85°C	-3	-4.2		-12.5	-14		
A _{VD} Large-signal differential voltage amplification§	R _L = 10 kΩ		-40°C	3	8.4		4	11.6	V/mV	
			85°C	4	13.5		5	15.3		
r _i Input resistance			25°C	10 ¹²			10 ¹²		Ω	
c _i Input capacitance			25°C	5			4		pF	
CMRR Common-mode rejection ratio	V _{IC} = V _{ICRmin} , V _O = 0, R _S = 50 Ω		25°C	70	87		75	94	dB	
			-40°C	70	87		75	94		
			85°C	70	87		75	94		
k _{SVR} Supply-voltage rejection ratio (ΔV _{CC±} /ΔV _{IO})	V _{CC±} = ±5 V to ±15 V, V _O = 0, R _S = 50 Ω		25°C	75	96		75	96	dB	
			-40°C	75	96		75	96		
			85°C	75	96		75	96		

† Full range is -40°C to 85°C.

‡ Typical values are based on the input offset voltage shift observed through 168 hours of operating life test at T_A = 150°C extrapolated to T_A = 25°C using the Arrhenius equation and assuming an activation energy of 0.96 eV.

§ At V_{CC±} = ±5 V, V_O = 2.3 V; at V_{CC±} = ±15 V, V_O = ±10 V.



TL03x, TL03xA, TL03xY
ENHANCED-JFET LOW-POWER LOW-OFFSET
OPERATIONAL AMPLIFIERS

SLOS180B – FEBRUARY 1997 – REVISED FEBRUARY 1999

TL032I and TL032AI electrical characteristics at specified free-air temperature (continued)

PARAMETER	TEST CONDITIONS	T _A	TL032I, TL032AI						UNIT	
			V _{CC±} = ±5 V			V _{CC±} = ±15 V				
			MIN	TYP	MAX	MIN	TYP	MAX		
P _D	Total power dissipation (two amplifiers)	V _O = 0, No load	25°C	3.8		5	13		mW	
			-40°C	2.9		5	10.9			
			85°C	3.7		5	12.4			
I _{CC}	Supply current (two amplifiers)	V _O = 0, No load	25°C	384	500		434	560		μA
			-40°C	288	500		362	560		
			85°C	372	500		414	560		
V _{O1} /V _{O2}	Crosstalk attenuation	A _V D = 100 dB	25°C	120			120			dB

TL032I and TL032AI operating characteristics at specified free-air temperature

PARAMETER	TEST CONDITIONS	T _A	TL032I, TL032AI						UNIT		
			V _{CC±} = ±5 V			V _{CC±} = ±15 V					
			MIN	TYP	MAX	MIN	TYP	MAX			
SR ₊	Positive slew rate at unity gain†	R _L = 10 kΩ, C _L = 100 pF	25°C	2			1.5	2.9		V/μs	
			-40°C	1.6			1	2.1			
			85°C	2.3			1.5	3.3			
SR ₋	Negative slew rate at unity gain†	R _L = 10 kΩ, C _L = 100 pF	25°C	3.9			1.5	5.1		V/μs	
			-40°C	3.3			1.5	4.8			
			85°C	4.1			1.5	4.9			
t _r	Rise time	V _I (PP) = ±10 V, R _L = 10 kΩ, C _L = 100 pF, See Figures 1 and 2	25°C	138			132			ns	
			-40°C	132			123				
			85°C	154			146				
t _f	Fall time	V _I (PP) = ±10 V, R _L = 10 kΩ, C _L = 100 pF, See Figure 1	25°C	138			132			ns	
			-40°C	132			123				
			85°C	154			146				
Overshoot factor	Overshoot factor	V _I (PP) = ±10 V, R _L = 10 kΩ, C _L = 100 pF, See Figures 1 and 2	25°C	11%			5%				
			-40°C	12%			5%				
			85°C	13%			7%				
V _n	Equivalent input noise voltage	TL032I	R _S = 20 Ω, See Figure 3	f = 10 Hz	25°C			49			nV/√Hz
				f = 1 kHz	41			41			
		TL032AI		f = 10 Hz	25°C			49			
				f = 1 kHz	41			41 60			
I _n	Equivalent input noise current	f = 1 kHz	25°C	0.003			0.003			pA/√Hz	
B ₁	Unity-gain bandwidth	V _I = 10 mV, C _L = 25 pF, R _L = 10 kΩ, See Figure 4	25°C	1			1.1			MHz	
			-40°C	1			1.1				
			85°C	0.9			1				
φ _m	Phase margin at unity gain	V _I = 10 mV, C _L = 25 pF, R _L = 10 kΩ, See Figure 4	25°C	61°			65°				
			-40°C	61°			65°				
			85°C	60°			64°				

† For V_{CC±} = ±5 V, V_I(PP) = ±1 V; for V_{CC±} = ±15 V, V_I(PP) = ±5 V.



TL03x, TL03xA, TL03xY ENHANCED-JFET LOW-POWER LOW-OFFSET OPERATIONAL AMPLIFIERS

SLOS180B – FEBRUARY 1997 – REVISED FEBRUARY 1999

TL032M and TL032AM electrical characteristics at specified free-air temperature

PARAMETER	TEST CONDITIONS	T _A	TL032M, TL032AM						UNIT
			V _{CC±} = ±5 V			V _{CC±} = ±15 V			
			MIN	TYP	MAX	MIN	TYP	MAX	
V _{IO} Input offset voltage	V _O = 0, V _{IC} = 0, R _S = 50 Ω	TL032M	25°C	0.69	3.5	0.57	1.5	mV	
			Full range†	6.5			4.5		
		TL032AM	25°C	0.53	2.8	0.39	0.8		
			Full range†	5.8			3.8		
α _{VIO} Temperature coefficient of input offset voltage	V _O = 0, V _{IC} = 0, R _S = 50 Ω	TL032M	25°C to 125°C	9.7			9.7	μV/°C	
		TL032AM	25°C to 125°C	9.7			9.7		
Input offset voltage long-term drift‡		25°C	0.04			0.04	μV/mo		
I _{IO} Input offset current	V _O = 0, See Figure 5	V _{IC} = 0,	25°C	1	100	1	100	pA	
			125°C	0.2	10	0.2	10	nA	
I _{IB} Input bias current	V _O = 0, See Figure 5	V _{IC} = 0,	25°C	2	200	2	200	pA	
			125°C	7	20	8	20	nA	
V _{ICR} Common-mode input voltage range			25°C	-1.5 to 4	-3.4 to 5.4	-11.5 to 14	-13.4 to 15.4	V	
			Full range†	-1.5 to 4		-11.5 to 14			
V _{OM+} Maximum positive peak output voltage swing	R _L = 10 kΩ		25°C	3	4.3	13	14	V	
			-55°C	3	4.1	13	14		
			125°C	3	4.4	13	14		
V _{OM-} Maximum negative peak output voltage swing	R _L = 10 kΩ		25°C	-3	-4.2	-12.5	-13.9	V	
			-55°C	-3	-4	-12.5	-13.8		
			125°C	-3	-4.3	-12.5	-14		
A _{VD} Large-signal differential voltage amplification§	R _L = 10 kΩ		25°C	4	12	5	14.3	V/mV	
			-55°C	3	7.1	4	10.4		
			125°C	3	12.9	4	15		
r _i Input resistance		25°C	10 ¹²			10 ¹²	Ω		
c _i Input capacitance		25°C	5			4	pF		
CMRR Common-mode rejection ratio	V _{IC} = V _{ICRmin} , V _O = 0, R _S = 50 Ω		25°C	70	87	75	94	dB	
			-55°C	70	87	70	94		
			125°C	70	87	70	94		
k _{SVR} Supply-voltage rejection ratio (ΔV _{CC±} /ΔV _{IO})	V _{CC±} = ±5 V to ±15 V, V _O = 0, R _S = 50 Ω		25°C	75	96	75	96	dB	
			-55°C	75	95	75	95		
			125°C	75	96	75	96		

† Full range is -55°C to 125°C.

‡ Typical values are based on the input offset voltage shift observed through 168 hours of operating life test at T_A = 150°C extrapolated to T_A = 25°C using the Arrhenius equation and assuming an activation energy of 0.96 eV.

§ At V_{CC±} = ±5 V, V_O = 2.3 V; at V_{CC±} = ±15 V, V_O = ±10 V.



TL03x, TL03xA, TL03xY
ENHANCED-JFET LOW-POWER LOW-OFFSET
OPERATIONAL AMPLIFIERS

SLOS180B – FEBRUARY 1997 – REVISED FEBRUARY 1999

TL032M and TL032AM electrical characteristics at specified free-air temperature (continued)

PARAMETER	TEST CONDITIONS	T _A	TL032M, TL032AM						UNIT
			V _{CC±} = ±5 V			V _{CC±} = ±15 V			
			MIN	TYP	MAX	MIN	TYP	MAX	
P _D	Total power dissipation (two amplifiers)	V _O = 0, No load	25°C	3.8	5	13	17	mW	
			-55°C	2.3	5	9.4	17		
			125°C	3.6	5	11.8	17		
I _{CC}	Supply current (two amplifiers)	V _O = 0, No load	25°C	384	500	434	560	μA	
			-55°C	228	500	312	560		
			125°C	356	500	394	560		
V _{O1} /V _{O2}	Crosstalk attenuation	A _{VD} = 100 dB	25°C	120		120		dB	

TL032M and TL032AM operating characteristics at specified free-air temperature

PARAMETER	TEST CONDITIONS	T _A	TL032M, TL032AM						UNIT
			V _{CC±} = ±5 V			V _{CC±} = ±15 V			
			MIN	TYP	MAX	MIN	TYP	MAX	
SR ₊	Positive slew rate at unity gain†	R _L = 10 kΩ, C _L = 100 pF, See and Figure 1	25°C	2		1.5	2.9	V/μs	
			-55°C	1.4		1	1.9		
			125°C	2.4		1	3.5		
SR ₋	Negative slew rate at unity gain†	R _L = 10 kΩ, C _L = 100 pF, See and Figure 1	25°C	3.9		1.5	5.1	V/μs	
			-55°C	3.2		1	4.6		
			125°C	4.1		1	4.7		
t _r	Rise time	V _{I(PP)} = ±10 V, R _L = 10 kΩ, C _L = 100 pF, See Figures 1 and 2	25°C	138		132	ns		
			-55°C	142		123			
			125°C	166		58			
t _f	Fall time	V _{I(PP)} = ±10 V, R _L = 10 kΩ, C _L = 100 pF, See Figure 1	25°C	138		132	ns		
			-55°C	142		123			
			125°C	166		158			
Overshoot factor	Overshoot factor	V _{I(PP)} = ±10 V, R _L = 10 kΩ, C _L = 100 pF, See Figures 1 and 2	25°C	11%		5%			
			-55°C	16%		6%			
			125°C	14%		8%			
V _n	Equivalent input noise voltage	TL032M	f = 10 Hz	49		49	nV/√Hz		
			f = 1 kHz	41		41			
		TL032AM	f = 10 Hz	49		49			
			f = 1 kHz	41		41			
I _n	Equivalent input noise current	f = 1 kHz	25°C	0.003		0.003	pA/√Hz		
B1	Unity-gain bandwidth	V _I = 10 mV, C _L = 25 pF, R _L = 10 kΩ, See Figure 4	25°C	1		1.1	MHz		
			-55°C	1		1.1			
			125°C	0.9		0.9			
φ _m	Phase margin at unity gain	V _I = 10 mV, C _L = 25 pF, R _L = 10 kΩ, See Figure 4	25°C	61°		65°			
			-55°C	57°		64°			
			125°C	59°		62°			

† For V_{CC±} = ±5 V, V_{I(PP)} = ±1 V; for V_{CC±} = ±15 V, V_{I(PP)} = ±5 V.



TL03x, TL03xA, TL03xY

ENHANCED-JFET LOW-POWER LOW-OFFSET OPERATIONAL AMPLIFIERS

SLOS180B – FEBRUARY 1997 – REVISED FEBRUARY 1999

TL032Y electrical characteristics, $T_A = 25^\circ\text{C}$

PARAMETER	TEST CONDITIONS	TL032Y						UNIT		
		$V_{CC\pm} = \pm 5\text{ V}$			$V_{CC\pm} = \pm 15\text{ V}$					
		MIN	TYP	MAX	MIN	TYP	MAX			
V_{IO}	Input offset voltage	$V_O = 0, R_S = 50\ \Omega$		$V_{IC} = 0,$		0.69		0.57		mV
αV_{IO}	Temperature coefficient of input offset voltage					11.5		10.8		$\mu\text{V}/^\circ\text{C}$
I_{IO}	Input offset current	$V_O = 0, R_S = 50\ \Omega$		$V_{IC} = 0,$ See Figure 5		1		1		pA
I_{IB}	Input bias current	$V_O = 0, R_S = 50\ \Omega$		$V_{IC} = 0,$ See Figure 5		2		2		pA
V_{ICR}	Common-mode input voltage range			-3.4 to 5.4		-13.4 to 15.4				V
V_{OM+}	Maximum positive peak output voltage swing	$R_L = 10\ \text{k}\Omega$				4.3		14		V
V_{OM-}	Maximum negative peak output voltage swing	$R_L = 10\ \text{k}\Omega$				-4.2		-13.9		V
A_{VD}	Large-signal differential voltage amplification†	$R_L = 10\ \text{k}\Omega$				12		14.3		V/mV
r_i	Input resistance					10^{12}		10^{12}		Ω
c_i	Input capacitance					5		14		pF
CMRR	Common-mode rejection ratio	$V_{IC} = V_{ICRmin}, V_O = 0, R_S = 50\ \Omega$				87		94		dB
k_{SVR}	Supply-voltage rejection ratio ($\Delta V_{CC\pm}/\Delta V_{IO}$)	$V_{CC\pm} = \pm 5\text{ V to } \pm 15\text{ V}, V_O = 0, R_S = 50\ \Omega$				96		96		dB
P_D	Total power dissipation (two amplifiers)	$V_O = 0,$		No load		3.8		13		mW
V_{O1}/V_{O2}	Crosstalk attenuation	$A_{VD} = 100\ \text{dB}$				120		120		dB

† At $V_{CC\pm} = \pm 5\text{ V}, V_O = 2.3\text{ V}$; at $V_{CC\pm} = \pm 15\text{ V}, V_O = \pm 10\text{ V}$.

TL032Y operating characteristics, $T_A = 25^\circ\text{C}$

PARAMETER	TEST CONDITIONS	TL032Y						UNIT	
		$V_{CC\pm} = \pm 5\text{ V}$			$V_{CC\pm} = \pm 15\text{ V}$				
		MIN	TYP	MAX	MIN	TYP	MAX		
SR+	Positive slew rate at unity gain†	$R_L = 10\ \text{k}\Omega, C_L = 100\ \text{pF},$ See Figure 1 and Note 8		12		2.9		V/ μs	
SR-	Negative slew rate at unity gain†			3.9		5.1		V/ μs	
t_r	Rise time	$V_{I(PP)} = \pm 10\text{ V},$		138		132		ns	
t_f	Fall time	$R_L = 10\ \text{k}\Omega, C_L = 100\ \text{pF},$		138		132		ns	
	Overshoot factor	See Figures 1 and 2		11%		5%			
V_n	Equivalent input noise voltage	$R_S = 20\ \Omega,$ See Figure 3		$f = 10\ \text{Hz}$		49		nV/ $\sqrt{\text{Hz}}$	
				$f = 1\ \text{kHz}$		41			
I_n	Equivalent input noise current	$f = 1\ \text{kHz}$		0.003		0.003		pA/ $\sqrt{\text{Hz}}$	
B_1	Unity-gain bandwidth	$V_I = 10\ \text{mV}, C_L = 25\ \text{pF},$ See Figure 4		$R_L = 10\ \text{k}\Omega,$ See Figure 4		1		1.1	MHz
ϕ_m	Phase margin at unity gain	$V_I = 10\ \text{mV}, C_L = 25\ \text{pF},$ See Figure 4		$R_L = 10\ \text{k}\Omega,$ See Figure 4		61°		65°	

† For $V_{CC\pm} = \pm 5\text{ V}, V_{I(PP)} = \pm 1\text{ V}$; for $V_{CC\pm} = \pm 15\text{ V}, V_{I(PP)} = \pm 5\text{ V}$.



TL03x, TL03xA, TL03xY
ENHANCED-JFET LOW-POWER LOW-OFFSET
OPERATIONAL AMPLIFIERS

SLOS180B – FEBRUARY 1997 – REVISED FEBRUARY 1999

TL034C and TL034AC electrical characteristics at specified free-air temperature

PARAMETER	TEST CONDITIONS	T _A	TL034C, TL034AC						UNIT
			V _{CC±} = ±5 V			V _{CC±} = ±15 V			
			MIN	TYP	MAX	MIN	TYP	MAX	
V _{IO} Input offset voltage	V _O = 0, V _{IC} = 0, R _S = 50 Ω	TL034C	25°C	0.91	6	0.79	4	mV	
			Full range†	8.2			6.2		
		TL034AC	25°C	0.7	3.5	0.58	1.5		
			Full range†	5.7			3.7		
αV _{IO} Temperature coefficient of input offset voltage		TL034C	25°C to 70°C	11.6		12		μV/°C	
		TL034AC	25°C to 70°C	11.6		12	25		
Input offset voltage long-term drift‡		25°C	0.04		0.04		μV/mo		
I _{IO} Input offset current	V _O = 0, V _{IC} = 0, See Figure 5	25°C	1	100	1	100	pA		
		70°C	9	200	12	200			
I _{IB} Input bias current	V _O = 0, V _{IC} = 0, See Figure 5	25°C	2	200	2	200	pA		
		70°C	50	400	80	400			
V _{ICR} Common-mode input voltage range		25°C	-1.5 to 4	-3.4 to 5.4	-11.5 to 14	-13.4 to 15.4	V		
		Full range†	-1.5 to 4		-11.5 to 14				
V _{OM+} Maximum positive peak output voltage swing	R _L = 10 kΩ	25°C	3	4.3	13	14	V		
		0°C	3	4.2	13	14			
		70°C	3	4.3	13	14			
V _{OM-} Maximum negative peak output voltage swing	R _L = 10 kΩ	25°C	-3	-4.2	-12.5	-13.9	V		
		0°C	-3	-4.1	-12.5	-13.9			
		70°C	-3	-4.2	-12.5	-14			
A _{VD} Large-signal differential voltage amplification§	R _L = 10 kΩ	25°C	4	12	5	14.3	V/mV		
		0°C	3	11.1	4	13.5			
		70°C	4	13.3	5	15.2			
r _i Input resistance		25°C	10 ¹²			10 ¹²	Ω		
c _i Input capacitance		25°C	5		14		pF		
CMRR Common-mode rejection ratio	V _{IC} = V _{ICRmin} , V _O = 0, R _S = 50 Ω	25°C	70	87	75	94	dB		
		0°C	70	87	75	94			
		70°C	70	87	75	94			
k _{SVR} Supply-voltage rejection ratio (ΔV _{CC±} /ΔV _{IO})	V _O = 0, R _S = 50 Ω	25°C	75	96	75	96	dB		
		0°C	75	96	75	96			
		70°C	75	96	75	96			

† Full range is 0°C to 70°C.

‡ Typical values are based on the input offset voltage shift observed through 168 hours of operating life test at T_A = 150°C extrapolated to T_A = 25°C using the Arrhenius equation and assuming an activation energy of 0.96 eV.

§ At V_{CC±} = ±5 V, V_O = ±2.3 V; at V_{CC±} = ±15 V, V_O = ±10 V.



TL03x, TL03xA, TL03xY ENHANCED-JFET LOW-POWER LOW-OFFSET OPERATIONAL AMPLIFIERS

SLOS180B – FEBRUARY 1997 – REVISED FEBRUARY 1999

TL034C and TL034AC electrical characteristics at specified free-air temperature (continued)

PARAMETER	TEST CONDITIONS	T _A	TL034C, TL034AC						UNIT
			V _{CC±} = ±5 V			V _{CC±} = ±15 V			
			MIN	TYP	MAX	MIN	TYP	MAX	
P _D Total power dissipation (two amplifiers)	V _O = 0, No load	25°C	7.7	10		26	34	mW	
		0°C	7.4	10		25.3	34		
		70°C	7.6	10		25.2	34		
I _{CC} Supply current (four amplifiers)	V _O = 0, No load	25°C	0.77	1		0.87	1.12	mA	
		0°C	0.74	1		0.85	1.12		
		70°C	0.76	1		0.84	1.12		
V _{O1} /V _{O2} Crosstalk attenuation	A _{VD} = 100	25°C	120		120		dB		

TL034C and TL034AC operating characteristics at specified free-air temperature

PARAMETER	TEST CONDITIONS	T _A	TL034C, TL034AC						UNIT
			V _{CC±} = ±5 V			V _{CC±} = ±15 V			
			MIN	TYP	MAX	MIN	TYP	MAX	
SR ₊ Positive slew rate at unity gain†	R _L = 10 kΩ, C _L = 100 pF, See Figure 1	25°C	2			1.5 2.9			V/μs
		0°C	1.8			1 2.6			
		70°C	2.2			1.5 3.2			
SR ₋ Negative slew rate at unity gain†		25°C	3.9			1.5 5.1			V/μs
		0°C	3.7			1.5 5			
		70°C	4			1.5 5			
t _r Rise time	V _I (PP) = ±10 V, R _L = 10 kΩ, C _L = 100 pF, See Figures 1 and 2	25°C	138			132			ns
		0°C	134			127			
		70°C	150			142			
t _f Fall time	V _I (PP) = ±10 V, R _L = 10 kΩ, C _L = 100 pF, See Figure 1	25°C	138			132			ns
		0°C	134			127			
		70°C	150			142			
Overshoot factor	V _I (PP) = ±10 V, R _L = 10 kΩ, C _L = 100 pF, See Figures 1 and 2	25°C	11%			5%			
		0°C	10%			4%			
		70°C	12%			6%			
V _n Equivalent input noise voltage	TL034C RS = 20 Ω, See Figure 3	25°C	f = 10 Hz			83			nV/√Hz
			f = 1 kHz			43			
		25°C	f = 10 Hz			83			
			f = 1 kHz			43 60			
I _n Equivalent input noise current	f = 1 kHz	25°C	0.003			0.003			pA/√Hz
B ₁ Unity-gain bandwidth	V _I = 10 mV, R _L = 10 kΩ, C _L = 25 pF, See Figure 4	25°C	1			1.1			MHz
		0°C	1			1.1			
		70°C	1			1			
φ _m Phase margin at unity gain	V _I = 10 mV, R _L = 10 kΩ, C _L = 25 pF, See Figure 4	25°C	61°			65°			
		0°C	61°			65°			
		70°C	60°			64°			

† For V_{CC±} = ±5 V, V_I(PP) = ±1 V; for V_{CC±} = ±15 V, V_I(PP) = ±5 V.



TL03x, TL03xA, TL03xY
ENHANCED-JFET LOW-POWER LOW-OFFSET
OPERATIONAL AMPLIFIERS

SLOS180B – FEBRUARY 1997 – REVISED FEBRUARY 1999

TL034I and TL034AI electrical characteristics at specified free-air temperature

PARAMETER	TEST CONDITIONS		T _A	TL034I, TL034AI						UNIT
				V _{CC±} = ±5 V			V _{CC±} = ±15 V			
				MIN	TYP	MAX	MIN	TYP	MAX	
V _{IO} Input offset voltage	V _O = 0, V _{IC} = 0, R _S = 50 Ω	TL034I	25°C	0.91	3.6	0.79	4	mV		
			Full range†	9.3		7.3				
		TL034AI	25°C	0.7	3.5	0.58	1.5			
			Full range†	6.8		4.8				
αV _{IO} Temperature coefficient of input offset voltage		TL034I	25°C to 85°C	11.5		11.6		μV/°C		
		TL034AI	25°C to 85°C	11.5		11.6 25				
Input offset voltage long-term drift‡			25°C	0.04		0.04		μV/mo		
I _{IO} Input offset current	V _O = 0, V _{IC} = 0, See Figure 5		25°C	1	100	1	100	pA		
			85°C	0.02	0.45	0.02	0.45	nA		
I _{IB} Input bias current	V _O = 0, V _{IC} = 0, See Figure 5		25°C	2	200	2	200	pA		
			85°C	0.2	0.9	0.3	0.9	nA		
V _{ICR} Common-mode input voltage range			25°C	-1.5 to 4	-3.4 to 5.4	-11.5 to 14	-13.4 to 15.4	V		
			Full range†	-1.5 to 4		-11.5 to 14				
V _{OM+} Maximum positive peak output voltage swing	R _L = 10 kΩ		25°C	3	4.3	13	14	V		
			-40°C	3	4.1	13	14			
			85°C	3	4.4	13	14			
V _{OM-} Maximum negative peak output voltage swing	R _L = 10 kΩ		25°C	-3	-4.2	-12.5	-13.9	V		
			-40°C	-3	-4.1	-12.5	-13.8			
			85°C	-3	-4.2	-12.5	-14			
A _{VD} Large-signal differential voltage amplification§	R _L = 10 kΩ		-40°C	4	12	5	14.3	V/mV		
			85°C	3	8.4	4	11.6			
r _i Input resistance			25°C	10 ¹²		10 ¹²		Ω		
c _i Input capacitance			25°C	5		4		pF		
CMRR Common-mode rejection ratio	V _{IC} = V _{ICRmin} , V _O = 0, R _S = 50 Ω		25°C	70	87	75	94	dB		
			-40°C	70	87	75	94			
			85°C	70	87	75	94			
k _{SVR} Supply-voltage rejection ratio (ΔV _{CC±} /ΔV _{IO})	V _O = 0, R _S = 50 Ω		25°C	75	96	75	96	dB		
			-40°C	75	96	75	96			
			85°C	75	96	75	96			

† Full range is -40°C to 85°C.

‡ Typical values are based on the input offset voltage shift observed through 168 hours of operating life test at T_A = 150°C extrapolated to T_A = 25°C using the Arrhenius equation and assuming an activation energy of 0.96 eV.

§ At V_{CC±} = ±5 V, V_O = ±2.3 V; at V_{CC±} = ±15 V, V_O = ±10 V.



TL03x, TL03xA, TL03xY ENHANCED-JFET LOW-POWER LOW-OFFSET OPERATIONAL AMPLIFIERS

SLOS180B – FEBRUARY 1997 – REVISED FEBRUARY 1999

TL034I and TL034AI electrical characteristics at specified free-air temperature (continued)

PARAMETER	TEST CONDITIONS	T _A	TL034I, TL034AI						UNIT
			V _{CC±} = ±5 V			V _{CC±} = ±15 V			
			MIN	TYP	MAX	MIN	TYP	MAX	
P _D	Total power dissipation (four amplifiers) V _O = 0, No load	25°C	7.7	10		26	34	mW	
		-40°C	5.8	10		21.7	34		
		85°C	7.4	10		24.8	34		
I _{CC}	Supply current (four amplifiers) V _O = 0, No load	25°C	0.77	1		0.87	1.12	mA	
		-40°C	0.58	1		0.72	1.12		
		85°C	0.74	1		0.83	1.12		
V _{O1} /V _{O2}	Crosstalk attenuation	A _{VD} = 100	25°C	120		120		dB	

TL034I and TL034AI operating characteristics

PARAMETER	TEST CONDITIONS	T _A	TL034I, TL034AI						UNIT
			V _{CC±} = ±5 V			V _{CC±} = ±15 V			
			MIN	TYP	MAX	MIN	TYP	MAX	
SR ₊	Positive slew rate at unity gain† R _L = 10 kΩ, C _L = 100 pF, See Figure 1	25°C		2		1.5	2.9	V/μs	
		-40°C		1.6		1	2.1		
		85°C		2.3		1.5	3.3		
SR ₋	Negative slew rate at unity gain†	25°C		3.9		1.5	5.1	V/μs	
		-40°C		3.3		1.5	4.8		
		85°C		4.1		1.5	4.9		
t _r	Rise time	25°C		138		132	ns		
		-40°C		132		123			
		85°C		154		146			
t _f	Fall time V _{I(PP)} = ±10 V, R _L = 10 kΩ, C _L = 100 pF, See Figures 1 and 2	25°C		138		132	ns		
		-40°C		132		123			
		85°C		154		146			
Overshoot factor		25°C		11%		5%			
		-40°C		12%		5%			
		85°C		13%		7%			
V _n	Equivalent input noise voltage R _S = 20 Ω, See Figure 3	25°C	TL034I	f = 10 Hz		83	83		
				f = 1 kHz		43		43	
		25°C	TL034AI	f = 10 Hz		83	83		
				f = 1 kHz		43	43	60	
I _n	Equivalent input noise current f = 1 kHz	25°C		0.003		0.003	pA/√Hz		
B ₁	Unity-gain bandwidth V _I = 10 mV, C _L = 25 pF, R _L = 10 kΩ, See Figure 4	25°C		1		1.1	MHz		
		-40°C		1		1.1			
		85°C		0.9		1			
φ _m	Phase margin at unity gain V _I = 10 mV, C _L = 25 pF, R _L = 10 kΩ, See Figure 4	25°C		61°		65°			
		-40°C		61°		65°			
		85°C		60°		64°			

† For V_{CC±} = ±5 V, V_{I(PP)} = ±1 V; for V_{CC±} = ±15 V, V_{I(PP)} = ±5 V.



TL03x, TL03xA, TL03xY
ENHANCED-JFET LOW-POWER LOW-OFFSET
OPERATIONAL AMPLIFIERS

SLOS180B – FEBRUARY 1997 – REVISED FEBRUARY 1999

TL034M and TL034AM electrical characteristics at specified free-air temperature

PARAMETER	TEST CONDITIONS		T _A	TL034M, TL034AM						UNIT
				V _{CC±} = ±5 V			V _{CC±} = ±15 V			
				MIN	TYP	MAX	MIN	TYP	MAX	
V _{IO} Input offset voltage	V _O = 0, V _{IC} = 0, R _S = 50 Ω	TL034M	25°C	0.91	3.6	0.78	4	mV		
			Full range†	11		9				
		TL034AM	25°C	0.7	3.5	0.58	1.5			
			Full range†	8.5		6.5				
α _{VIO} Temperature coefficient of input offset voltage	V _O = 0, V _{IC} = 0, R _S = 50 Ω	TL034M	25°C to 125°C	10.6		10.9		μV/°C		
		TL034AM	25°C to 125°C	10.6		10.9				
Input offset voltage long-term drift‡			25°C	0.04		0.04		μV/mo		
I _{IO} Input offset current	V _O = 0, V _{IC} = 0, See Figure 5		25°C	1	100	1	100	pA		
			125°C	0.2	10	0.2	10	nA		
I _{IB} Input bias current	V _O = 0, V _{IC} = 0, See Figure 5		25°C	2	200	2	200	pA		
			125°C	7	20	8	20	nA		
V _{ICR} Common-mode input voltage range			25°C	-1.5 to 4	-3.4 to 5.4	-11.5 to 14	-13.4 to 15.4	V		
			Full range†	-1.5 to 4		-11.5 to 14				
V _{OM+} Maximum positive peak output voltage swing	R _L = 10 kΩ		25°C	3	4.3	13	14	V		
			-55°C	3	4.1	13	14			
			125°C	3	4.4	13	14			
V _{OM-} Maximum negative peak output voltage swing	R _L = 10 kΩ		25°C	-3	-4.2	-12.5	-13.9	V		
			-55°C	-3	-4	-12.5	-13.8			
			125°C	-3	-4.3	-12.5	-14			
A _{VD} Large-signal differential voltage amplification§	R _L = 10 kΩ		25°C	4	12	5	14.3	V/mV		
			-55°C	3	7.1	4	10.4			
			125°C	3	12.9	4	15			
r _i Input resistance			25°C	10 ¹²		10 ¹²		Ω		
c _i Input capacitance			25°C	5		4		pF		
CMRR Common-mode rejection ratio	V _{IC} = V _{ICR} min, V _O = 0, R _S = 50 Ω		25°C	70	87	75	94	dB		
			-55°C	70	87	70	94			
			125°C	70	87	70	94			
k _{SVR} Supply-voltage rejection ratio (ΔV _{CC±} /ΔV _{IO})	V _O = 0, R _S = 50 Ω		25°C	75	96	75	96	dB		
			-55°C	75	95	75	95			
			125°C	75	96	75	96			

† Full range is -55°C to 125°C.

‡ Typical values are based on the input offset voltage shift observed through 168 hours of operating life test at T_A = 150°C extrapolated to T_A = 25°C using the Arrhenius equation and assuming an activation energy of 0.96 eV.

§ At V_{CC±} = ±5 V, V_O = ±2.3 V; at V_{CC±} = ±15 V, V_O = ±10 V.



TL03x, TL03xA, TL03xY ENHANCED-JFET LOW-POWER LOW-OFFSET OPERATIONAL AMPLIFIERS

SLOS180B – FEBRUARY 1997 – REVISED FEBRUARY 1999

TL034M and TL034AM electrical characteristics at specified free-air temperature (continued)

PARAMETER	TEST CONDITIONS	T _A	TL034M, TL034AM						UNIT
			V _{CC±} = ±5 V			V _{CC±} = ±15 V			
			MIN	TYP	MAX	MIN	TYP	MAX	
P _D Total power dissipation (two amplifiers)	V _O = 0, No load	25°C	7.7	10		26	34	mW	
		-55°C	4.6	12		18.7	45		
		125°C	7.1	12		23.6	45		
I _{CC} Supply current (two amplifiers)	V _O = 0, No load	25°C	0.77	1		0.87	1.12	mA	
		-55°C	0.46	1.2		0.62	1.5		
		125°C	0.71	1.2		0.79	1.5		
V _{O1} /V _{O2} Crosstalk attenuation	A _{VD} = 100	25°C	120		120		dB		

TL034M and TL034AM operating characteristics at specified free-air temperature

PARAMETER	TEST CONDITIONS	T _A	TL034M, TL034AM						UNIT
			V _{CC±} = ±5 V			V _{CC±} = ±15 V			
			MIN	TYP	MAX	MIN	TYP	MAX	
SR ⁺ Positive slew rate at unity gain†	R _L = 10 kΩ, C _L = 100 pF, See Figure 1	25°C		2		1.5	2.9	V/μs	
		-55°C		1.4		1	1.9		
		125°C		2.4		1	3.5		
SR ⁻ Negative slew rate at unity gain†		25°C		3.9		1.5	5.1	V/μs	
		-55°C		3.2		1	4.6		
		125°C		4.1		1	4.7		
t _r Rise time	V _I (PP) = ±10 V, R _L = 10 kΩ, C _L = 100 pF, See Figures 1 and 2	25°C		138		132	ns		
		-55°C		142		123			
		125°C		166		58			
t _f Fall time	V _I (PP) = ±10 V, R _L = 10 kΩ, C _L = 100 pF, See Figure 1	25°C		138		132	ns		
		-55°C		142		123			
		125°C		166		158			
Overshoot factor	V _I (PP) = ±10 V, R _L = 10 kΩ, C _L = 100 pF, See Figures 1 and 2	25°C		11%		5%			
		-55°C		16%		6%			
		125°C		14%		8%			
V _n Equivalent input noise voltage	TL034M	R _S = 20 Ω, See Figure 3	f = 10 Hz	25°C		83	nV/√Hz		
			f = 1 kHz		43				
	TL034AM	f = 10 Hz	25°C		83				
		f = 1 kHz		43					
I _n Equivalent input noise current	f = 1 kHz	25°C		0.003		0.003	pA/√Hz		
B1 Unity-gain bandwidth	V _I = 10 mV, C _L = 25 pF, R _L = 10 kΩ, See Figure 4	25°C		1		1.1	MHz		
		-55°C		1		1.1			
		125°C		0.9		0.9			
φ _m Phase margin at unity gain	V _I = 10 mV, C _L = 25 pF, R _L = 10 kΩ, See Figure 4	25°C		61°		65°			
		-55°C		57°		64°			
		125°C		59°		62°			

† For V_{CC±} = ±5 V, V_I(PP) = ±1 V; for V_{CC±} = ±15 V, V_I(PP) = ±5 V.



TL03x, TL03xA, TL03xY
ENHANCED-JFET LOW-POWER LOW-OFFSET
OPERATIONAL AMPLIFIERS

SLOS180B – FEBRUARY 1997 – REVISED FEBRUARY 1999

TL034Y electrical characteristics, $T_A = 25^\circ\text{C}$

PARAMETER	TEST CONDITIONS	TL034Y						UNIT
		$V_{CC\pm} = \pm 5\text{ V}$			$V_{CC\pm} = \pm 15\text{ V}$			
		MIN	TYP	MAX	MIN	TYP	MAX	
V_{IO}	Input offset voltage	$V_O = 0, V_{IC} = 0,$		0.91		0.79		mV
α_{VIO}	Temperature coefficient of input offset voltage	$R_S = 50\ \Omega$		11.6		12		$\mu\text{V}/^\circ\text{C}$
I_{IO}	Input offset current	$V_O = 0, V_{IC} = 0,$		1		1		pA
		See Figure 5		2		2		
I_{IB}	Input bias current	$V_O = 0, V_{IC} = 0,$		2		2		pA
		See Figure 5		7		8		nA
V_{ICR}	Common-mode input voltage range			-3.4 to 5.4		-13.4 to 15.4		V
V_{OM+}	Maximum positive peak output voltage swing	$R_L = 10\ \text{k}\Omega$		4.3		14		V
V_{OM-}	Maximum negative peak output voltage swing	$R_L = 10\ \text{k}\Omega$		-4.2		-13.9		V
A_{VD}	Large-signal differential voltage amplification†	$R_L = 10\ \text{k}\Omega$		12		14.3		V/mV
r_i	Input resistance			10^{12}		10^{12}		Ω
c_i	Input capacitance			5		4		pF
CMRR	Common-mode rejection ratio	$V_{IC} = V_{ICRmin},$ $V_O = 0, R_S = 50\ \Omega$		87		94		dB
k_{SVR}	Supply-voltage rejection ratio ($\Delta V_{CC\pm}/\Delta V_{IO}$)	$V_O = 0, R_S = 50\ \Omega$		96		96		dB
P_D	Total power dissipation (four amplifiers)	$V_O = 0,$ No load		7.7		26		mW
I_{CC}	Supply current (four amplifiers)	$V_O = 0,$ No load		0.77		0.87		mA
V_{O1}/V_{O2}	Crosstalk attenuation	$A_{VD} = 100$		120		120		dB

† At $V_{CC\pm} = \pm 5\text{ V}, V_O = \pm 2.3\text{ V}$; at $V_{CC\pm} = \pm 15\text{ V}, V_O = \pm 10\text{ V}$.

TL034Y operating characteristics, $T_A = 25^\circ\text{C}$

PARAMETER	TEST CONDITIONS	TL034Y						UNIT
		$V_{CC\pm} = \pm 5\text{ V}$			$V_{CC\pm} = \pm 15\text{ V}$			
		MIN	TYP	MAX	MIN	TYP	MAX	
SR+	Positive slew rate at unity gain	$R_L = 10\ \text{k}\Omega, C_L = 100\ \text{pF},$		2		1.5 2.9		V/ μs
SR-	Negative slew rate at unity gain	See Figure 1		3.9		1.5 5.1		V/ μs
t_r	Rise time	$V_{I(PP)} = \pm 10\text{ V},$		138		132		ns
t_f	Fall time	$R_L = 10\ \text{k}\Omega, C_L = 100\ \text{pF},$		138		132		ns
	Overshoot factor	See Figures 1 and 2		11%		5%		
V_n	Equivalent input noise voltage	$R_S = 20\ \Omega,$ See Figure 3		f = 10 kHz		83		nV/ $\sqrt{\text{Hz}}$
				f = 1 kHz		43		
I_n	Equivalent input noise current	f = 1 kHz		0.003		0.003		pA/ $\sqrt{\text{Hz}}$
B1	Unity-gain bandwidth	$V_I = 10\ \text{mV}, C_L = 25\ \text{pF},$		1		1.1		MHz
ϕ_m	Phase margin at unity gain	$V_I = 10\ \text{mV}, C_L = 25\ \text{pF},$		61°		65°		
		See Figure 4						



PARAMETER MEASUREMENT INFORMATION

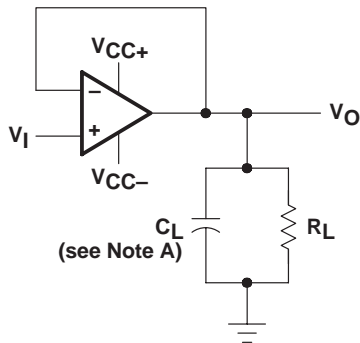

NOTE A: C_L includes fixture capacitance.

Figure 1. Slew-Rate and Overshoot Test Circuit

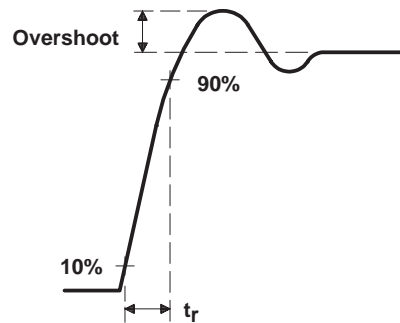

Figure 2. Rise Time and Overshoot Waveform

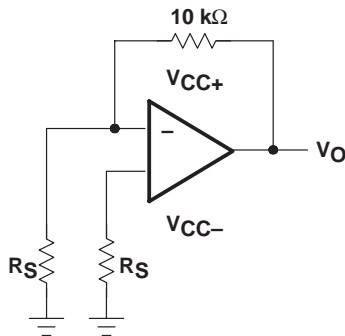
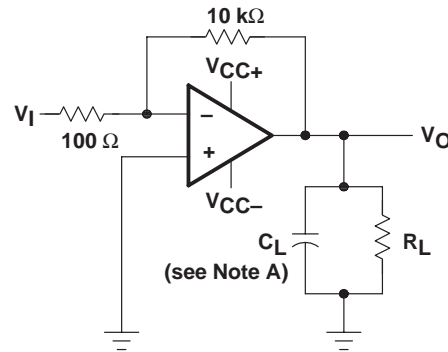

Figure 3. Noise-Voltage Test Circuit



NOTE A: C_L includes fixture capacitance.

Figure 4. Unity-Gain Bandwidth and Phase-Margin Test Circuit

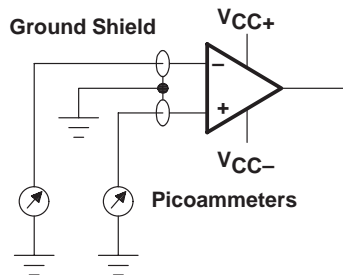

Figure 5. Input-Bias and Offset-Current Test Circuit

PARAMETER MEASUREMENT INFORMATION

typical values

Typical values presented in this data sheet represent the median (50% point) of device parametric performance.

input bias and offset current

At the picoampere bias current level typical of the TL03x and TL03xA, accurate measurement of the bias current becomes difficult. Not only does this measurement require a picoammeter, but test-socket leakages easily can exceed the actual device bias currents. To accurately measure these small currents, Texas Instruments uses a two-step process. The socket leakage is measured using picoammeters with bias voltages applied but with no device in the socket. The device is then inserted into the socket and a second test that measures both the socket leakage and the device input bias current is performed. The two measurements are then subtracted algebraically to determine the bias current of the device.

noise

With the increasing emphasis on low noise levels in many of today's applications, the input noise voltage density is performed at $f = 1$ kHz, unless otherwise noted.

TL03x, TL03xA, TL03xY
ENHANCED-JFET LOW-POWER LOW-OFFSET
OPERATIONAL AMPLIFIERS

SLOS180B – FEBRUARY 1997 – REVISED FEBRUARY 1999

TYPICAL CHARACTERISTICS

Table of Graphs

	FIGURE
Distribution of TL03x input offset voltages	6 – 11
Distribution of TL03x input offset-voltage temperature coefficients	12, 13, 14
Input bias current vs Common-mode input voltage	15
Input bias current and Input offset current vs Free-air temperature	16
Common-mode input voltage range vs Supply voltage	17
Common-mode input voltage range vs Free-air temperature	18
Output voltage vs Differential input voltage	19, 20
Maximum peak output voltage vs Supply voltage	21
Maximum peak-to-peak output voltage vs Frequency	22
Maximum peak output voltage vs Output current	23, 24
Maximum peak output voltage vs Free-air temperature	25, 26
Large-signal differential voltage amplification vs Load resistance	27
Large-signal differential voltage amplification and Phase shift vs Frequency	28
Large-signal differential voltage amplification and Phase shift vs Free-air temperature	29
Output impedance vs Frequency with $V_{CC\pm} = \pm 15\text{ V}$	30
Common-mode rejection ratio vs Frequency	31, 32
Common-mode rejection ratio vs Free-air temperature	33
Supply-voltage rejection ratio vs Free-air temperature	34
Short-circuit output current vs Supply voltage	35
Short-circuit output current vs Time	36
Short-circuit output current vs Free-air temperature	37
Equivalent input noise voltage vs Frequency (for TL031 and TL031A)	38
Equivalent input noise voltage vs Frequency (for TL032 and TL032A)	39
Equivalent input noise voltage vs Frequency (for TL034 and TL034A)	40
Supply current vs Supply voltage (for TL031 and TL031A)	41
Supply current vs Supply voltage (for TL032 and TL032A)	42
Supply current vs Supply voltage (for TL034 and TL034A)	43
Supply current vs Free-air temperature (for TL031 and TL031A)	44
Supply current vs Free-air temperature (for TL032 and TL032A)	45
Supply current vs Free-air temperature (for TL034 and TL034A)	46
Slew rate vs Load resistance	47, 48
Slew rate vs Free-air temperature	49, 50
Overshoot factor vs Load capacitance	51
Total harmonic distortion vs Frequency	52
Unity-gain bandwidth vs Supply voltage	53
Unity-gain bandwidth vs Free-air temperature	54
Phase margin vs Supply voltage	55
Phase margin vs Load capacitance	56
Phase margin vs Free-air temperature	57
Voltage-follower small-signal pulse response vs Time	58
Voltage-follower large-signal pulse response vs Time	59, 60



TYPICAL CHARACTERISTICS

DISTRIBUTION OF TL031
 INPUT OFFSET VOLTAGE

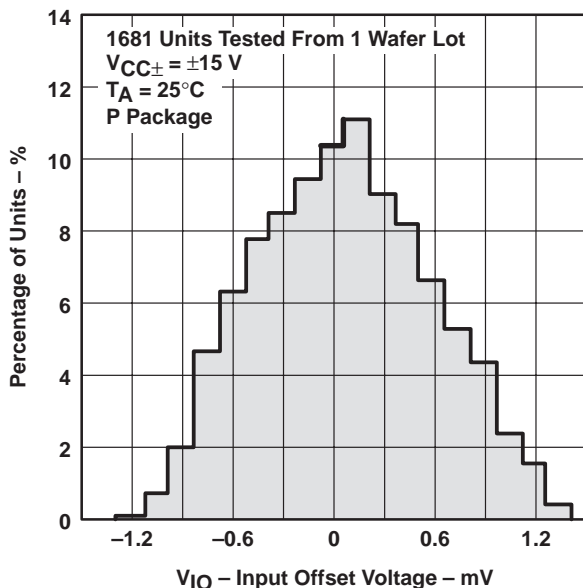

Figure 6

DISTRIBUTION OF TL031A
 INPUT OFFSET VOLTAGE

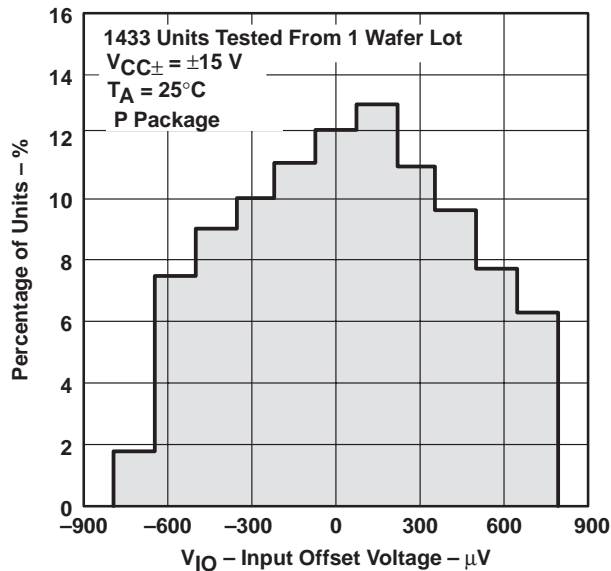

Figure 7

DISTRIBUTION OF TL032
 INPUT OFFSET VOLTAGE

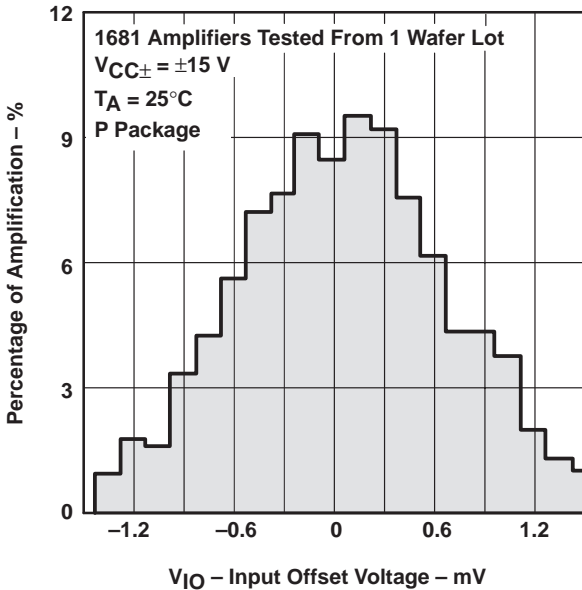

Figure 8

DISTRIBUTION OF TL032A
 INPUT OFFSET VOLTAGE

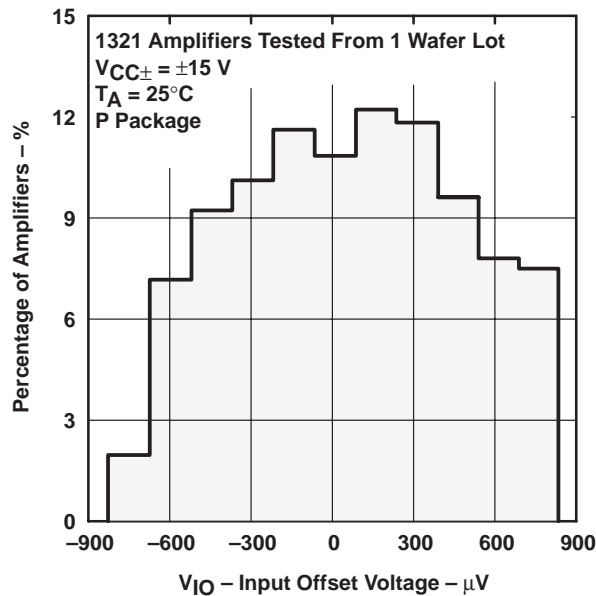

Figure 9

TL03x, TL03xA, TL03xY
ENHANCED-JFET LOW-POWER LOW-OFFSET
OPERATIONAL AMPLIFIERS

SLOS180B – FEBRUARY 1997 – REVISED FEBRUARY 1999

TYPICAL CHARACTERISTICS

**DISTRIBUTION OF TL034
 INPUT OFFSET VOLTAGE**

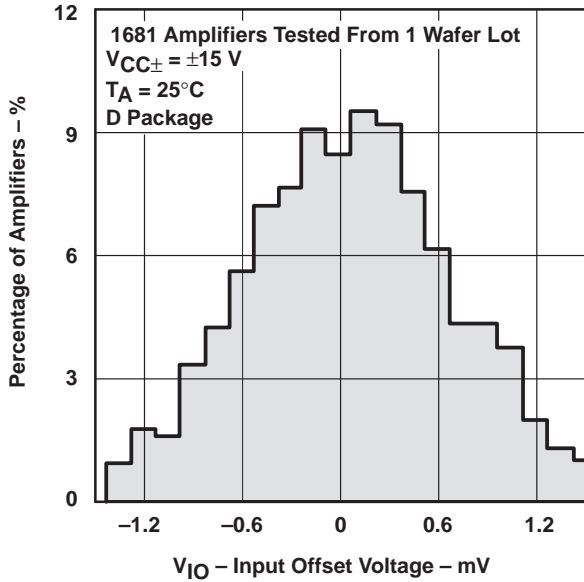

Figure 10

**DISTRIBUTION OF TL034A
 INPUT OFFSET VOLTAGE**

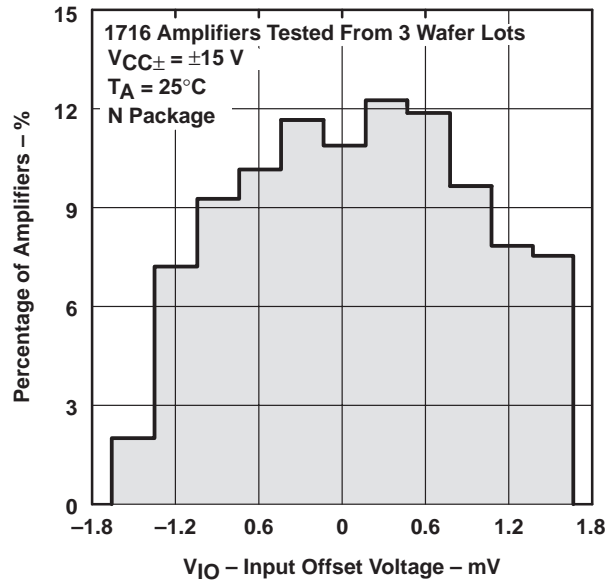

Figure 11

**DISTRIBUTION OF TL031
 INPUT OFFSET-VOLTAGE
 TEMPERATURE COEFFICIENT**

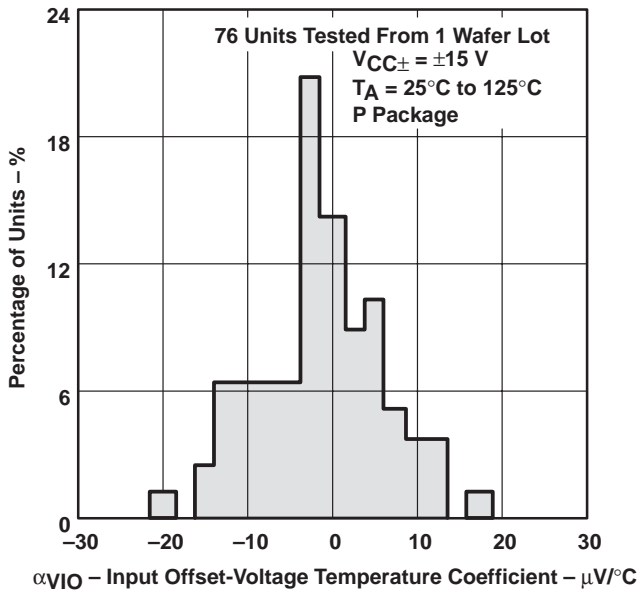

Figure 12

**DISTRIBUTION OF TL032
 INPUT OFFSET-VOLTAGE
 TEMPERATURE COEFFICIENT**

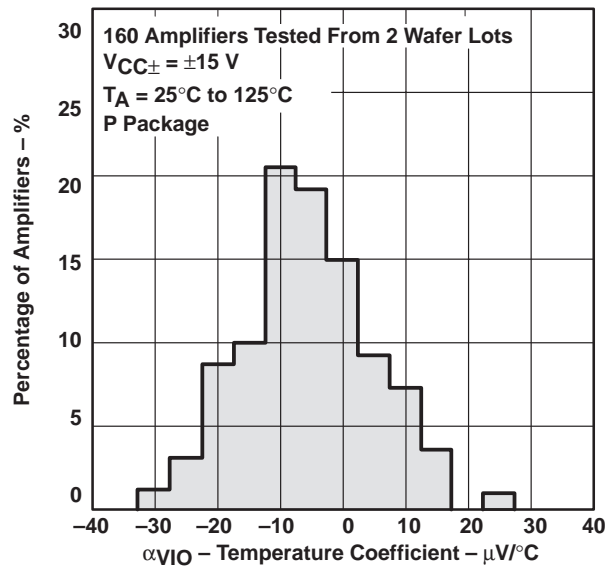

Figure 13

TYPICAL CHARACTERISTICS

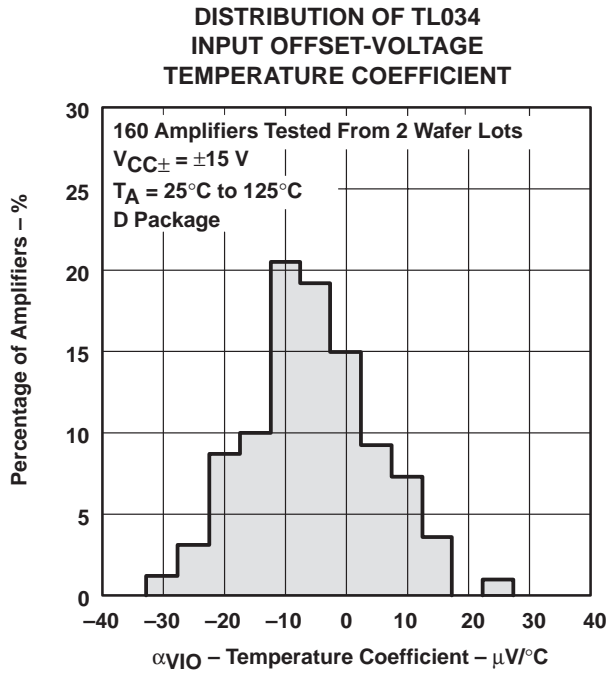

Figure 14

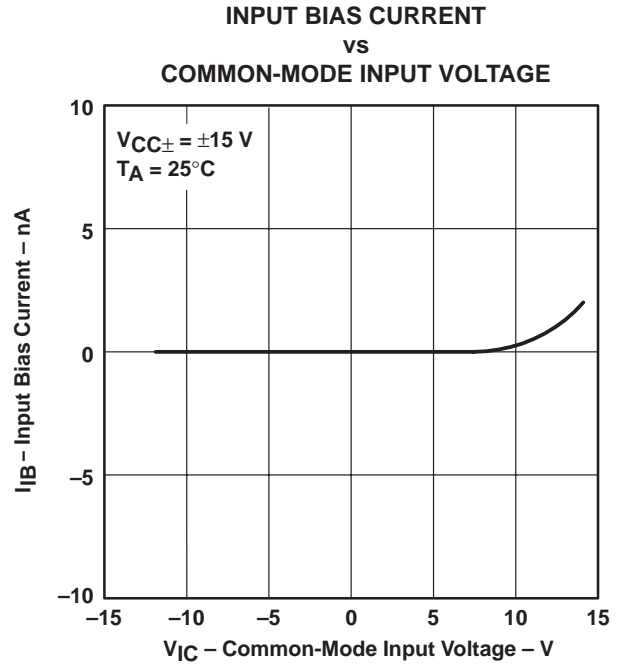

Figure 15

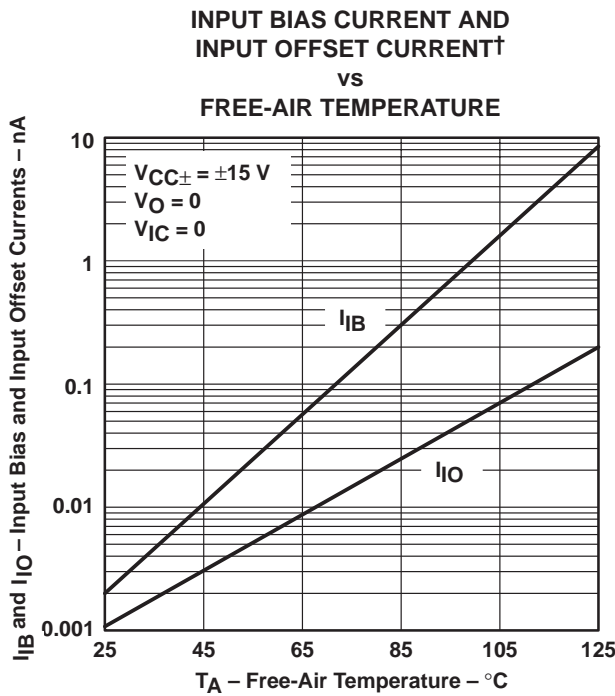

Figure 16

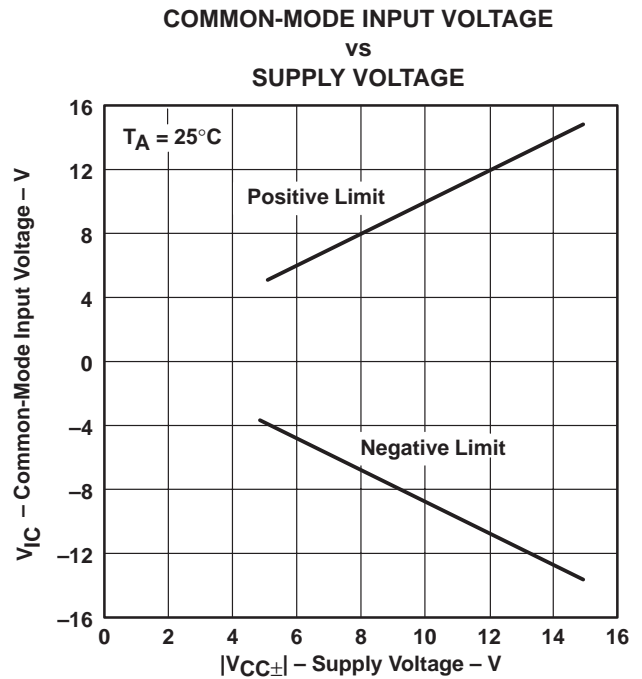

Figure 17

† Data at high and low temperatures are applicable only within the recommended operating free-air temperature ranges of the various devices.

TL03x, TL03xA, TL03xY
ENHANCED-JFET LOW-POWER LOW-OFFSET
OPERATIONAL AMPLIFIERS

SLOS180B – FEBRUARY 1997 – REVISED FEBRUARY 1999

TYPICAL CHARACTERISTICS

COMMON-MODE INPUT VOLTAGE RANGE†
vs
FREE-AIR TEMPERATURE

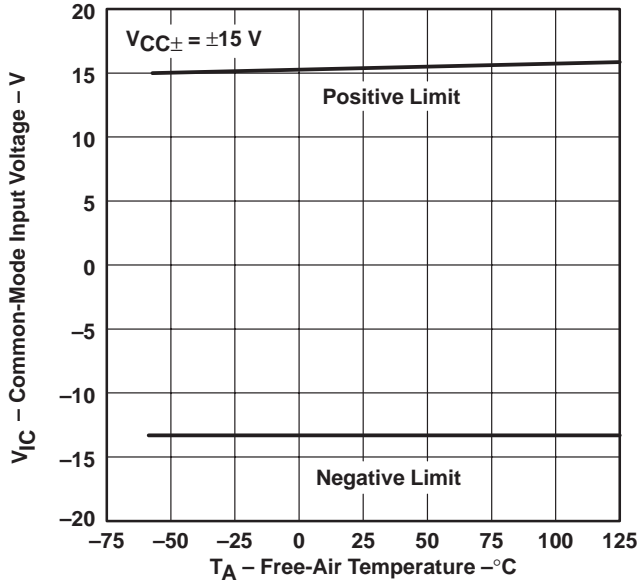

Figure 18

OUTPUT VOLTAGE
vs
DIFFERENTIAL INPUT VOLTAGE

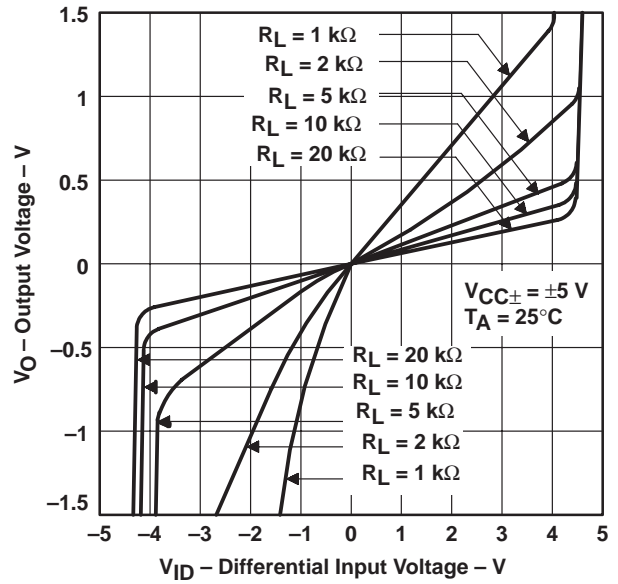

Figure 19

OUTPUT VOLTAGE
vs
DIFFERENTIAL INPUT VOLTAGE

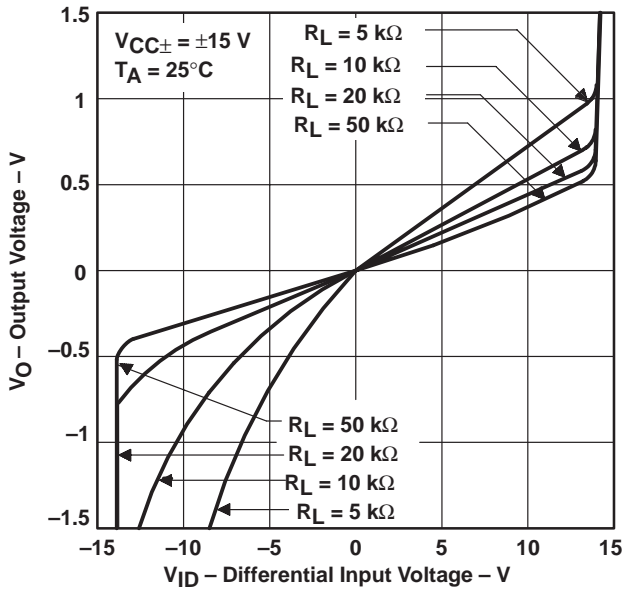

Figure 20

MAXIMUM PEAK OUTPUT VOLTAGE
vs
SUPPLY VOLTAGE

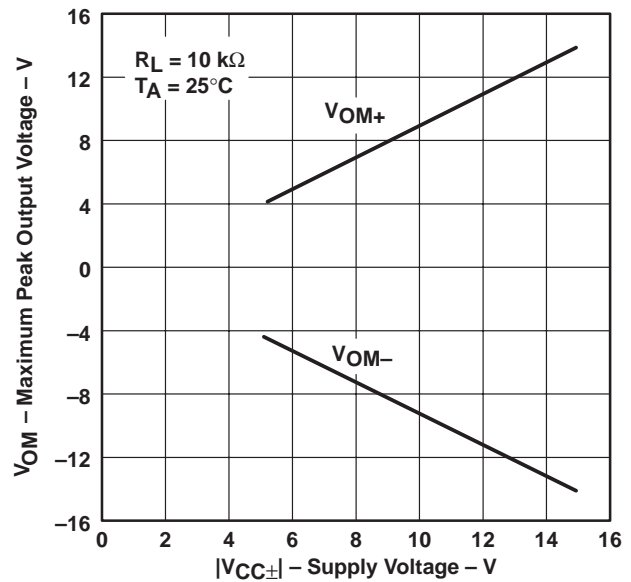

Figure 21

† Data at high and low temperatures are applicable only within the recommended operating free-air temperature ranges of the various devices.



TYPICAL CHARACTERISTICS

MAXIMUM PEAK-TO-PEAK OUTPUT VOLTAGE†
 vs
 FREQUENCY

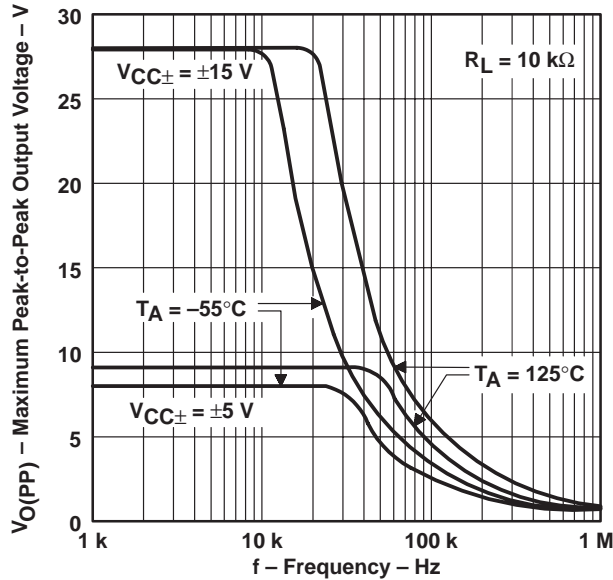

Figure 22

MAXIMUM PEAK OUTPUT VOLTAGE
 vs
 OUTPUT CURRENT

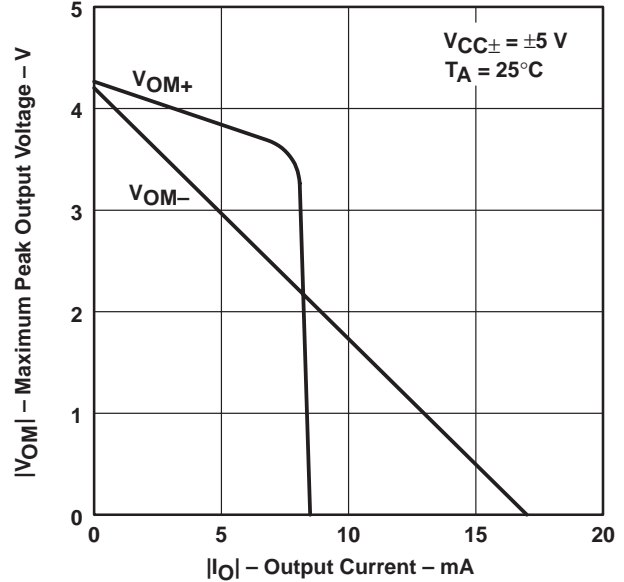

Figure 23

MAXIMUM PEAK OUTPUT VOLTAGE
 vs
 OUTPUT CURRENT

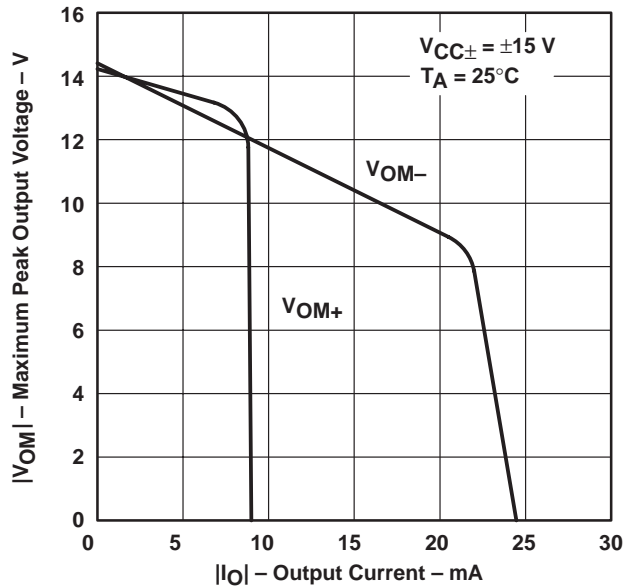

Figure 24

MAXIMUM PEAK OUTPUT VOLTAGE†
 vs
 FREE-AIR TEMPERATURE

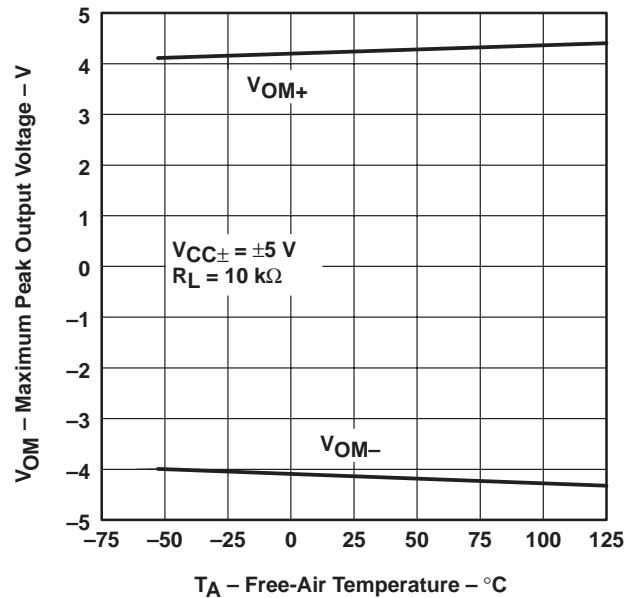

Figure 25

† Data at high and low temperatures are applicable only within the recommended operating free-air temperature ranges of the various devices.

TL03x, TL03xA, TL03xY
ENHANCED-JFET LOW-POWER LOW-OFFSET
OPERATIONAL AMPLIFIERS

SLOS180B – FEBRUARY 1997 – REVISED FEBRUARY 1999

TYPICAL CHARACTERISTICS

MAXIMUM PEAK OUTPUT VOLTAGE†
vs
FREE-AIR TEMPERATURE

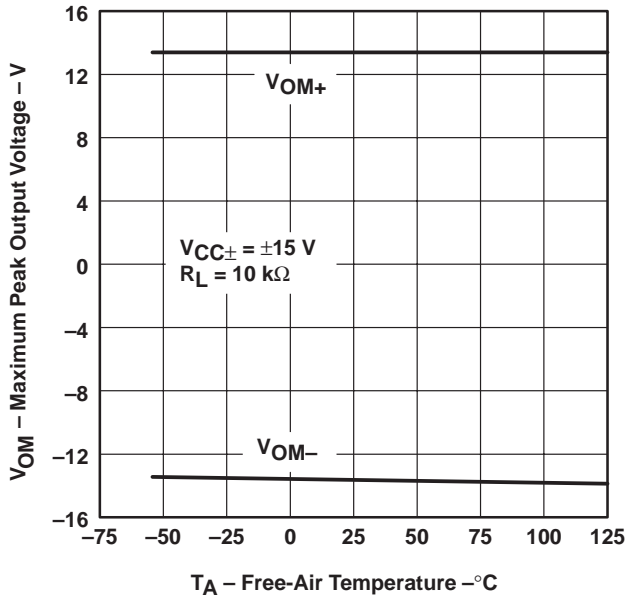

Figure 26

LARGE-SIGNAL DIFFERENTIAL
VOLTAGE AMPLIFICATION
vs
LOAD RESISTANCE

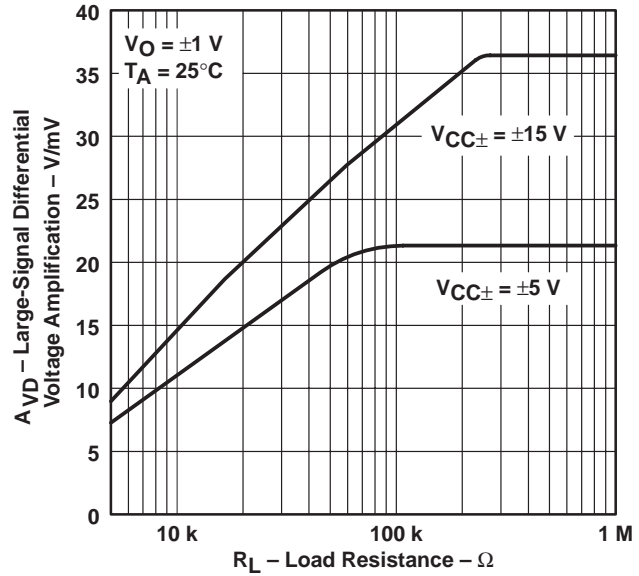

Figure 27

LARGE-SIGNAL DIFFERENTIAL VOLTAGE
AMPLIFICATION AND PHASE SHIFT
vs
FREQUENCY

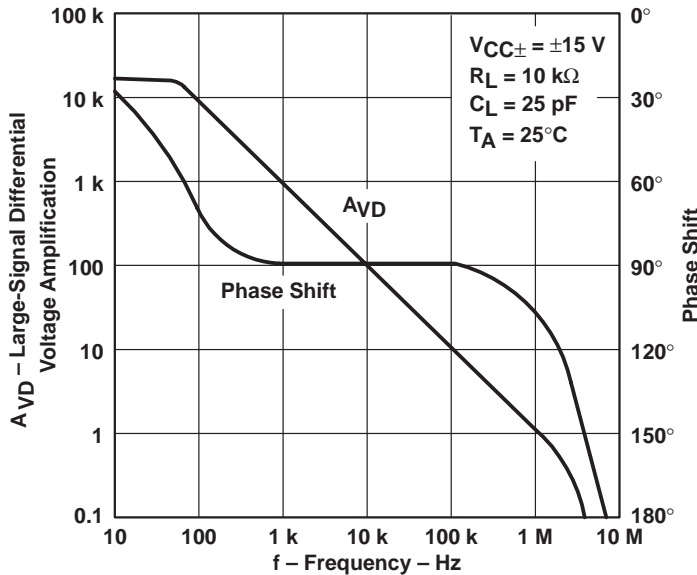

Figure 28

† Data at high and low temperatures are applicable only within the recommended operating free-air temperature ranges of the various devices.

TYPICAL CHARACTERISTICS

LARGE-SIGNAL DIFFERENTIAL
 VOLTAGE AMPLIFICATION†
 vs
 FREE-AIR TEMPERATURE

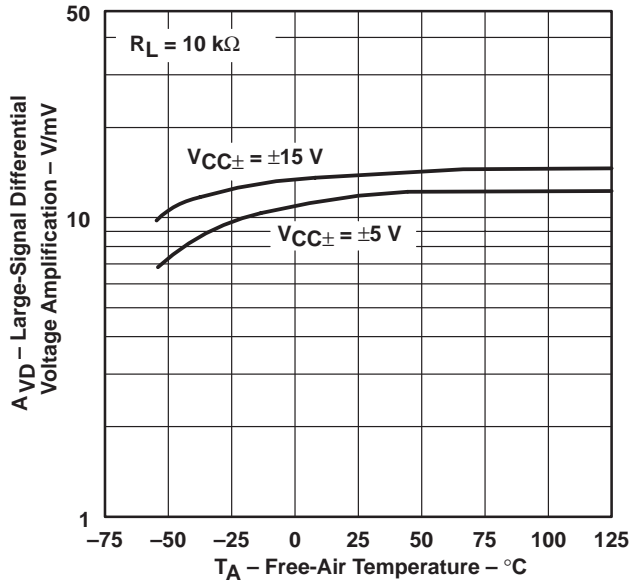

Figure 29

OUTPUT IMPEDANCE
 vs
 FREQUENCY

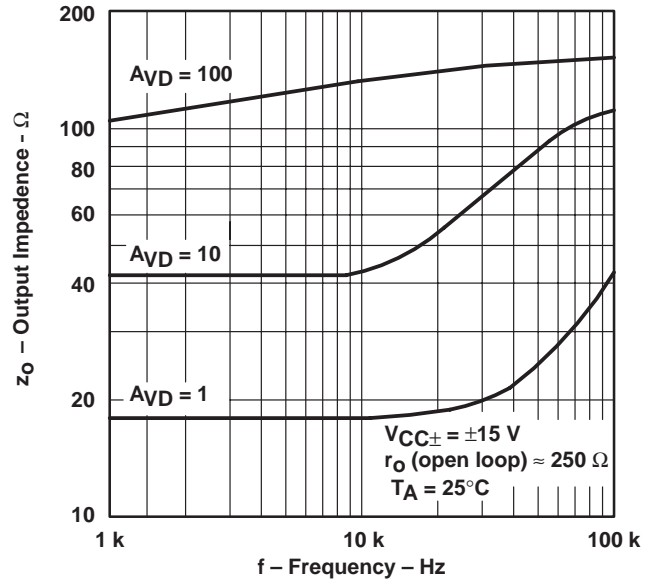

Figure 30

COMMON-MODE REJECTION RATIO
 vs
 FREQUENCY

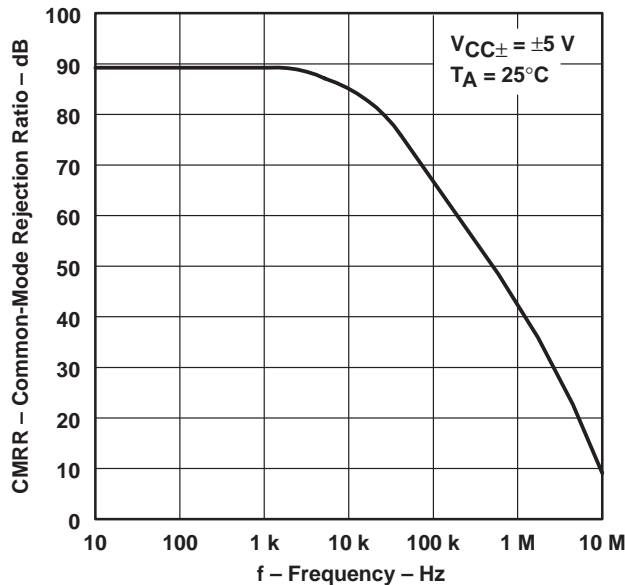

Figure 31

COMMON-MODE REJECTION RATIO
 vs
 FREQUENCY

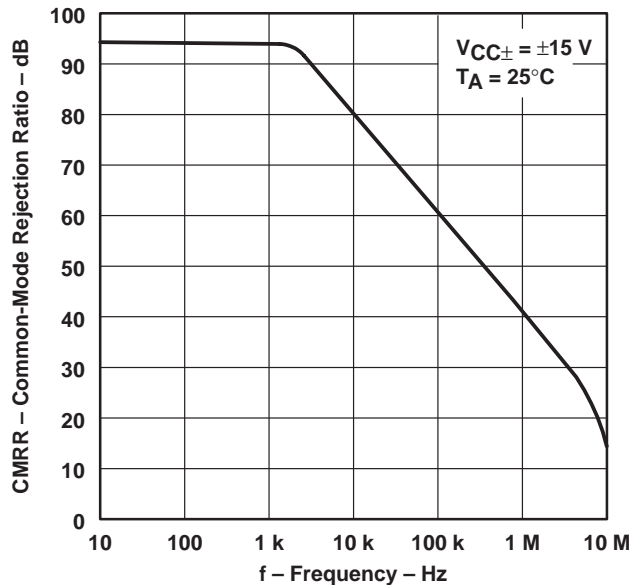

Figure 32

† Data at high and low temperatures are applicable only within the recommended operating free-air temperature ranges of the various devices.

TL03x, TL03xA, TL03xY ENHANCED-JFET LOW-POWER LOW-OFFSET OPERATIONAL AMPLIFIERS

SLOS180B – FEBRUARY 1997 – REVISED FEBRUARY 1999

TYPICAL CHARACTERISTICS

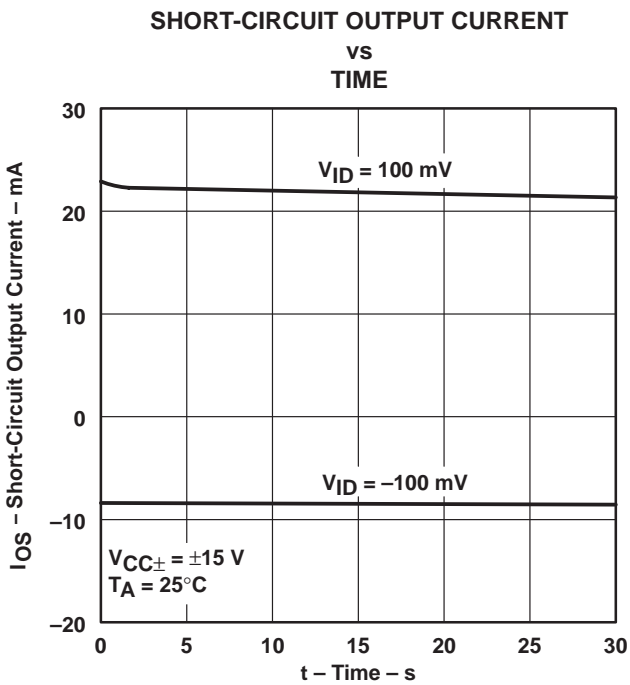
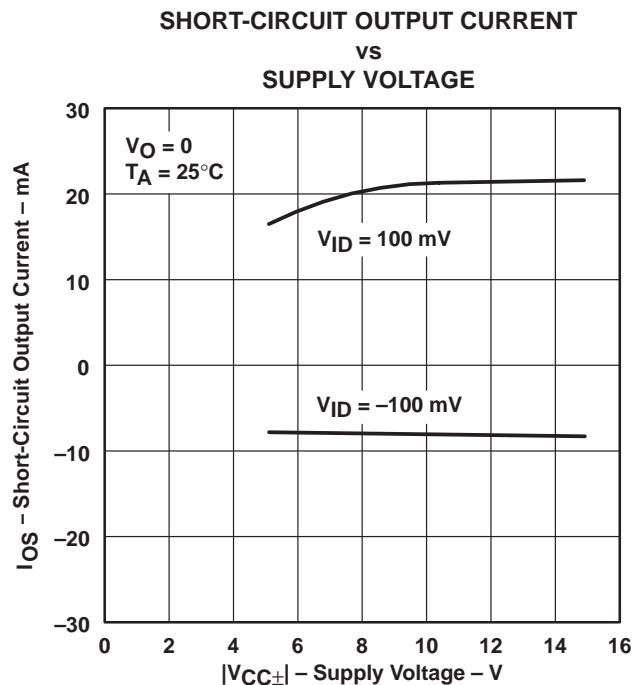
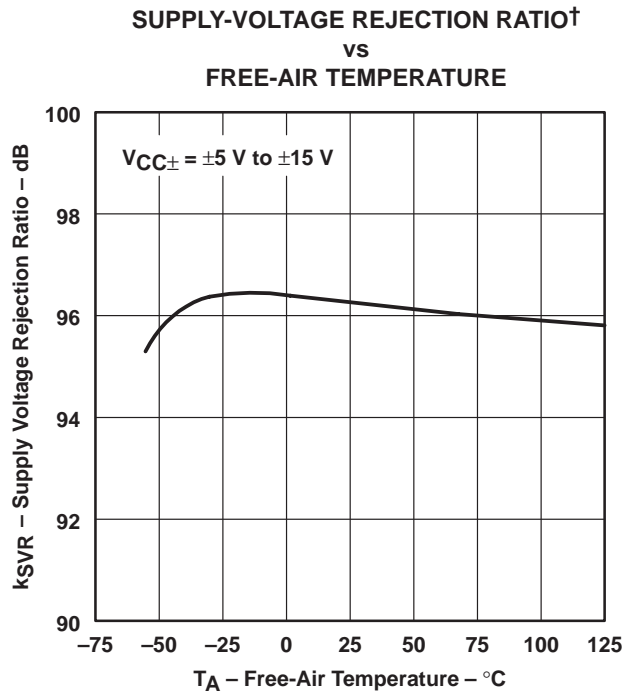
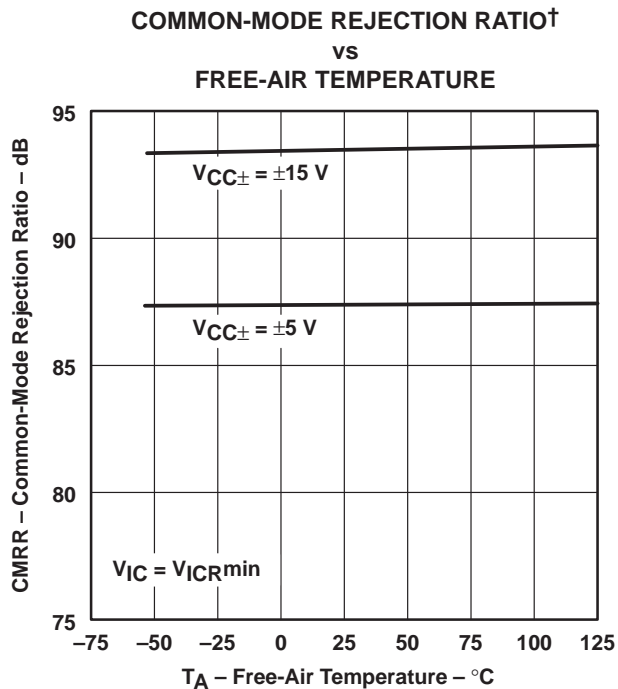

† Data at high and low temperatures are applicable only within the recommended operating free-air temperature ranges of the various devices.

TYPICAL CHARACTERISTICS

SHORT-CIRCUIT OUTPUT CURRENT†
 VS
 FREE-AIR TEMPERATURE

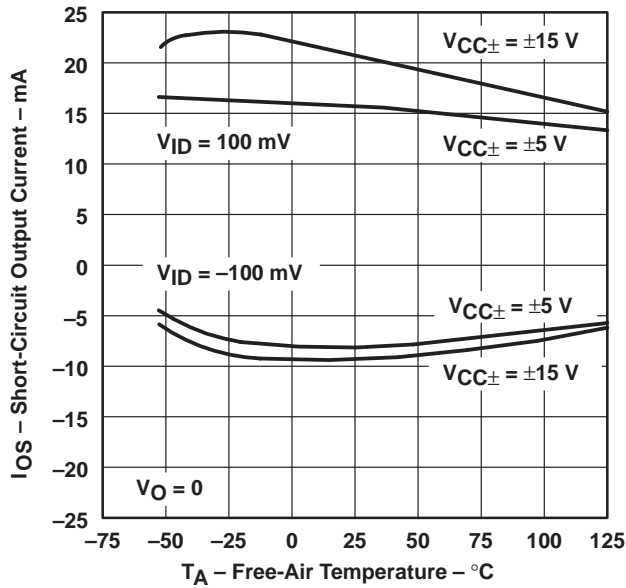

Figure 37

TL031 and TL031A
 EQUIVALENT INPUT NOISE VOLTAGE
 VS
 FREQUENCY

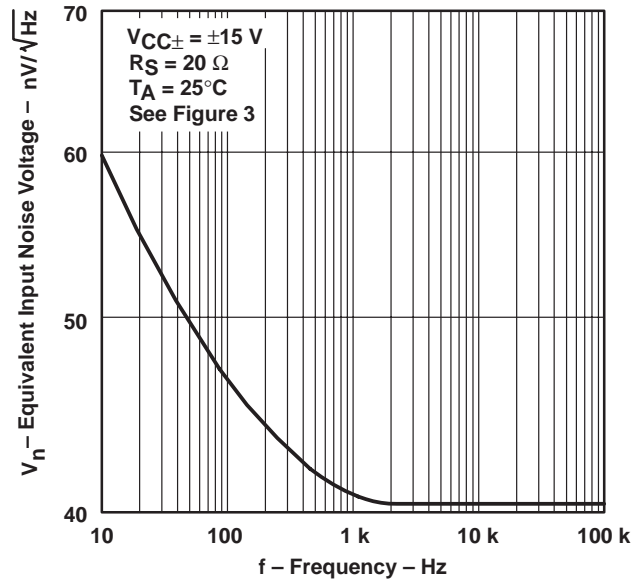

Figure 38

TL032 and TL032A
 EQUIVALENT INPUT NOISE VOLTAGE
 VS
 FREQUENCY

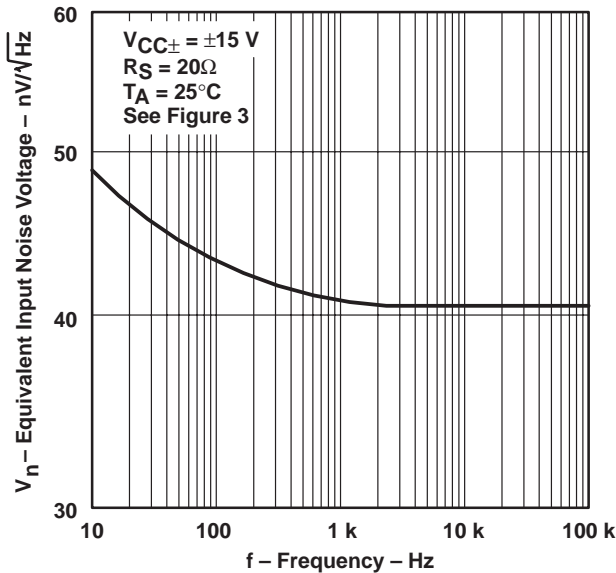

Figure 39

TL034 and TL034A
 EQUIVALENT INPUT NOISE VOLTAGE
 VS
 FREQUENCY

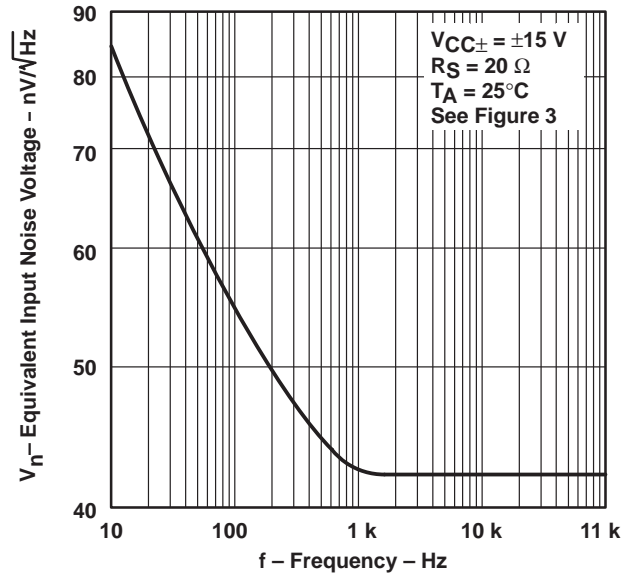

Figure 40

† Data at high and low temperatures are applicable only within the recommended operating free-air temperature ranges of the various devices.

TL03x, TL03xA, TL03xY
ENHANCED-JFET LOW-POWER LOW-OFFSET
OPERATIONAL AMPLIFIERS

SLOS180B – FEBRUARY 1997 – REVISED FEBRUARY 1999

TYPICAL CHARACTERISTICS

TL031 and TL031A
SUPPLY CURRENT†
vs
SUPPLY VOLTAGE

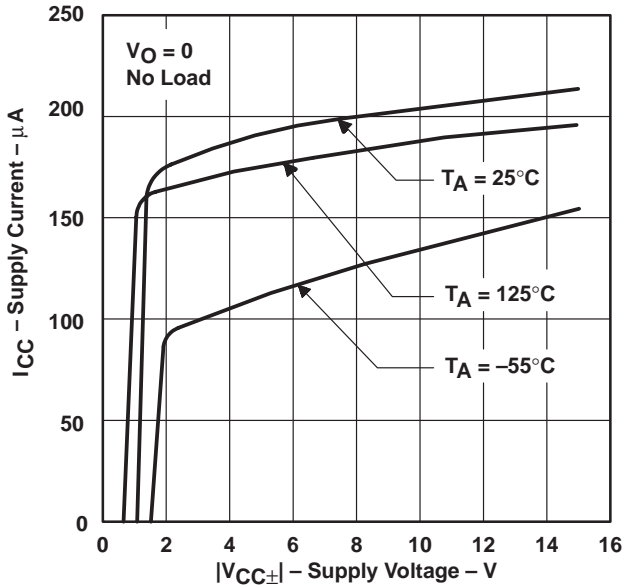

Figure 41

TL032 and TL032A
SUPPLY CURRENT†
vs
SUPPLY VOLTAGE

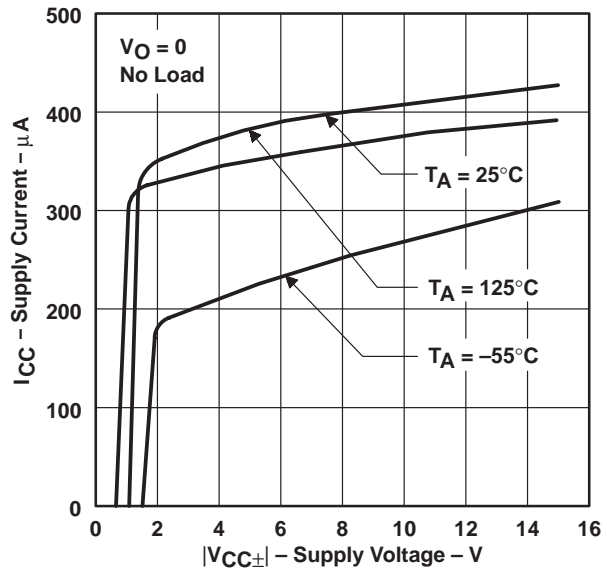

Figure 42

TL034 and TL034A
SUPPLY CURRENT†
vs
SUPPLY VOLTAGE

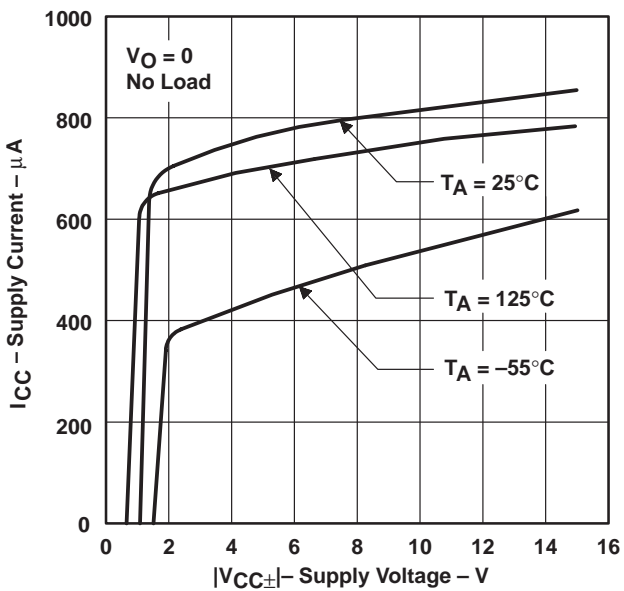

Figure 43

TL031 and TL031A
SUPPLY CURRENT†
vs
FREE-AIR TEMPERATURE

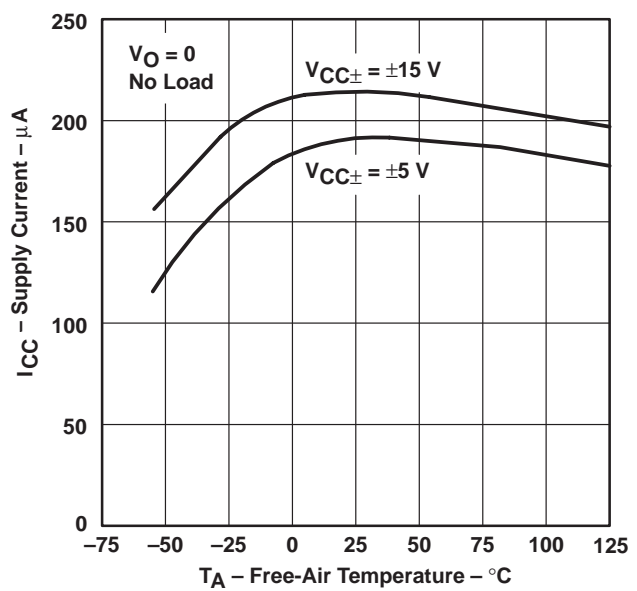
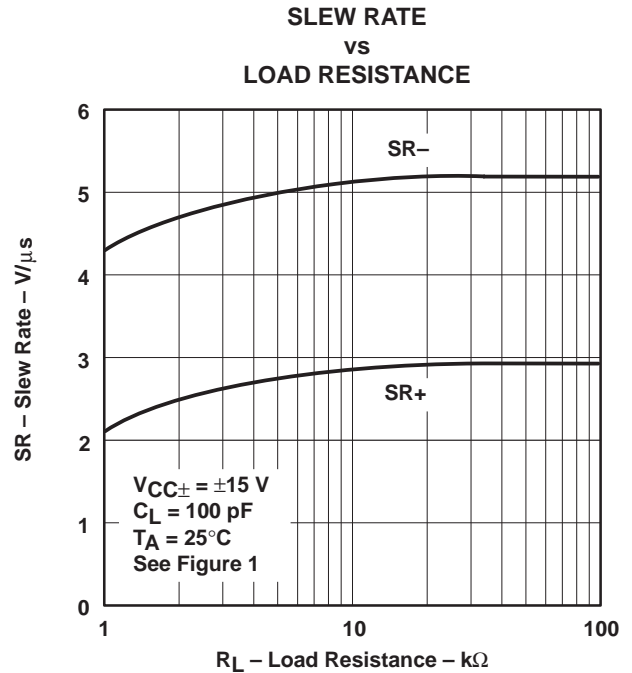
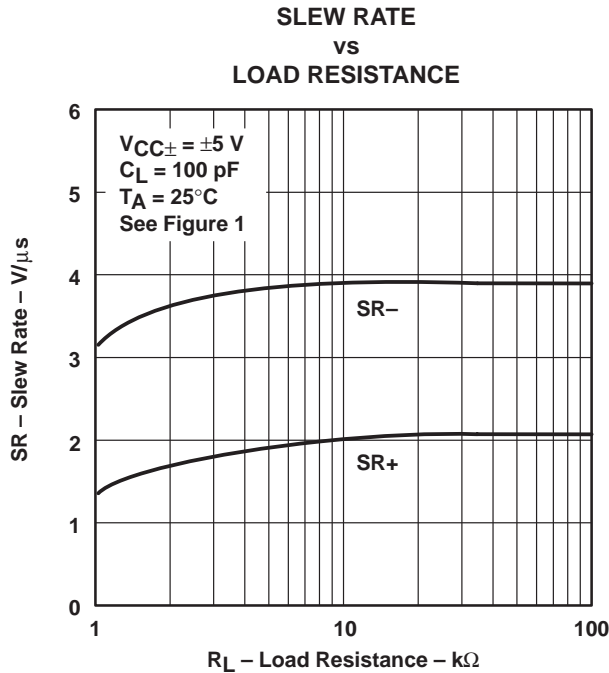
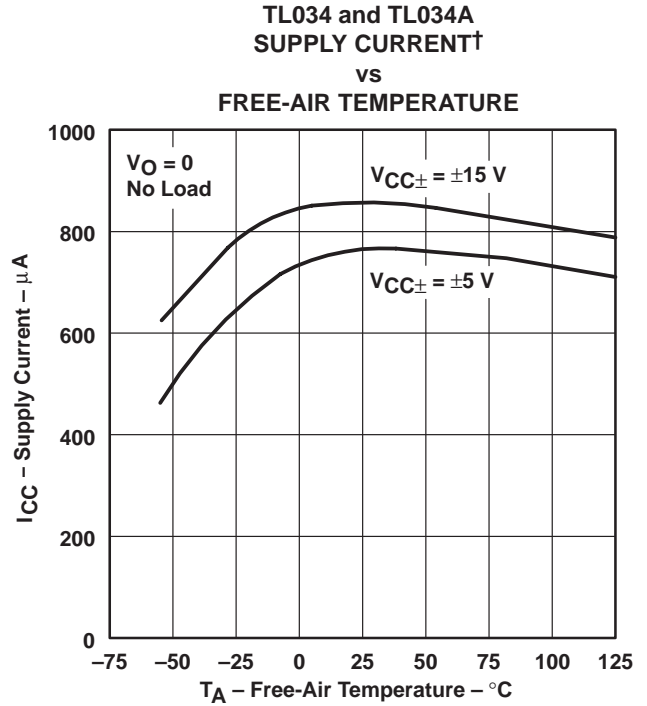
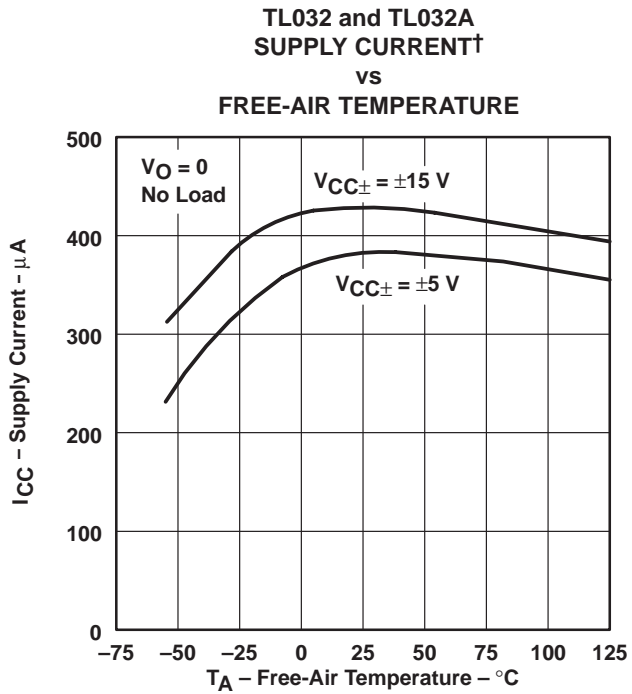

Figure 44

† Data at high and low temperatures are applicable only within the recommended operating free-air temperature ranges of the various devices.

TYPICAL CHARACTERISTICS



† Data at high and low temperatures are applicable only within the recommended operating free-air temperature ranges of the various devices.

TL03x, TL03xA, TL03xY
ENHANCED-JFET LOW-POWER LOW-OFFSET
OPERATIONAL AMPLIFIERS

SLOS180B – FEBRUARY 1997 – REVISED FEBRUARY 1999

TYPICAL CHARACTERISTICS

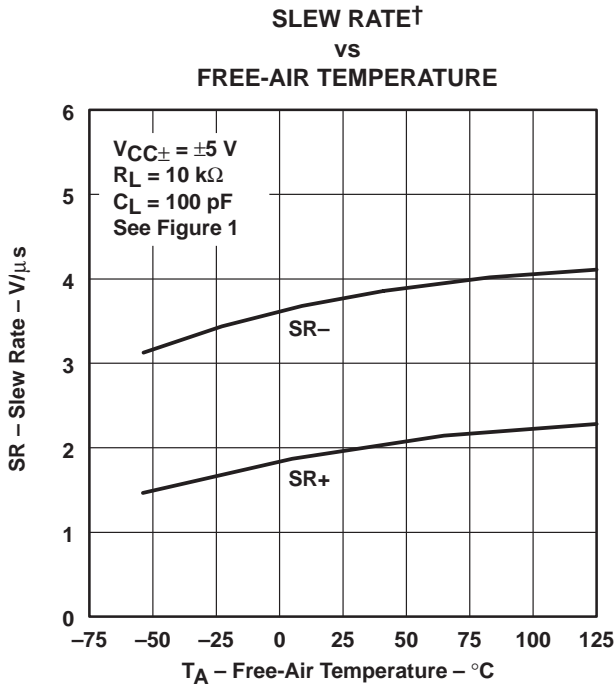

Figure 49

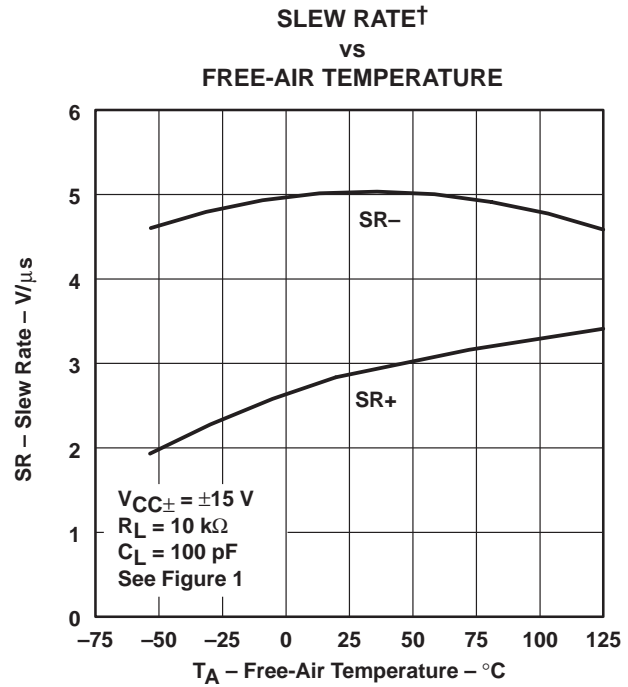

Figure 50

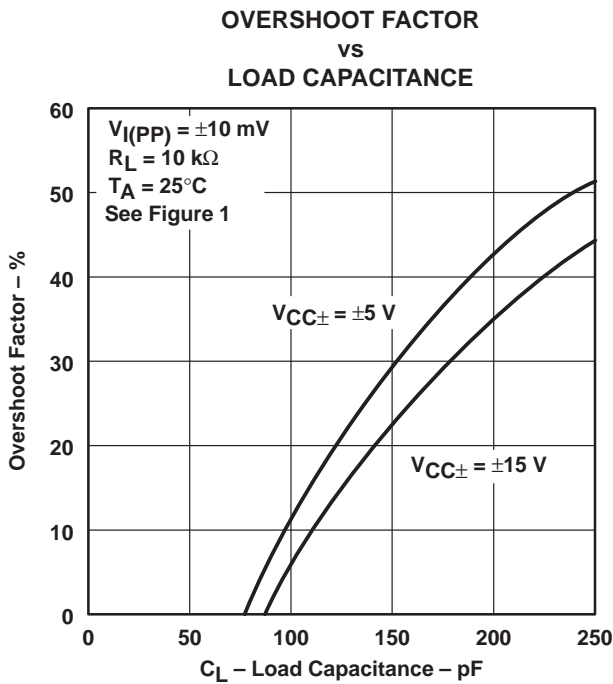

Figure 51

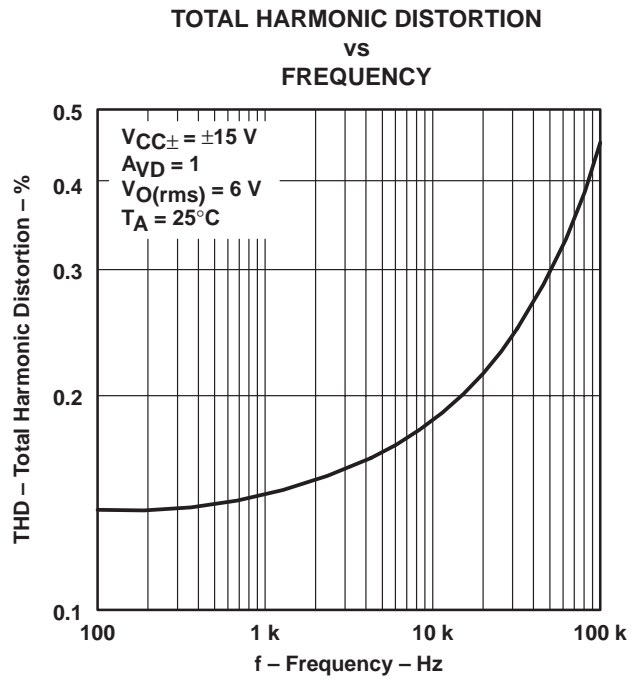
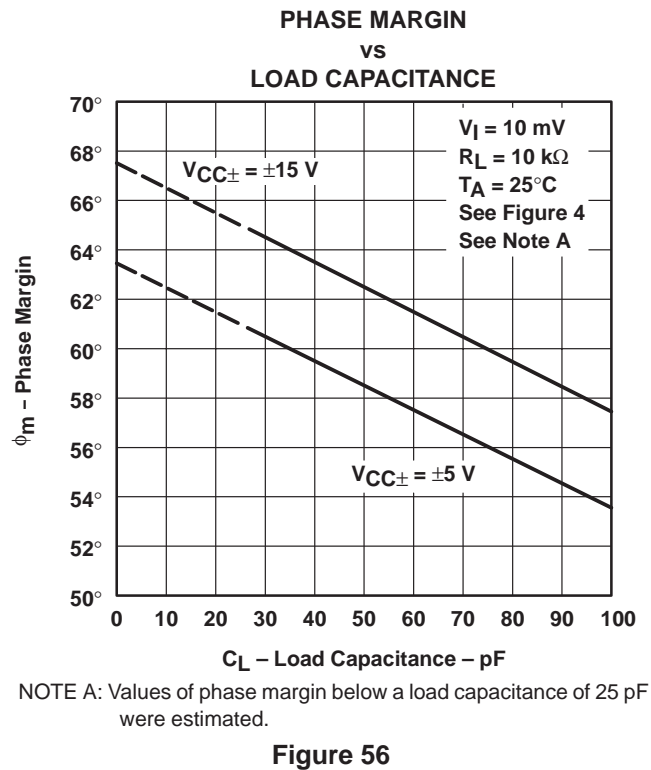
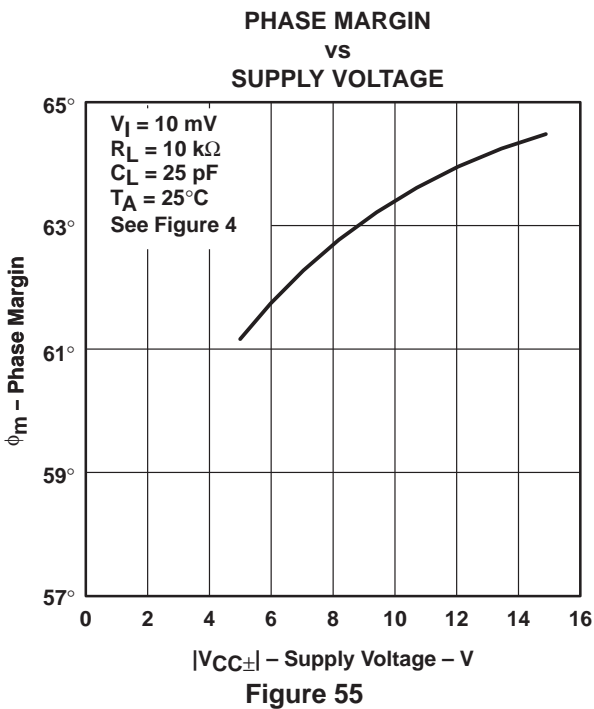
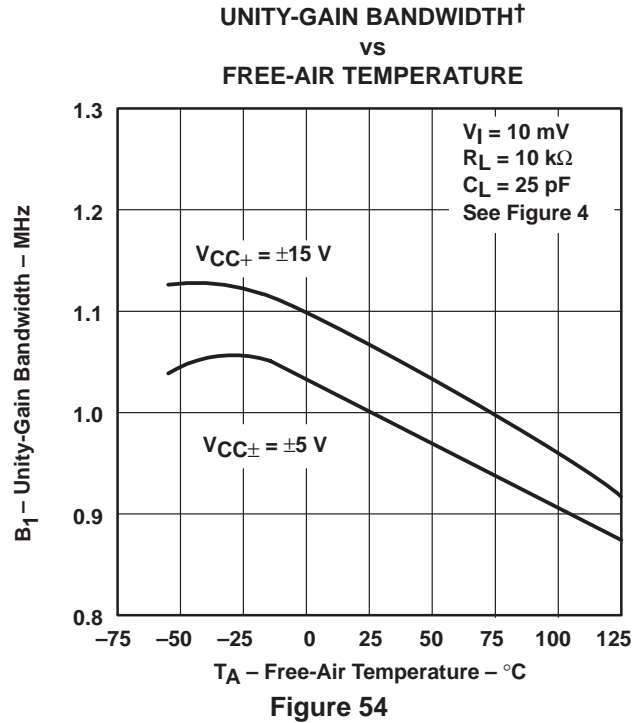
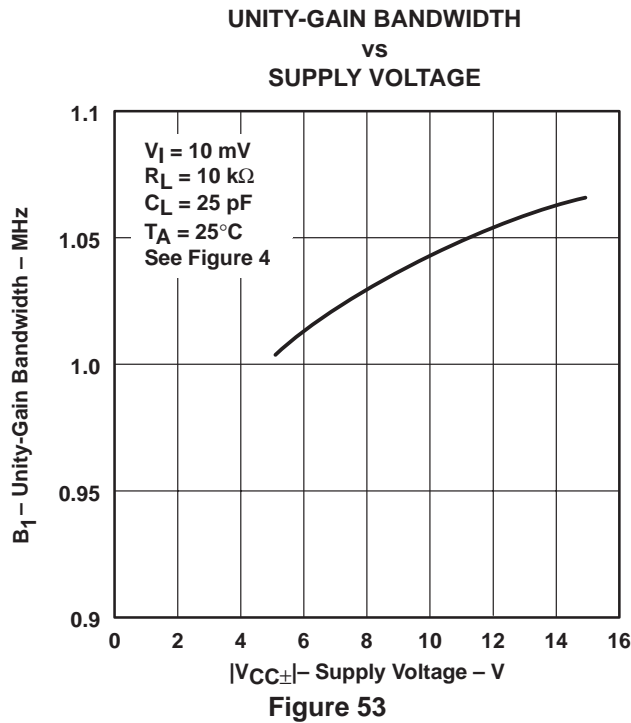

Figure 52

† Data at high and low temperatures are applicable only within the recommended operating free-air temperature ranges of the various devices.



TYPICAL CHARACTERISTICS



† Data at high and low temperatures are applicable only within the recommended operating free-air temperature ranges of the various devices.

TL03x, TL03xA, TL03xY
ENHANCED-JFET LOW-POWER LOW-OFFSET
OPERATIONAL AMPLIFIERS

SLOS180B – FEBRUARY 1997 – REVISED FEBRUARY 1999

TYPICAL CHARACTERISTICS

**PHASE MARGIN†
 vs
 FREE-AIR TEMPERATURE**

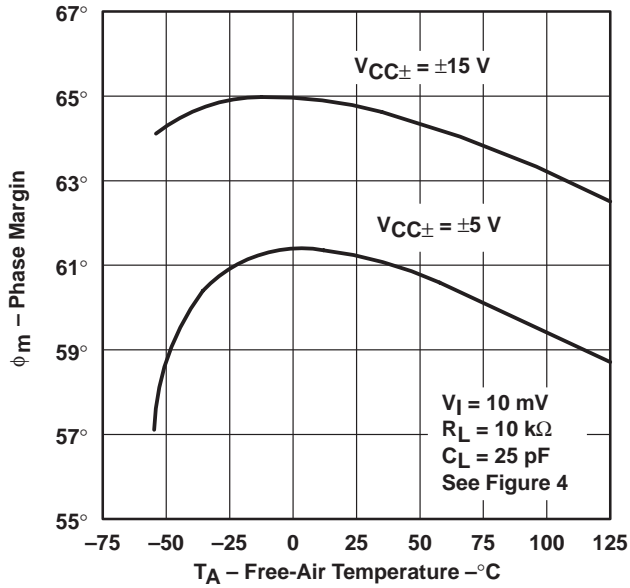

Figure 57

**VOLTAGE-FOLLOWER
 SMALL-SIGNAL
 PULSE RESPONSE**

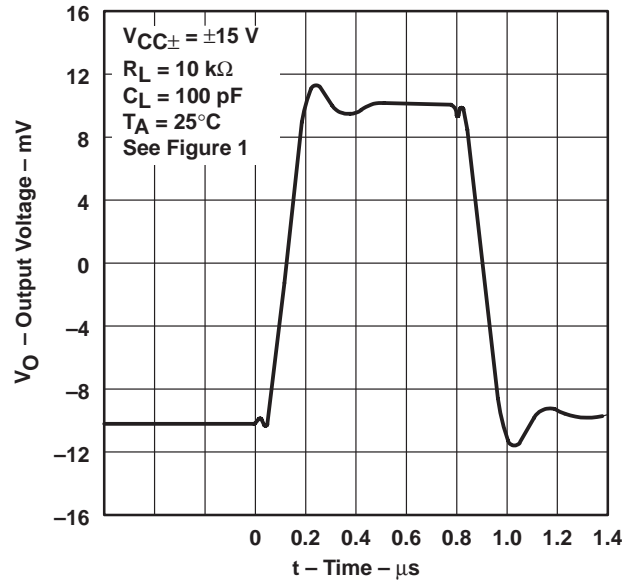

Figure 58

**VOLTAGE-FOLLOWER
 LARGE-SIGNAL
 PULSE RESPONSE**

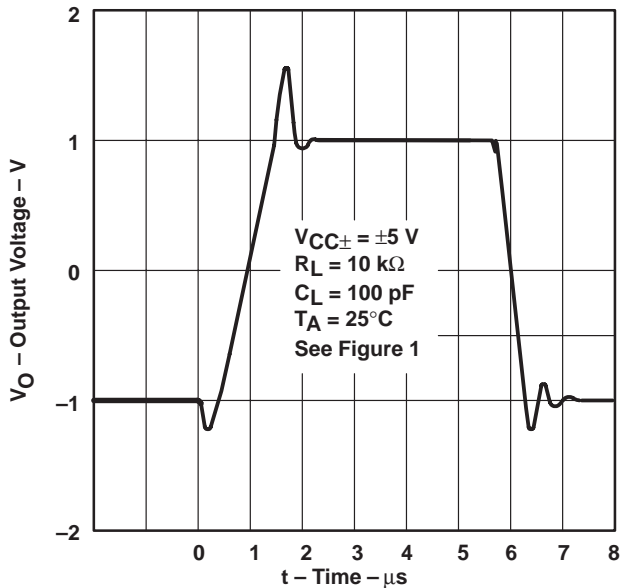

Figure 59

**VOLTAGE-FOLLOWER
 LARGE-SIGNAL
 PULSE RESPONSE**

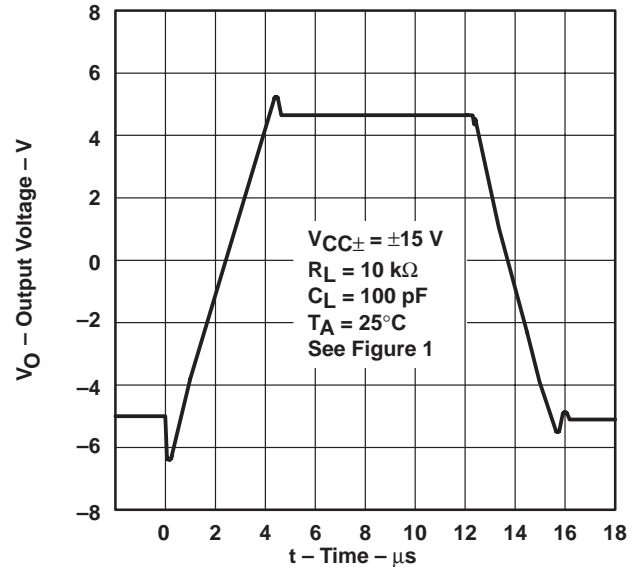

Figure 60

† Data at high and low temperatures are applicable only within the recommended operating free-air temperature ranges of the various devices.

APPLICATION INFORMATION

input characteristics

The TL03x and TL03xA are specified with a minimum and a maximum input voltage that, if exceeded at either input, could cause the device to malfunction.

Due to the extremely high input impedance and resulting low bias-current requirements, the TL03x and TL03xA are well suited for low-level signal processing; however, leakage currents on printed circuit boards and sockets easily can exceed bias current requirements and cause degradation in system performance. It is a good practice to include guard rings around inputs (see Figure 61). These guard rings should be driven from a low-impedance source at the same voltage level as the common-mode input.

Unused amplifiers should be connected as grounded unity-gain followers to avoid oscillation.

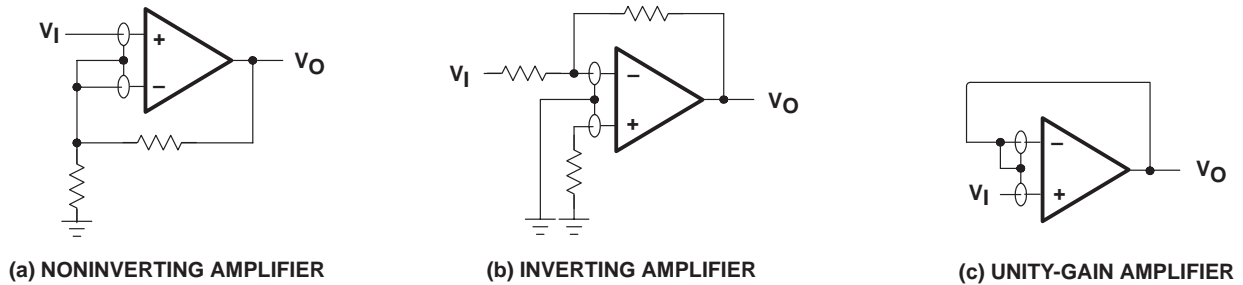

Figure 61. Use of Guard Rings

TL03x, TL03xA, TL03xY ENHANCED-JFET LOW-POWER LOW-OFFSET OPERATIONAL AMPLIFIERS

SLOS180B – FEBRUARY 1997 – REVISED FEBRUARY 1999

APPLICATION INFORMATION

output characteristics

All operating characteristics (except bandwidth and phase margin) are specified with 100-pF load capacitance. The TL03x and TL03xA drive higher capacitive loads; however, as the load capacitance increases, the resulting response pole occurs at lower frequencies, thereby causing ringing, peaking, or even oscillation. The value of the load capacitance at which oscillation occurs varies with production lots. If an application appears to be sensitive to oscillation due to load capacitance, adding a small resistance in series with the load should alleviate the problem (see Figure 63). Capacitive loads of 1000 pF and larger can be driven if enough resistance is added in series with the output (see Figure 62).

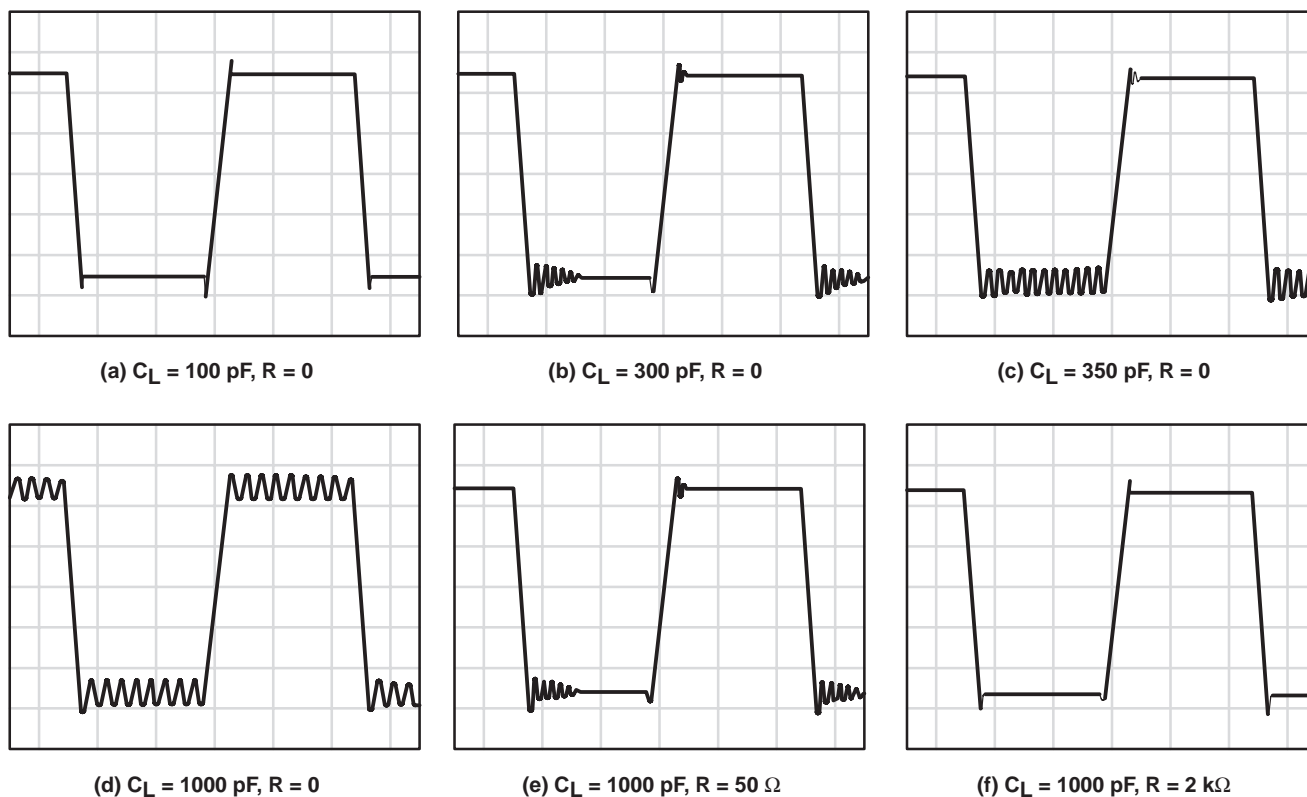
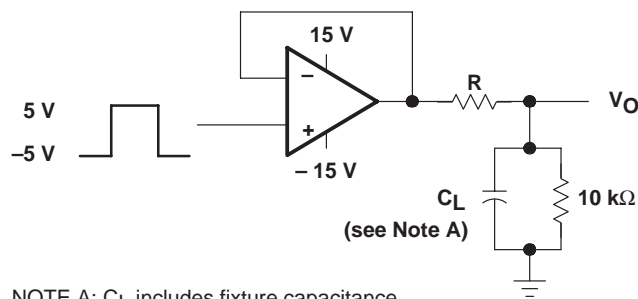

Figure 62. Effect of Capacitive Loads



NOTE A: C_L includes fixture capacitance.

Figure 63. Test Circuit for Output Characteristics

APPLICATION INFORMATION

high-Q notch filter

In general, Texas Instruments enhanced-JFET operational amplifiers serve as excellent filters. The circuit in Figure 64 provides a narrow notch at a specific frequency. Notch filters are designed to eliminate frequencies that are interfering with the operation of an application. For this filter, the center frequency can be calculated as:

$$f_0 = \frac{1}{2\pi \times R1 \times C1}$$

With the resistors and capacitors shown in Figure 64, the center frequency is 1 kHz. $C1 = C3 = C2 + 2$ and $R1 = R3 = 2 \times R2$. The center frequency can be modified by varying these values. When adjusting the center frequency, ensure that the operational amplifier has sufficient gain at the frequency required.

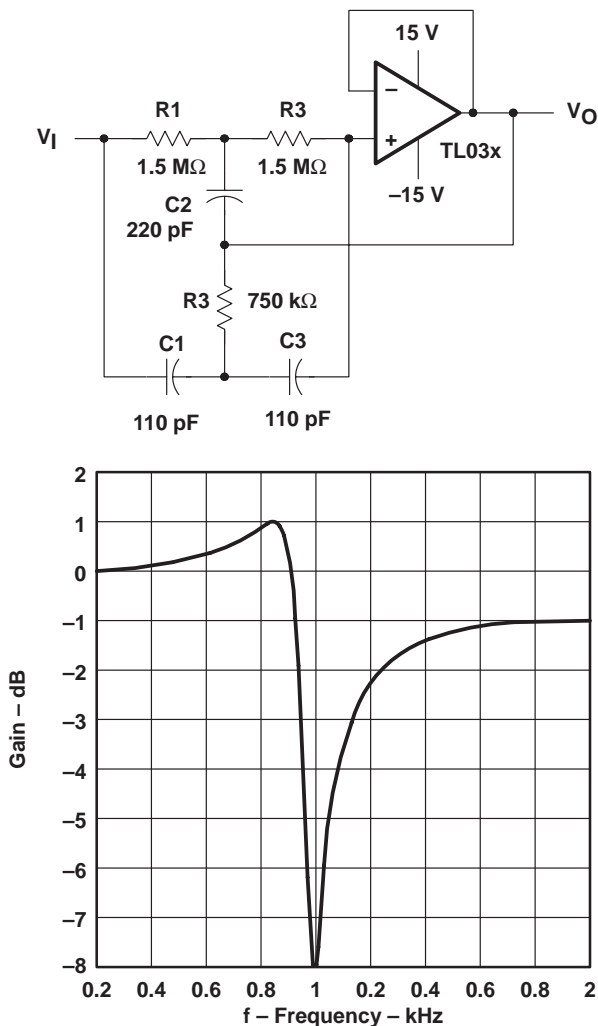

Figure 64. High-Q Notch Filter

TL03x, TL03xA, TL03xY ENHANCED-JFET LOW-POWER LOW-OFFSET OPERATIONAL AMPLIFIERS

SLOS180B – FEBRUARY 1997 – REVISED FEBRUARY 1999

APPLICATION INFORMATION

transimpedance amplifier

The low-power precision TL03x allows accurate measurement of low currents. The high input impedance and low offset voltage of the TL03xA greatly simplify the design of a transimpedance amplifier. At room temperature, this design achieves 10-bit accuracy with an error of less than 1/2 LSB.

Assuming that R2 is much less than R1 and ignoring error terms, the output voltage can be expressed as:

$$V_O = -I_{IN} \times R_F \left(\frac{R_1 + R_2}{R_2} \right)$$

Using the resistor values shown in the schematic for a 1-nA input current, the output voltage equals -0.1 V. If the V_O limit for the TL03xA is measured at ± 12 V, the maximum input current for these resistor values is ± 120 nA. Similarly, one LSB on a 10-bit scale corresponds to 12 mV of output voltage, or 120 pA of input current.

The following equation shows the effect of input offset voltage and input bias current on the output voltage:

$$V_O = - \left[V_{IO} + R_F (I_{IO} + I_{IB}) \right] \left(\frac{R_1 + R_2}{R_2} \right)$$

If the application requires input protection for the transimpedance amplifier, do not use standard PN diodes. Instead, use low-leakage Siliconix SN4117 JFETs (or equivalent) connected as diodes across the TL03xA inputs as shown in Figure 65.

As with all precision applications, special care must be taken to eliminate external sources of leakage and interference. Other precautions include using high-quality insulation, cleaning insulating surfaces to remove fluxes and other residue, and enclosing the application within a protective box.

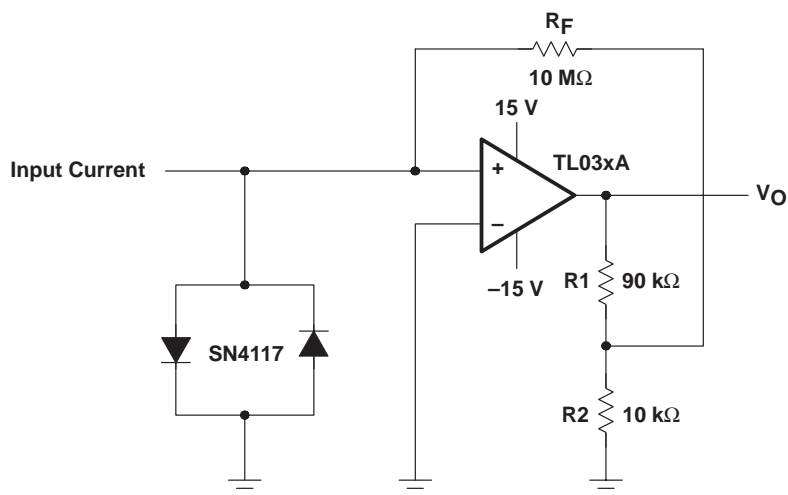

Figure 65. Transimpedance Amplifier

APPLICATION INFORMATION

4-mA to 20-mA current loops

Often, information from an analog sensor must be sent over a distance to the receiving circuitry. For many applications, the most feasible method involves converting voltage information to a current before transmission. The following circuits give two variations of low-power current loops. The circuit in Figure 66 requires three wires from the transmitting to receiving circuitry, while the second variation in Figure 67 requires only two wires, but includes an extra integrated circuit. Both circuits benefit from the high input impedance of the TL03xA because many inexpensive sensors do not have low output impedance.

Assuming that the voltage at the noninverting input of the TL03xA is zero, the following equation determines the output current:

$$I_O = V_I \left(\frac{R_3}{R_1 \times R_S} \right) + 5V \left(\frac{R_3}{R_2 \times R_S} \right) = 0.16 \times V_I + 4\text{mA}$$

The circuits presently provide 4-mA to 20-mA output current for an input voltage of 0 to 100 mV. By modifying R1, R2, and R3, the input voltage range or the output current range can be adjusted.

Including the offset voltage of the operational amplifier in the above equation clearly illustrates why the low offset TL03xA was chosen:

$$\begin{aligned} I_O &= V_I \left(\frac{R_3}{R_1 \times R_S} \right) + 5V \left(\frac{R_3}{R_2 \times R_S} \right) - V_I \left(\frac{R_3}{R_1 \times R_S} + \frac{R_3}{R_2 \times R_S} + \frac{R_1}{R_S} \right) \\ &= 0.16 \times V_I + 4\text{mA} - 0.17 \times V_I \end{aligned}$$

For example, an offset voltage of 1 mV decreases the output current by 0.17 mA.

Due to the low power consumption of the TL03xA, both circuits have at least 2 mA available to drive the actual sensor from the 5-V reference node.

TL03x, TL03xA, TL03xY
ENHANCED-JFET LOW-POWER LOW-OFFSET
OPERATIONAL AMPLIFIERS

SLOS180B – FEBRUARY 1997 – REVISED FEBRUARY 1999

4-mA to 20-mA current loops (continued)

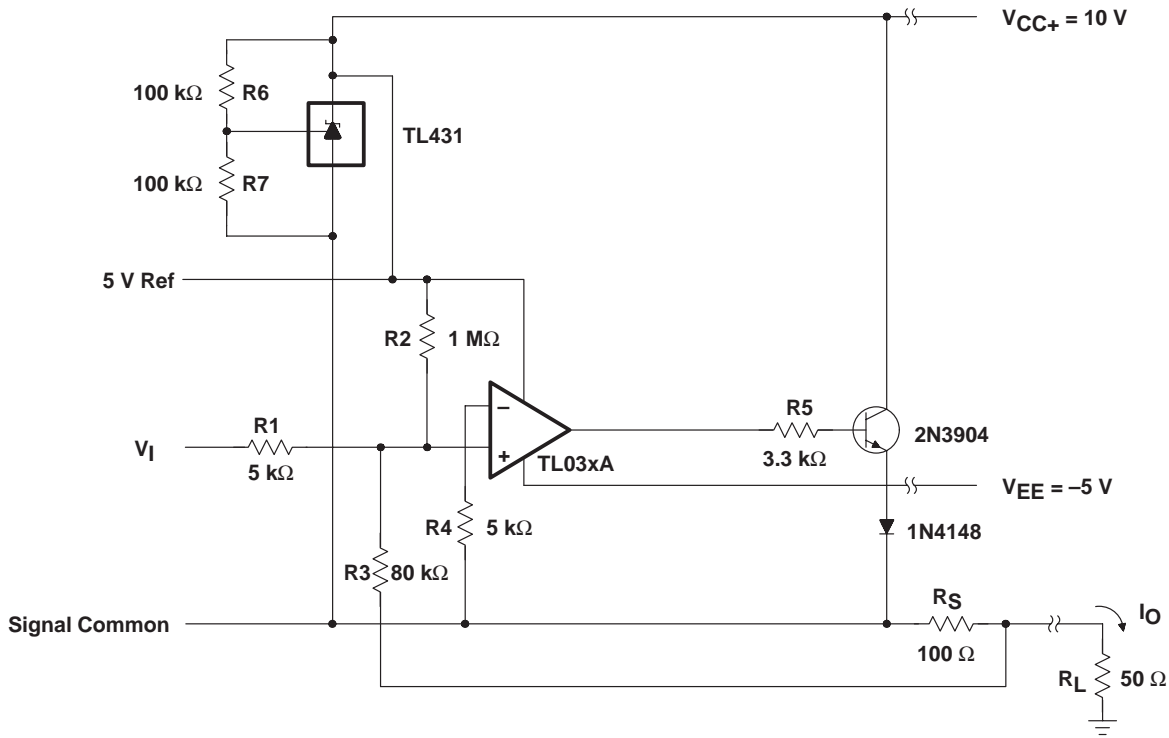

Figure 66. Three-Wire 4-mA to 20-mA Current Loop

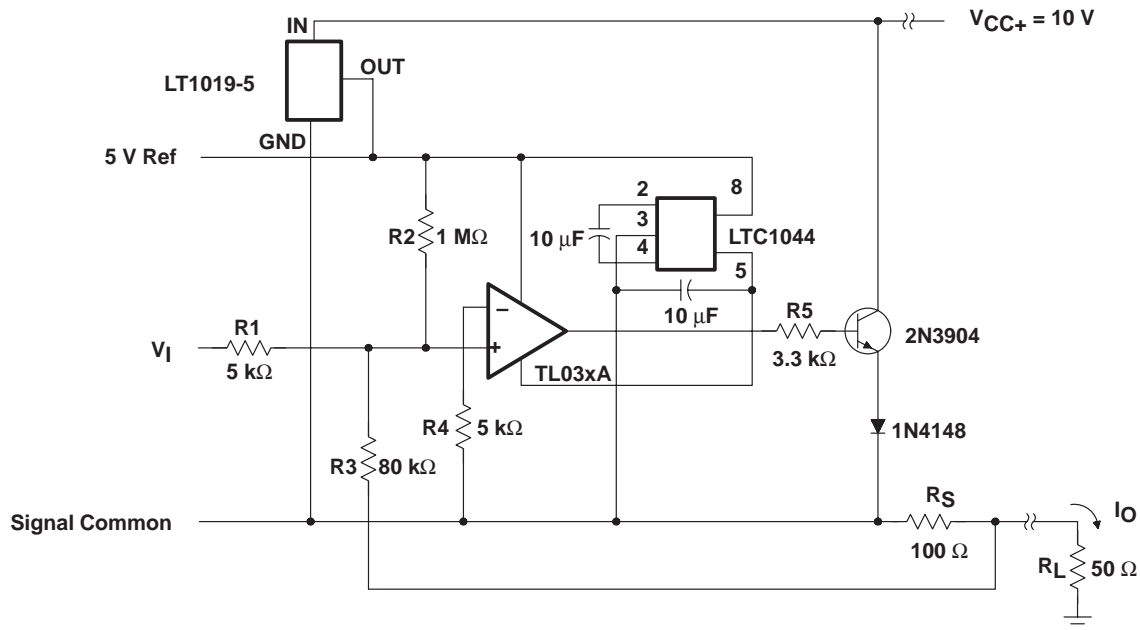

Figure 67. Two-Wire 4-mA to 20-mA Current Loop

APPLICATION INFORMATION

low-level light-detector preamplifier

Applications that need to detect small currents require high input-impedance operational amplifiers; otherwise, the bias currents of the operational amplifier camouflage the current being monitored. Phototransistors provide a current that is proportional to the light reaching the transistor. The TL03x allows even the small currents resulting from low-level light to be detected.

In Figure 68, if there is no light, the phototransistor is off and the output is high. As light is detected, the operational amplifier output begins pulling low. Adjusting R4 both compensates for offset voltage of the amplifier and adjusts the point of light detection by the amplifier.

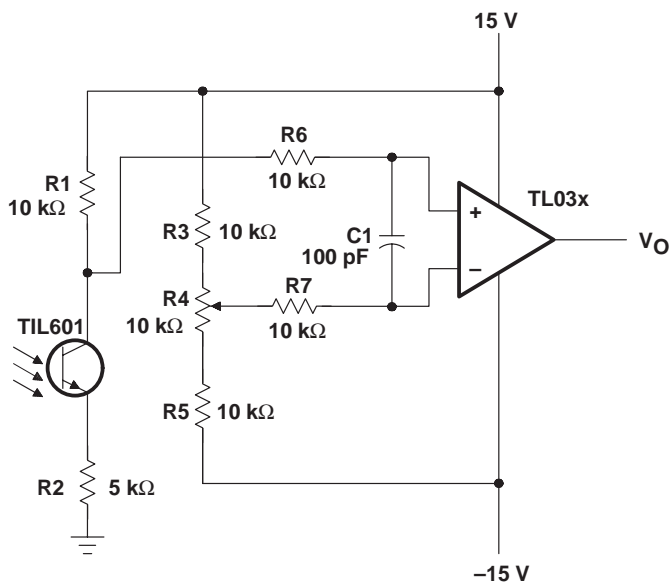

Figure 68. Low-Level Light-Detector Preamplifier

TL03x, TL03xA, TL03xY ENHANCED-JFET LOW-POWER LOW-OFFSET OPERATIONAL AMPLIFIERS

SLOS180B – FEBRUARY 1997 – REVISED FEBRUARY 1999

APPLICATION INFORMATION

audio-distribution amplifier

This audio-distribution amplifier (see Figure 69) feeds the input signal to three separate output channels. U1A amplifies the input signal with a gain of 10, while U1B, U1C, and U1D serve as buffers to the output channels. The gain response of this circuit is very flat from 20 Hz to 20 kHz. The TL03x allows quick response to the input signal while maintaining low power consumption.

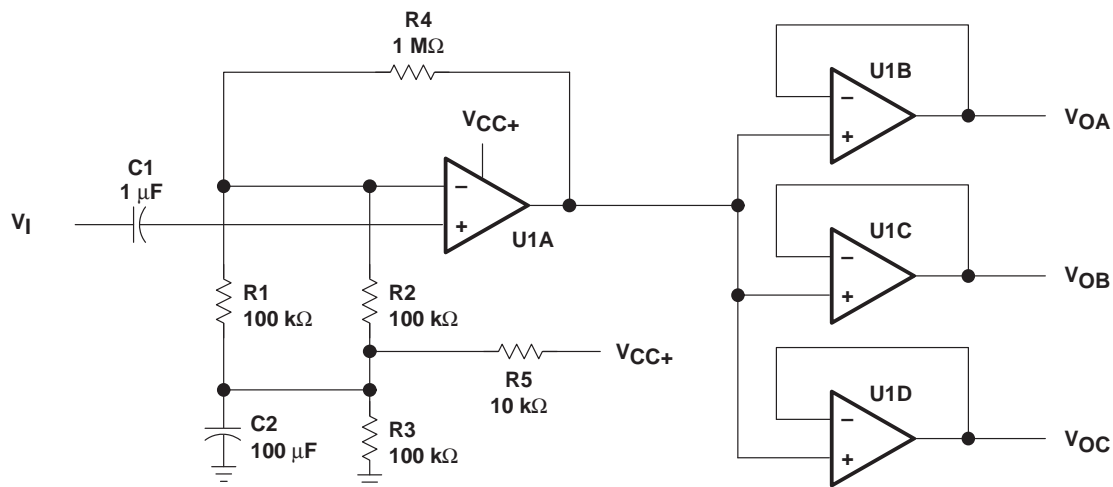

NOTE A: U1A through U1D = TL03x; $V_{CC+} = 5$ V.

Figure 69. Audio-Distribution Amplifier Circuit

APPLICATION INFORMATION

instrumentation amplifier with linear gain adjust

The low offset voltage and low power consumption of the TL03x provide an accurate but inexpensive instrumentation amplifier (see Figure 70). This particular configuration offers the advantage that the gain can be linearly set by one resistor:

$$V_O = \frac{R_6}{R_5} \times (V_B - V_A)$$

Adjusting R6 varies the gain. The value of R6 always should be greater than, or equal to, the value of R5 to ensure stability. The disadvantage of this instrumentation amplifier topology is the high degree of CMRR degradation resulting from mismatches between R1, R2, R3, and R4. For this reason, these four resistors should be 0.1%-tolerance resistors.

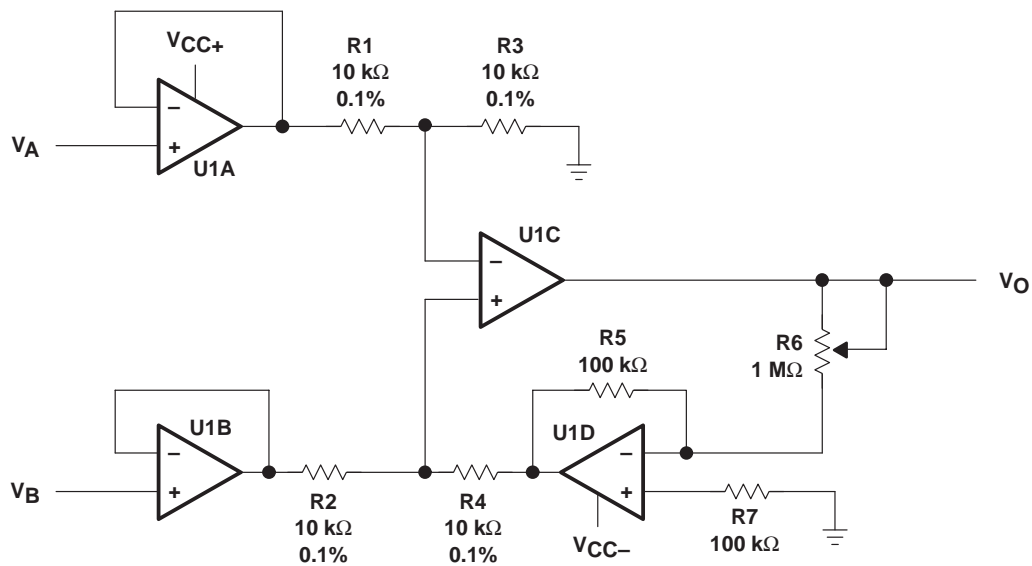

NOTE A: U1A through U1D = TL03x; VCC± = ±15 V.

Figure 70. Instrumentation Amplifier With Linear Gain-Adjust Circuit

IMPORTANT NOTICE

Texas Instruments and its subsidiaries (TI) reserve the right to make changes to their products or to discontinue any product or service without notice, and advise customers to obtain the latest version of relevant information to verify, before placing orders, that information being relied on is current and complete. All products are sold subject to the terms and conditions of sale supplied at the time of order acknowledgement, including those pertaining to warranty, patent infringement, and limitation of liability.

TI warrants performance of its semiconductor products to the specifications applicable at the time of sale in accordance with TI's standard warranty. Testing and other quality control techniques are utilized to the extent TI deems necessary to support this warranty. Specific testing of all parameters of each device is not necessarily performed, except those mandated by government requirements.

CERTAIN APPLICATIONS USING SEMICONDUCTOR PRODUCTS MAY INVOLVE POTENTIAL RISKS OF DEATH, PERSONAL INJURY, OR SEVERE PROPERTY OR ENVIRONMENTAL DAMAGE ("CRITICAL APPLICATIONS"). TI SEMICONDUCTOR PRODUCTS ARE NOT DESIGNED, AUTHORIZED, OR WARRANTED TO BE SUITABLE FOR USE IN LIFE-SUPPORT DEVICES OR SYSTEMS OR OTHER CRITICAL APPLICATIONS. INCLUSION OF TI PRODUCTS IN SUCH APPLICATIONS IS UNDERSTOOD TO BE FULLY AT THE CUSTOMER'S RISK.

In order to minimize risks associated with the customer's applications, adequate design and operating safeguards must be provided by the customer to minimize inherent or procedural hazards.

TI assumes no liability for applications assistance or customer product design. TI does not warrant or represent that any license, either express or implied, is granted under any patent right, copyright, mask work right, or other intellectual property right of TI covering or relating to any combination, machine, or process in which such semiconductor products or services might be or are used. TI's publication of information regarding any third party's products or services does not constitute TI's approval, warranty or endorsement thereof.