

# TL05x, TL05xA ENHANCED-JFET LOW-OFFSET OPERATIONAL AMPLIFIERS

SLOS178A – FEBRUARY 1997 - REVISED FEBRUARY 2003

- Direct Upgrades to TL07x and TL08x BiFET Operational Amplifiers
- Faster Slew Rate (20 V/ $\mu$ s Typ) Without Increased Power Consumption
- On-Chip Offset-Voltage Trimming for Improved DC Performance and Precision Grades Are Available (1.5 mV, TL051A)

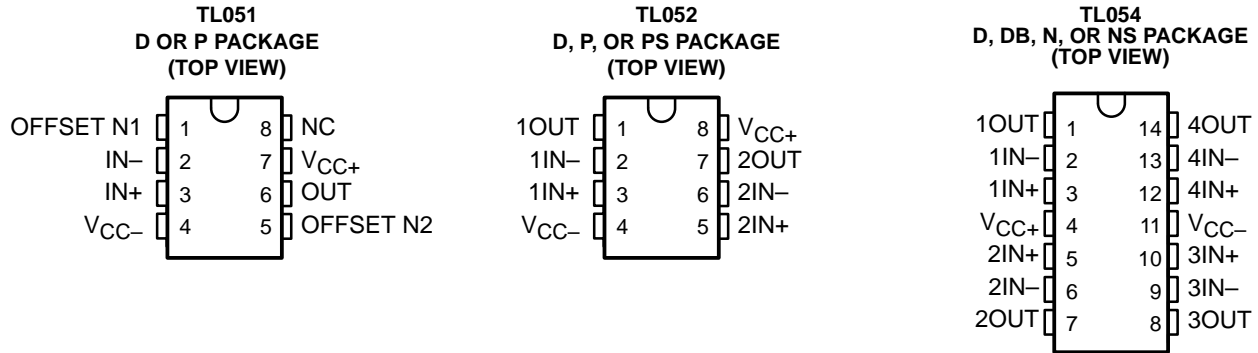

## description/ordering information

The TL05x series of JFET-input operational amplifiers offers improved dc and ac characteristics over the TL07x and TL08x families of BiFET operational amplifiers. On-chip Zener trimming of offset voltage yields precision grades as low as 1.5 mV (TL051A) for greater accuracy in dc-coupled applications. Texas Instruments improved BiFET process and optimized designs also yield improved bandwidth and slew rate without increased power consumption. The TL05x devices are pin-compatible with the TL07x and TL08x and can be used to upgrade existing circuits or for optimal performance in new designs.

BiFET operational amplifiers offer the inherently higher input impedance of the JFET-input transistors, without sacrificing the output drive associated with bipolar amplifiers. This makes them better suited for interfacing with high-impedance sensors or very low-level ac signals. They also feature inherently better ac response than bipolar or CMOS devices having comparable power consumption.

The TL05x family was designed to offer higher precision and better ac response than the TL08x, with the low noise floor of the TL07x. Designers requiring significantly faster ac response or ensured lower noise should consider the Excalibur TLE208x and TLE207x families of BiFET operational amplifiers.

Because BiFET operational amplifiers are designed for use with dual power supplies, care must be taken to observe common-mode input voltage limits and output swing when operating from a single supply. DC biasing of the input signal is required, and loads should be terminated to a virtual-ground node at mid-supply. Texas Instruments TLE2426 integrated virtual ground generator is useful when operating BiFET amplifiers from single supplies.

The TL05x are fully specified at  $\pm 15$  V and  $\pm 5$  V. For operation in low-voltage and/or single-supply systems, Texas Instruments LinCMOS families of operational amplifiers (TLC-prefix) are recommended. When moving from BiFET to CMOS amplifiers, particular attention should be paid to the slew rate and bandwidth requirements, and also the output loading.



Please be aware that an important notice concerning availability, standard warranty, and use in critical applications of Texas Instruments semiconductor products and disclaimers thereto appears at the end of this data sheet.

PRODUCTION DATA information is current as of publication date. Products conform to specifications per the terms of Texas Instruments standard warranty. Production processing does not necessarily include testing of all parameters.

 **TEXAS  
INSTRUMENTS**

POST OFFICE BOX 655303 • DALLAS, TEXAS 75265

Copyright © 2003, Texas Instruments Incorporated

**TL05x, TL05xA**  
**ENHANCED-JFET LOW-OFFSET**  
**OPERATIONAL AMPLIFIERS**

SLOS178A – FEBRUARY 1997 - REVISED FEBRUARY 2003

**ORDERING INFORMATION**

<b>T<sub>A</sub></b>	<b>V<sub>IOMAX</sub> AT 25°C</b>	<b>PACKAGE†</b>		<b>ORDERABLE PART NUMBER</b>	<b>TOP-SIDE MARKING</b>
0°C to 70°C	800 μV	PDIP (P)	Tube of 50	TL051ACP	TL051ACP
				TL052ACP	TL052ACP
		SOIC (D)	Tube of 75	TL051ACD	051AC
			Tube of 75	TL052ACD	052AC
			Reel of 2500	TL052ACDR	
		1.5 mV	PDIP (P)	Tube of 50	TL051CP
				TL052CP	TL052CP
	PDIP (N)		Tube of 25	TL054ACN	TL054ACN
			SOIC (D)	Tube of 75	TL051CD
	Reel of 2500			TL051CDR	
	Tube of 75			TL052CD	TL052C
	Reel of 2500		TL052CDR		
	Tube of 50		TL054ACD	TL054C	
	Reel of 2500		TL054ACDR		
	SOP (PS)		Reel of 2000	TL052CPSR	TL052
	SSOP (DB)	Reel of 2000	TL054CDBR	TL054	
	4 mV	PDIP (N)	Tube of 25	TL054CN	TL054CN
			SOIC (D)	Tube of 50	TL054CD
		Reel of 2500		TL054CDR	
		SOP (NS)	Reel of 2000	TL054CNSR	TL054
-40°C to 85°C	800 μV	PDIP (P)	Tube of 50	TL052AIP	TL052AI
				TL052AID	052AI
		SOIC (D)	Tube of 75	TL052AID	
	Reel of 2500		TL052AIDR		
	1.5 mV	PDIP (N)	Tube of 25	TL054AIN	TL054AIN
			PDIP (P)	Tube of 50	TL051IP
				TL052IP	TL052IP
		SOIC (D)	Tube of 75	TL051ID	TL051I
			Tube of 75	TL052ID	TL052I
			Reel of 2500	TL052IDR	
			Tube of 50	TL054AID	TL054AI
		Reel of 2500	TL054AIDR		
	4 mV	PDIP (N)	Tube of 25	TL054IN	TL054IN
			SOIC (D)	Tube of 50	TL054ID
Reel of 2500		TL054IDR			

† Package drawings, standard packing quantities, thermal data, symbolization, and PCB design guidelines are available at [www.ti.com/sc/package](http://www.ti.com/sc/package).



# TL05x, TL05xA ENHANCED-JFET LOW-OFFSET OPERATIONAL AMPLIFIERS

SLOS178A – FEBRUARY 1997 - REVISED FEBRUARY 2003

symbol (each amplifier)

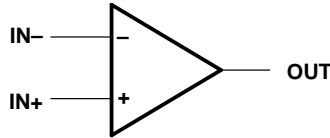

equivalent schematic (each amplifier)

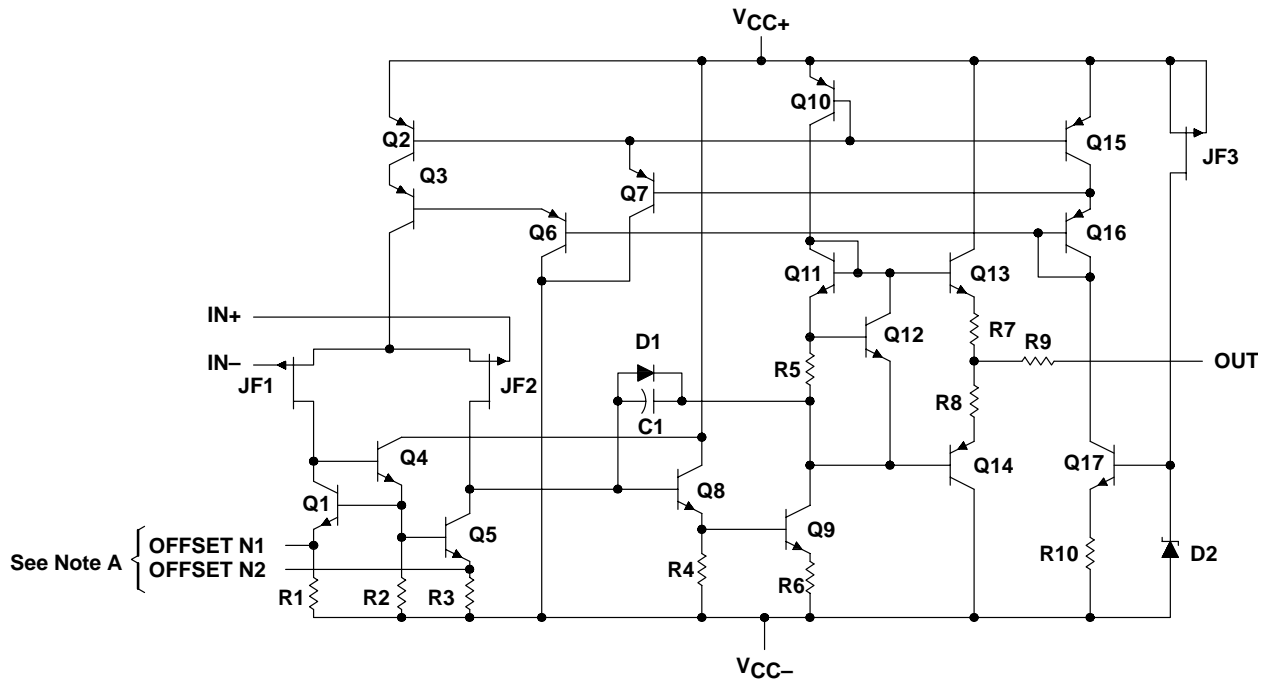

NOTE A: OFFSET N1 and OFFSET N2 are available only on the TL051x.

ACTUAL DEVICE COMPONENT COUNT†			
COMPONENT	TL051	TL052	TL054
Transistors	20	34	62
Resistors	10	19	37
Diodes	2	3	5
Capacitors	1	2	4

† These figures include all four amplifiers and all ESD, bias, and trim circuitry.

# TL05x, TL05xA ENHANCED-JFET LOW-OFFSET OPERATIONAL AMPLIFIERS

SLOS178A – FEBRUARY 1997 - REVISED FEBRUARY 2003

## absolute maximum ratings over operating free-air temperature range (unless otherwise noted)†

Supply voltage, $V_{CC+}$ (see Note 1)	18 V
Supply voltage, $V_{CC-}$ (see Note 1)	-18 V
Differential input voltage (see Note 2)	$\pm 30$ V
Input voltage range, $V_I$ (any input, see Notes 1 and 3)	$\pm 15$ V
Input current, $I_I$ (each input)	$\pm 1$ mA
Output current, $I_O$ (each output)	$\pm 80$ mA
Total current into $V_{CC+}$	160 mA
Total current out of $V_{CC-}$	160 mA
Duration of short-circuit current at (or below) 25°C	Unlimited
Package thermal impedance, $\theta_{JA}$ (see Notes 4 and 5):	
D package (8 pin)	97°C/W
D package (14 pin)	86°C/W
DB package (14 pin)	96°C/W
N package (14 pin)	80°C/W
NS package (14 pin)	76°C/W
P package (8 pin)	85°C/W
PS package (8 pin)	95°C/W
Operating virtual junction temperature, $T_J$	150°C
Lead temperature 1,6 mm (1/16inch) from case for 10 seconds	260°C
Storage temperature range	-65°C to 150°C

† Stresses beyond those listed under “absolute maximum ratings” may cause permanent damage to the device. These are stress ratings only, and functional operation of the device at these or any other conditions beyond those indicated under “recommended operating conditions” is not implied. Exposure to absolute-maximum-rated conditions for extended periods may affect device reliability.

- NOTES:
1. All voltage values, except differential voltages, are with respect to the midpoint between  $V_{CC+}$  and  $V_{CC-}$ .
  2. Differential voltages are at  $IN+$  with respect to  $IN-$ .
  3. The magnitude of the input voltage must never exceed the magnitude of the supply voltage or 15 V, whichever is less.
  4. Maximum power dissipation is a function of  $T_J(\text{max})$ ,  $\theta_{JA}$ , and  $T_A$ . The maximum allowable power dissipation at any allowable ambient temperature is  $P_D = (T_J(\text{max}) - T_A)/\theta_{JA}$ . Operating at the absolute maximum  $T_J$  of 150°C can impact reliability.
  5. The package thermal impedance is calculated in accordance with JESD 51-7.

## recommended operating conditions

		C SUFFIX		I SUFFIX		UNIT
		MIN	MAX	MIN	MAX	
$V_{CC\pm}$	Supply voltage	$\pm 5$	$\pm 15$	$\pm 5$	$\pm 15$	V
$V_{IC}$	Common-mode input voltage	$V_{CC\pm} = \pm 5$ V		-1	4	V
		$V_{CC\pm} = \pm 15$ V		-11	11	
$T_A$	Operating free-air temperature	0	70	-40	85	°C



**TL05x, TL05xA**  
**ENHANCED-JFET LOW-OFFSET**  
**OPERATIONAL AMPLIFIERS**

SLOS178A – FEBRUARY 1997 - REVISED FEBRUARY 2003

**TL051C and TL051AC electrical characteristics at specified free-air temperature**

PARAMETER	TEST CONDITIONS	T <sub>A</sub> †	TL051C, TL051AC						UNIT
			V <sub>CC±</sub> = ±5 V			V <sub>CC±</sub> = ±15 V			
			MIN	TYP	MAX	MIN	TYP	MAX	
V <sub>IO</sub> Input offset voltage		TL051C	25°C	0.75 3.5		0.59 1.5		mV	
			Full range	4.5		2.5			
		TL051AC	25°C	0.55 2.8		0.35 0.8			
			Full range	3.8		1.8			
α <sub>V<sub>IO</sub></sub> Temperature coefficient of input offset voltage‡	V <sub>O</sub> = 0, V <sub>IC</sub> = 0, R <sub>S</sub> = 50 Ω	TL051C	25°C to 70°C		8		μV/°C		
		TL051AC	25°C to 70°C		8 25				
Input offset-voltage long-term drift§		25°C	0.04		0.04		μV/mo		
I <sub>IO</sub> Input offset current	V <sub>O</sub> = 0, V <sub>IC</sub> = 0, See Figure 5	25°C	4 100		5 100		pA		
		70°C	0.02 1		0.025 1		nA		
I <sub>IB</sub> Input bias current	V <sub>O</sub> = 0, V <sub>IC</sub> = 0, See Figure 5	25°C	20 200		30 200		pA		
		70°C	0.15 4		0.2 4		nA		
V <sub>ICR</sub> Common-mode input voltage range		25°C	-1 to 4 -2.3 to 5.6		-11 to 11 -12.3 to 15.6		V		
		Full range	-1 to 4		-11 to 11				
V <sub>OM+</sub> Maximum positive peak output voltage swing	R <sub>L</sub> = 10 kΩ	25°C	3 4.2		13 13.9		V		
		Full range	3		13				
	R <sub>L</sub> = 2 kΩ	25°C	2.5 3.8		11.5 12.7				
		Full range	2.5		11.5				
V <sub>OM-</sub> Maximum negative peak output voltage swing	R <sub>L</sub> = 10 kΩ	25°C	-2.5 -3.5		-12 -13.2		V		
		Full range	-2.5		-12				
	R <sub>L</sub> = 2 kΩ	25°C	-2.3 -3.2		-11 -12				
		Full range	-2.3		-11				
A <sub>VD</sub> Large-signal differential voltage amplification¶	R <sub>L</sub> = 2 kΩ	25°C	25 59		50 105		V/mV		
		0°C	30 65		60 129				
		70°C	20 46		30 85				
r <sub>i</sub> Input resistance		25°C	10 <sup>12</sup>		10 <sup>12</sup>		Ω		
c <sub>i</sub> Input capacitance		25°C	10		12		pF		
CMRR Common-mode rejection ratio	V <sub>IC</sub> = V <sub>ICRmin</sub> , V <sub>O</sub> = 0, R <sub>S</sub> = 50 Ω	25°C	65 85		75 93		dB		
		0°C	65 84		75 92				
		70°C	65 84		75 91				
k <sub>SVR</sub> Supply-voltage rejection ratio (ΔV <sub>CC±</sub> /ΔV <sub>IO</sub> )	V <sub>O</sub> = 0, R <sub>S</sub> = 50 Ω	25°C	75 99		75 99		dB		
		0°C	75 98		75 98				
		70°C	75 97		75 97				
I <sub>CC</sub> Supply current	V <sub>O</sub> = 0, No load	25°C	2.6 3.2		2.7 3.2		mA		
		0°C	2.7 3.2		2.8 3.2				
		70°C	2.6 3.2		2.7 3.2				

† Full range is 0°C to 70°C.

‡ This parameter is tested on a sample basis for the TL051A. For other test requirements, please contact the factory. This statement has no bearing on testing or nontesting of other parameters.

§ Typical values are based on the input offset-voltage shift observed through 168 hours of operating life test at T<sub>A</sub> = 150°C, extrapolated to T<sub>A</sub> = 25°C using the Arrhenius equation, and assuming an activation energy of 0.96 eV.

¶ For V<sub>CC±</sub> = ±5 V, V<sub>O</sub> = ±2.3 V, or for V<sub>CC±</sub> = ±15 V, V<sub>O</sub> = ±10 V.



# TL05x, TL05xA ENHANCED-JFET LOW-OFFSET OPERATIONAL AMPLIFIERS

SLOS178A – FEBRUARY 1997 - REVISED FEBRUARY 2003

## TL051C and TL051AC operating characteristics at specified free-air temperature

PARAMETER	TEST CONDITIONS	T <sub>A</sub> †	TL051C, TL051AC			UNIT		
			V <sub>CC±</sub> = ±5 V		V <sub>CC±</sub> = ±15 V			
			MIN	TYP	MAX		MIN	TYP
SR+	Positive slew rate at unity gain‡	25°C	16		13 20		V/μs	
			Full range	16.4		11 22.6		
SR-	Negative slew rate at unity gain‡	25°C	15		13 18			
			Full range	16		11 19.3		
t <sub>r</sub>	R <sub>L</sub> = 2 kΩ, C <sub>L</sub> = 100 pF, See Figure 1	25°C	55		56		ns	
t <sub>f</sub>		0°C	54		55			
		70°C	63		63			
		25°C	55		57			
		0°C	54		56			
Overshoot factor		70°C	62		64			
	25°C	24		19		%		
	0°C	24		19				
70°C	24		19					
V <sub>n</sub>	Equivalent input noise voltage§	R <sub>S</sub> = 20 Ω, See Figure 3	f = 10 Hz	25°C	75		nV/√Hz	
V <sub>N(PP)</sub>			f = 1 kHz	25°C	18 30			
		Peak-to-peak equivalent input noise voltage	f = 10 Hz to 10 kHz	25°C	4		μV	
I <sub>n</sub>	Equivalent input noise current	f = 1 kHz	25°C	0.01		pA/√Hz		
THD	Total harmonic distortion¶	R <sub>S</sub> = 1 kΩ, R <sub>L</sub> = 2 kΩ, f = 1 kHz	25°C	0.003		%		
B <sub>1</sub>	Unity-gain bandwidth	V <sub>I</sub> = 10 mV, C <sub>L</sub> = 25 pF, R <sub>L</sub> = 2 kΩ, See Figure 4	25°C	3		3.1		MHz
			0°C	3.2		3.3		
			70°C	2.7		2.8		
φ <sub>m</sub>	Phase margin at unity gain	V <sub>I</sub> = 10 mV, C <sub>L</sub> = 25 pF, R <sub>L</sub> = 2 kΩ, See Figure 4	25°C	59		62		deg
			0°C	58		62		
			70°C	59		62		

† Full range is 0°C to 70°C.

‡ For V<sub>CC±</sub> = ±5 V, V<sub>I(PP)</sub> = ±1 V; for V<sub>CC±</sub> = ±15 V, V<sub>I(PP)</sub> = ±5 V.

§ This parameter is tested on a sample basis for the TL051A. For other test requirements, please contact the factory. This statement has no bearing on testing or nontesting of other parameters.

¶ For V<sub>CC±</sub> = ±5 V, V<sub>O(RMS)</sub> = 1 V; for V<sub>CC±</sub> = ±15 V, V<sub>O(RMS)</sub> = 6 V.



**TL05x, TL05xA**  
**ENHANCED-JFET LOW-OFFSET**  
**OPERATIONAL AMPLIFIERS**

SLOS178A – FEBRUARY 1997 - REVISED FEBRUARY 2003

**TL051I and TL051AI electrical characteristics at specified free-air temperature**

PARAMETER	TEST CONDITIONS		T <sub>A</sub> †	TL051I, TL051AI						UNIT
				V <sub>CC±</sub> = ±5 V			V <sub>CC±</sub> = ±15 V			
				MIN	TYP	MAX	MIN	TYP	MAX	
V <sub>IO</sub> Input offset voltage		TL051I	25°C	0.75   3.5		0.59   1.5		mV		
			Full range	5.3		3.3				
			TL051AI	25°C	0.55   2.8		0.35   0.8			
				Full range	4.6		2.6			
α <sub>V<sub>IO</sub></sub> Temperature coefficient of input offset voltage‡		TL051I	25°C to 85°C	7		8		μV/°C		
			TL051AI	25°C to 85°C	8		8   25			
Input offset-voltage long-term drift§			25°C	0.04		0.04		μV/mo		
I <sub>IO</sub> Input offset current	V <sub>O</sub> = 0, V <sub>IC</sub> = 0, See Figure 5		25°C	4   100		5   100		pA		
			85°C	0.06   10		0.07   10		nA		
I <sub>IB</sub> Input bias current	V <sub>O</sub> = 0, V <sub>IC</sub> = 0, See Figure 5		25°C	20   200		30   200		pA		
			85°C	0.6   20		0.7   20		nA		
V <sub>ICR</sub> Common-mode input voltage range			25°C	-1 to 4   -2.3 to 5.6		-11 to 11   -12.3 to 15.6		V		
			Full range	-1 to 4		-11 to 11				
V <sub>OM+</sub> Maximum positive peak output voltage swing	R <sub>L</sub> = 10 kΩ		25°C	3   4.2		13   13.9		V		
			Full range	3		13				
	R <sub>L</sub> = 2 kΩ	25°C	2.5   3.8		11.5   12.7					
		Full range	2.5		11.5					
V <sub>OM-</sub> Maximum negative peak output voltage swing	R <sub>L</sub> = 10 kΩ		25°C	-2.5   -3.5		-12   -13.2		V		
			Full range	-2.5		-12				
	R <sub>L</sub> = 2 kΩ	25°C	-2.3   -3.2		-11   -12					
		Full range	-2.3		-11					
A <sub>VD</sub> Large-signal differential voltage amplification¶	R <sub>L</sub> = 2 kΩ		25°C	25   59		50   105		V/mV		
			-40°C	30   74		60   145				
			85°C	20   43		30   76				
r <sub>i</sub> Input resistance			25°C	10 <sup>12</sup>		10 <sup>12</sup>		Ω		
c <sub>i</sub> Input capacitance			25°C	10		12		pF		
CMRR    Common-mode rejection ratio	V <sub>IC</sub> = V <sub>ICRmin</sub> , V <sub>O</sub> = 0, R <sub>S</sub> = 50 Ω		25°C	65   85		75   93		dB		
			-40°C	65   83		75   90				
			85°C	65   84		75   93				
k <sub>SVR</sub> Supply-voltage rejection ratio (ΔV <sub>CC±</sub> /ΔV <sub>IO</sub> )	V <sub>O</sub> = 0, R <sub>S</sub> = 50 Ω		25°C	75   99		75   99		dB		
			-40°C	75   98		75   98				
			85°C	75   99		75   99				
I <sub>CC</sub> Supply current	V <sub>O</sub> = 0, No load		25°C	2.6   3.2		2.7   3.2		mA		
			-40°C	2.4   3.2		2.6   3.2				
			85°C	2.5   3.2		2.6   3.2				

† Full range is -40°C to 85°C

‡ This parameter is tested on a sample basis for the TL051A. For other test requirements, please contact the factory. This statement has no bearing on testing or nontesting of other parameters.

§ Typical values are based on the input offset-voltage shift observed through 168 hours of operating life test at T<sub>A</sub> = 150°C, extrapolated to T<sub>A</sub> = 25°C using the Arrhenius equation, and assuming an activation energy of 0.96 eV.

¶ For V<sub>CC±</sub> = ±5 V, V<sub>O</sub> = ±2.3 V, or for V<sub>CC±</sub> = ±15 V, V<sub>O</sub> = ±10 V.



# TL05x, TL05xA ENHANCED-JFET LOW-OFFSET OPERATIONAL AMPLIFIERS

SLOS178A – FEBRUARY 1997 - REVISED FEBRUARY 2003

## TL051I and TL051AI operating characteristics at specified free-air temperature

PARAMETER	TEST CONDITIONS	T <sub>A</sub> †	TL051I, TL051AI						UNIT
			V <sub>CC±</sub> = ±5 V			V <sub>CC±</sub> = ±15 V			
			MIN	TYP	MAX	MIN	TYP	MAX	
SR+	Positive slew rate at unity gain‡	R <sub>L</sub> = 2 kΩ, C <sub>L</sub> = 100 pF, See Figure 1	25°C	16			13	20	V/μs
			Full range				11		
SR-	Negative slew rate at unity gain‡	R <sub>L</sub> = 2 kΩ, C <sub>L</sub> = 100 pF, See Figure 1	25°C	15			13	18	
			Full range				11		
t <sub>r</sub>	Rise time	V <sub>I(PP)</sub> = ±10 mV, R <sub>L</sub> = 2 kΩ, C <sub>L</sub> = 100 pF, See Figures 1 and 2	25°C	55			56		ns
t <sub>f</sub>	Fall time		-40°C	52			53		
			85°C	64			65		
			25°C	55			57		
			-40°C	51			53		
Overshoot factor			85°C	64			65		
		25°C	24			19		%	
		-40°C	24			19			
V <sub>n</sub>	Equivalent input noise voltage§	R <sub>S</sub> = 20 Ω, See Figure 3	f = 10 Hz	75			75		nV/√Hz
			f = 1 kHz	18			18	30	
V <sub>N(PP)</sub>	Peak-to-peak equivalent input noise voltage	f = 10 Hz to 10 kHz	25°C	4			4		μV
I <sub>n</sub>	Equivalent input noise current	f = 1 kHz	25°C	0.01			0.01		pA/√Hz
THD	Total harmonic distortion¶	R <sub>S</sub> = 1 kΩ, R <sub>L</sub> = 2 kΩ, f = 1 kHz	25°C	0.003			0.003		%
B <sub>1</sub>	Unity-gain bandwidth	V <sub>I</sub> = 10 mV, C <sub>L</sub> = 25 pF, R <sub>L</sub> = 2 kΩ, See Figure 4	25°C	3			3.1		MHz
			-40°C	3.5			3.6		
			85°C	2.6			2.7		
φ <sub>m</sub>	Phase margin at unity gain	V <sub>I</sub> = 10 mV, C <sub>L</sub> = 25 pF, R <sub>L</sub> = 2 kΩ, See Figure 4	25°C	59			62		deg
			-40°C	58			61		
			85°C	59			62		

† Full range is -40°C to 85°C.

‡ For V<sub>CC±</sub> = ±5 V, V<sub>I(PP)</sub> = ±1 V; for V<sub>CC±</sub> = ±15 V, V<sub>I(PP)</sub> = ±5 V.

§ This parameter is tested on a sample basis for the TL051A. For other test requirements, please contact the factory. This statement has no bearing on testing or nontesting of other parameters.

¶ For V<sub>CC±</sub> = ±5 V, V<sub>O(RMS)</sub> = 1 V; for V<sub>CC±</sub> = ±15 V, V<sub>O(RMS)</sub> = 6 V.



# TL05x, TL05xA ENHANCED-JFET LOW-OFFSET OPERATIONAL AMPLIFIERS

SLOS178A – FEBRUARY 1997 - REVISED FEBRUARY 2003

## TL052C and TL052AC electrical characteristics at specified free-air temperature

PARAMETER	TEST CONDITIONS		T <sub>A</sub> †	TL052C, TL052AC						UNIT
				V <sub>CC±</sub> = ±5 V			V <sub>CC±</sub> = ±15 V			
				MIN	TYP	MAX	MIN	TYP	MAX	
V <sub>IO</sub> Input offset voltage		TL052C	25°C	0.73 3.5		0.65 1.5		mV		
			Full range	4.5		2.5				
			TL052AC	25°C	0.51 2.8		0.4 0.8			
				Full range	3.8		1.8			
α <sub>V<sub>IO</sub></sub> Temperature coefficient of input offset voltage‡		TL052C	25°C to 70°C	8		8		μV/°C		
			TL052AC	25°C to 70°C	8		6 25			
Input offset-voltage long-term drift§	V <sub>O</sub> = 0, R <sub>S</sub> = 50 Ω	V <sub>IC</sub> = 0,	25°C	0.04		0.04		μV/mo		
I <sub>IO</sub> Input offset current	V <sub>O</sub> = 0, See Figure 5	V <sub>IC</sub> = 0,	25°C	4 100		5 100		pA		
			70°C	0.02 1		0.025 1		nA		
I <sub>IB</sub> Input bias current	V <sub>O</sub> = 0, See Figure 5	V <sub>IC</sub> = 0,	25°C	20 200		30 200		pA		
			70°C	0.15 4		0.2 4		nA		
V <sub>ICR</sub> Common-mode input voltage range			25°C	-1 to 4 -2.3 to 5.6		-11 to 11 -12.3 to 15.6		V		
			Full range	-1 to 4		-11 to 11				
V <sub>OM+</sub> Maximum positive peak output voltage swing	R <sub>L</sub> = 10 kΩ		25°C	3 4.2		13 13.9		V		
			Full range	3		13				
	R <sub>L</sub> = 2 kΩ	25°C	2.5 3.8		11.5 12.7					
		Full range	2.5		11.5					
V <sub>OM-</sub> Maximum negative peak output voltage swing	R <sub>L</sub> = 10 kΩ		25°C	-2.5 -3.5		-12 -13.2		V		
			Full range	-2.5		-12				
	R <sub>L</sub> = 2 kΩ	25°C	-2.3 -3.2		-11 -12					
		Full range	-2.3		-11					
A <sub>VD</sub> Large-signal differential voltage amplification¶	R <sub>L</sub> = 2 kΩ		25°C	25 59		50 105		V/mV		
			0°C	30 65		60 129				
			70°C	20 46		30 85				
r <sub>i</sub> Input resistance			25°C	10 <sup>12</sup>		10 <sup>12</sup>		Ω		
c <sub>i</sub> Input capacitance			25°C	10		12		pF		
CMRR Common-mode rejection ratio	V <sub>IC</sub> = V <sub>ICRmin</sub> , V <sub>O</sub> = 0,	R <sub>S</sub> = 50 Ω	25°C	65 85		75 93		dB		
			0°C	65 84		75 92				
			70°C	65 84		75 91				

† Full range is 0°C to 70°C.

‡ This parameter is tested on a sample basis. For other test requirements, please contact the factory. This statement has no bearing on testing or nontesting of other parameters.

§ Typical values are based on the input offset-voltage shift observed through 168 hours of operating life test at T<sub>A</sub> = 150°C, extrapolated to T<sub>A</sub> = 25°C using the Arrhenius equation, and assuming an activation energy of 0.96 eV.

¶ For V<sub>CC±</sub> = ±5 V, V<sub>O</sub> = ±2.3 V; at V<sub>CC±</sub> = ±15 V, V<sub>O</sub> = ±10 V.



# TL05x, TL05xA ENHANCED-JFET LOW-OFFSET OPERATIONAL AMPLIFIERS

SLOS178A – FEBRUARY 1997 - REVISED FEBRUARY 2003

## TL052C and TL052AC electrical characteristics at specified free-air temperature (continued)

PARAMETER	TEST CONDITIONS	T <sub>A</sub>	TL052C, TL052AC						UNIT	
			V <sub>CC±</sub> = ±5 V			V <sub>CC±</sub> = ±15 V				
			MIN	TYP	MAX	MIN	TYP	MAX		
k <sub>SVR</sub>	Supply-voltage rejection ratio (ΔV <sub>CC±</sub> /ΔV <sub>IO</sub> )	V <sub>O</sub> = 0, R <sub>S</sub> = 50 Ω	25°C	75	99		75	99	dB	
			0°C	75	98		75	98		
			70°C	75	97		75	97		
I <sub>CC</sub>	Supply current (two amplifiers)	V <sub>O</sub> = 0, No load	25°C		4.6	5.6		4.8	5.6	mA
			0°C		4.7	6.4		4.8	6.4	
			70°C		4.4	6.4		4.6	6.4	
V <sub>O1</sub> /V <sub>O2</sub>	Crosstalk attenuation	A <sub>VD</sub> = 100	25°C		120			120	dB	

## TL052C and TL052AC operating characteristics at specified free-air temperature

PARAMETER	TEST CONDITIONS	T <sub>A</sub> †	TL052C, TL052AC						UNIT	
			V <sub>CC±</sub> = ±5 V			V <sub>CC±</sub> = ±15 V				
			MIN	TYP	MAX	MIN	TYP	MAX		
SR+	Slew rate at unity gain	R <sub>L</sub> = 2 kΩ, C <sub>L</sub> = 100 pF, See Figure 1	25°C	17.8			9	20.7		V/μs
SR-	Negative slew rate at unity gain‡		Full range				8			
			25°C	15.4			9	17.8		
			Full range				8			
t <sub>r</sub>	Rise time	V <sub>I(PP)</sub> = ±10 mV, R <sub>L</sub> = 2 kΩ, C <sub>L</sub> = 100 pF, See Figures 1 and 2	25°C	55			56		ns	
			0°C	54			55			
			70°C	63			63			
t <sub>f</sub>	Fall time		25°C	55			57			
			0°C	54			56			
			70°C	62			64			
	Overshoot factor		25°C	24			19		%	
			0°C	24			19			
			70°C	24			19			
V <sub>n</sub>	Equivalent input noise voltage§	R <sub>S</sub> = 20 Ω, See Figure 3	f = 10 Hz	25°C			71		nV/√Hz	
			f = 1 kHz	25°C			19 30			
V <sub>N(PP)</sub>	Peak-to-peak equivalent input noise current		f = 10 Hz to 10 kHz	25°C			4		μV	
I <sub>n</sub>	Equivalent input noise current	f = 1 kHz	25°C	0.01			0.01		pA/√Hz	
THD	Total harmonic distortion¶	R <sub>S</sub> = 1 kΩ, R <sub>L</sub> = 2 kΩ, f = 1 kHz	25°C	0.003			0.003		%	
B <sub>1</sub>	Unity-gain bandwidth	V <sub>I</sub> = 10 mV, R <sub>L</sub> = 2 kΩ, C <sub>L</sub> = 25 pF, See Figure 4	25°C	3			3		MHz	
			0°C	3.2			3.2			
			70°C	2.6			2.7			
φ <sub>m</sub>	Phase margin at unity gain	V <sub>I</sub> = 10 mV, R <sub>L</sub> = 2 kΩ, C <sub>L</sub> = 25 pF, See Figure 4	25°C	60			63		deg	
			0°C	59			63			
			70°C	60			63			

† Full range is 0°C to 70°C.

‡ For V<sub>CC±</sub> = ±5 V, V<sub>I(PP)</sub> = ±1 V; for V<sub>CC±</sub> = ±15 V, V<sub>I(PP)</sub> = ±5 V.

§ This parameter is tested on a sample basis. For other test requirements, please contact the factory. This statement has no bearing on testing or nontesting of other parameters.

¶ For V<sub>CC±</sub> = ±5 V, V<sub>O(RMS)</sub> = 1 V; for V<sub>CC±</sub> = ±15 V, V<sub>O(RMS)</sub> = 6 V.



# TL05x, TL05xA ENHANCED-JFET LOW-OFFSET OPERATIONAL AMPLIFIERS

SLOS178A – FEBRUARY 1997 - REVISED FEBRUARY 2003

## TL052I and TL052AI electrical characteristics at specified free-air temperature

PARAMETER	TEST CONDITIONS		T <sub>A</sub> †	TL052I, TL052AI						UNIT			
				V <sub>CC±</sub> = ±5 V			V <sub>CC±</sub> = ±15 V						
				MIN	TYP	MAX	MIN	TYP	MAX				
V <sub>IO</sub> Input offset voltage		TL052I	25°C	0.73		3.5		0.65		1.5		mV	
			Full range			5.3				3.3			
			TL052AI	25°C	0.51		2.8		0.4		0.8		
				Full range			4.6				2.6		
α <sub>V<sub>IO</sub></sub> Temperature coefficient‡		TL052I	25°C to 85°C	7		6						μV/°C	
			TL052AI	25°C to 85°C	6		6		25				
Input offset-voltage long-term drift§	V <sub>O</sub> = 0, R <sub>S</sub> = 50 Ω	V <sub>IC</sub> = 0,	25°C	0.04		0.04						μV/mo	
I <sub>IO</sub> Input offset current	V <sub>O</sub> = 0, See Figure 5	V <sub>IC</sub> = 0,	25°C	4		100		5		100		pA	
			85°C	0.06		10		0.07		10		nA	
I <sub>IB</sub> Input bias current	V <sub>O</sub> = 0, See Figure 5	V <sub>IC</sub> = 0,	25°C	20		200		30		200		pA	
			85°C	0.6		20		0.7		20		nA	
V <sub>ICR</sub> Common-mode input voltage range			25°C	-1 to 4	-2.3 to 5.6			-11 to 11	-12.3 to 15.6			V	
			Full range	-1 to 4				-11 to 11					
V <sub>OM+</sub> Maximum positive peak output voltage swing	R <sub>L</sub> = 10 kΩ		25°C	3		4.2		13		13.9		V	
			Full range	3				13					
	R <sub>L</sub> = 2 kΩ	25°C	2.5		3.8		11.5		12.7				
		Full range	2.5				11.5						
V <sub>OM-</sub> Maximum negative peak output voltage swing	R <sub>L</sub> = 10 kΩ		25°C	-2.5		-3.5		-12		-13.2		V	
			Full range	-2.5				-12					
	R <sub>L</sub> = 2 kΩ	25°C	-2.3		-3.2		-11		-12				
		Full range	-2.3				-11						
A <sub>VD</sub> Large-signal differential voltage amplification¶	R <sub>L</sub> = 2 kΩ		25°C	25		59		50		105		V/mV	
			-40°C	30		74		60		145			
			85°C	20		43		30		76			
r <sub>i</sub> Input resistance			25°C	10 <sup>12</sup>		10 <sup>12</sup>						Ω	
c <sub>i</sub> Input capacitance			25°C	10		12						pF	
CMRR Common-mode rejection ratio	V <sub>IC</sub> = V <sub>ICRmin</sub> , V <sub>O</sub> = 0, R <sub>S</sub> = 50 Ω		25°C	65		85		75		93		dB	
			-40°C	65		83		75		90			
			85°C	65		84		75		93			

† Full range is -40°C to 85°C.

‡ This parameter is tested on a sample basis. For other test requirements, please contact the factory. This statement has no bearing on testing or nontesting of other parameters

§ Typical values are based on the input offset-voltage shift observed through 168 hours of operating life test at T<sub>A</sub> = 150°C, extrapolated to T<sub>A</sub> = 25°C using the Arrhenius equation, and assuming an activation energy of 0.96 eV.

¶ At V<sub>CC±</sub> = ±5 V, V<sub>O</sub> = ±2.3 V; at V<sub>CC±</sub> = ±15 V, V<sub>O</sub> = ±10 V.



# TL05x, TL05xA ENHANCED-JFET LOW-OFFSET OPERATIONAL AMPLIFIERS

SLOS178A – FEBRUARY 1997 - REVISED FEBRUARY 2003

## TL052I and TL052AI electrical characteristics at specified free-air temperature (continued)

PARAMETER	TEST CONDITIONS	T <sub>A</sub>	TL052I, TL052AI						UNIT	
			V <sub>CC±</sub> = ±5 V			V <sub>CC±</sub> = ±15 V				
			MIN	TYP	MAX	MIN	TYP	MAX		
k <sub>SVR</sub>	Supply-voltage rejection ratio (ΔV <sub>CC±</sub> /ΔV <sub>IO</sub> )	V <sub>O</sub> = 0, R <sub>S</sub> = 50 Ω	25°C	75	99		75	99	dB	
			-40°C	75	98		75	98		
			85°C	75	99		75	99		
I <sub>CC</sub>	Supply current (two amplifiers)	V <sub>O</sub> = 0, No load	25°C		4.6	5.6		4.8	5.6	mA
			-40°C		4.5	6.4		4.7	6.4	
			85°C		4.4	6.4		4.6	6.4	
V <sub>O1</sub> /V <sub>O2</sub>	Crosstalk attenuation	A <sub>VD</sub> = 100	25°C		120			120	dB	

## TL052I and TL052AI operating characteristics at specified free-air temperature

PARAMETER	TEST CONDITIONS	T <sub>A</sub> †	TL052I, TL052AI						UNIT	
			V <sub>CC±</sub> = ±5 V			V <sub>CC±</sub> = ±15 V				
			MIN	TYP	MAX	MIN	TYP	MAX		
SR+	Slew rate at unity gain‡	R <sub>L</sub> = 2 kΩ, C <sub>L</sub> = 100 pF, See Figure 1	25°C		17.8		9	20.7	V/μs	
			Full range				8			
SR-	Negative slew rate at unity gain‡		25°C		15.4		9	17.8		
			Full range				8			
t <sub>r</sub>	Rise time	V <sub>I(PP)</sub> = ±10 mV, R <sub>L</sub> = 2 kΩ, C <sub>L</sub> = 100 pF, See Figures 1 and 2	25°C		55			56	ns	
			-40°C		52			53		
			85°C		64			65		
t <sub>f</sub>	Fall time		25°C		55			57		
			-40°C		51			53		
			85°C		64			65		
	Overshoot factor		25°C		24%			19%	%	
			-40°C		24%			19%		
			85°C		24%			19%		
V <sub>n</sub>	Equivalent input noise voltage§	R <sub>S</sub> = 20 Ω, See Figure 3	f = 10 Hz	25°C		71		71	nV/√Hz	
			f = 1 kHz	25°C		19		19		30
V <sub>N(PP)</sub>	Peak-to-peak equivalent input noise current		f = 10 Hz to 10 kHz	25°C		4		4		μV
I <sub>n</sub>	Equivalent input noise current	f = 1 kHz	25°C		0.01		0.01	pA/√Hz		
THD	Total harmonic distortion¶	R <sub>S</sub> = 1 kΩ, f = 1 kHz, R <sub>L</sub> = 2 kΩ	25°C		0.003		0.003	%		
B <sub>1</sub>	Unity-gain bandwidth	V <sub>I</sub> = 10 mV, C <sub>L</sub> = 25 pF, R <sub>L</sub> = 2 kΩ, See Figure 4	25°C		3		3	MHz		
			-40°C		3.5		3.6			
			85°C		2.5		2.6			
φ <sub>m</sub>	Phase margin at unity gain	V <sub>I</sub> = 10 mV, C <sub>L</sub> = 25 pF, R <sub>L</sub> = 2 kΩ, See Figure 4	25°C		60		63	deg		
			-40°C		58		61			
			85°C		60		63			

† Full range is -40°C to 85°C.

‡ For V<sub>CC±</sub> = ±5 V, V<sub>I(PP)</sub> = ±1 V; for V<sub>CC±</sub> = ±15 V, V<sub>I(PP)</sub> = ±5 V.

§ This parameter is tested on a sample basis. For other test requirements, please contact the factory. This statement has no bearing on testing or nontesting of other parameters.

¶ For V<sub>CC±</sub> = ±5 V, V<sub>O(RMS)</sub> = 1 V; for V<sub>CC±</sub> = ±15 V, V<sub>O(RMS)</sub> = 6 V.



**TL05x, TL05xA**  
**ENHANCED-JFET LOW-OFFSET**  
**OPERATIONAL AMPLIFIERS**

SLOS178A – FEBRUARY 1997 - REVISED FEBRUARY 2003

**TL054C and TL054AC electrical characteristics at specified free-air temperature**

PARAMETER	TEST CONDITIONS	T <sub>A</sub> †	TL054C, TL054AC						UNIT			
			V <sub>CC±</sub> = ±5 V			V <sub>CC±</sub> = ±15 V						
			MIN	TYP	MAX	MIN	TYP	MAX				
V <sub>IO</sub>	Input offset voltage	TL054C	25°C	0.64		5.5		0.56		4		
			Full range			7.7				6.2		
			TL054AC	25°C	0.57		3.5		0.5		1.5	
				Full range			5.7				3.7	
α <sub>V<sub>IO</sub></sub>	Temperature coefficient of input offset voltage	TL054C	25°C to 70°C	25				23				
			TL054AC	25°C to 70°C	24				23			
	Input offset-voltage long-term drift‡		25°C	0.04				0.04		μV/mo		
I <sub>IO</sub>	Input offset current	V <sub>O</sub> = 0, V <sub>IC</sub> = 0, See Figure 5	25°C	4		100		5		100		
			70°C	0.02		1		0.025		1		
I <sub>IB</sub>	Input bias current	V <sub>O</sub> = 0, V <sub>IC</sub> = 0, See Figure 5	25°C	20		200		30		200		
			70°C	0.15		4		0.2		4		
V <sub>ICR</sub>	Common-mode input voltage range		25°C	-1 to 4		-2.3 to 5.6		-11 to 11		-12.3 to 15.6		
			Full range	-1 to 4				-11 to 11				
V <sub>OM+</sub>	Maximum positive peak output voltage swing	R <sub>L</sub> = 10 kΩ	25°C	3		4.2		13		13.9		
			Full range	3				13				
		R <sub>L</sub> = 2 kΩ	25°C	2.5		3.8		11.5		12.7		
			Full range	2.5				11.5				
V <sub>OM-</sub>	Maximum negative peak output voltage swing	R <sub>L</sub> = 10 kΩ	25°C	-2.5		-3.5		-12		-13.2		
			Full range	-2.5				-12				
		R <sub>L</sub> = 2 kΩ	25°C	-2.3		-3.2		-11		-12		
			Full range	-2.3				-11				
A <sub>VD</sub>	Large-signal differential voltage amplification§	R <sub>L</sub> = 2 kΩ	25°C	25		72		50		133		
			0°C	30		88		60		173		
			70°C	20		57		30		85		
r <sub>i</sub>	Input resistance		25°C	10 <sup>12</sup>				10 <sup>12</sup>		Ω		
c <sub>i</sub>	Input capacitance		25°C	10				12		pF		
CMRR	Common-mode rejection ratio	V <sub>IC</sub> = V <sub>ICRmin</sub> , V <sub>O</sub> = 0, R <sub>S</sub> = 50 Ω	25°C	65		84		75		92		
			0°C	65		84		75		92		
			70°C	65		84		75		93		
k <sub>SVR</sub>	Supply-voltage rejection ratio (ΔV <sub>CC±</sub> /ΔV <sub>IO</sub> )	V <sub>CC±</sub> = ±5 V to ±15 V, V <sub>O</sub> = 0, R <sub>S</sub> = 50 Ω	25°C	75		99		75		99		
			0°C	75		99		75		99		
			70°C	75		99		75		99		
I <sub>CC</sub>	Supply current (four amplifiers)	V <sub>O</sub> = 0, No load	25°C	8.1		11.2		8.4		11.2		
			0°C	8.2		12.8		8.5		12.8		
			70°C	7.9		11.2		8.2		11.2		
V <sub>O1</sub> /V <sub>O2</sub>	Crosstalk attenuation	A <sub>VD</sub> = 100	25°C	120				120		dB		

† Full range is 0°C to 70°C.

‡ Typical values are based on the input offset-voltage shift observed through 168 hours of operating life test at T<sub>A</sub> = 150°C, extrapolated to T<sub>A</sub> = 25°C using the Arrhenius equation, and assuming an activation energy of 0.96 eV.

§ For V<sub>CC±</sub> = ±5 V, V<sub>O</sub> = ±2.3 V, at V<sub>CC±</sub> = ±15 V, V<sub>O</sub> = ±10 V.B



# TL05x, TL05xA ENHANCED-JFET LOW-OFFSET OPERATIONAL AMPLIFIERS

SLOS178A – FEBRUARY 1997 - REVISED FEBRUARY 2003

## TL054C and TL054AC operating characteristics at specified free-air temperature

PARAMETER	TEST CONDITIONS	T <sub>A</sub> †	TL054C, TL054C						UNIT		
			V <sub>CC±</sub> = ±5 V			V <sub>CC±</sub> = ±15 V					
			MIN	TYP	MAX	MIN	TYP	MAX			
SR+	Positive slew rate at unity gain		25°C	15.4			10 17.8			V/μs	
			0°C	15.7			8 17.9				
			70°C	14.4			8 17.5				
SR-	Negative slew rate at unity gain‡	R <sub>L</sub> = 2 kΩ, C <sub>L</sub> = 100 pF, See Figure 1 and Note 7	25°C	13.9			10 15.9				
			0°C	14.3			8 16.1				
			70°C	13.3			8 15.5				
t <sub>r</sub>	Rise time		25°C	55			56			ns	
			0°C	54			55				
			70°C	63			63				
t <sub>f</sub>	Fall time	V <sub>I(PP)</sub> = ±10 mV, R <sub>L</sub> = 2 kΩ, C <sub>L</sub> = 100 pF, See Figures 1 and 2	25°C	55			57				
			0°C	54			56				
			70°C	62			64				
	Overshoot factor		25°C	24%			19%			%	
			0°C	24%			19%				
			70°C	24%			19				
V <sub>n</sub>	Equivalent input noise voltage§	R <sub>S</sub> = 20 Ω, See Figure 3	f = 10 Hz	25°C	75			75			nV/√Hz
			f = 1 kHz	25°C	21			21 45			
V <sub>N(PP)</sub>	Peak-to-peak equivalent input noise voltage		f = 10 Hz to 10 kHz	25°C	4			4			μV
I <sub>n</sub>	Equivalent input noise current	f = 1 kHz	25°C	0.01			0.01			pA/√Hz	
THD	Total harmonic distortion¶	R <sub>S</sub> = 1 kΩ, R <sub>L</sub> = 2 kΩ, f = 1 kHz	25°C	0.003			0.003			%	
B <sub>1</sub>	Unity-gain bandwidth	V <sub>I</sub> = 10 mV, R <sub>L</sub> = 2 kΩ, C <sub>L</sub> = 25 pF, See Figure 4	25°C	2.7			2.7			MHz	
			0°C	3			3				
			70°C	2.4			2.4				
φ <sub>m</sub>	Phase margin at unity gain	V <sub>I</sub> = 10 mV, R <sub>L</sub> = 2 kΩ, C <sub>L</sub> = 25 pF, See Figure 4	25°C	61			64			deg	
			0°C	60			64				
			70°C	61			63				

† Full range is 0°C to 70°C.

‡ For V<sub>CC±</sub> = ±5 V, V<sub>I(PP)</sub> = ±1 V; for V<sub>CC±</sub> = ±15 V, V<sub>I(PP)</sub> = ±5 V.

§ This parameter is tested on a sample basis. For other test requirements, please contact the factory. This statement has no bearing on testing or nontesting of other parameters.

¶ For V<sub>CC±</sub> = ±5 V, V<sub>O(RMS)</sub> = 1 V; for V<sub>CC±</sub> = ±15 V, V<sub>O(RMS)</sub> = 6 V.



**TL05x, TL05xA**  
**ENHANCED-JFET LOW-OFFSET**  
**OPERATIONAL AMPLIFIERS**

SLOS178A – FEBRUARY 1997 - REVISED FEBRUARY 2003

**TL054I and TL054AI electrical characteristics at specified free-air temperature**

PARAMETER	TEST CONDITIONS	T <sub>A</sub> †	TL054I, TL054AI						UNIT
			V <sub>CC±</sub> = ±5 V			V <sub>CC±</sub> = ±15 V			
			MIN	TYP	MAX	MIN	TYP	MAX	
V <sub>IO</sub>	Input offset voltage	TL054I	25°C	0.64 5.5		0.56 4		mV	
			Full range	8.8		7.3			
			TL054AI	25°C	0.57 3.5		0.5 1.5		
				Full range	6.8		4.8		
α <sub>V<sub>IO</sub></sub>	Temperature coefficient of input offset voltage	TL054I	25°C to 85°C	25		24		μV/°C	
		TL054AI	25°C to 85°C	25		23			
	Input offset voltage long-term drift‡		25°C	0.04		0.04		μV/mo	
I <sub>IO</sub>	Input offset current	V <sub>O</sub> = 0, V <sub>IC</sub> = 0, See Figure 5	25°C	4	100	5	100	pA	
			85°C	0.06	10	0.07	10	nA	
I <sub>IB</sub>	Input bias current	V <sub>O</sub> = 0, V <sub>IC</sub> = 0, See Figure 5	25°C	20	200	30	200	pA	
			85°C	0.6	20	0.7	20	nA	
V <sub>ICR</sub>	Common-mode input voltage range		25°C	-1 to 4	-2.3 to 5.6	-11 to 11	-12.3 to 15.6	V	
			Full range	-1 to 4		-11 to 11			
V <sub>OM+</sub>	Maximum positive peak output voltage swing	R <sub>L</sub> = 10 kΩ	25°C	3	4.2	13	13.9	V	
			Full range	3		13			
		R <sub>L</sub> = 2 kΩ	25°C	2.5	3.8	11.5	12.7		
			Full range	2.5		11.5			
V <sub>OM-</sub>	Maximum negative peak output voltage swing	R <sub>L</sub> = 10 kΩ	25°C	-2.5	-3.5	-12	-13.2	V	
			Full range	-2.5		-12			
		R <sub>L</sub> = 2 kΩ	25°C	-2.3	-3.2	-11	-12		
			Full range	-2.3		-11			
A <sub>VD</sub>	Large-signal differential voltage amplification§	R <sub>L</sub> = 2 kΩ	25°C	25	72	50	133	V/mV	
			-40°C	30	101	60	212		
			85°C	20	50	30	70		
r <sub>i</sub>	Input resistance		25°C	10 <sup>12</sup>		10 <sup>12</sup>		Ω	
c <sub>i</sub>	Input capacitance		25°C	10		12		pF	
CMRR	Common-mode rejection ratio	V <sub>IC</sub> = V <sub>ICRmin</sub> , V <sub>O</sub> = 0, R <sub>S</sub> = 50 Ω	25°C	65	84	75	92	dB	
			-40°C	65	83	75	92		
			85°C	65	84	75	93		
k <sub>SVR</sub>	Supply-voltage rejection ratio (ΔV <sub>CC±</sub> /ΔV <sub>IO</sub> )	V <sub>CC±</sub> = ±5 V to ±15 V, V <sub>O</sub> = 0, R <sub>S</sub> = 50 Ω	25°C	75	99	75	99	dB	
			-40°C	75	98	75	99		
			85°C	75	99	75	99		
I <sub>CC</sub>	Supply current (four amplifiers)	V <sub>O</sub> = 0, No load	25°C	8.1	11.2	8.4	11.2	mA	
			-40°C	7.9	12.8	8.2	12.8		
			85°C	7.6	11.2	7.9	11.2		
V <sub>O1</sub> /V <sub>O2</sub>	Crosstalk attenuation	A <sub>VD</sub> = 100	25°C	120		120		dB	

† Full range is -40°C to 85°C.

‡ Typical values are based on the input offset voltage shift observed through 168 hours of operating life test at T<sub>A</sub> = 150°C, extrapolated to T<sub>A</sub> = 25°C using the Arrhenius equation, and assuming an activation energy of 0.96 eV.

§ For V<sub>CC±</sub> = ±5 V, V<sub>O</sub> = ±2.3 V, at V<sub>CC±</sub> = ±15 V, V<sub>O</sub> = ±10 V.



# TL05x, TL05xA ENHANCED-JFET LOW-OFFSET OPERATIONAL AMPLIFIERS

SLOS178A – FEBRUARY 1997 - REVISED FEBRUARY 2003

## TL054I and TL054AI operating characteristics at specified free-air temperature

PARAMETER	TEST CONDITIONS	T <sub>A</sub> †	TL054I, TL054AI			UNIT	
			V <sub>CC±</sub> = ±5 V		V <sub>CC±</sub> = ±15 V		
			MIN	TYP	MAX		MIN
SR+	Positive slew rate at unity gain	25°C	15.4		10 17.8		V/μs
			-40°C		8 18		
SR-	Negative slew rate at unity gain‡	R <sub>L</sub> = 2 kΩ, C <sub>L</sub> = 100 pF, See Figure 1	85°C		8 17.3		
			25°C		10 15.9		
			-40°C		8 16.1		
			85°C		8 15.3		
t <sub>r</sub>	Rise time	25°C	55		56		ns
			-40°C		53		
			85°C		65		
t <sub>f</sub>	Fall time	V <sub>I(PP)</sub> = ±10 mV, R <sub>L</sub> = 2 kΩ, C <sub>L</sub> = 100 pF, See Figures 1 and 2	25°C		57		
			-40°C		53		
			85°C		65		
Overshoot factor		25°C	24		19		%
			-40°C		19		
			85°C		19		
V <sub>n</sub>	Equivalent input noise voltage§	R <sub>S</sub> = 20 Ω, See Figure 3	f = 10 Hz	25°C	75		nV/√Hz
			f = 1 kHz	25°C	21 45		
V <sub>N(PP)</sub>	Peak-to-peak equivalent input noise voltage		f = 10 Hz to 10 kHz	25°C	4		μV
I <sub>n</sub>	Equivalent input noise current	f = 1 kHz		25°C	0.01		pA/√Hz
THD	Total harmonic distortion¶	R <sub>S</sub> = 1 kΩ, f = 1 kHz	R <sub>L</sub> = 2 kΩ,	25°C	0.003%		%
B <sub>1</sub>	Unity-gain bandwidth	V <sub>I</sub> = 10 mV, C <sub>L</sub> = 25 pF,	R <sub>L</sub> = 2 kΩ, See Figure 4	25°C	2.7		MHz
				-40°C	3.3		
				85°C	2.4		
φ <sub>m</sub>	Phase margin at unity gain	V <sub>I</sub> = 10 mV, C <sub>L</sub> = 25 pF,	R <sub>L</sub> = 2 kΩ, See Figure 4	25°C	64		deg
				-40°C	62		
				85°C	64		

† Full range is -40°C to 85°C.

‡ For V<sub>CC±</sub> = ±5 V, V<sub>I(PP)</sub> = ±1 V; for V<sub>CC±</sub> = ±15 V, V<sub>I(PP)</sub> = ±5 V.

§ This parameter is tested on a sample basis. For other test requirements, please contact the factory. This statement has no bearing on testing or nontesting of other parameters.

¶ For V<sub>CC±</sub> = ±5 V, V<sub>O(RMS)</sub> = 1 V; for V<sub>CC±</sub> = ±15 V, V<sub>O(RMS)</sub> = 6 V.



**PARAMETER MEASUREMENT INFORMATION**

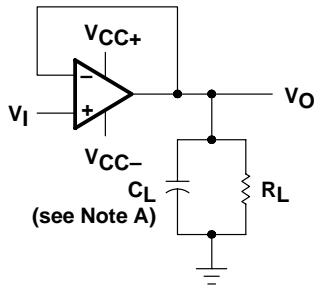

NOTE A:  $C_L$  includes fixture capacitance.

**Figure 1. Slew Rate, Rise/Fall Time, and Overshoot Test Circuit**

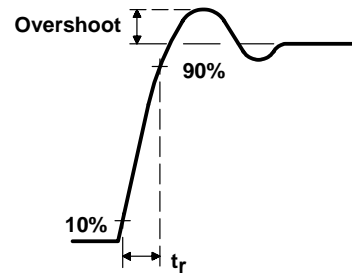

**Figure 2. Rise-Time and Overshoot Waveform**

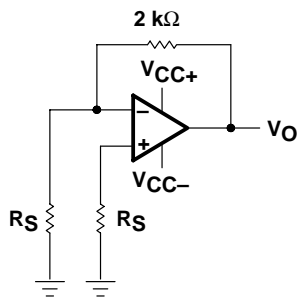

**Figure 3. Noise-Voltage Test Circuit**

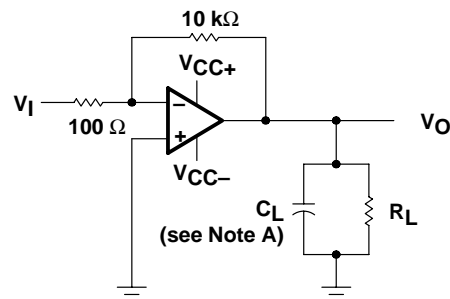

NOTE A:  $C_L$  includes fixture capacitance.

**Figure 4. Unity-Gain Bandwidth and Phase-Margin Test Circuit**

**typical values**

Typical values, as presented in this data sheet represent the median (50% point) of device parametric performance.

**input bias and offset current**

At the picoamp-bias-current level typical of the TL05x and TL05xA, accurate measurement of the bias current becomes difficult. Not only does this measurement require a picoammeter, but test-socket leakages easily can exceed the actual device bias currents. To accurately measure these small currents, Texas Instruments uses a two-step process. The socket leakage is measured using picoammeters with bias voltages applied, but with no device in the socket. The device then is inserted in the socket, and a second test that measures both the socket leakage and the device input bias current is performed. The two measurements then are subtracted algebraically to determine the bias current of the device.

**noise**

Because of the increasing emphasis on low noise levels in many of today's applications, the input noise voltage density is sample tested at  $f = 1$  kHz. Texas Instruments also has additional noise-testing capability to meet specific application requirements. Please contact the factory for details.

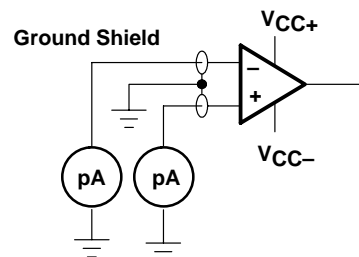

**Figure 5. Input-Bias and Offset-Current Test Circuit**

**TL05x, TL05xA**  
**ENHANCED-JFET LOW-OFFSET**  
**OPERATIONAL AMPLIFIERS**

SLOS178A – FEBRUARY 1997 - REVISED FEBRUARY 2003

**TYPICAL CHARACTERISTICS**

**Table of Graphs**

			<b>FIGURE</b>
$V_{IO}$	Input offset voltage	Distribution	6–11
$\alpha_{V_{IO}}$	Temperature coefficient of input offset voltage	Distribution	12, 13, 14
$I_{IB}$	Input bias current	vs Common-mode input voltage	15
		vs Free-air temperature	16
$I_{IO}$	Input offset current	vs Free-air temperature	16
$V_{IC}$	Common-mode input voltage range limits	vs Supply voltage	17
		vs Free-air temperature	18
$V_O$	Output voltage	vs Differential input voltage	19, 20
$V_{OM}$	Maximum peak output voltage	vs Supply voltage	21
		vs Output current	25, 26
		vs Free-air temperature	27, 28
$V_{O(PP)}$	Maximum peak-to-peak output voltage	vs Frequency	22, 23, 24
$A_{VD}$	Large-signal differential voltage amplification	vs Load resistance	29
		vs Frequency	30
		vs Free-air temperature	31, 32, 33
CMRR	Common-mode rejection ratio	vs Frequency	34, 35
		vs Free-air temperature	36
$z_o$	Output impedance	vs Frequency	37
$k_{SVR}$	Supply-voltage rejection ratio	vs Free-air temperature	38
$I_{OS}$	Short-circuit output current	vs Supply voltage	39
		vs Time	40
		vs Free-air temperature	41
$I_{CC}$	Supply current	vs Supply voltage	42, 43, 44
		vs Free-air temperature	45, 46, 47
SR	Slew rate	vs Load resistance	48–53
		vs Free-air temperature	54–59
	Overshoot factor	vs Load capacitance	60
$V_n$	Equivalent input noise voltage	vs Frequency	61, 62
THD	Total harmonic distortion	vs Frequency	63
$B_1$	Unity-gain bandwidth	vs Supply voltage	64, 65, 66
		vs Free-air temperature	67, 68, 69
$\phi_m$	Phase margin	vs Supply voltage	70, 71, 72
		vs Load capacitance	73, 74, 75
		vs Free-air temperature	76, 77, 78
	Phase shift	vs Frequency	30
	Voltage-follower small-signal pulse response	vs Time	79
	Voltage-follower large-signal pulse response	vs Time	80



**TYPICAL CHARACTERISTICS**

**DISTRIBUTION OF TL051  
 INPUT OFFSET VOLTAGE**

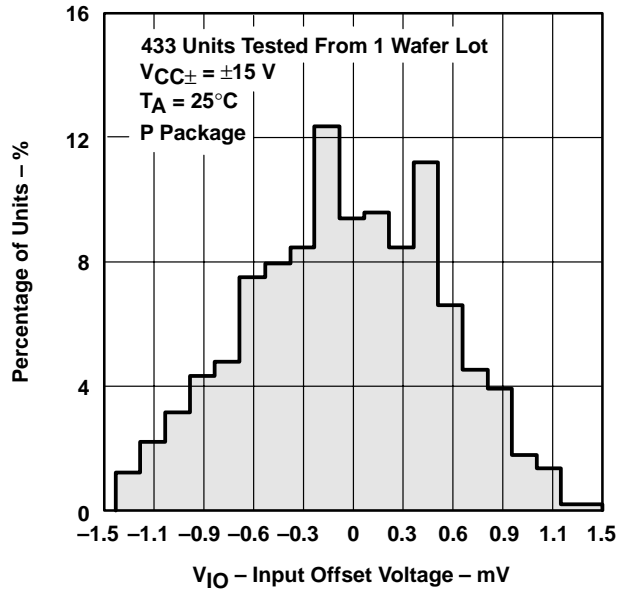

**Figure 6**

**DISTRIBUTION OF TL051A  
 INPUT OFFSET VOLTAGE**

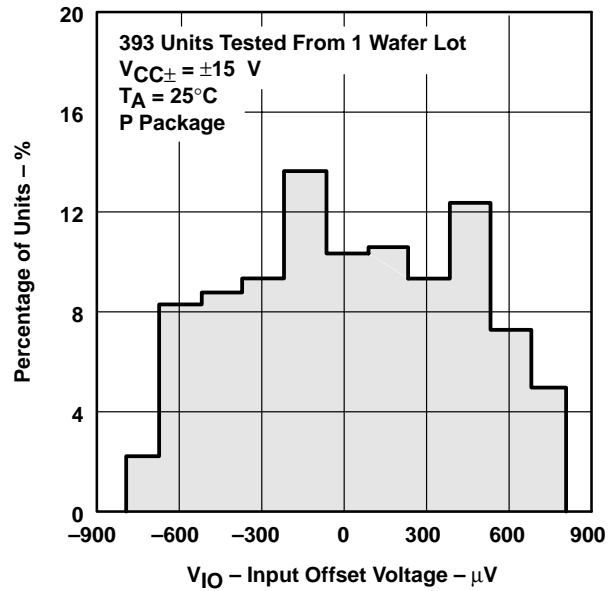

**Figure 7**

**DISTRIBUTION OF TL052  
 INPUT OFFSET VOLTAGE**

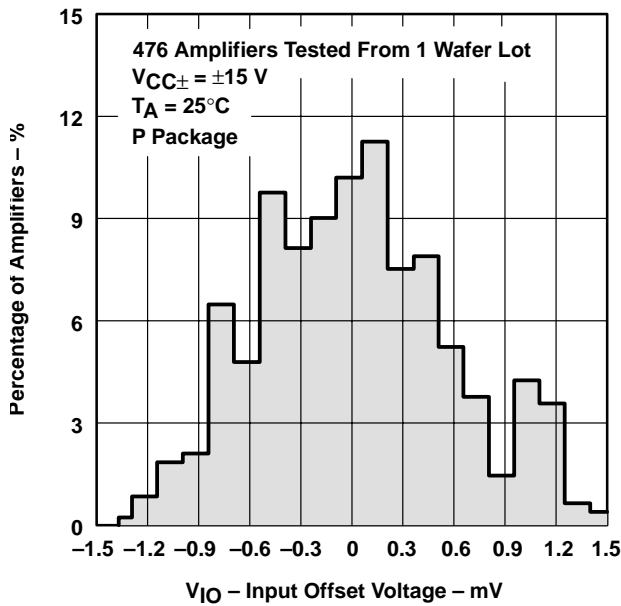

**Figure 8**

**DISTRIBUTION OF TL052A  
 INPUT OFFSET VOLTAGE**

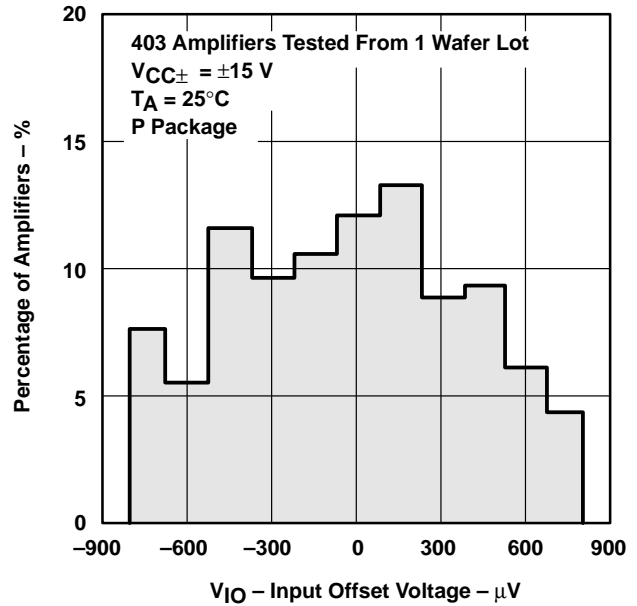

**Figure 9**

**TL05x, TL05xA**  
**ENHANCED-JFET LOW-OFFSET**  
**OPERATIONAL AMPLIFIERS**

SLOS178A – FEBRUARY 1997 - REVISED FEBRUARY 2003

**TYPICAL CHARACTERISTICS**

**DISTRIBUTION OF TL054**  
**INPUT OFFSET VOLTAGE**

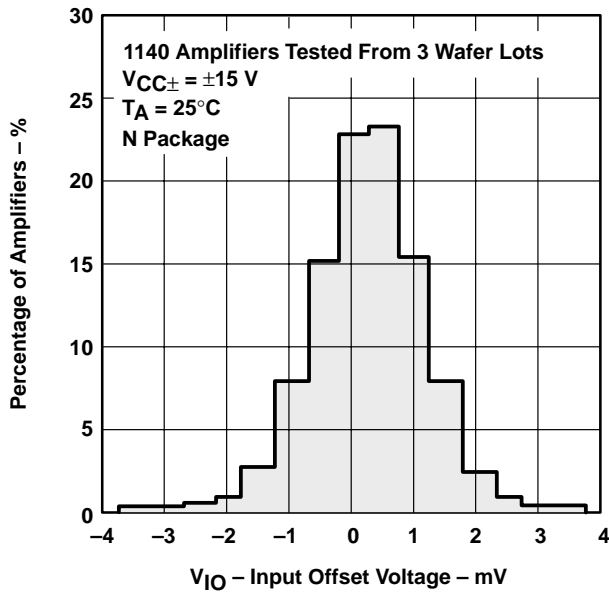

**Figure 10**

**DISTRIBUTION OF TL054A**  
**INPUT OFFSET VOLTAGE**

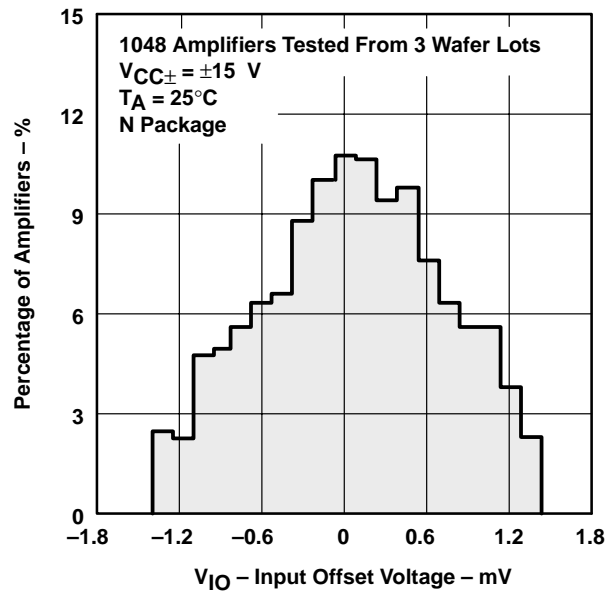

**Figure 11**

**DISTRIBUTION OF TL051**  
**INPUT OFFSET VOLTAGE**  
**TEMPERATURE COEFFICIENT**

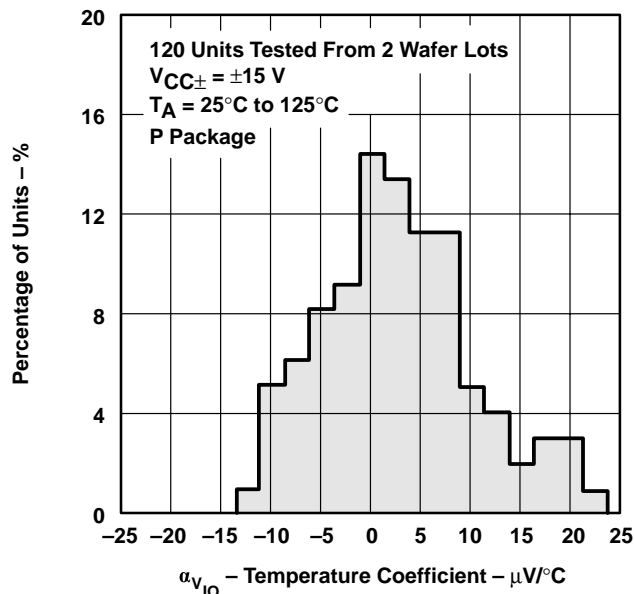

**Figure 12**

**DISTRIBUTION OF TL052**  
**INPUT OFFSET VOLTAGE**  
**TEMPERATURE COEFFICIENT**

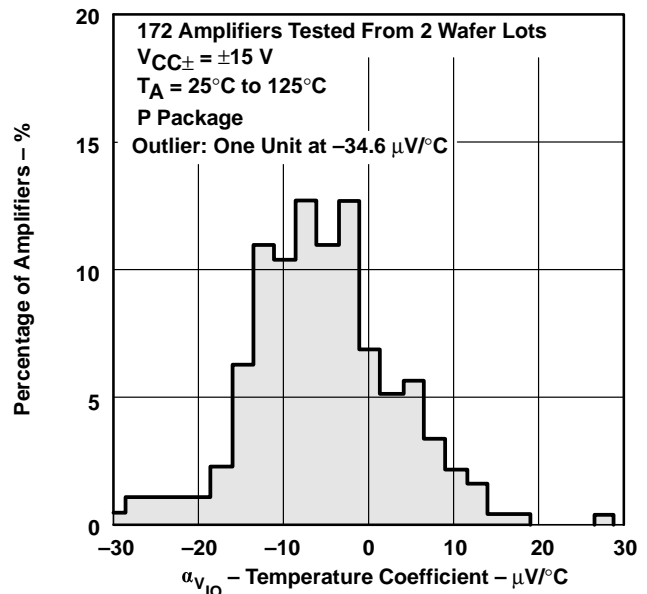

**Figure 13**

**TYPICAL CHARACTERISTICS**

**DISTRIBUTION OF TL054  
 INPUT OFFSET VOLTAGE  
 TEMPERATURE COEFFICIENT**

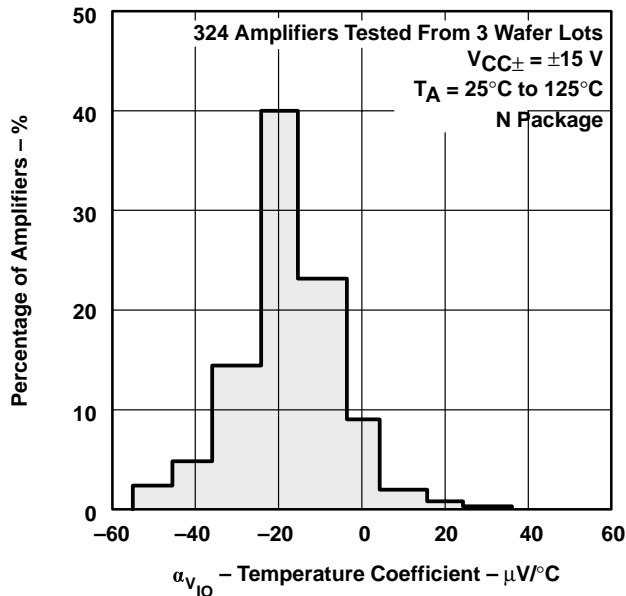

**Figure 14**

**INPUT BIAS CURRENT  
 vs  
 COMMON-MODE INPUT VOLTAGE**

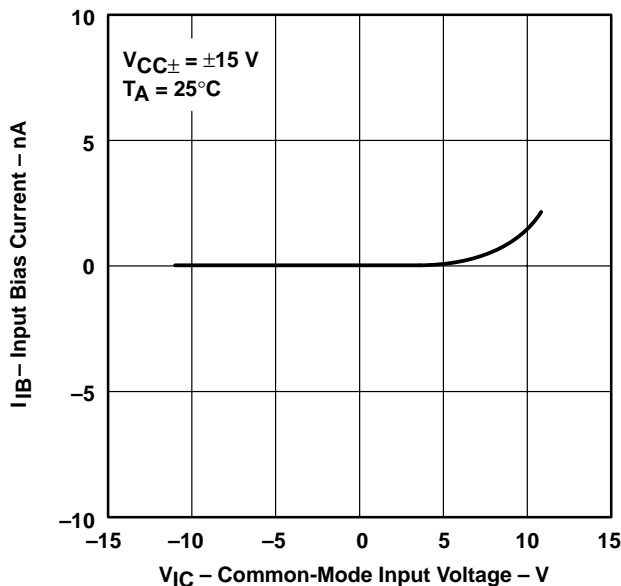

**Figure 15**

**INPUT BIAS CURRENT AND  
 INPUT OFFSET CURRENT†  
 vs  
 FREE-AIR TEMPERATURE**

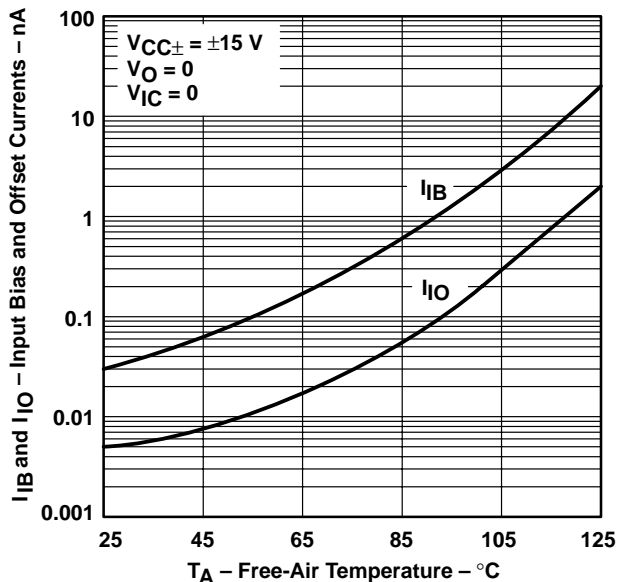

**Figure 16**

**COMMON-MODE  
 INPUT VOLTAGE RANGE LIMITS  
 vs  
 SUPPLY VOLTAGE**

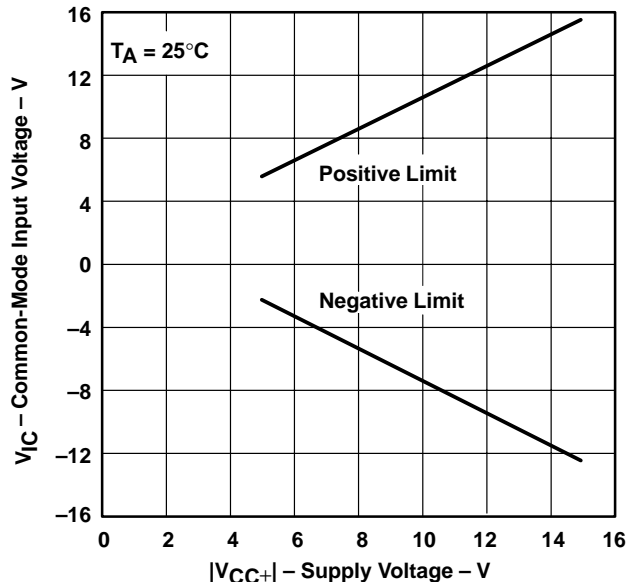

**Figure 17**

† Data at high and low temperatures are applicable only within the rated operating free-air temperature ranges of the various devices.

**TL05x, TL05xA**  
**ENHANCED-JFET LOW-OFFSET**  
**OPERATIONAL AMPLIFIERS**

SLOS178A – FEBRUARY 1997 - REVISED FEBRUARY 2003

**TYPICAL CHARACTERISTICS**

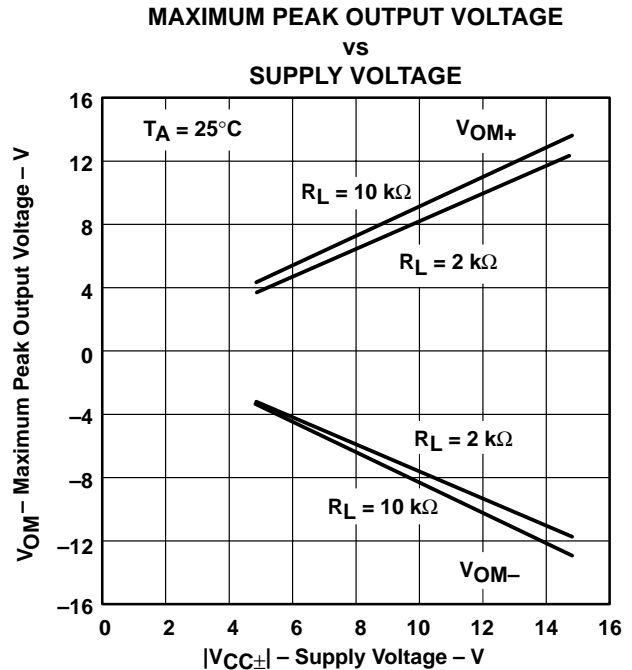
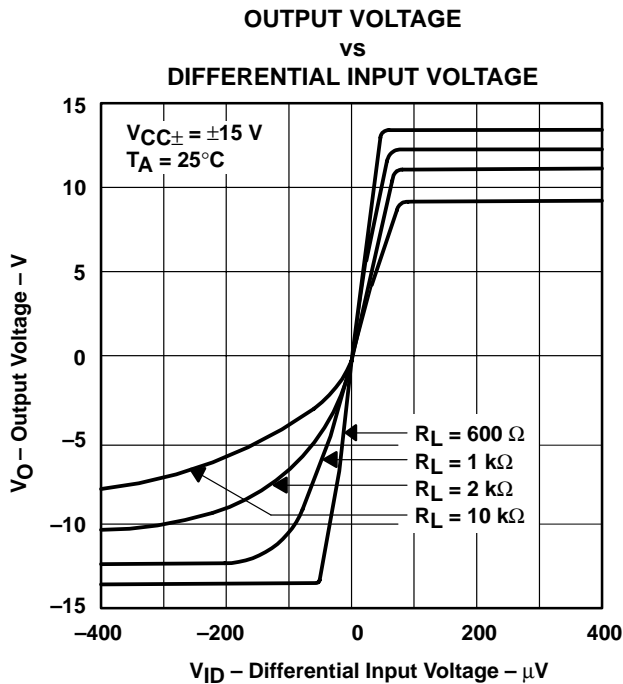
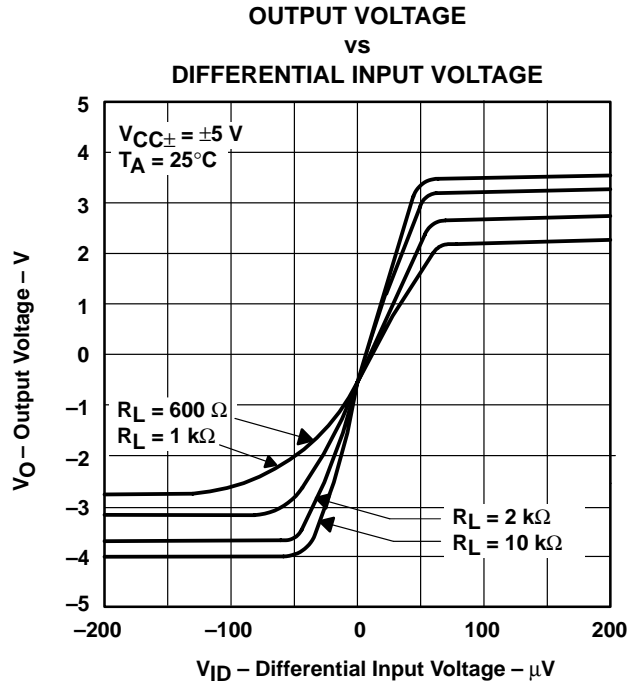
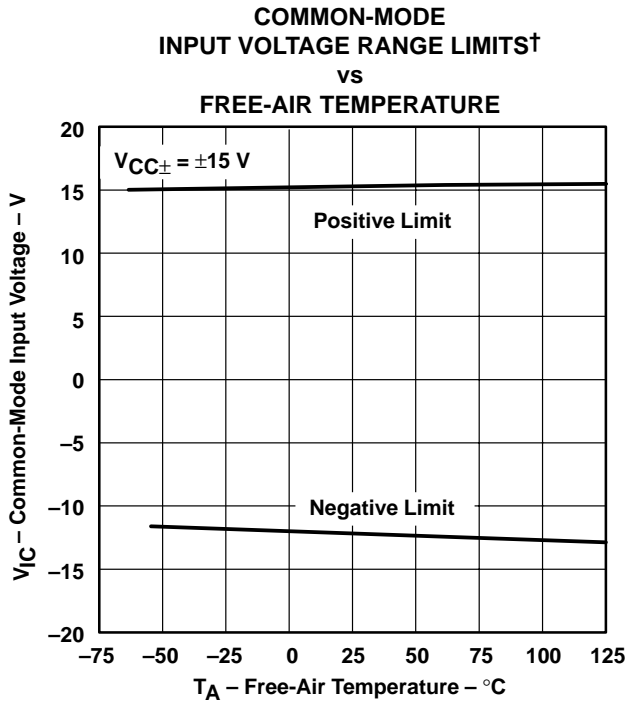

† Data at high and low temperatures are applicable only within the rated operating free-air temperature ranges of the various devices.



**TYPICAL CHARACTERISTICS**

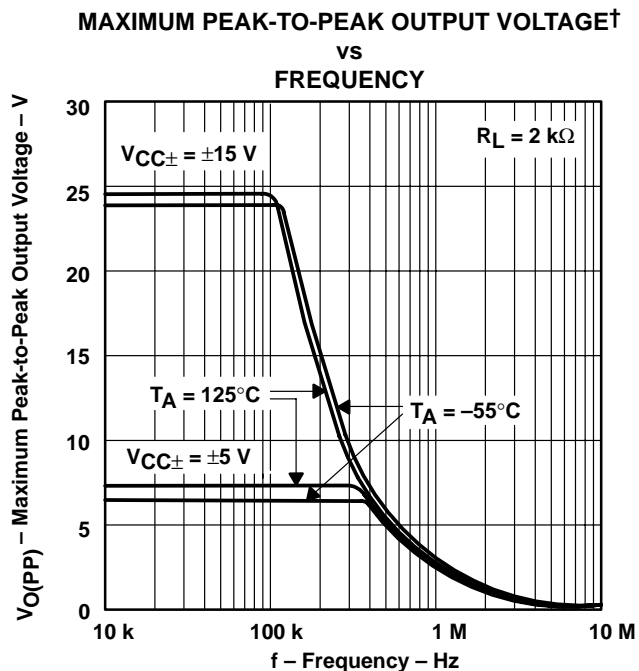

Figure 22

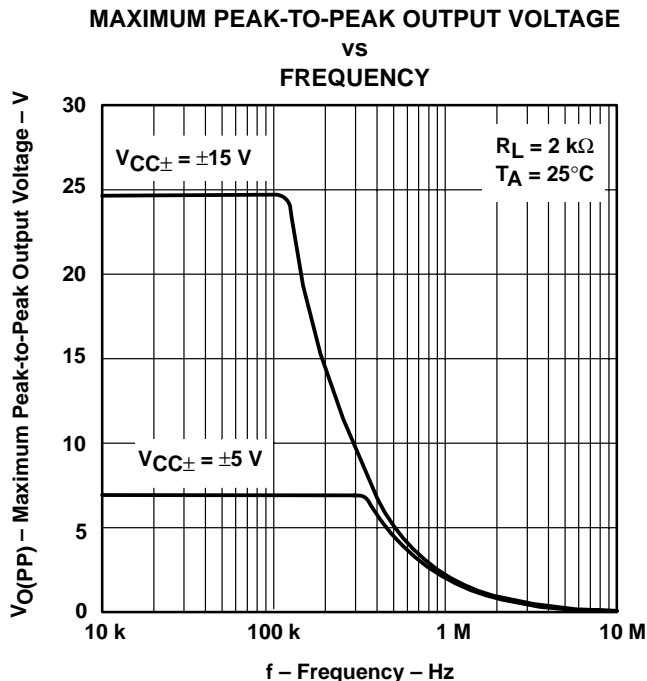

Figure 23

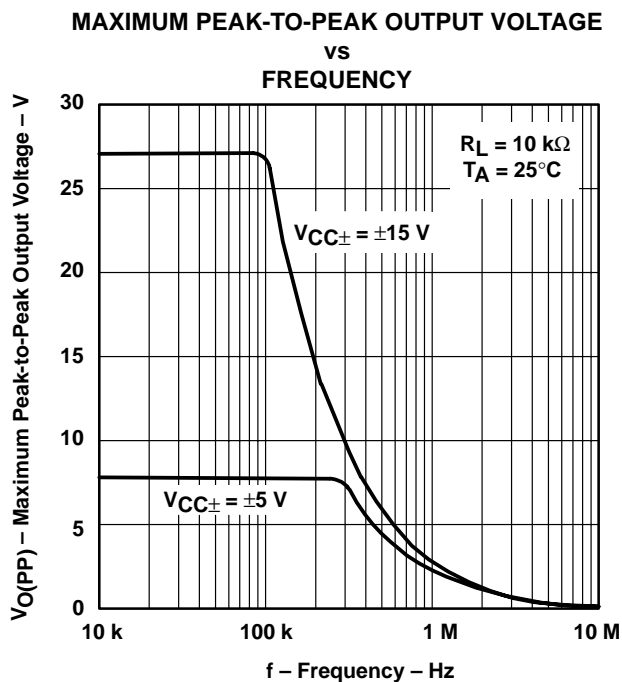

Figure 24

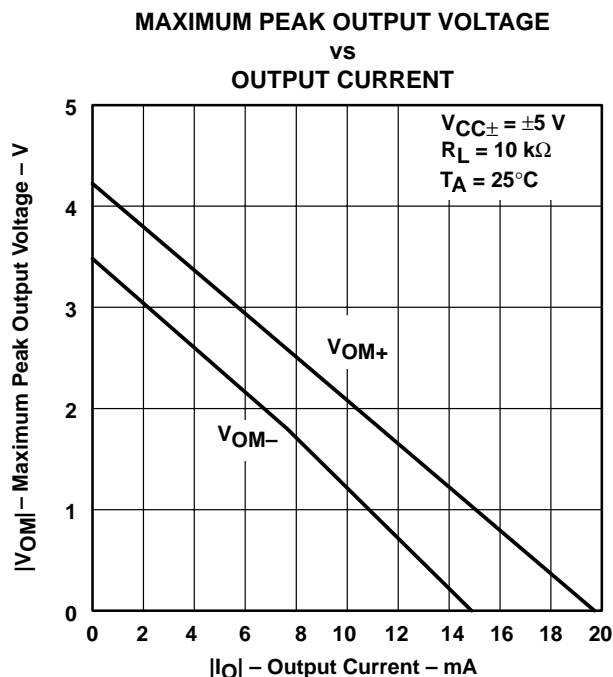

Figure 25

† Data at high and low temperatures are applicable only within the rated operating free-air temperature ranges of the various devices.

**TL05x, TL05xA**  
**ENHANCED-JFET LOW-OFFSET**  
**OPERATIONAL AMPLIFIERS**

SLOS178A – FEBRUARY 1997 - REVISED FEBRUARY 2003

**TYPICAL CHARACTERISTICS**

**MAXIMUM PEAK OUTPUT VOLTAGE**  
**vs**  
**OUTPUT CURRENT**

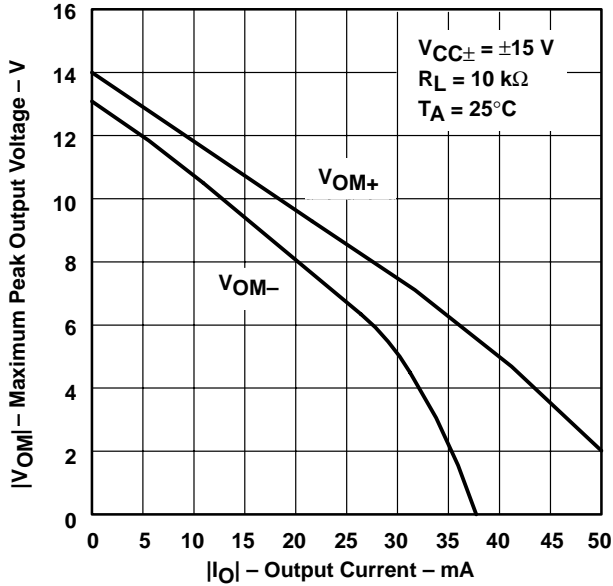

**Figure 26**

**MAXIMUM PEAK OUTPUT VOLTAGE†**  
**vs**  
**FREE-AIR TEMPERATURE**

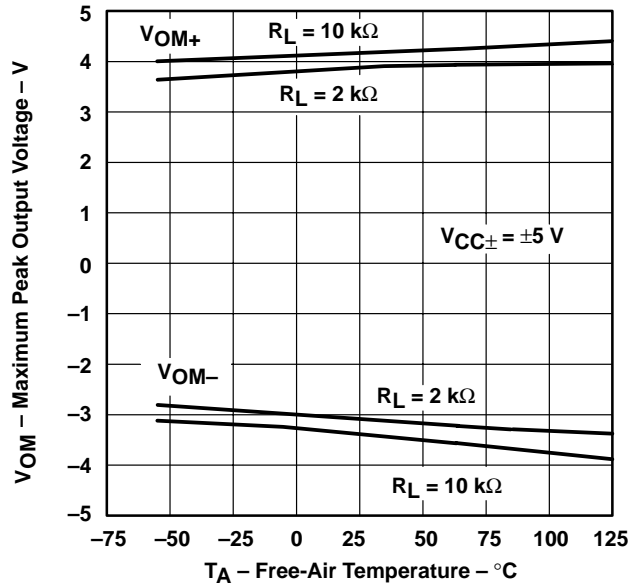

**Figure 27**

**MAXIMUM PEAK OUTPUT VOLTAGE†**  
**vs**  
**FREE-AIR TEMPERATURE**

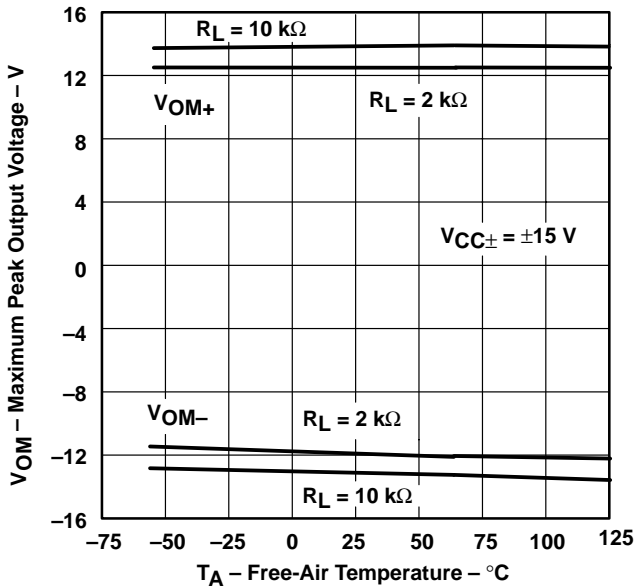

**Figure 28**

**LARGE-SIGNAL DIFFERENTIAL VOLTAGE**  
**AMPLIFICATION**  
**vs**  
**LOAD RESISTANCE**

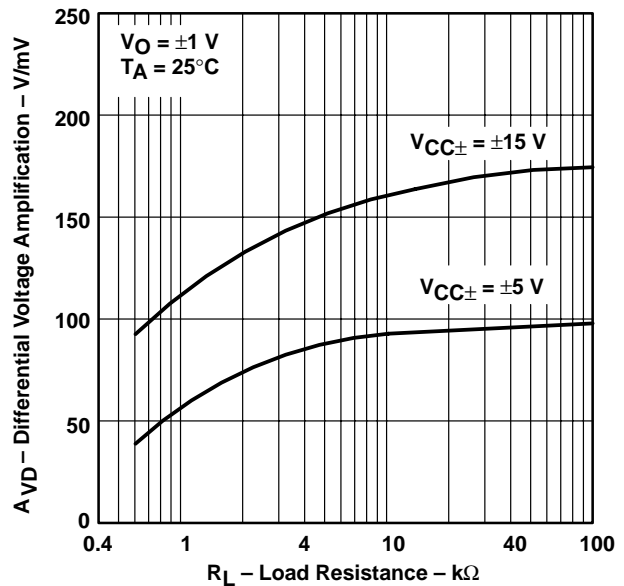

**Figure 29**

† Data at high and low temperatures are applicable only within the rated operating free-air temperature ranges of the various devices.



**TYPICAL CHARACTERISTICS  
 LARGE-SIGNAL DIFFERENTIAL VOLTAGE  
 AMPLIFICATION AND PHASE SHIFT  
 vs  
 FREQUENCY**

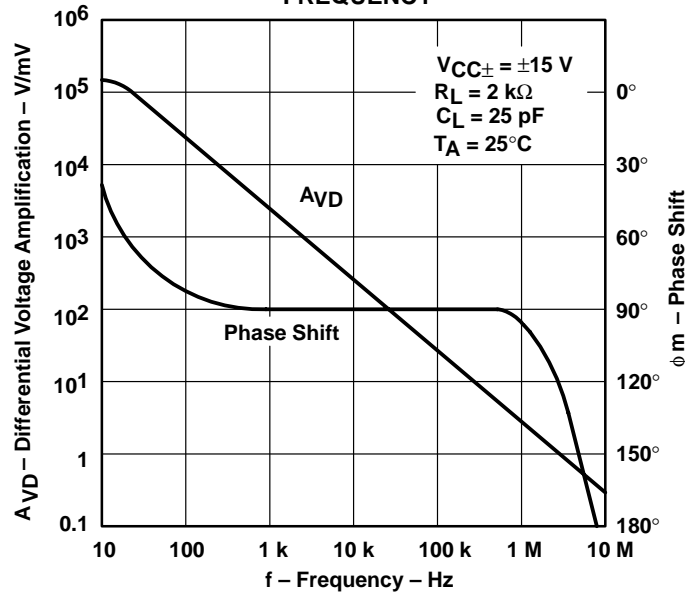

Figure 30

**TL051 AND TL052  
 LARGE-SIGNAL DIFFERENTIAL  
 VOLTAGE AMPLIFICATION†  
 vs  
 FREE-AIR TEMPERATURE**

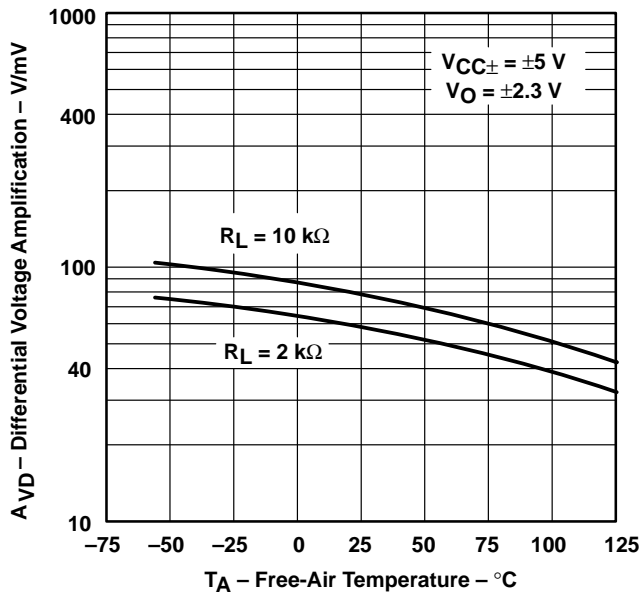

Figure 31

**TL054  
 LARGE-SIGNAL DIFFERENTIAL  
 VOLTAGE AMPLIFICATION†  
 vs  
 FREE-AIR TEMPERATURE**

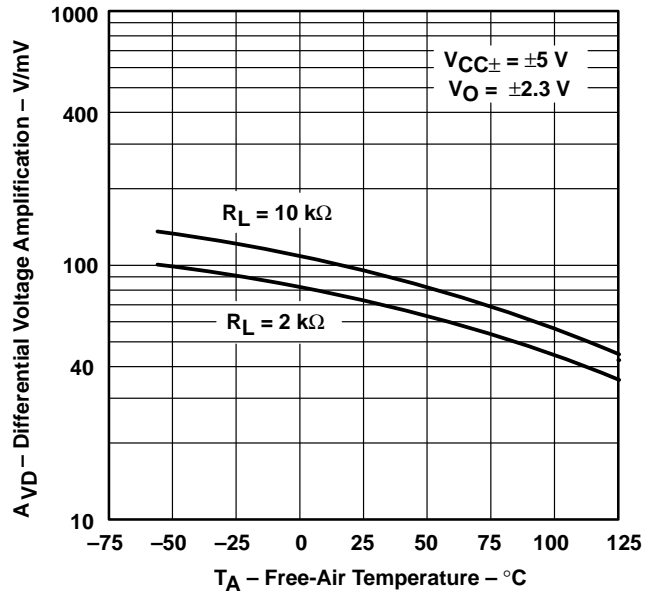

Figure 32

† Data at high and low temperatures are applicable only within the rated operating free-air temperature ranges of the various devices.

**TL05x, TL05xA**  
**ENHANCED-JFET LOW-OFFSET**  
**OPERATIONAL AMPLIFIERS**

SLOS178A – FEBRUARY 1997 - REVISED FEBRUARY 2003

**TYPICAL CHARACTERISTICS**

**LARGE-SIGNAL DIFFERENTIAL VOLTAGE AMPLIFICATION†**  
**vs**  
**FREE-AIR TEMPERATURE**

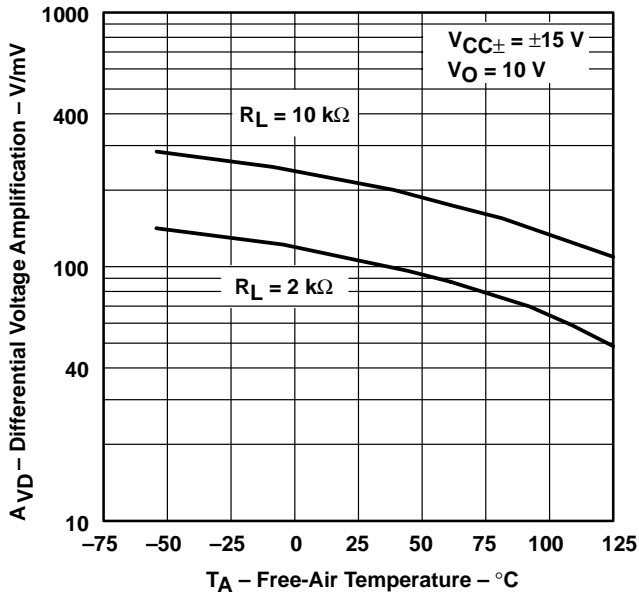

**Figure 33**

**COMMON-MODE REJECTION RATIO**  
**vs**  
**FREQUENCY**

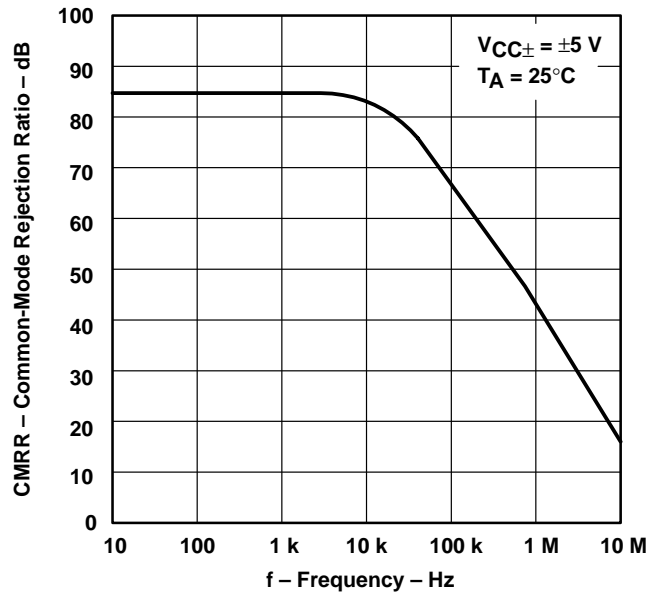

**Figure 34**

**COMMON-MODE REJECTION RATIO**  
**vs**  
**FREQUENCY**

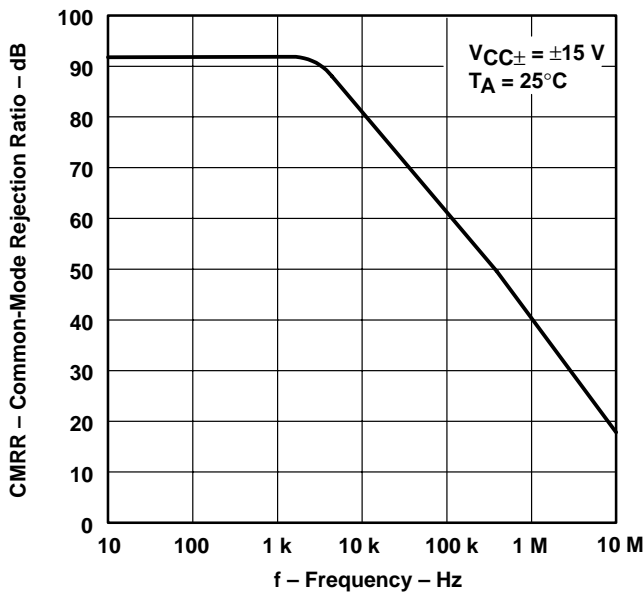

**Figure 35**

**COMMON-MODE REJECTION RATIO†**  
**vs**  
**FREE-AIR TEMPERATURE**

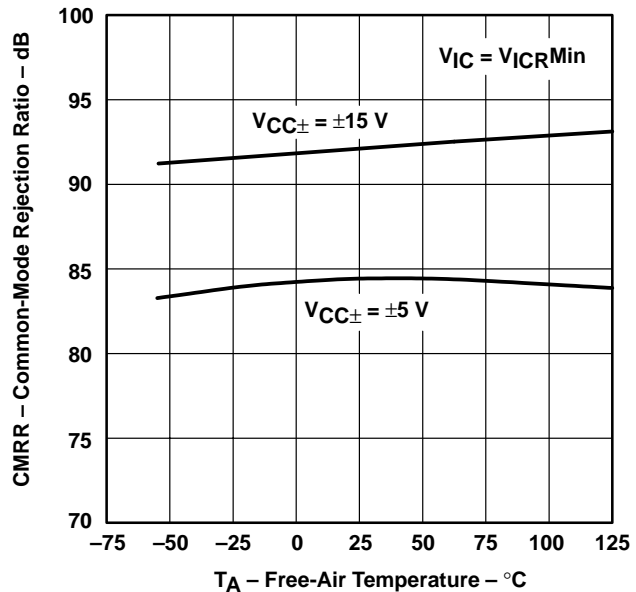
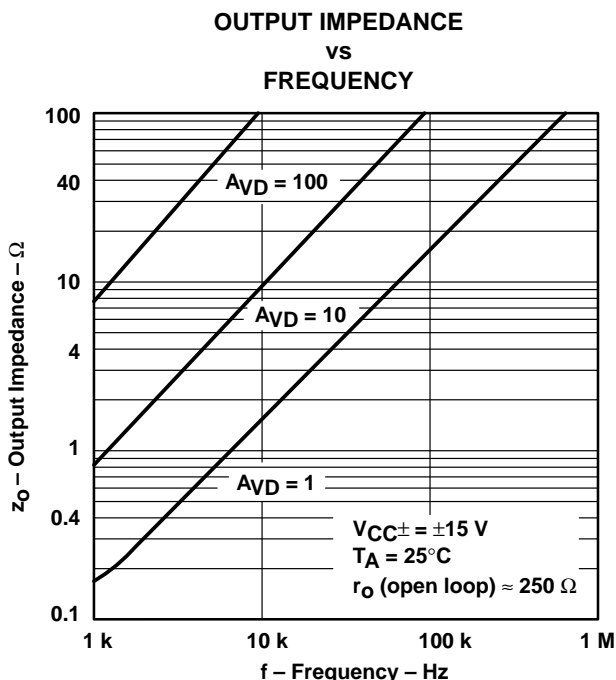

**Figure 36**

† Data at high and low temperatures are applicable only within the rated operating free-air temperature ranges of the various devices.



**TYPICAL CHARACTERISTICS**



**Figure 37**

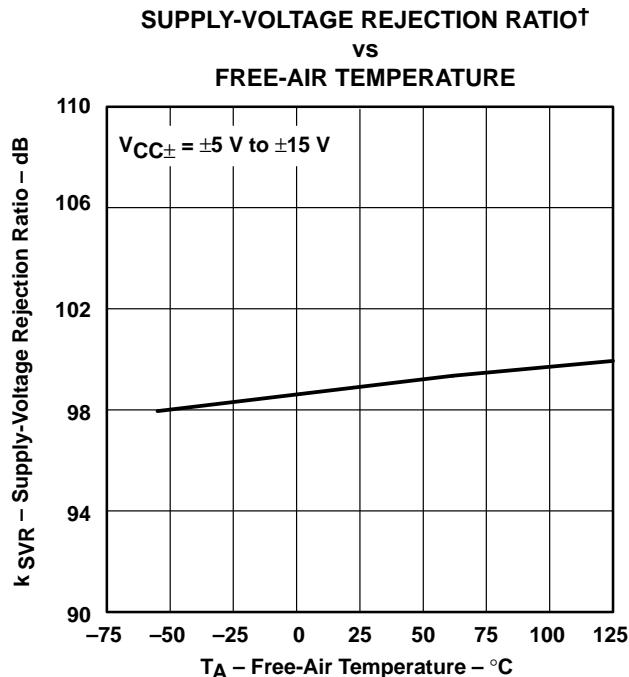

**Figure 38**

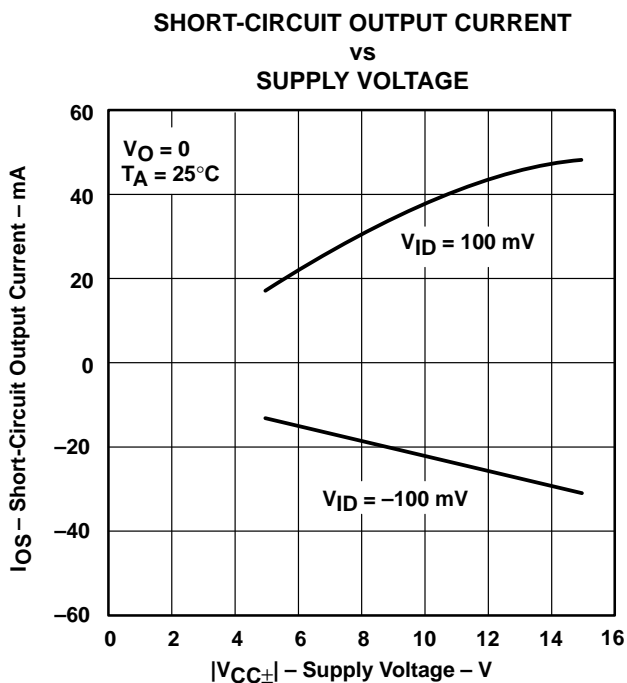

**Figure 39**

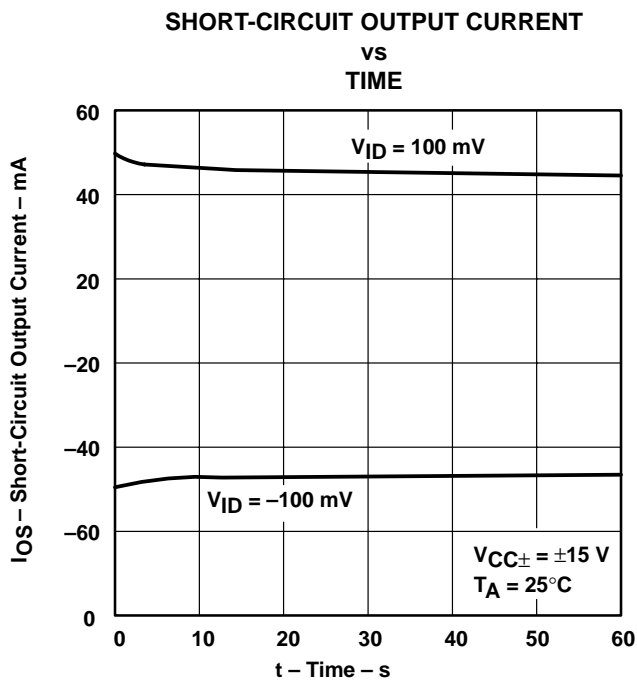

**Figure 40**

† Data at high and low temperatures are applicable only within the rated operating free-air temperature ranges of the various devices.

**TL05x, TL05xA**  
**ENHANCED-JFET LOW-OFFSET**  
**OPERATIONAL AMPLIFIERS**

SLOS178A – FEBRUARY 1997 - REVISED FEBRUARY 2003

**TYPICAL CHARACTERISTICS**

**SHORT-CIRCUIT OUTPUT CURRENT†**  
**vs**  
**FREE-AIR TEMPERATURE**

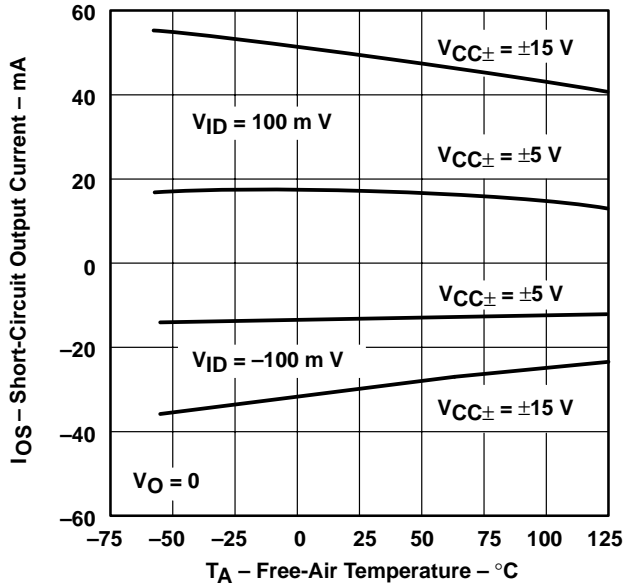

**Figure 41**

**TL051**  
**SUPPLY CURRENT†**  
**vs**  
**SUPPLY VOLTAGE**

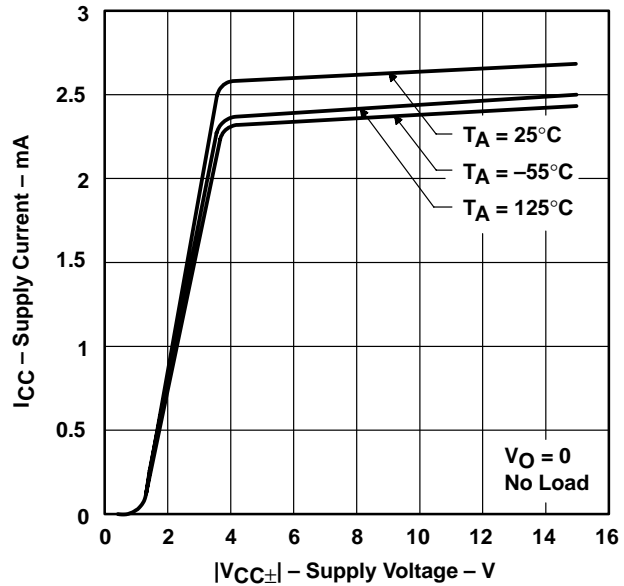

**Figure 42**

**TL052**  
**SUPPLY CURRENT†**  
**vs**  
**SUPPLY VOLTAGE**

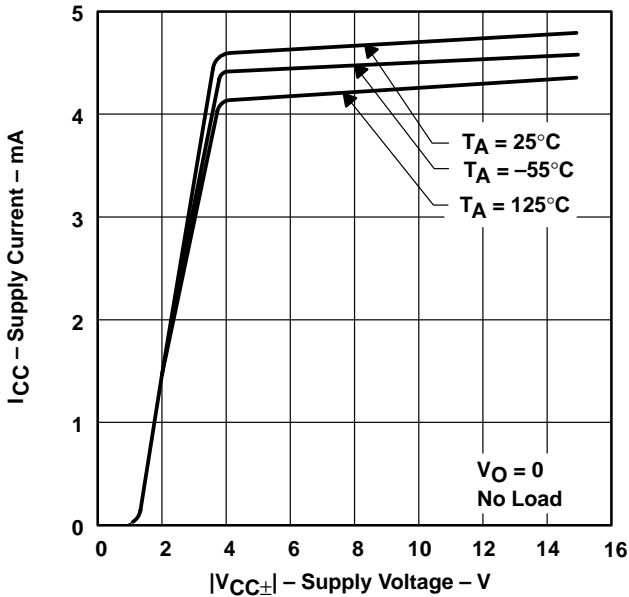

**Figure 43**

**TL054**  
**SUPPLY CURRENT†**  
**vs**  
**SUPPLY VOLTAGE**

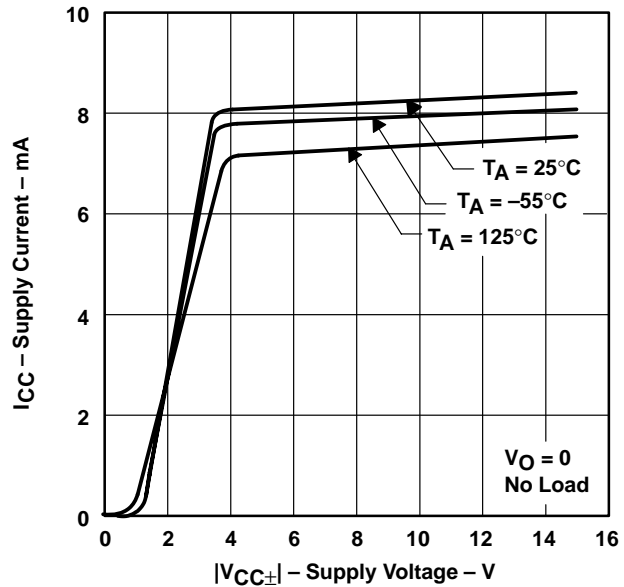
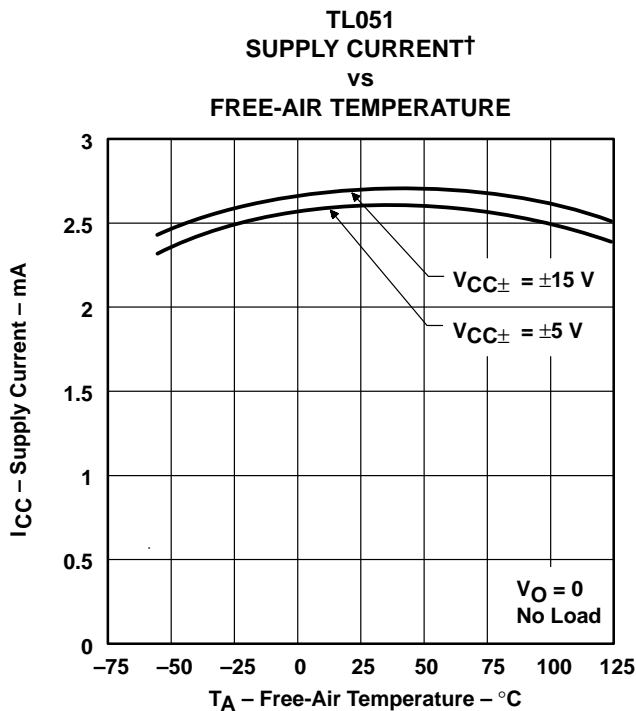

**Figure 44**

† Data at high and low temperatures are applicable only within the rated operating free-air temperature ranges of the various devices.



**TYPICAL CHARACTERISTICS**



**Figure 45**

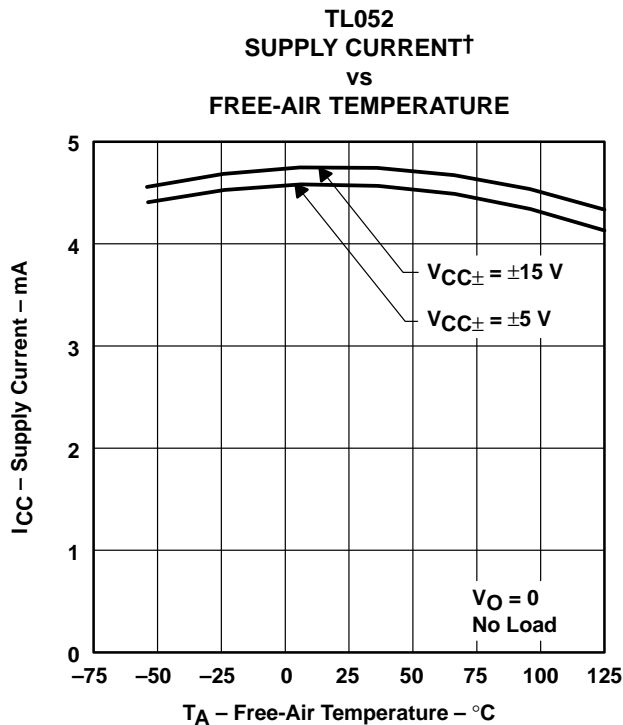

**Figure 46**

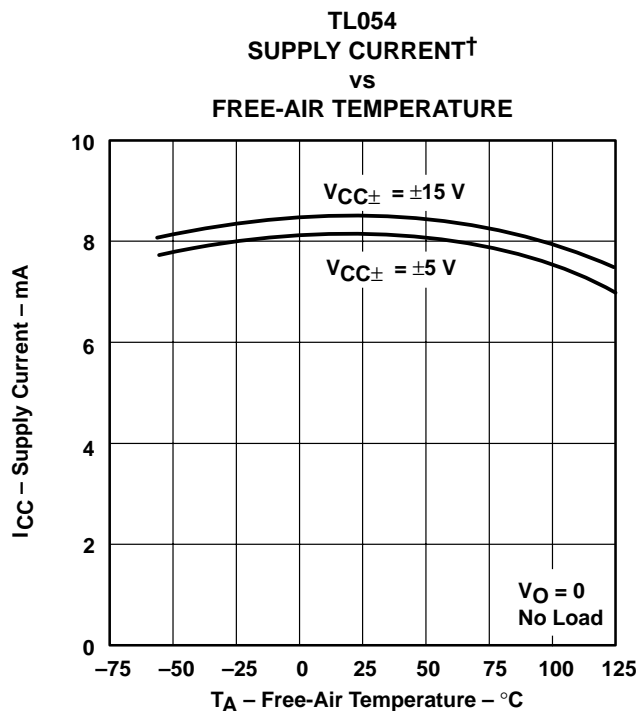

**Figure 47**

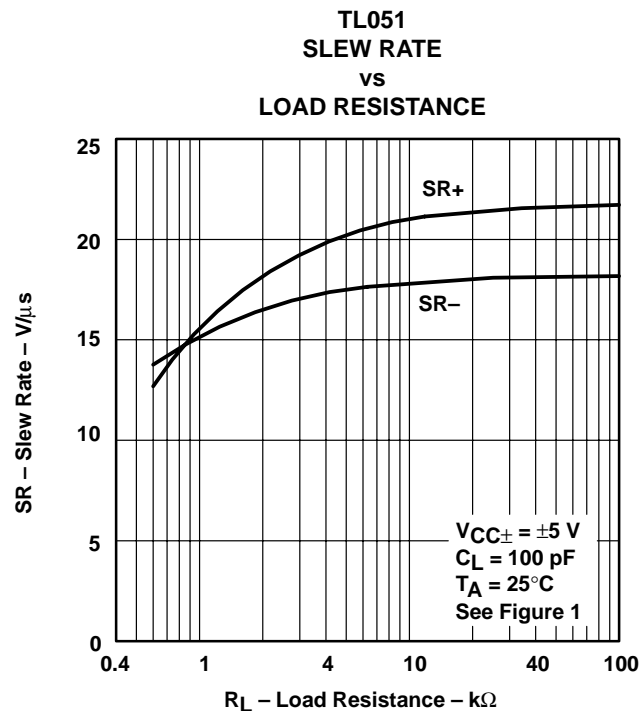

**Figure 48**

† Data at high and low temperatures are applicable only within the rated operating free-air temperature ranges of the various devices.

**TL05x, TL05xA**  
**ENHANCED-JFET LOW-OFFSET**  
**OPERATIONAL AMPLIFIERS**

SLOS178A – FEBRUARY 1997 - REVISED FEBRUARY 2003

**TYPICAL CHARACTERISTICS**

**TL052**  
**SLEW RATE**  
**vs**  
**LOAD RESISTANCE**

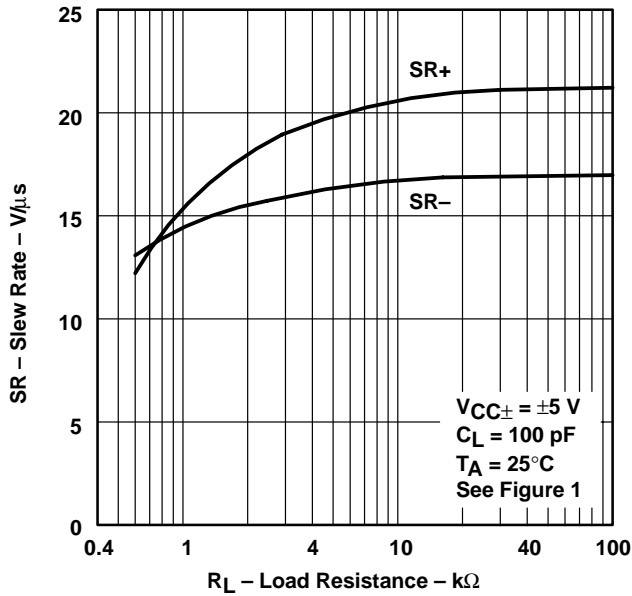

**Figure 49**

**TL054**  
**SLEW RATE**  
**vs**  
**LOAD RESISTANCE**

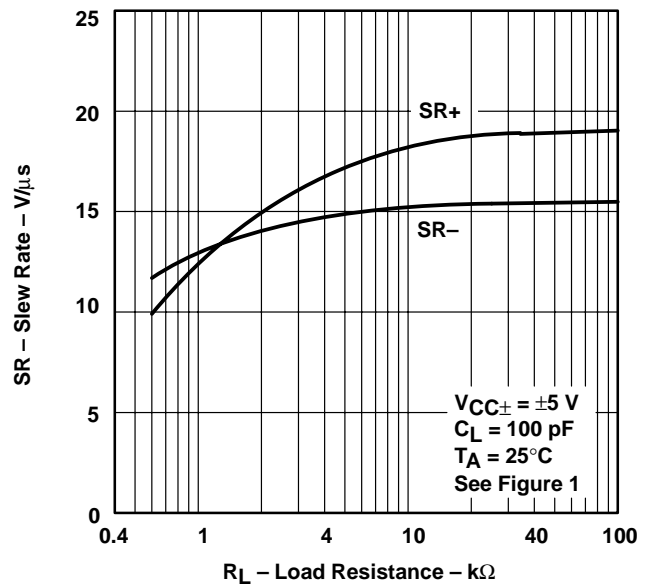

**Figure 50**

**TL051**  
**SLEW RATE**  
**vs**  
**LOAD RESISTANCE**

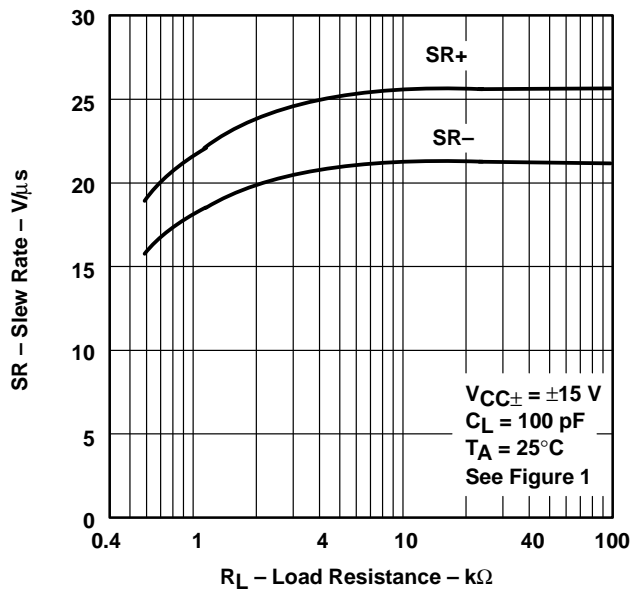

**Figure 51**

**TL052**  
**SLEW RATE**  
**vs**  
**LOAD RESISTANCE**

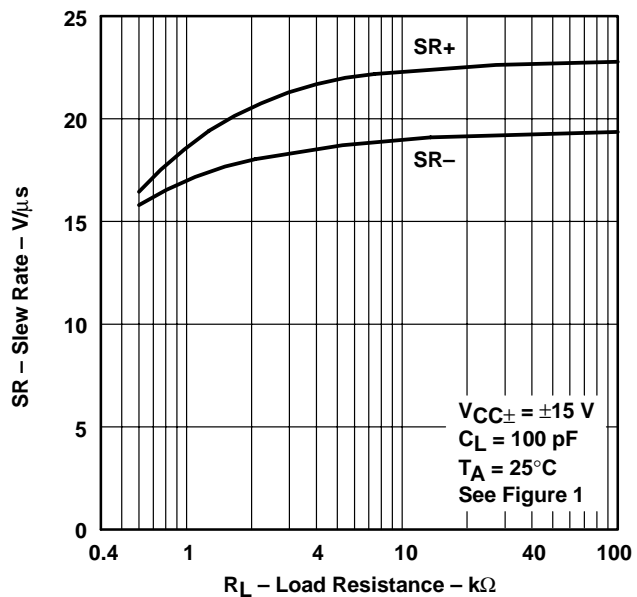

**Figure 52**



**TYPICAL CHARACTERISTICS**

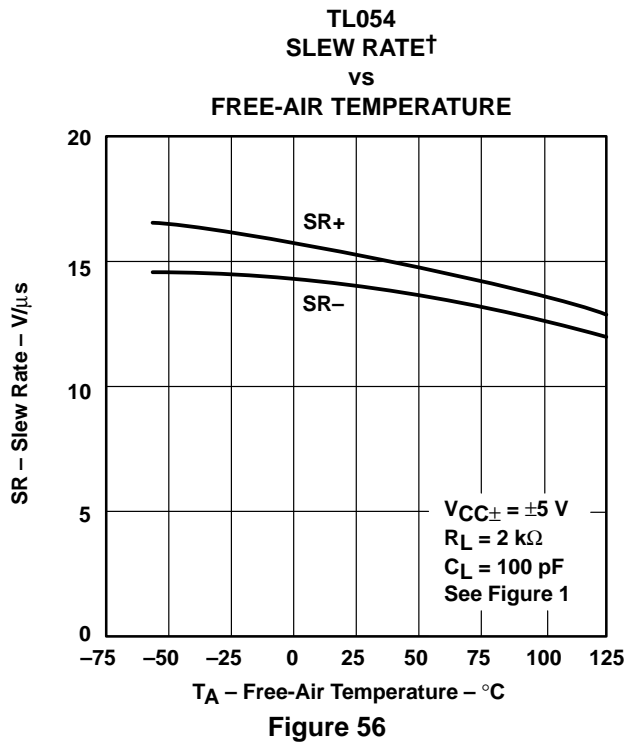
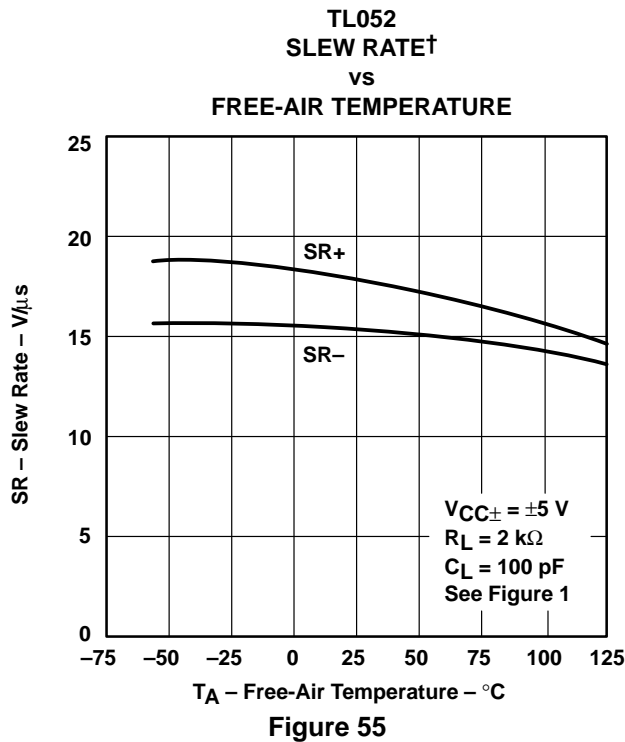
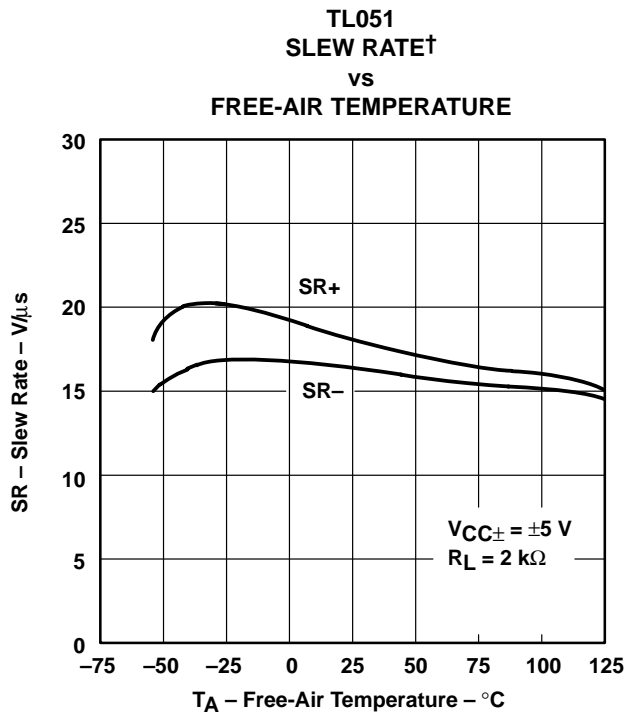
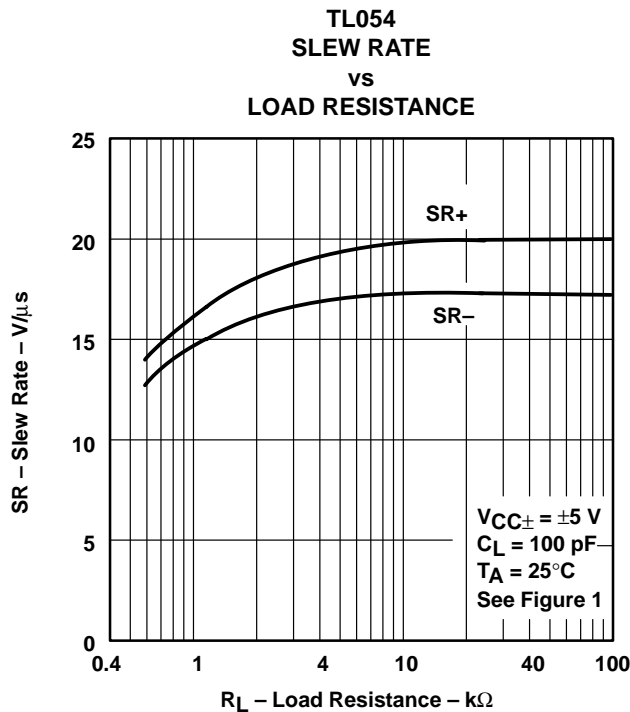

† Data at high and low temperatures are applicable only within the rated operating free-air temperature ranges of the various devices.

**TL05x, TL05xA**  
**ENHANCED-JFET LOW-OFFSET**  
**OPERATIONAL AMPLIFIERS**

SLOS178A – FEBRUARY 1997 - REVISED FEBRUARY 2003

**TYPICAL CHARACTERISTICS**

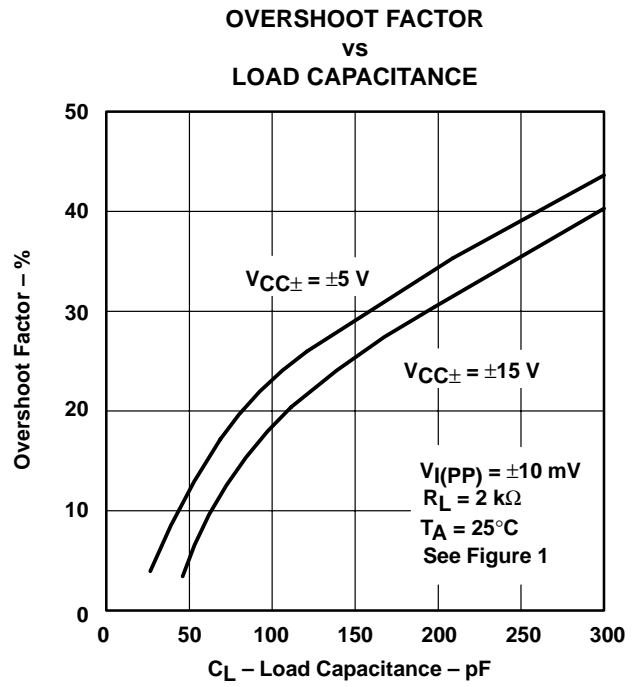
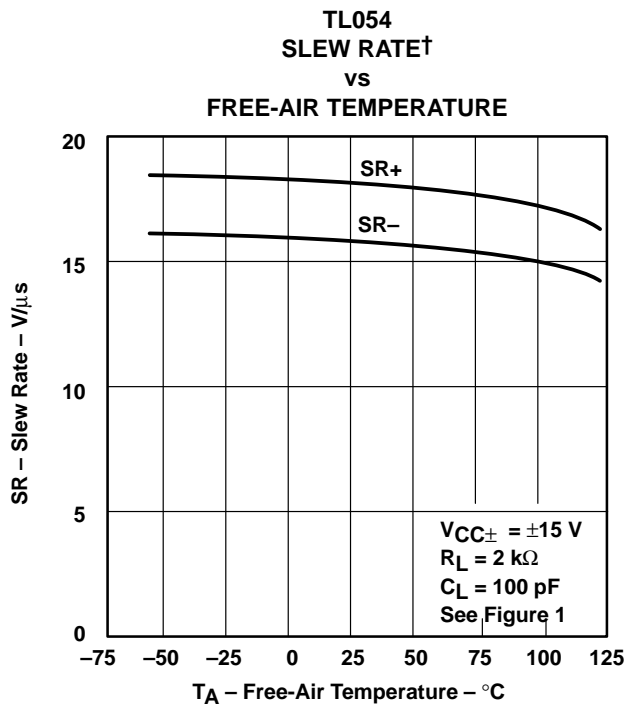
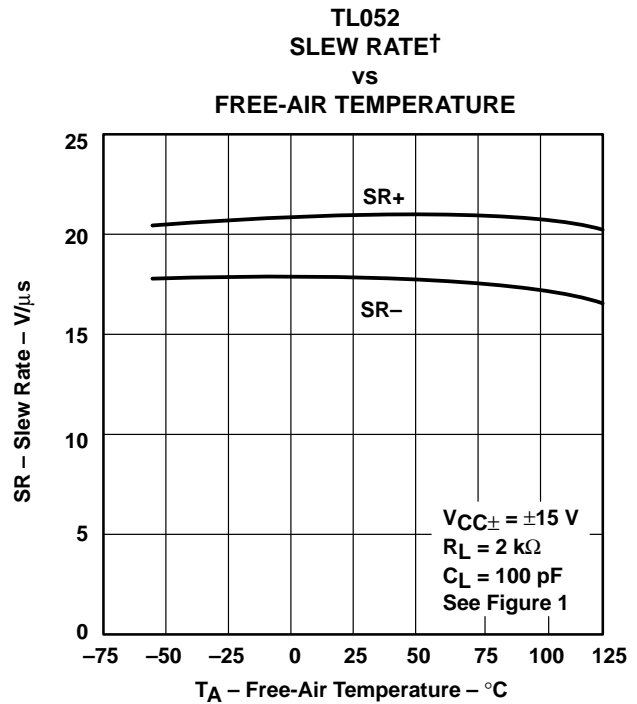
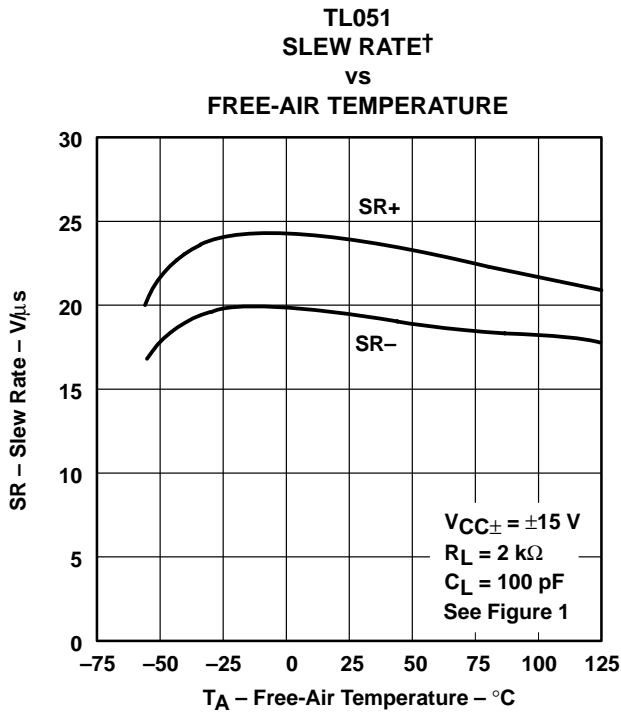

† Data at high and low temperatures are applicable only within the rated operating free-air temperature ranges of the various devices.



TYPICAL CHARACTERISTICS

TL051  
 EQUIVALENT INPUT NOISE VOLTAGE  
 VS  
 FREQUENCY

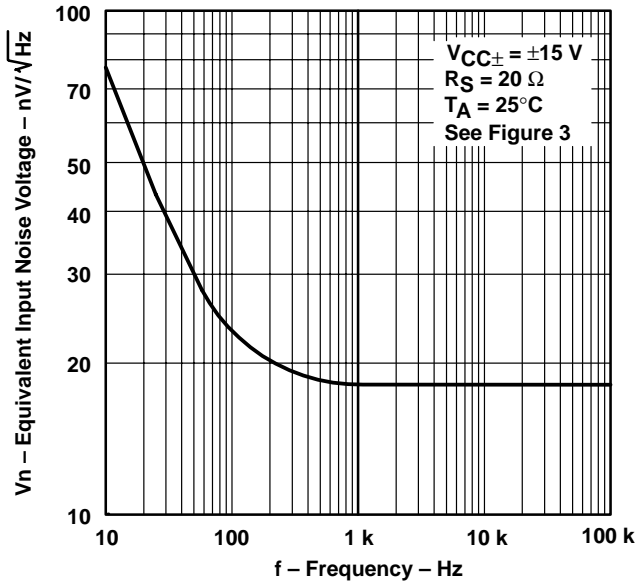

Figure 61

TL052 AND TL054  
 EQUIVALENT INPUT NOISE VOLTAGE  
 VS  
 FREQUENCY

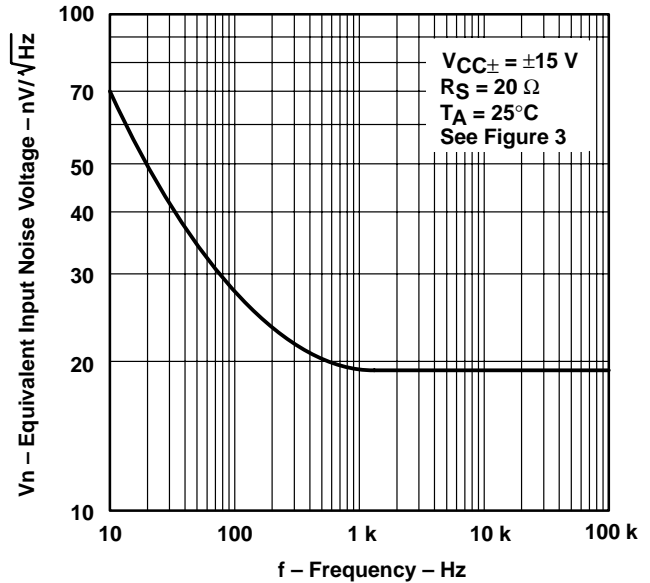

Figure 62

TOTAL HARMONIC DISTORTION  
 VS  
 FREQUENCY

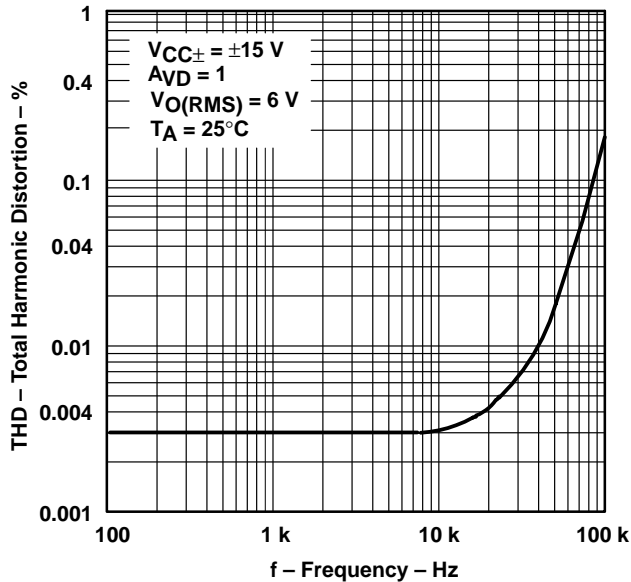

Figure 63

TL051  
 UNITY-GAIN BANDWIDTH  
 VS  
 SUPPLY VOLTAGE

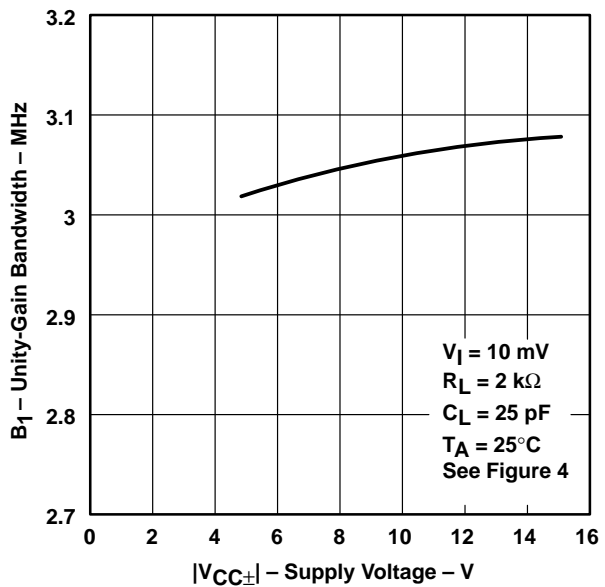
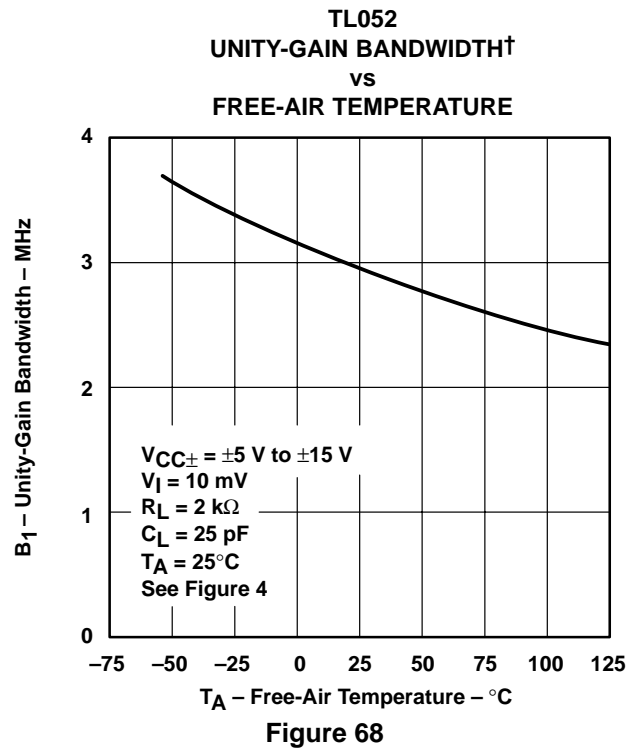
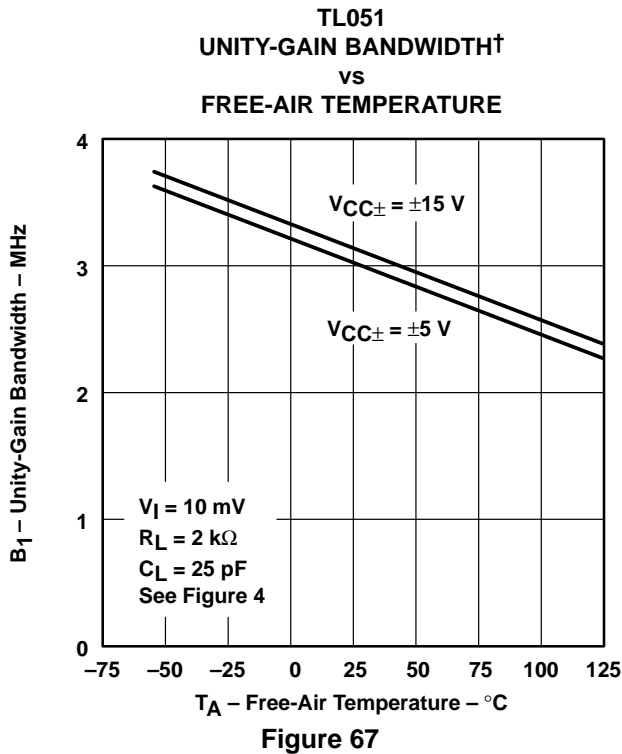
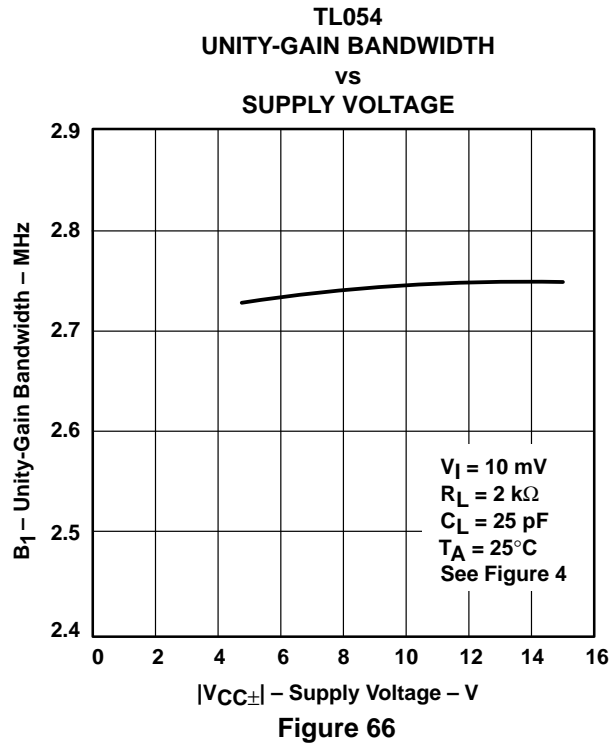
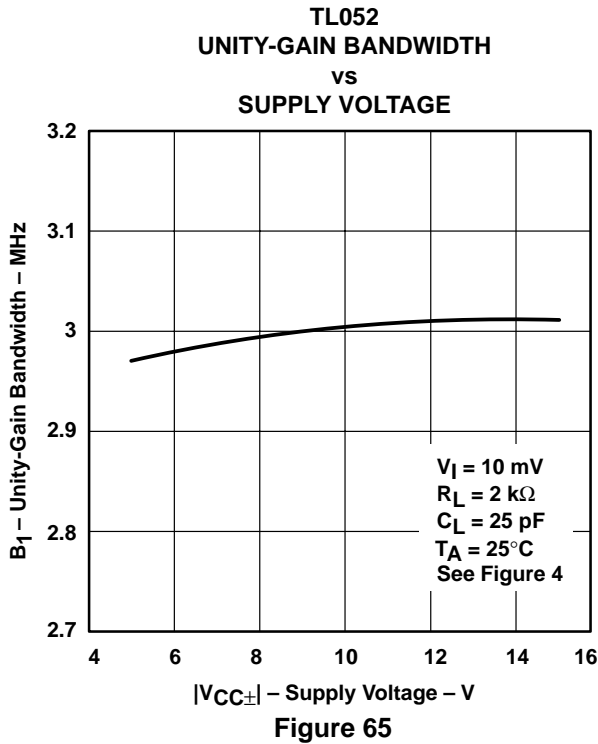

Figure 64

**TL05x, TL05xA**  
**ENHANCED-JFET LOW-OFFSET**  
**OPERATIONAL AMPLIFIERS**

SLOS178A – FEBRUARY 1997 - REVISED FEBRUARY 2003

**TYPICAL CHARACTERISTICS**



† Data at high and low temperatures are applicable only within the rated operating free-air temperature ranges of the various devices.



**TYPICAL CHARACTERISTICS**

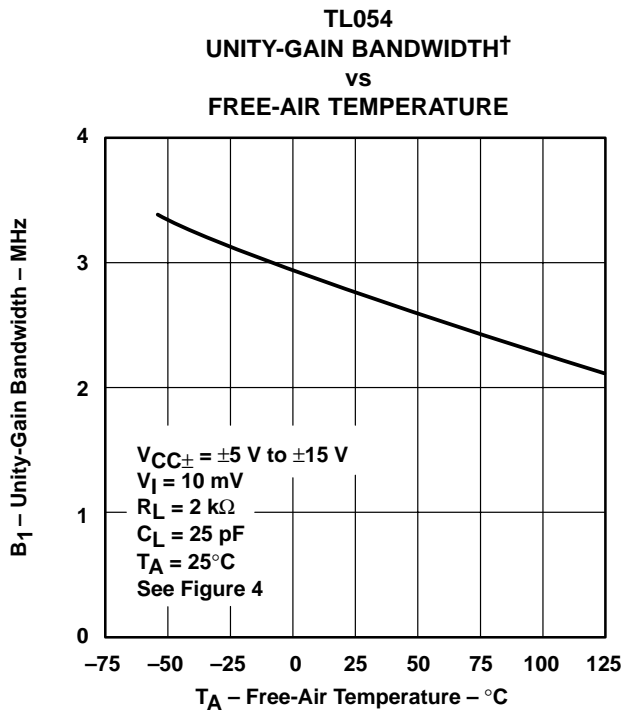

**Figure 69**

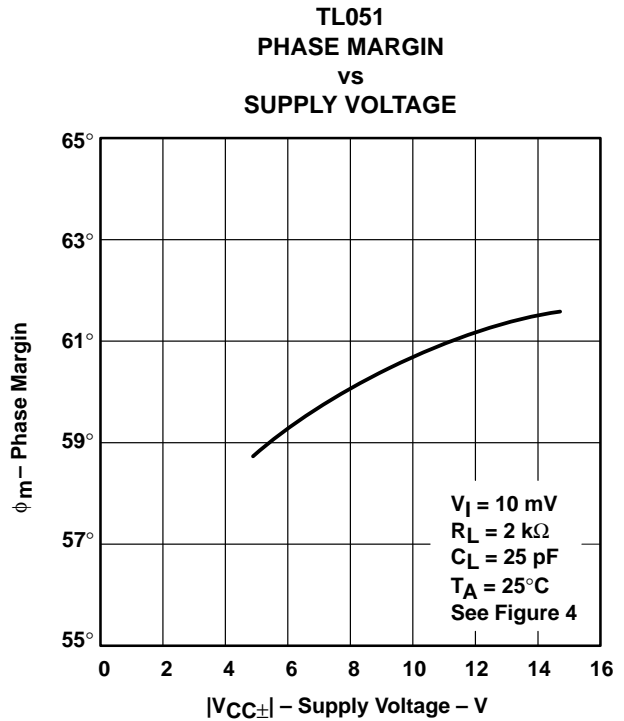

**Figure 70**

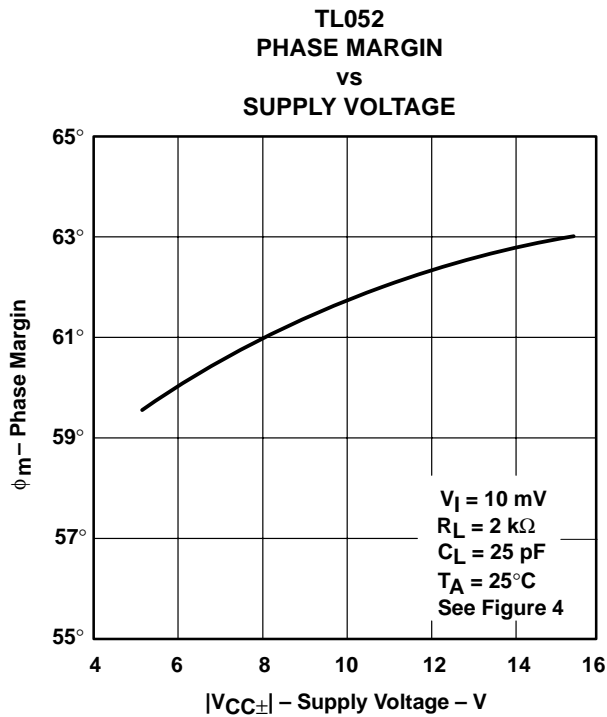

**Figure 71**

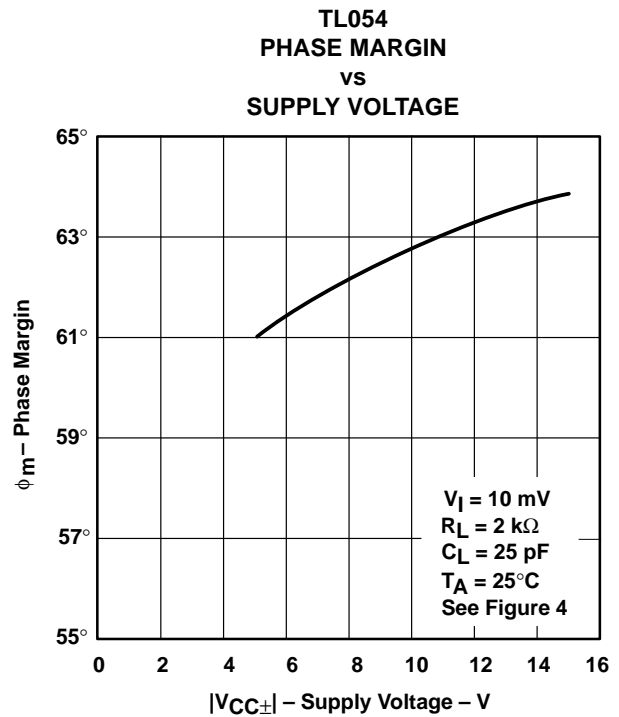

**Figure 72**

† Data at high and low temperatures are applicable only within the rated operating free-air temperature ranges of the various devices.

**TL05x, TL05xA**  
**ENHANCED-JFET LOW-OFFSET**  
**OPERATIONAL AMPLIFIERS**

SLOS178A – FEBRUARY 1997 - REVISED FEBRUARY 2003

**TYPICAL CHARACTERISTICS**

**TL051**  
**PHASE MARGIN†**  
**vs**  
**LOAD CAPACITANCE**

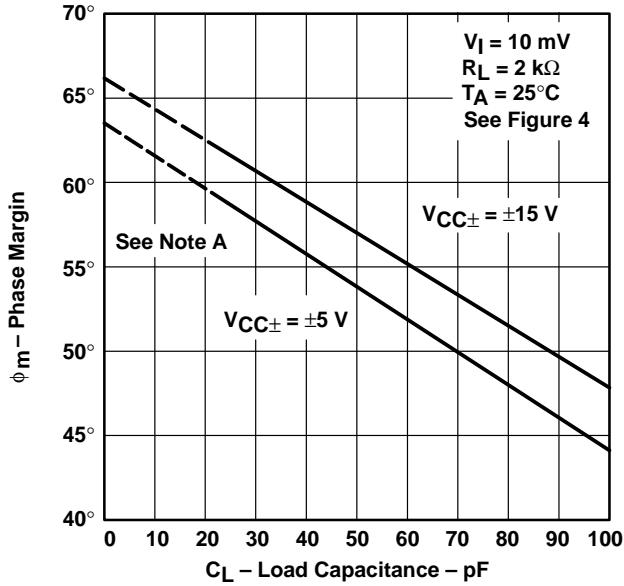

**Figure 73**

**TL052**  
**PHASE MARGIN†**  
**vs**  
**LOAD CAPACITANCE**

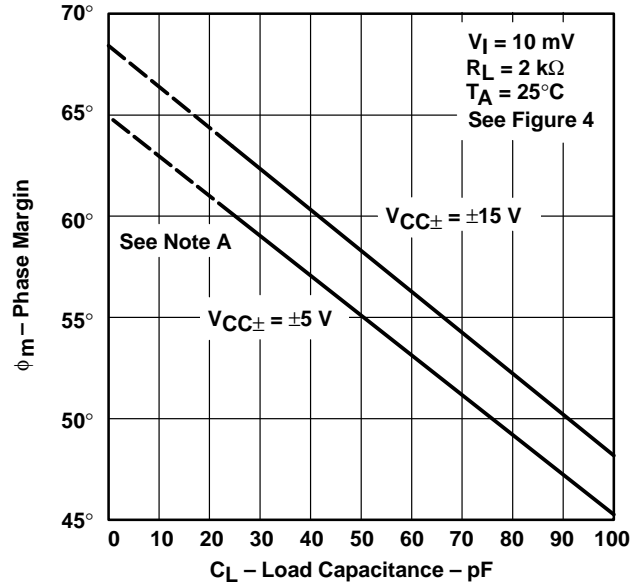

**Figure 74**

**TL054**  
**PHASE MARGIN†**  
**vs**  
**LOAD CAPACITANCE**

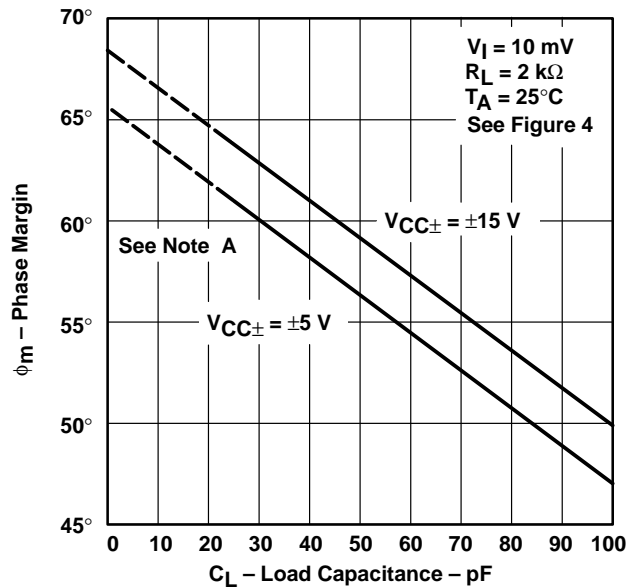

**Figure 75**

† Values of phase margin below a load capacitance of 25 pF were estimated.

**TYPICAL CHARACTERISTICS**

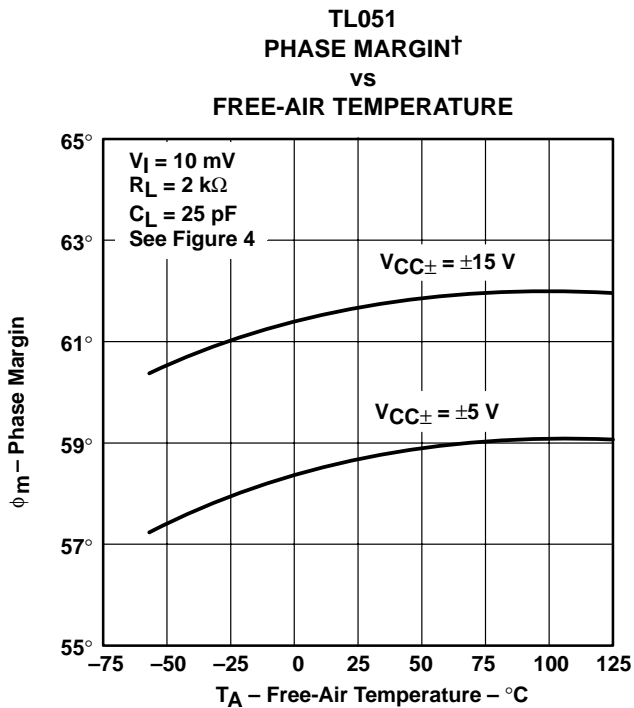

**Figure 76**

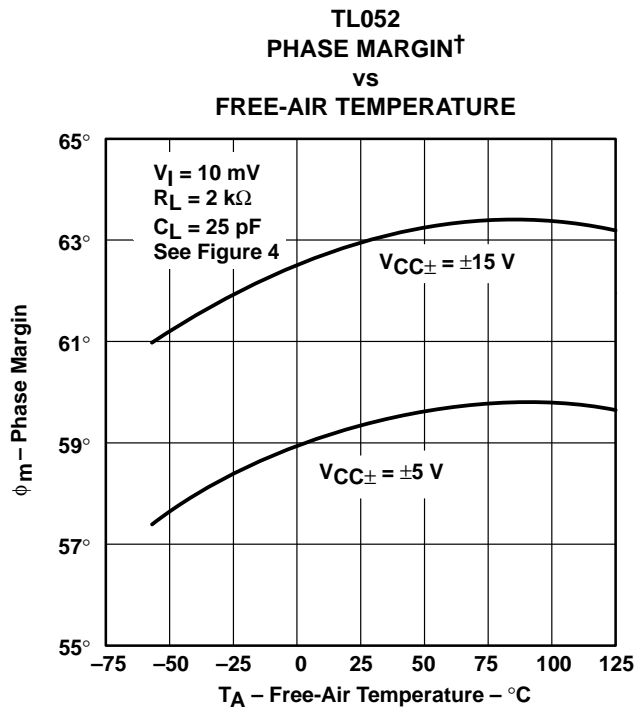

**Figure 77**

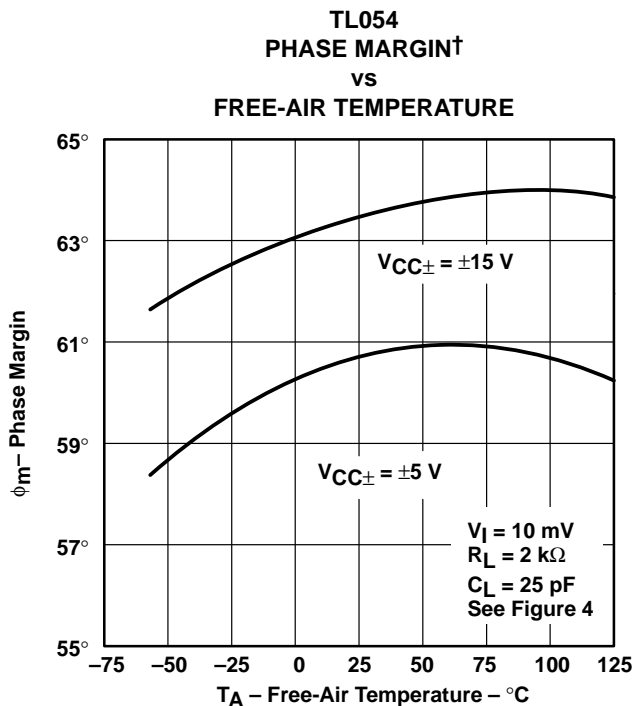

**Figure 78**

† Data at high and low temperatures are applicable only within the rated operating free-air temperature ranges of the various devices.

# TL05x, TL05xA ENHANCED-JFET LOW-OFFSET OPERATIONAL AMPLIFIERS

SLOS178A – FEBRUARY 1997 - REVISED FEBRUARY 2003

## TYPICAL CHARACTERISTICS

VOLTAGE-FOLLOWER  
SMALL-SIGNAL  
PULSE RESPONSE

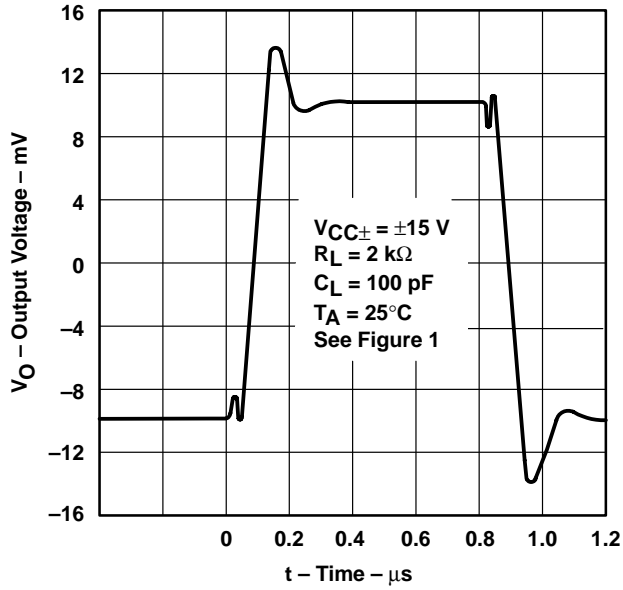

Figure 79

VOLTAGE-FOLLOWER  
LARGE-SIGNAL  
PULSE RESPONSE

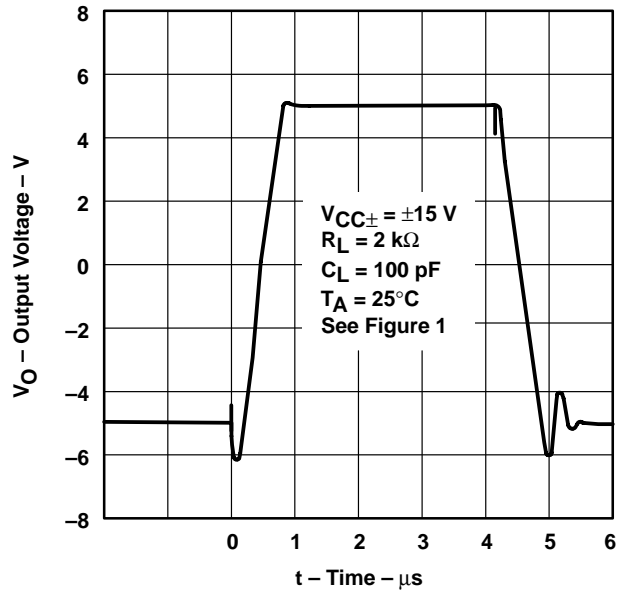
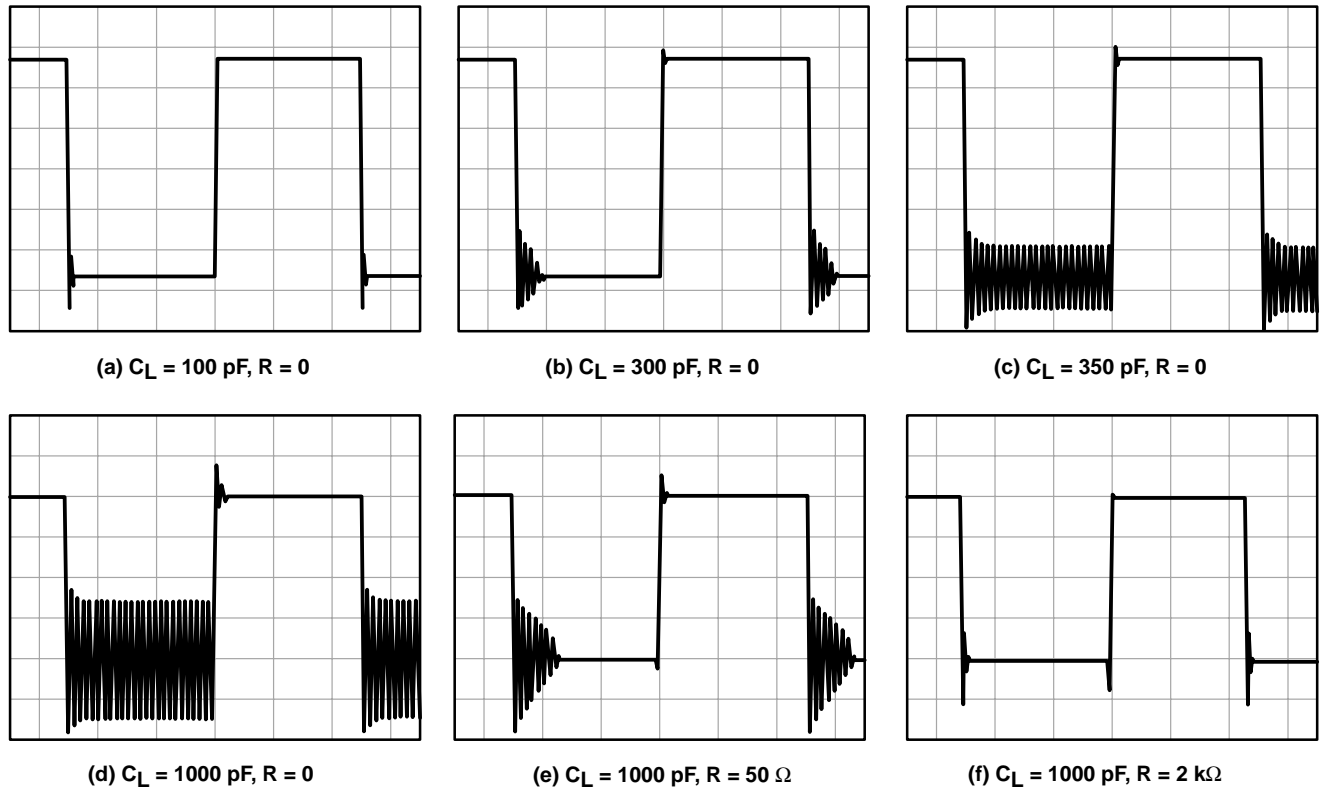

Figure 80

**APPLICATION INFORMATION**

**output characteristics**

All operating characteristics (except bandwidth and phase margin) are specified with 100-pF load capacitance. The TL05x and TL05xA drive higher capacitive loads; however, as the load capacitance increases, the resulting response pole occurs at lower frequencies, causing ringing, peaking, or even oscillation. The value of the load capacitance at which oscillation occurs varies with production lots. If an application appears to be sensitive to oscillation due to load capacitance, adding a small resistance in series with the load should alleviate the problem. Capacitive loads of 1000 pF, and larger, may be driven if enough resistance is added in series with the output (see Figure 81 and Figure 82).



**Figure 81. Effect of Capacitive Loads**

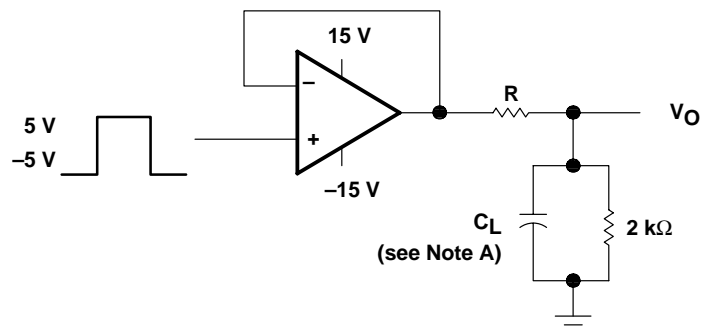

NOTE A:  $C_L$  includes fixture capacitance.

**Figure 82. Test Circuit for Output Characteristics**

# TL05x, TL05xA ENHANCED-JFET LOW-OFFSET OPERATIONAL AMPLIFIERS

SLOS178A – FEBRUARY 1997 - REVISED FEBRUARY 2003

## APPLICATION INFORMATION

### input characteristics

The TL05x and TL05xA are specified with a minimum and a maximum input voltage that, if exceeded at either input, could cause the device to malfunction.

Because of the extremely high input impedance and resulting low-bias current requirements, the TL05x and TL05xA are well suited for low-level signal processing; however, leakage currents on printed-circuit boards and sockets easily can exceed bias current requirements and cause degradation in system performance. It is good practice to include guard rings around inputs (see Figure 83). These guards should be driven from a low-impedance source at the same voltage level as the common-mode input.

Unused amplifiers should be connected as grounded unity-gain followers to avoid possible oscillation.

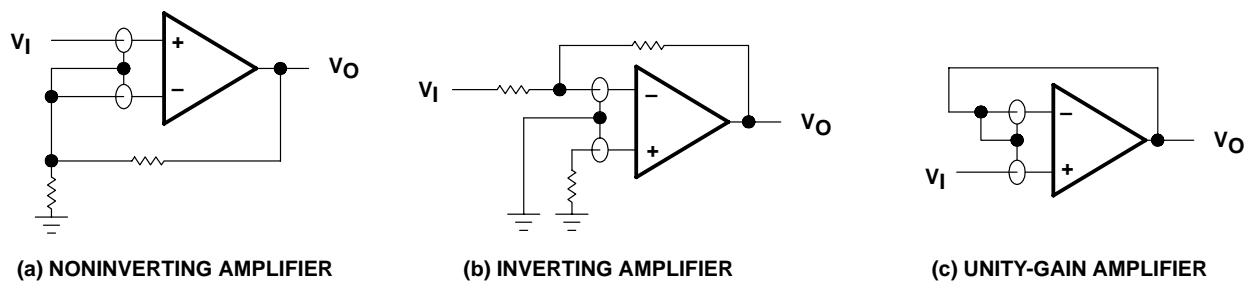

Figure 83. Use of Guard Rings

### noise performance

The noise specifications in operational amplifier circuits are greatly dependent on the current in the first-stage differential amplifier. The low input-bias current requirements of the TL05x and TL05xA result in a very low current noise. This feature makes the devices especially favorable over bipolar devices when using values of circuit impedance greater than 50 k $\Omega$ .

**APPLICATION INFORMATION**

**phase meter**

The phase meter in Figure 84 produces an output voltage of 10 mV per degree of phase delay between the two input signals  $V_A$  and  $V_B$ . The reference signal  $V_A$  must be the same frequency as  $V_B$ . The TLC3702 comparators (U1) convert these two input sine waves into  $\pm 5$ -V square waves. Then, R1 and R4 provide level shifting prior to the SN74HC109 dual J-K flip flops.

Flip-flop U2B is connected as a toggle flip-flop and generates a square wave at one-half the frequency of  $V_B$ . Flip-flop U2A also produces a square wave at one-half the input frequency. The pulse duration of U2A varies from zero to one-half the period, where zero corresponds to zero phase delay between  $V_A$  and  $V_B$  and one-half the period corresponds to  $V_B$  lagging  $V_A$  by 360 degrees.

The output pulse from U2A causes the TLC4066 (U3) switch to charge the TL05x (U4) integrator capacitors C1 and C2. As the phase delay approaches 360 degrees, the output of U4A approximates a square wave, and U2A has an output of almost 2.5 V. U4B acts as a noninverting amplifier with a gain of 1.44 in order to scale the 0- to 2.5-V integrator output to a 0- to 3.6-V output range.

R8 and R10 provide output gain and zero-level calibration. This circuit operates over a 100-Hz to 10-kHz frequency range.

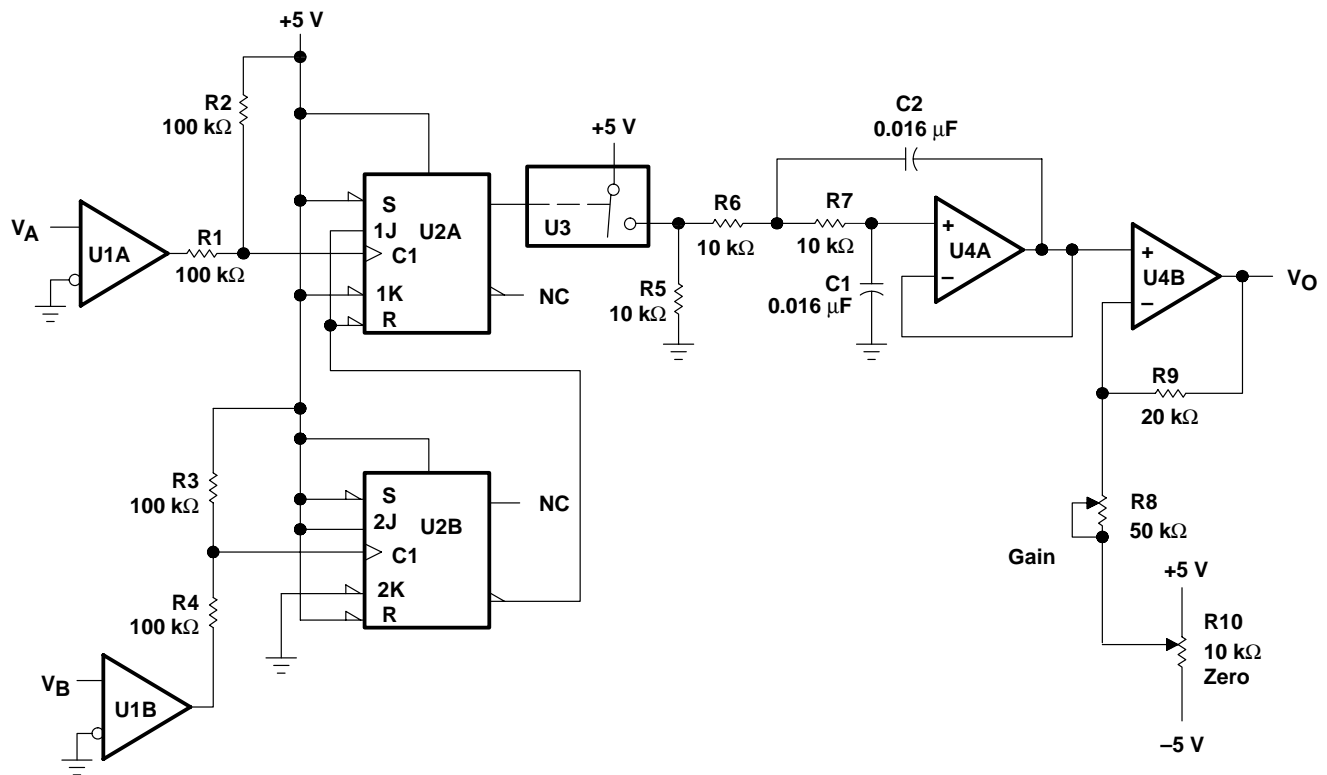

NOTE A: U1 = TLC3702;  $V_{CC\pm} = \pm 5$  V  
 U2 = SN74HC109  
 U3 = TLC4066  
 U4, U5 = TL05x;  $V_{CC\pm} = \pm 5$  V

**Figure 84. Phase Meter**

**TL05x, TL05xA**  
**ENHANCED-JFET LOW-OFFSET**  
**OPERATIONAL AMPLIFIERS**

SLOS178A – FEBRUARY 1997 - REVISED FEBRUARY 2003

**APPLICATION INFORMATION**

**precision constant-current source over temperature**

A precision current source (see Figure 85) benefits from the high input impedance and stability of Texas Instruments enhanced-JFET process. A low-current shunt regulator maintains 2.5 V between the inverting input and the output of the TL05x. The negative feedback then forces 2.5 V across the current-setting resistor R; therefore, the current to the load simply is 2.5 V divided by R.

Possible choices for the shunt regulator include the LM385, LM1004, and LM1009. If the regulator's cathode connects to the operational amplifier output, this circuit sources load current. Similarly, if the cathode connects to the inverting input, the circuit sinks current from the load. To minimize output current change with temperature, R should be a metal film resistor with a low temperature coefficient. Also, this circuit must be operated with split-voltage supplies.

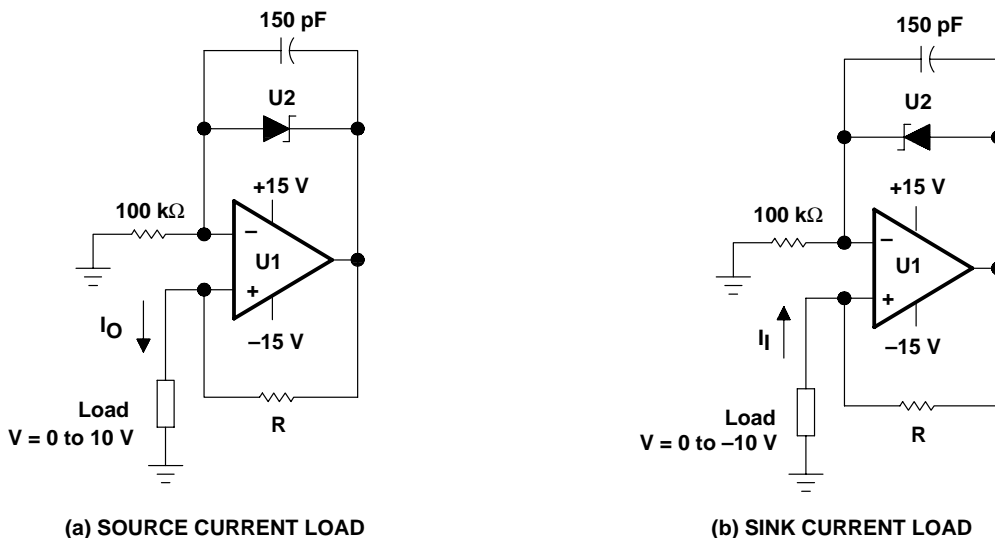

NOTE A: U1 = 1/2 TL05x  
 U2 = LM385, LM1004, or LM1009 voltage reference  
 $I = \frac{2.5 \text{ V}}{R}$ , R = Low-temperature-coefficient metal-film resistor

**Figure 85. Precision Constant-Current Source**

**APPLICATION INFORMATION**

**instrumentation amplifier with adjustable gain/null**

The instrumentation amplifier in Figure 86 benefits greatly from the high input impedance and stable input offset voltage of the TL05xA. Amplifiers U1A, U1B, and U2A form the actual instrumentation amplifier, while U2B provides offset null. Potentiometer R1 provides gain adjustment. With R1 = 2 kΩ, the circuit gain equals 100, while with R1 = 200 kΩ, the circuit gain equals two. The following equation shows the instrumentation amplifier gain as a function of R1:

$$A_v = 1 + \left( \frac{R2 + R3}{R1} \right)$$

Readjusting the offset null is necessary when the circuit gain is changed. If U2B is needed for another application, R7 can be terminated at ground. The low input offset voltage of the TL05xA minimizes the dc error of the circuit. For best matching, all resistors should be one-percent tolerance. The matching between R4, R5, R6, and R7 controls the CMRR of this application.

The following equation shows the output voltages when the input voltage equals zero. This dc error can be nulled by adjusting the offset null potentiometer; however, any change in offset voltage over time or temperature also creates an error. To calculate the error from changes in offset, consider the three offset components in the equation as delta offsets, rather than initial offsets. The improved stability of Texas Instruments enhanced JFETs minimizes the error resulting from change in input offset voltage with time. Assuming V<sub>I</sub> equals zero, V<sub>O</sub> can be shown as a function of the offset voltage:

$$V_O = V_{IO2} \left[ \left( 1 + \frac{R3}{R1} \right) \left( \frac{R7}{R5 + R7} \right) \left( 1 + \frac{R6}{R4} \right) + \frac{R2}{R1} \left( \frac{R6}{R4} \right) \right] - V_{IO1} \left[ \frac{R3}{R1} \left( \frac{R7}{R5 + R7} \right) \left( 1 + \frac{R6}{R4} \right) + \frac{R6}{R4} \left( 1 + \frac{R2}{R1} \right) \right] + V_{IO3} \left( 1 + \frac{R6}{R4} \right)$$

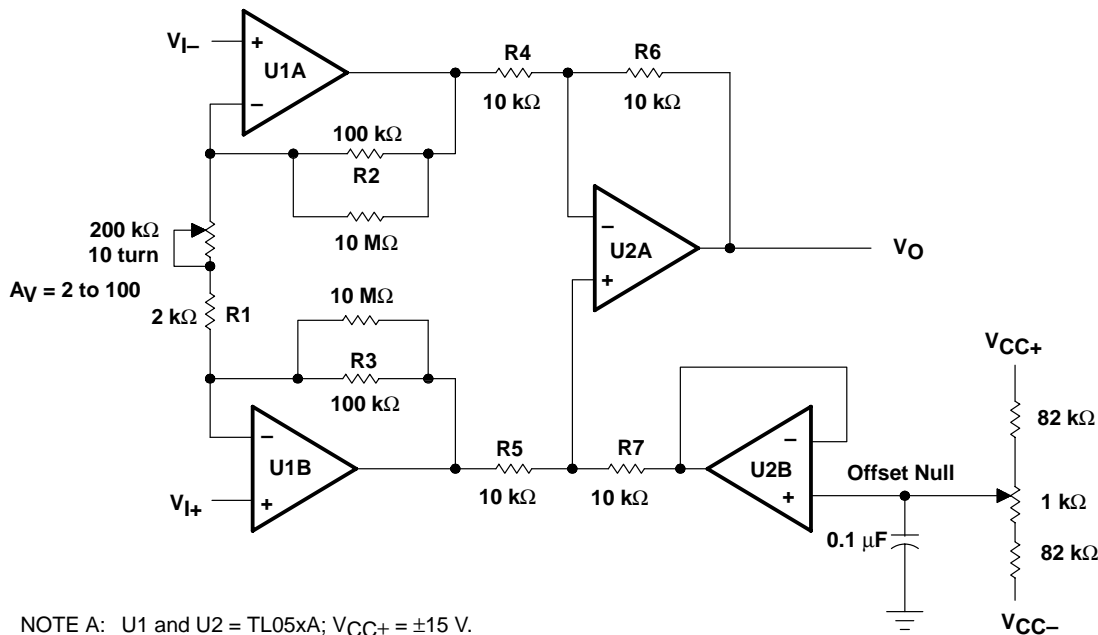

**Figure 86. Instrumentation Amplifier**

**APPLICATION INFORMATION**

**high input impedance log amplifier**

The low input offset voltage and high input impedance of the TL05xA creates a precision log amplifier (see Figure 87). IC1 is a 2.5-V, low-current precision, shunt regulator. Transistors Q1 and Q2 must be a closely matched npn pair. For best performance over temperature, R4 should be a metal-film resistor with a low temperature coefficient.

In this circuit, U1A serves as a high-impedance unity-gain buffer. Amplifier U1B converts the input voltage to a current through R1 and Q1. Amplifier U1C, IC1, and R4 form a 1-μA temperature-stable current source that sets the base-emitter voltage of Q2. U1D amplifies the difference between the base-emitter voltage of Q1 and Q2 (see Figure 88). The output voltage is given by the following equation:

$$V_O = -\left[1 + \frac{R_6}{R_5}\right] \frac{kT}{q} \left[ \ln \frac{V_I}{(R_1 \times 1 \times 10^{-6})} \right]$$

where  $k = 1.38 \times 10^{-23}$ ,  $q = 1.602 \times 10^{-19}$ , and T is Kelvin temperature

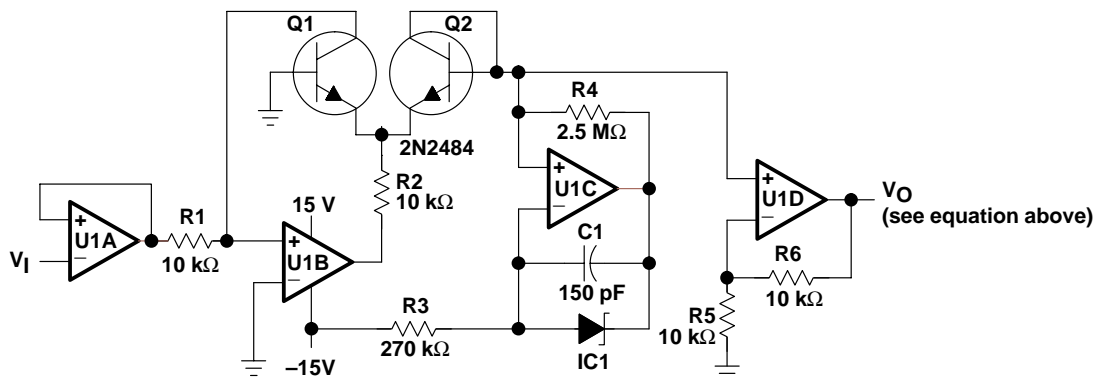

NOTE A: U1A through U1D = TL05xA. IC1 = LM385, LT1004, or LT1009 voltage reference

**Figure 87. Log Amplifier**

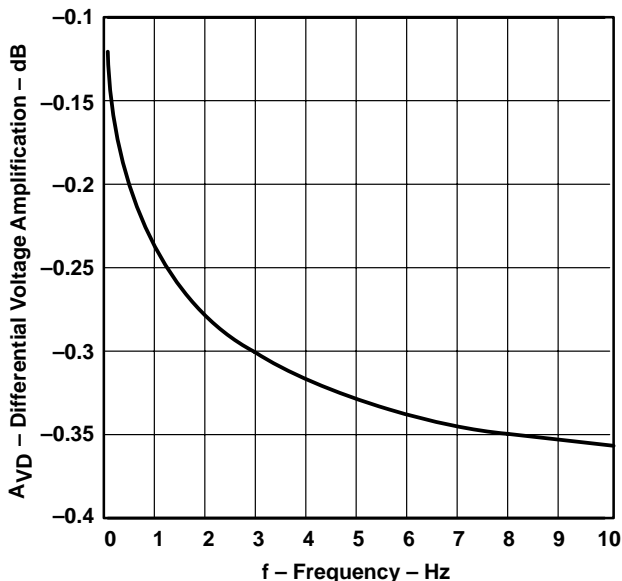

**Figure 88. Output Voltage vs Input Voltage for Log Amplifier**

**APPLICATION INFORMATION**

**analog thermometer**

By combining a current source that does not vary over temperature with an instrumentation amplifier, a precise analog thermometer can be built (see Figure 89). Amplifier U1A and IC1 establish a constant current through the temperature-sensing diode D1. For this section of the circuit to operate correctly, the TL05x must use split supplies, and R3 must be a metal-film resistor with a low temperature coefficient.

The temperature-sensitive voltage from the diode is compared to a temperature-stable voltage reference set by IC2. R4 should be adjusted to provide the correct output voltage when the diode is at a known temperature. Although this potentiometer resistance varies with temperature, the divider ratio of the potentiometer remains constant.

Amplifiers U1B, U2A, and U2B form the instrumentation amplifier that converts the difference between the diode and reference voltage to a voltage proportional to the temperature. With switch S1 closed, the amplifier gain equals 5 and the output voltage is proportional to temperature in degrees Celsius. With S1 open, the amplifier gain is 9 and the output is proportional to temperature in degrees Fahrenheit. Every time S1 is changed, R4 must be recalibrated. By setting S1 correctly, the output voltage equals 10 mV per degree (C or F).

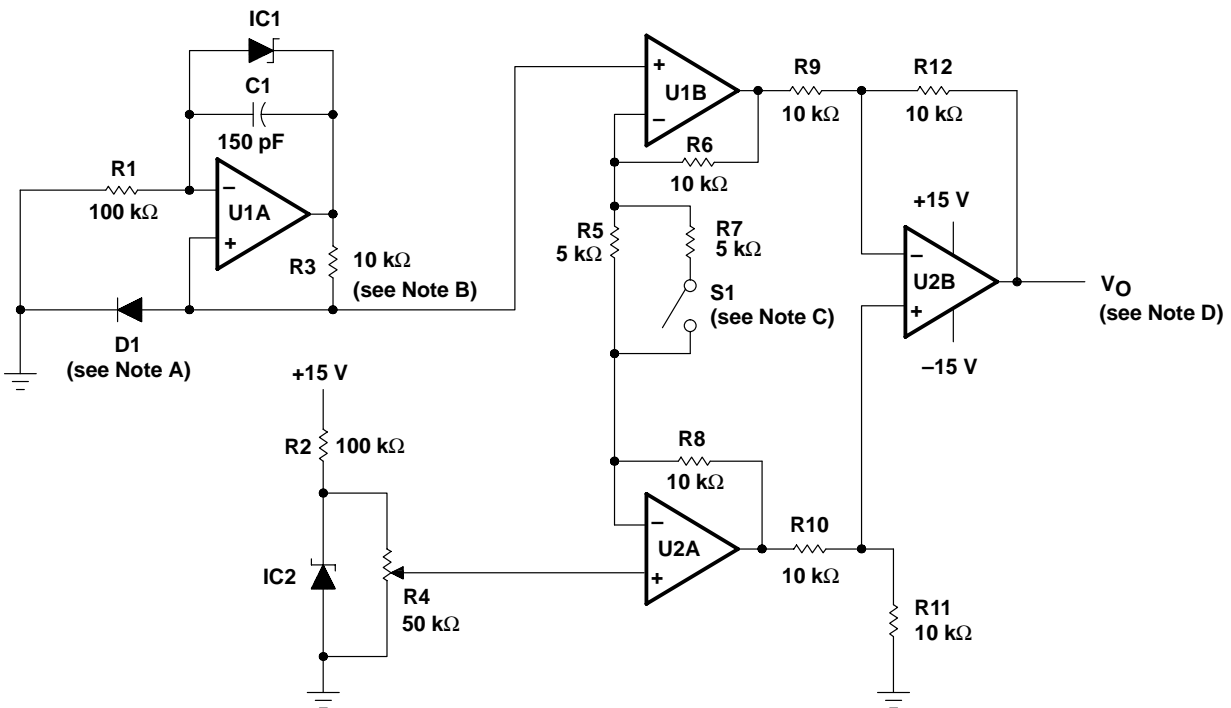

- NOTES: A. Temperature-sensing diode  $\approx (-2 \text{ mV}/^\circ\text{C})$   
 B. Metal-film resistor (low temperature coefficient)  
 C. Switch open for  $^\circ\text{F}$  and closed for  $^\circ\text{C}$   
 D.  $V_O \propto$  temperature; 10 mV/ $^\circ\text{C}$  or 10 mV/ $^\circ\text{F}$   
 E. U1, U2 = TL05x. IC1, IC2 = LM385, LT1004, or LT1009 voltage reference

**Figure 89. Analog Thermometer**

**APPLICATION INFORMATION**

**voltage-ratio-to-dB converter**

The application in Figure 90 measures the amplitude ratio of two signals, then converts the ratio to decibels (see Figure 91). The output voltage provides a resolution of 100 mV/dB. The two inputs can be either dc or sinusoidal ac signals. When using ac signals, both signals should be the same frequency or output glitches will occur. For measuring two input signals of different frequencies, extra filtering should be added after the rectifiers.

The circuit contains three low-offset TL05xA devices. Two of these devices provide the rectification and logarithmic conversion of the inputs. The third TL05xA forms an instrumentation amplifier. The stage performing the logarithmic conversion also requires two well-matched npn transistors.

The input signal first passes through a high-impedance unity-gain buffer U1A (U2A). Then U1B (U2B) rectifies the input signal at a gain of 0.5, and U1C (U2C) provides a noninverting gain of 2, so that the system gain is still one. U1D (U2D), R6 (R13), and Q1 (Q2) perform the logarithmic conversion of the rectified input signal. The instrumentation amplifier formed by U3A, U3B, U3D scales the difference of the two logarithmic voltages by a gain of 33.6. As a result, the output voltage equals 100 mV/dB. The 1-kΩ potentiometer on the input of U3C calibrates the zero-dB reference level. The following equations are used to derive the relationship between the input voltage ratio, expressed in decibels, and the output voltage.

$$X \text{ dB} = 20 \log \left[ \frac{V_A}{V_B} \right] = 20 \left[ \frac{\ln(V_A) - \ln(V_B)}{\ln(10)} \right]$$

$$X \text{ dB} = 8.686 \left[ \ln(V_A) - \ln(V_B) \right]$$

$$V_{BE(Q1)} = \frac{kT}{q} \ln \left[ \frac{V_A}{R \times I_S} \right] \quad V_{BE(Q2)} = \frac{kT}{q} \ln \left[ \frac{V_B}{R \times I_S} \right]$$

$$\Delta V_{BE} = V_{BE(Q1)} - V_{BE(Q2)} = \frac{kT}{q} \left[ \ln(V_A) - \ln(V_B) \right]$$

$$X \text{ dB} = \frac{8.686}{kT/q} \left[ V_{BE(Q1)} - V_{BE(Q2)} \right] = 336 \left[ V_{BE(Q1)} - V_{BE(Q2)} \right] \text{ at } 25^\circ\text{C}$$

where

$$k = 1.38 \times 10^{-23}, \quad q = 1.602 \times 10^{-19}, \quad \text{and } T \text{ is Kelvin temperature}$$

This gives a resolution of 1 V/dB. Therefore, the gain of the instrumentation amplifier is set at 33.6 to obtain 100 mV/dB.

**APPLICATION INFORMATION**

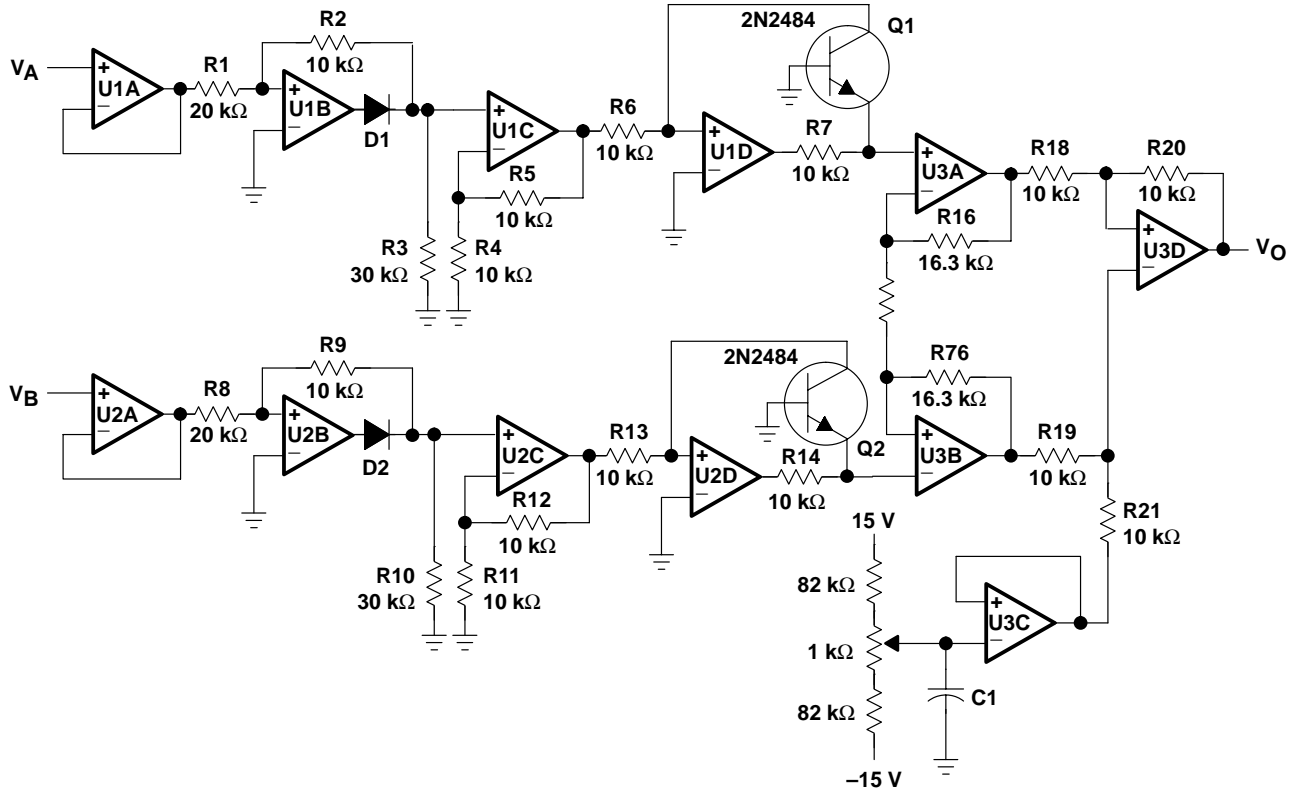

NOTE A: U1A through U3D = TL05xA,  $V_{CC\pm} = \pm 15$  V. D1 and D2 = 1N914.

**Figure 90. Voltage Ratio-to-dB Converter**

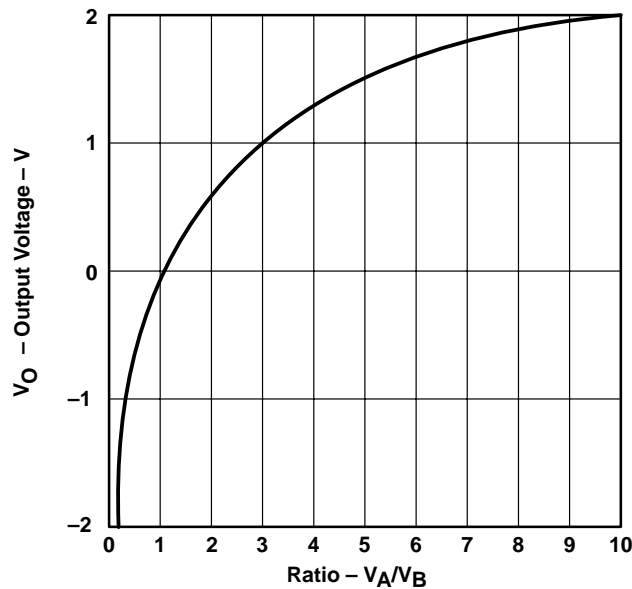

**Figure 91. Output Voltage vs the Ratio of the Input Voltages for Voltage-to-dB Converter**

# TL05x, TL05xA ENHANCED-JFET LOW-OFFSET OPERATIONAL AMPLIFIERS

SLOS178A – FEBRUARY 1997 - REVISED FEBRUARY 2003

## APPLICATION INFORMATION

### macromodel information

Macromodel information provided was derived using Microsim *Parts*™, the model-generation software used with Microsim *PSpice*™. The Boyle macromodel (see Note 6 and subcircuit Figure 92) are generated using the TL05x typical electrical and operating characteristics at  $T_A = 25^\circ\text{C}$ . Using this information, output simulations of the following key parameters can be generated to a tolerance of 20% (in most cases):

- Maximum positive output voltage swing
- Maximum negative output voltage swing
- Slew rate
- Quiescent power dissipation
- Input bias current
- Open-loop voltage amplification
- Unity-gain frequency
- Common-mode rejection ratio
- Phase margin
- DC output resistance
- AC output resistance
- Short-circuit output current limit

NOTE 6: G. R. Boyle, B. M. Cohn, D. O. Pederson, and J. E. Solomon, "Macromodeling of Integrated Circuit Operational Amplifiers", *IEEE Journal of Solid-State Circuits*, SC-9, 353 (1974).

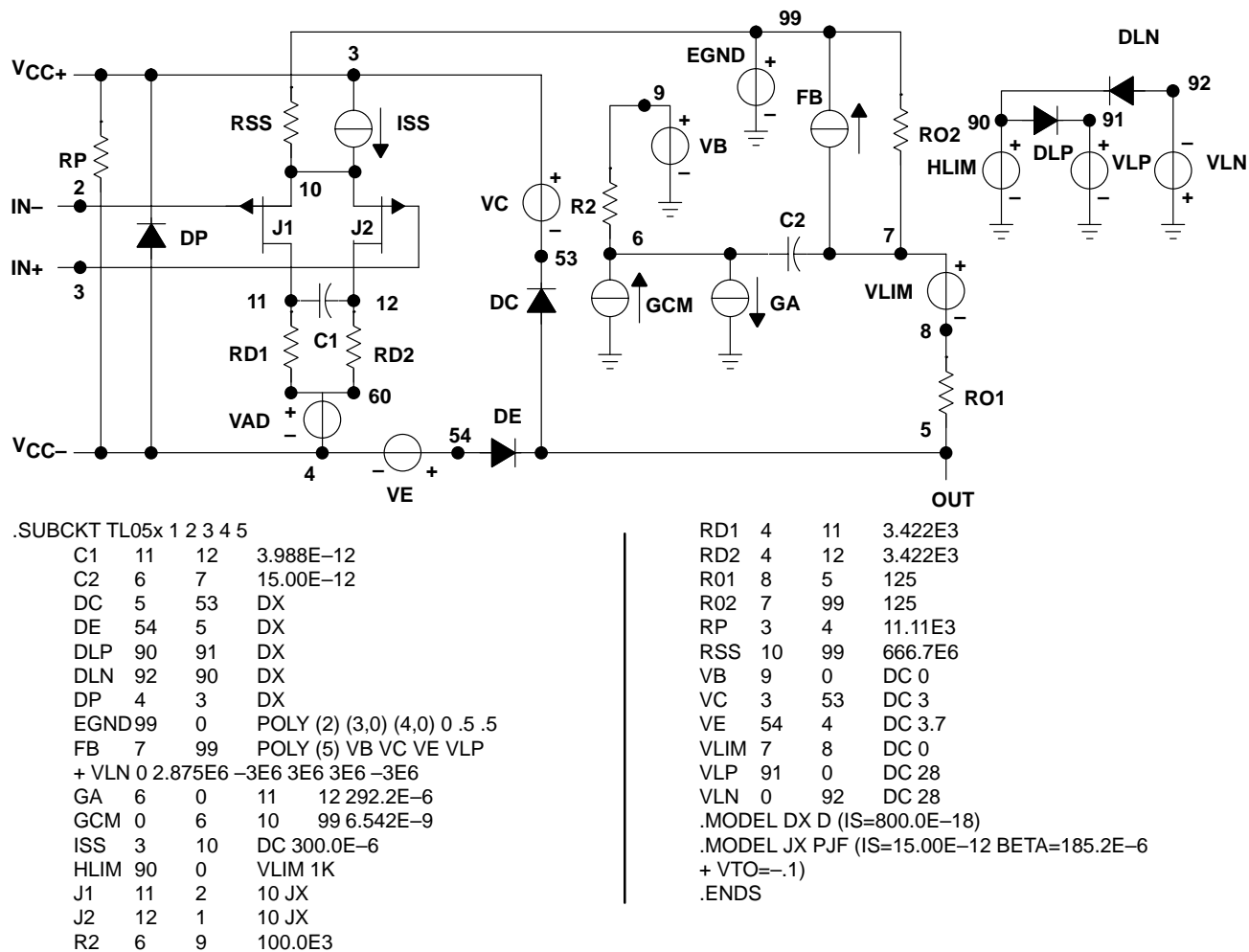

Figure 92. Boyle Macromodel and Subcircuit

*PSpice* and *Parts* are trademarks of MicroSim Corporation.

Macromodels, simulation models, or other models provided by TI, directly or indirectly, are not warranted by TI as fully representing all of the specification and operating characteristics of the semiconductor product to which the model relates.



POST OFFICE BOX 655303 • DALLAS, TEXAS 75265

JG (R-GDIP-T8)

CERAMIC DUAL-IN-LINE



- NOTES: A. All linear dimensions are in inches (millimeters).  
 B. This drawing is subject to change without notice.  
 C. This package can be hermetically sealed with a ceramic lid using glass frit.  
 D. Index point is provided on cap for terminal identification.  
 E. Falls within MIL STD 1835 GDIP1-T8

J (R-GDIP-T\*\*)

CERAMIC DUAL-IN-LINE

14 LEADS SHOWN

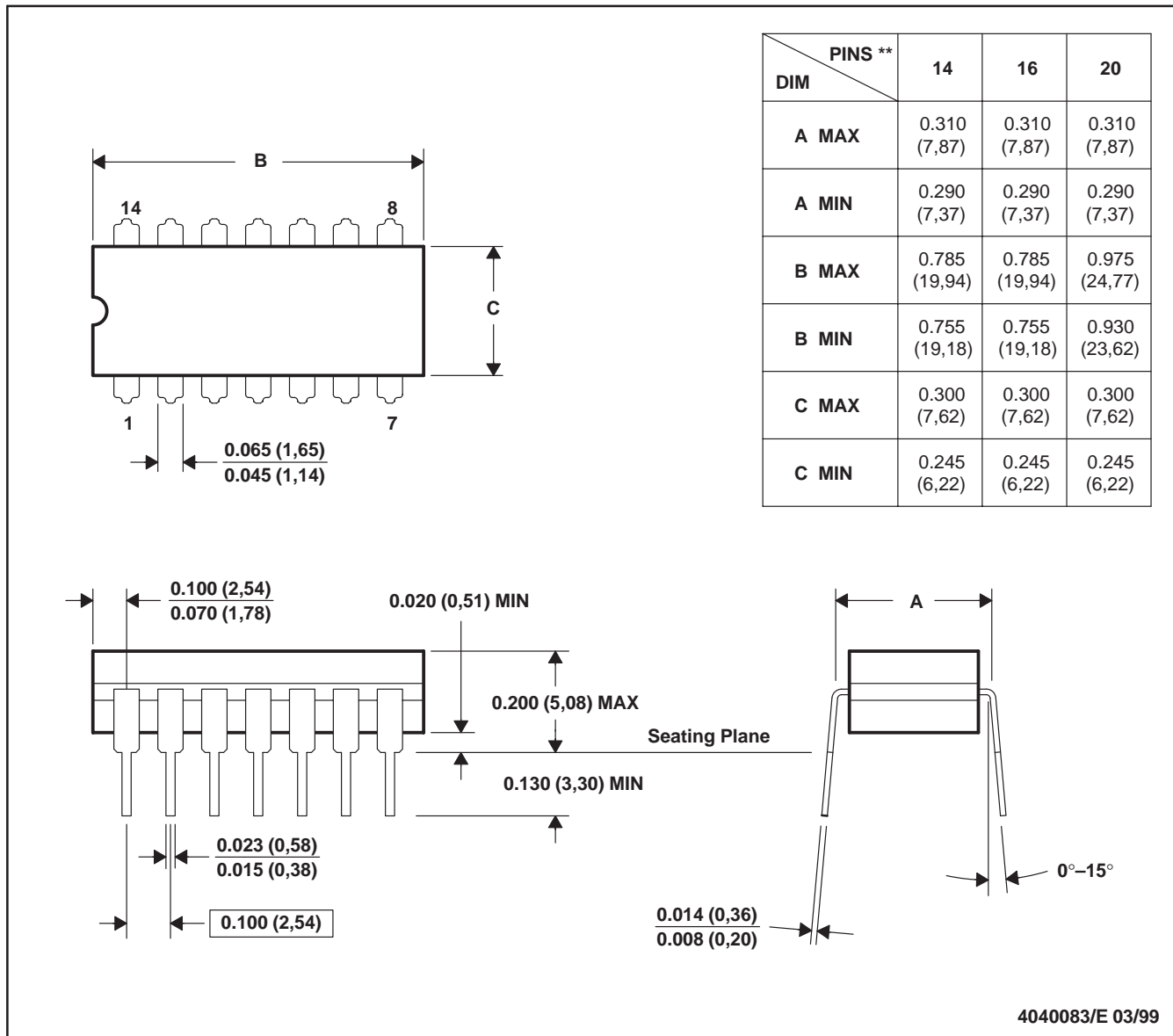

- NOTES: A. All linear dimensions are in inches (millimeters).  
 B. This drawing is subject to change without notice.  
 C. This package is hermetically sealed with a ceramic lid using glass frit.  
 D. Index point is provided on cap for terminal identification.  
 E. Falls within MIL STD 1835 GDIP1-T14, GDIP1-T16, and GDIP1-T20

FK (S-CQCC-N\*\*)

LEADLESS CERAMIC CHIP CARRIER

28 TERMINAL SHOWN

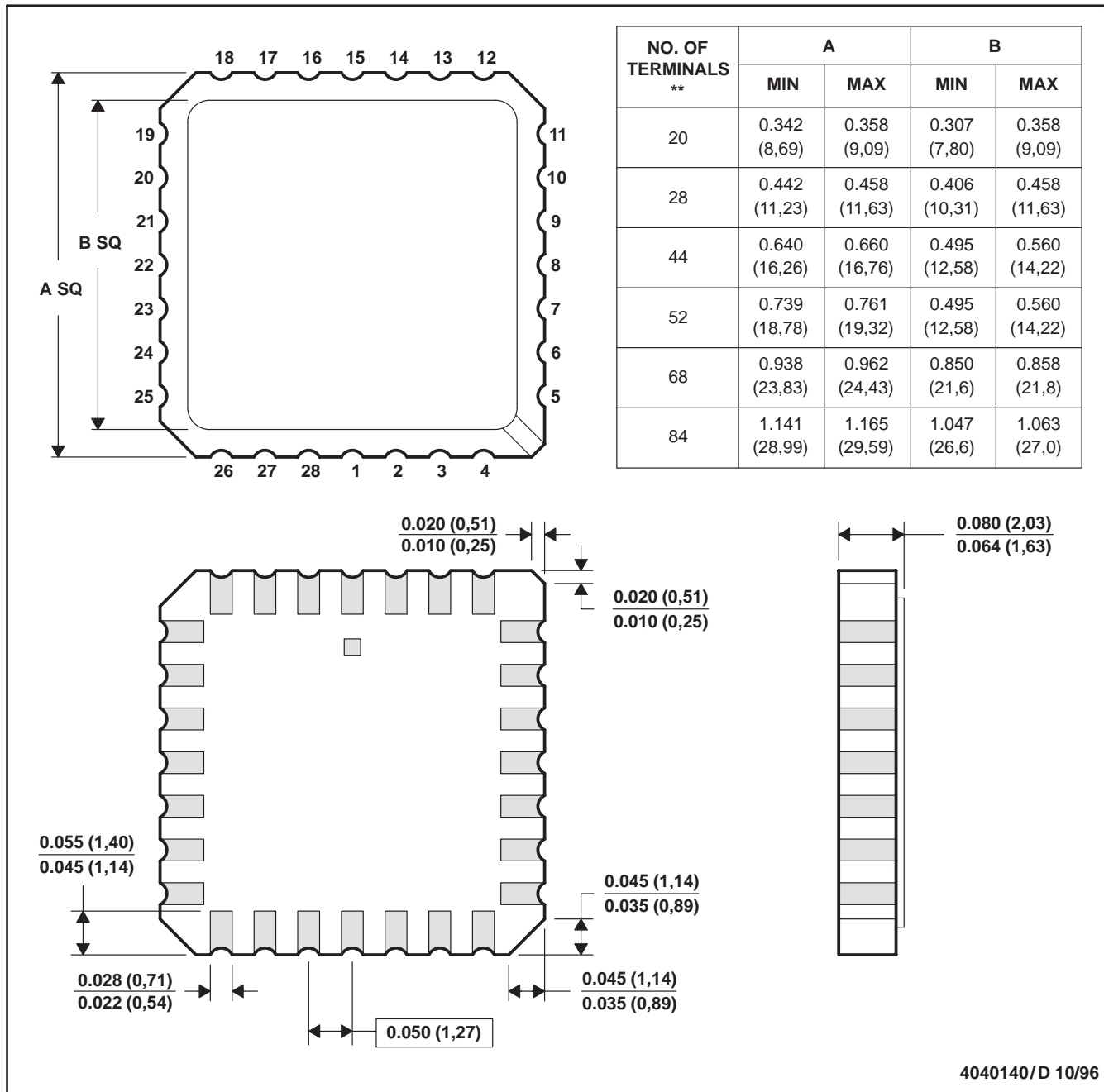

- NOTES:
- A. All linear dimensions are in inches (millimeters).
  - B. This drawing is subject to change without notice.
  - C. This package can be hermetically sealed with a metal lid.
  - D. The terminals are gold plated.
  - E. Falls within JEDEC MS-004

P (R-PDIP-T8)

PLASTIC DUAL-IN-LINE

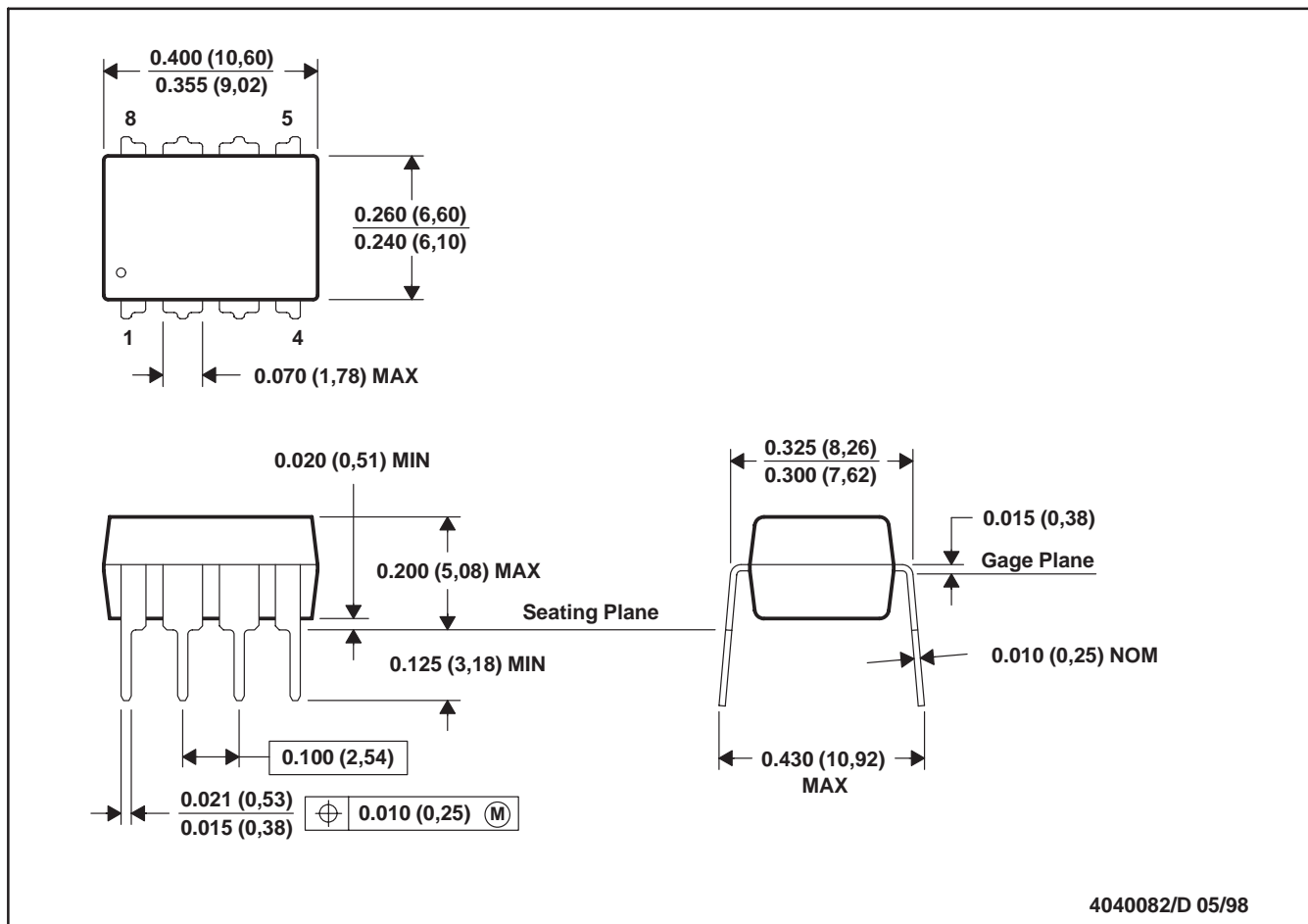

- NOTES: A. All linear dimensions are in inches (millimeters).  
 B. This drawing is subject to change without notice.  
 C. Falls within JEDEC MS-001

For the latest package information, go to [http://www.ti.com/sc/docs/package/pkg\\_info.htm](http://www.ti.com/sc/docs/package/pkg_info.htm)

N (R-PDIP-T\*\*)

PLASTIC DUAL-IN-LINE PACKAGE

16 PINS SHOWN

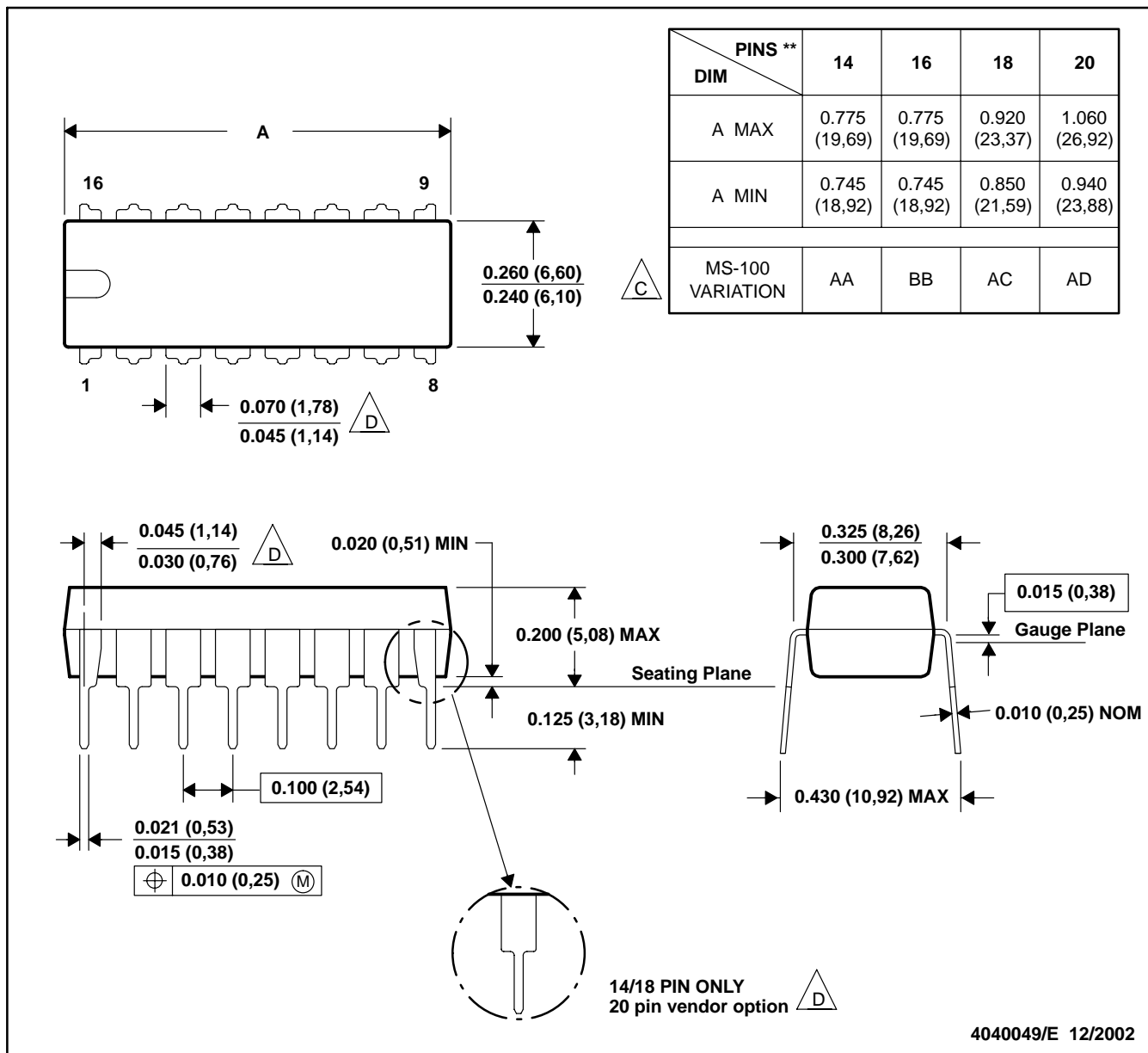

- NOTES: A. All linear dimensions are in inches (millimeters).  
 B. This drawing is subject to change without notice.  
 C Falls within JEDEC MS-001, except 18 and 20 pin minimum body length (Dim A).  
 D The 20 pin end lead shoulder width is a vendor option, either half or full width.

D (R-PDSO-G\*\*)

PLASTIC SMALL-OUTLINE PACKAGE

8 PINS SHOWN

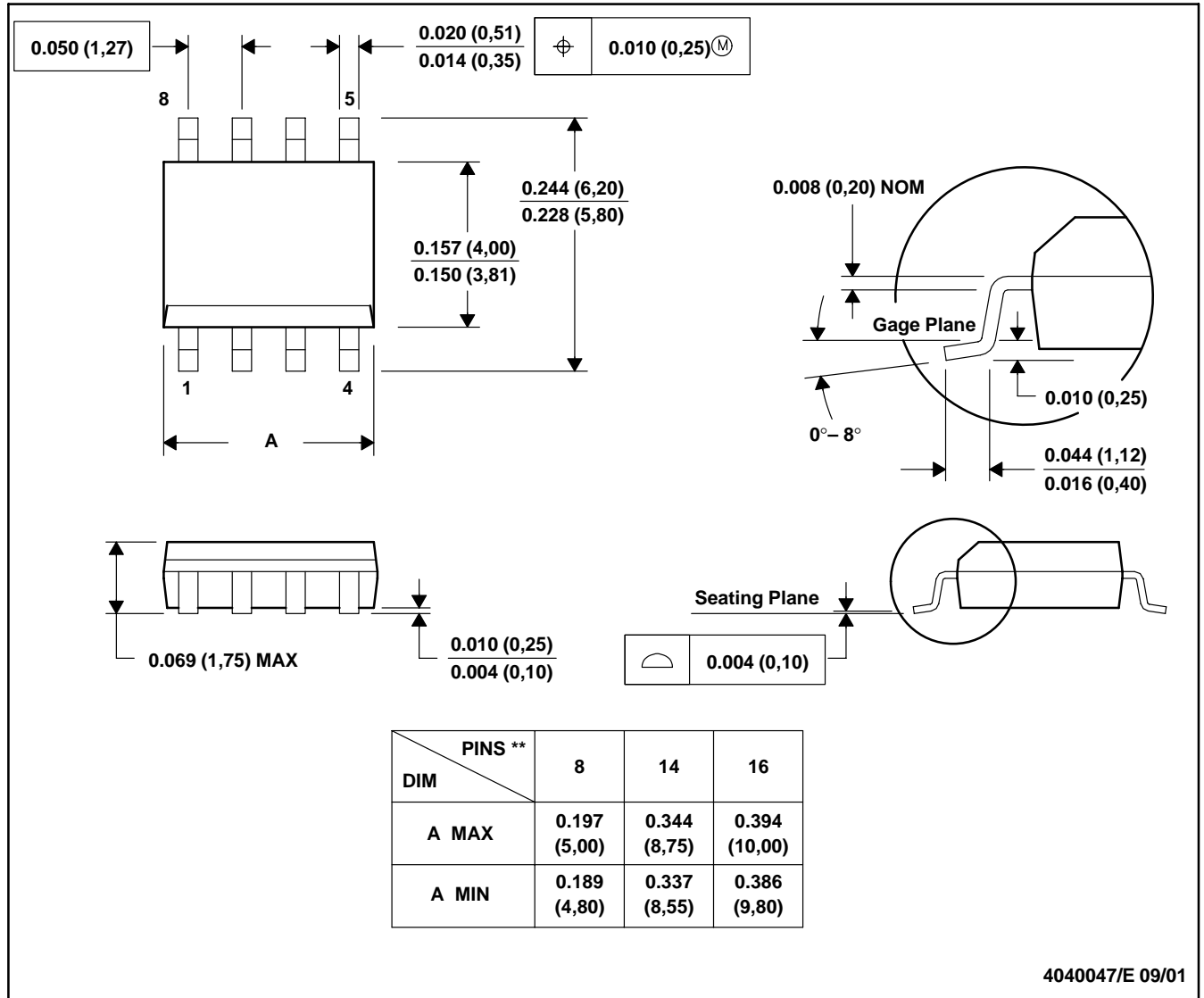

- NOTES: A. All linear dimensions are in inches (millimeters).  
 B. This drawing is subject to change without notice.  
 C. Body dimensions do not include mold flash or protrusion, not to exceed 0.006 (0,15).  
 D. Falls within JEDEC MS-012

PS (R-PDSO-G8)

PLASTIC SMALL-OUTLINE PACKAGE

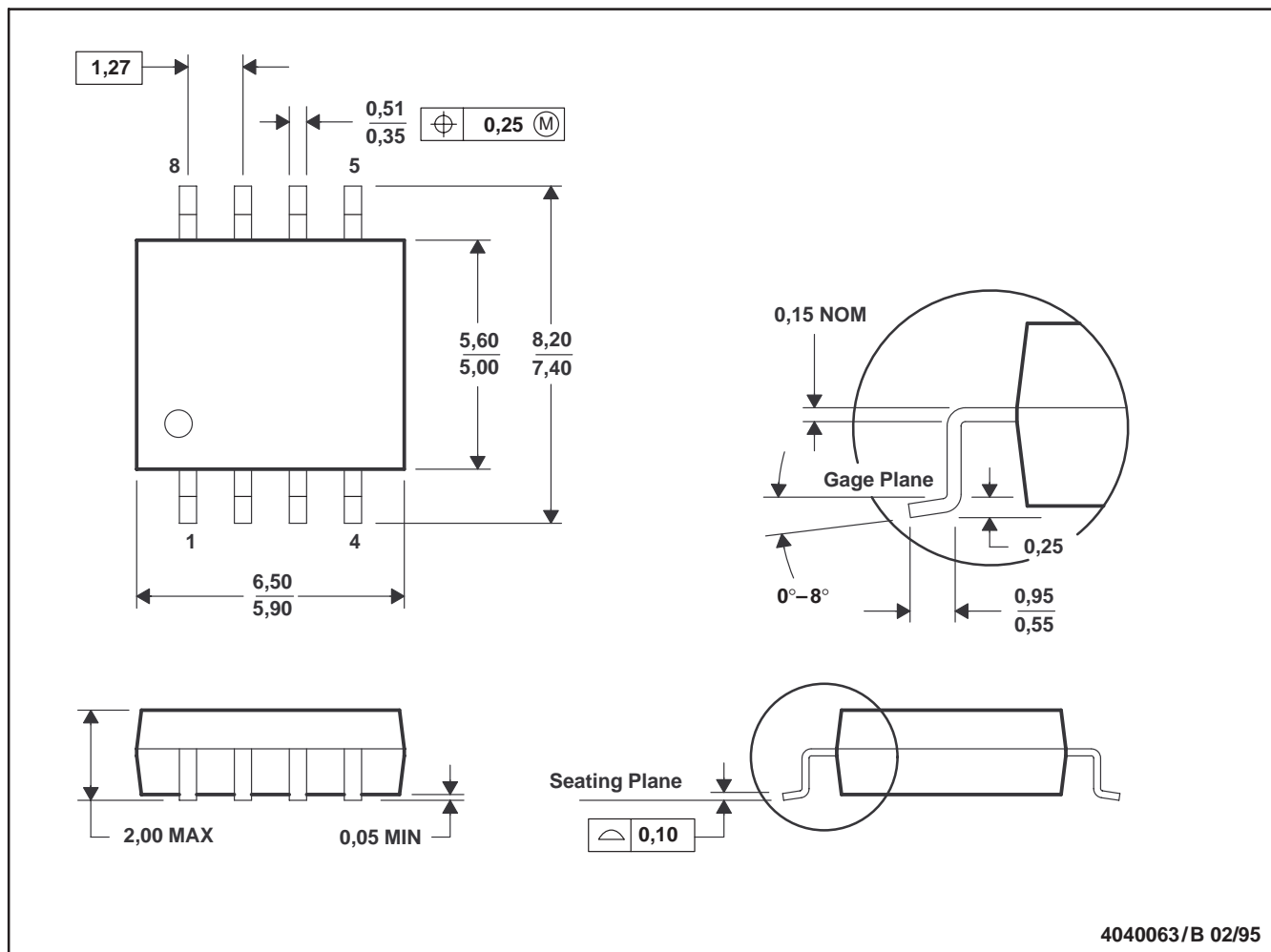

- NOTES: A. All linear dimensions are in millimeters.  
 B. This drawing is subject to change without notice.  
 C. Body dimensions do not include mold flash or protrusion, not to exceed 0,15.

NS (R-PDSO-G\*\*)

PLASTIC SMALL-OUTLINE PACKAGE

14 PINS SHOWN

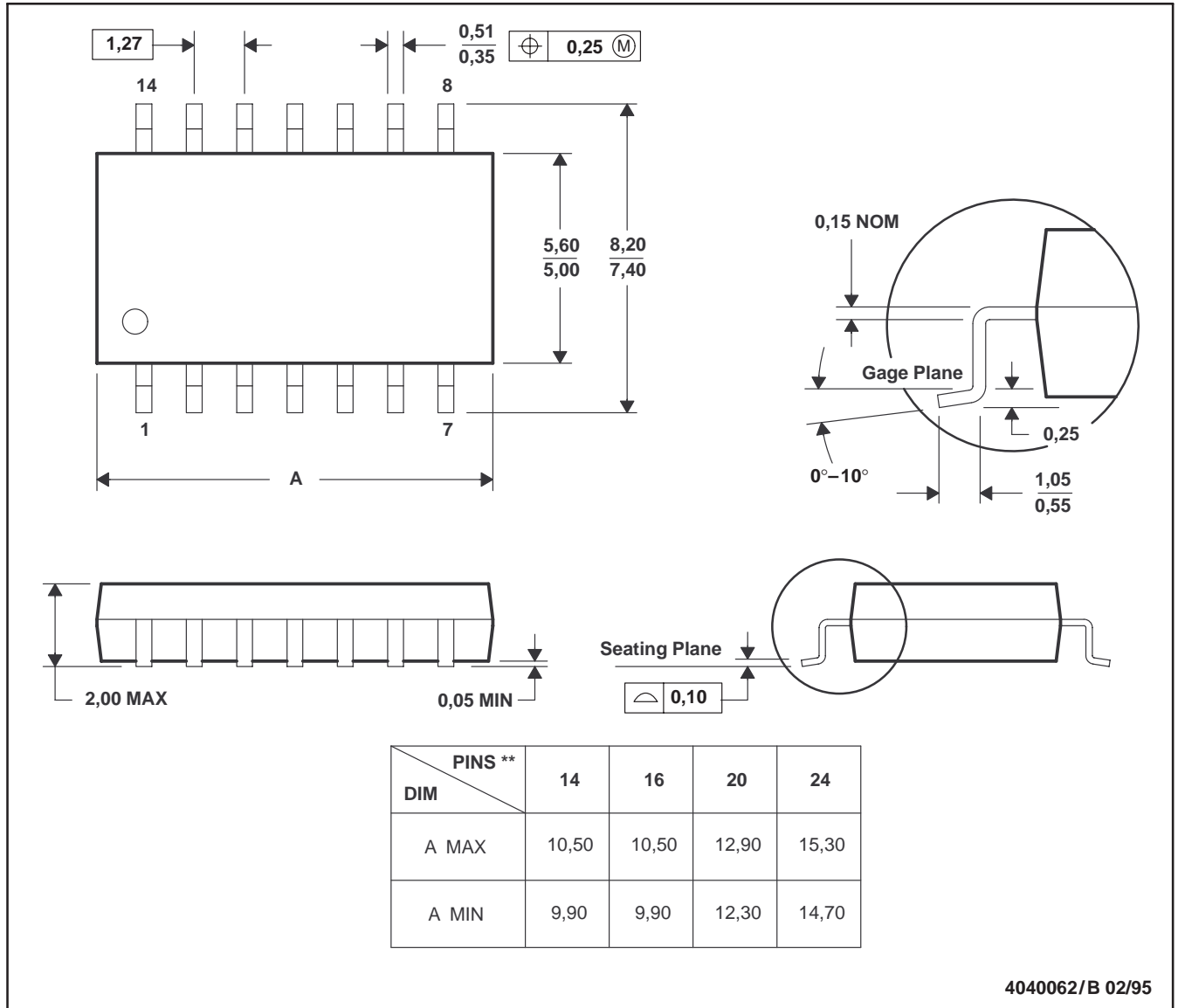

- NOTES: A. All linear dimensions are in millimeters.  
 B. This drawing is subject to change without notice.  
 C. Body dimensions do not include mold flash or protrusion, not to exceed 0,15.

## IMPORTANT NOTICE

Texas Instruments Incorporated and its subsidiaries (TI) reserve the right to make corrections, modifications, enhancements, improvements, and other changes to its products and services at any time and to discontinue any product or service without notice. Customers should obtain the latest relevant information before placing orders and should verify that such information is current and complete. All products are sold subject to TI's terms and conditions of sale supplied at the time of order acknowledgment.

TI warrants performance of its hardware products to the specifications applicable at the time of sale in accordance with TI's standard warranty. Testing and other quality control techniques are used to the extent TI deems necessary to support this warranty. Except where mandated by government requirements, testing of all parameters of each product is not necessarily performed.

TI assumes no liability for applications assistance or customer product design. Customers are responsible for their products and applications using TI components. To minimize the risks associated with customer products and applications, customers should provide adequate design and operating safeguards.

TI does not warrant or represent that any license, either express or implied, is granted under any TI patent right, copyright, mask work right, or other TI intellectual property right relating to any combination, machine, or process in which TI products or services are used. Information published by TI regarding third-party products or services does not constitute a license from TI to use such products or services or a warranty or endorsement thereof. Use of such information may require a license from a third party under the patents or other intellectual property of the third party, or a license from TI under the patents or other intellectual property of TI.

Reproduction of information in TI data books or data sheets is permissible only if reproduction is without alteration and is accompanied by all associated warranties, conditions, limitations, and notices. Reproduction of this information with alteration is an unfair and deceptive business practice. TI is not responsible or liable for such altered documentation.

Resale of TI products or services with statements different from or beyond the parameters stated by TI for that product or service voids all express and any implied warranties for the associated TI product or service and is an unfair and deceptive business practice. TI is not responsible or liable for any such statements.

### Mailing Address:

Texas Instruments  
Post Office Box 655303  
Dallas, Texas 75265