

## LOW-NOISE JFET-INPUT OPERATIONAL AMPLIFIER

 Check for Samples: [TL072-EP](#), [TL074-EP](#)

### FEATURES

- Low Power Consumption
- Wide Common-Mode and Differential Voltage Ranges
- Low Input Bias and Offset Currents
- Output Short-Circuit Protection
- Low Total Harmonic Distortion: **0.003% Typ**
- Low Noise  
 $V_n = 18 \text{ nV}/\sqrt{\text{Hz}}$  Typ at  $f = 1 \text{ kHz}$
- High Input Impedance: JFET Input Stage
- Internal Frequency Compensation
- Latch-Up-Free Operation
- High Slew Rate:  $13 \text{ V}/\mu\text{s}$  Typ
- Common-Mode Input Voltage Range Includes  $V_{CC+}$

### SUPPORTS DEFENSE, AEROSPACE, AND MEDICAL APPLICATIONS

- Controlled Baseline
- One Assembly and Test Site
- One Fabrication Site
- Available in Extended ( $-40^\circ\text{C}$  to  $125^\circ\text{C}$ ) or Military ( $-55^\circ\text{C}$  to  $125^\circ\text{C}$ ) Temperature Range
- Extended Product Life Cycle
- Extended Product-Change Notification
- Product Traceability

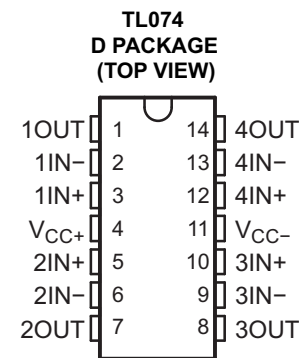
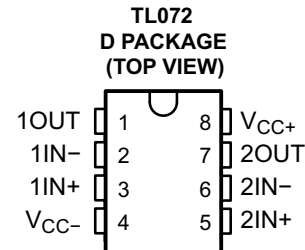

### DESCRIPTION/ORDERING INFORMATION

The JFET-input operational amplifiers in the TL07x is similar to the TL08x series, with low input bias and offset currents and fast slew rate. The low harmonic distortion and low noise make the TL07x ideally suited for high-fidelity and audio preamplifier applications. Each amplifier features JFET inputs (for high input impedance) coupled with bipolar output stages integrated on a single monolithic chip.

The TL07x is characterized for operation over the extended temperature range of  $-40^\circ\text{C}$  to  $125^\circ\text{C}$  or military temperature range of  $-55^\circ\text{C}$  to  $125^\circ\text{C}$ .

### ORDERING INFORMATION<sup>(1)</sup>

$T_A$	$V_{IO\text{maX}}$ AT $25^\circ\text{C}$	PACKAGE		ORDERABLE PART NUMBER	TOP-SIDE MARKING	VID NUMBER
$-40^\circ\text{C}$ to $125^\circ\text{C}$	6 mV	SOIC – D	Reel of 2500	TL072QDREP	TL072Q	V62/12604-01XE
				TL074QDREP	TL074Q	V62/11621-01XE
$-55^\circ\text{C}$ to $125^\circ\text{C}$	6 mV	SOIC – D	Reel of 2500	TL074MDREP	TL074M	V62/11621-02XE
			Tube of 75	TL074MDEP	TL074M	V62/11621-02XE-T

(1) For the most current package and ordering information, see the Package Option Addendum at the end of this document, or see the TI website at [www.ti.com](http://www.ti.com).



Please be aware that an important notice concerning availability, standard warranty, and use in critical applications of Texas Instruments semiconductor products and disclaimers thereto appears at the end of this data sheet.

**TL072 and TL074 SYMBOL (EACH AMPLIFIER)**

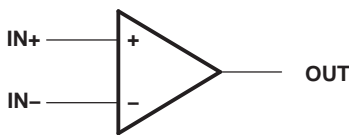

**SCHEMATIC (EACH AMPLIFIER)**

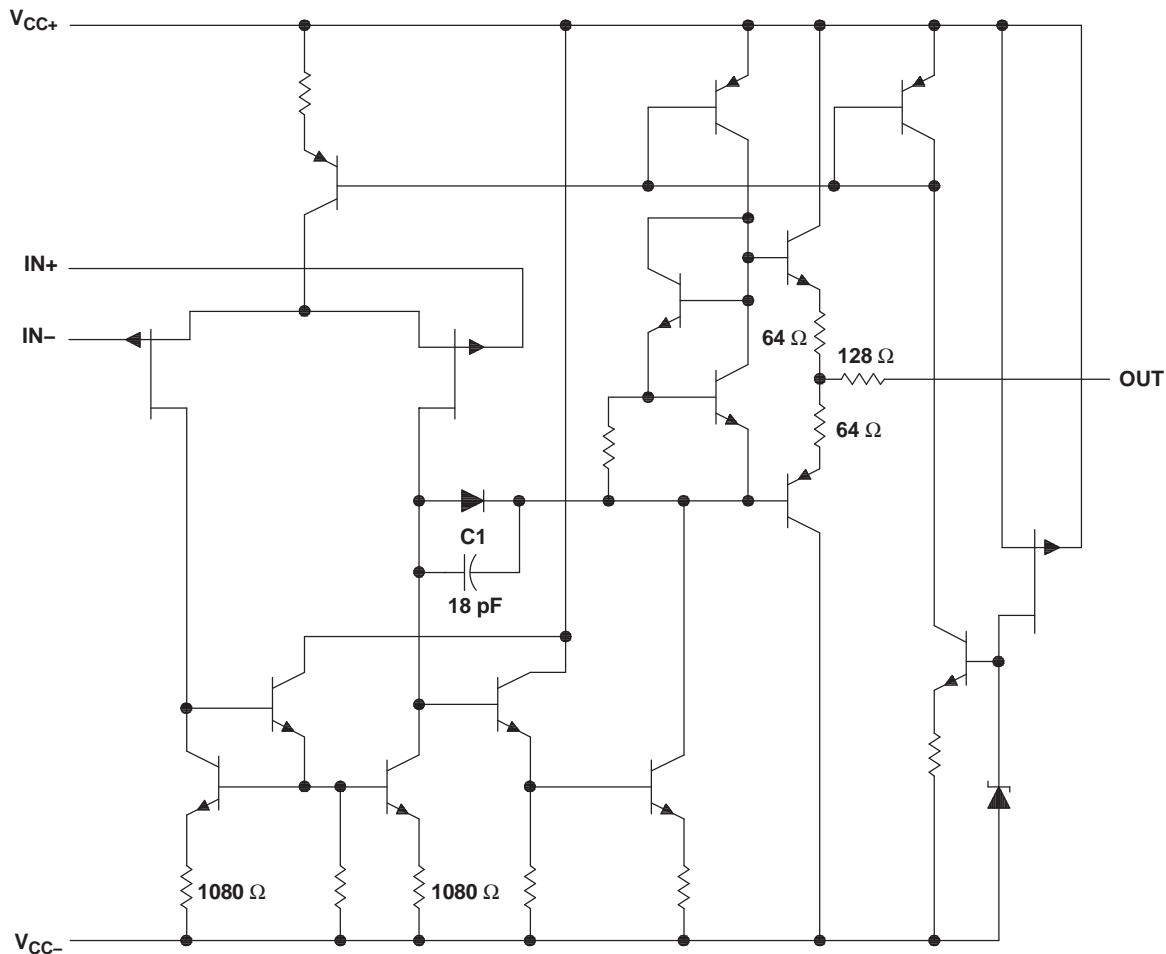

All component values shown are nominal.

COMPONENT COUNT <sup>(1)</sup>		
COMPONENT TYPE	TL072	TL074
Resistors	22	44
Transistors	28	56
JFET	4	6
Diodes	2	4
Capacitors	2	4
epi-FET	2	4

(1) Includes bias and trim circuitry

**ABSOLUTE MAXIMUM RATINGS<sup>(1)</sup>**

over operating free-air temperature range (unless otherwise noted)

		MIN	MAX	UNIT
V <sub>CC+</sub>	Supply voltage <sup>(2)</sup>		18	V
V <sub>CC-</sub>			18	
V <sub>ID</sub>	Differential input voltage <sup>(3)</sup>		±30	V
V <sub>I</sub>	Input voltage <sup>(2) (4)</sup>		±15	V
	Duration of output short circuit <sup>(5)</sup>		Unlimited	
θ <sub>JA</sub>	Thermal resistance, junction-to-ambient <sup>(6) (7)</sup>	TL072	97.5	°C/W
		TL074	86	
θ <sub>JC</sub>	Thermal resistance, junction-to-case <sup>(7)</sup>	TL072	38.3	°C/W
		TL074	51.5	
T <sub>J</sub>	Operating virtual junction temperature		150	°C
T <sub>stg</sub>	Storage temperature range	-65	150	°C

- (1) Stresses beyond those listed under “absolute maximum ratings” may cause permanent damage to the device. These are stress ratings only, and functional operation of the device at these or any other conditions beyond those indicated under “recommended operating conditions” is not implied. Exposure to absolute-maximum-rated conditions for extended periods may affect device reliability.
- (2) All voltage values, except differential voltages, are with respect to the midpoint between V<sub>CC+</sub> and V<sub>CC-</sub>.
- (3) Differential voltages are at IN+, with respect to IN-.
- (4) The magnitude of the input voltage must never exceed the magnitude of the supply voltage or 15 V, whichever is less.
- (5) The output may be shorted to ground or to either supply. Temperature and/or supply voltages must be limited to ensure that the dissipation rating is not exceeded.
- (6) Operating at the absolute maximum T<sub>J</sub> of 150°C can affect reliability.
- (7) The package thermal impedance is calculated in accordance with JESD 51-7.

### ELECTRICAL CHARACTERISTICS

V<sub>CC±</sub> = ±15 V (unless otherwise noted)

PARAMETER	TEST CONDITIONS <sup>(1)</sup>	T <sub>A</sub> <sup>(2)</sup>	TL072			TL074			UNIT	
			MIN	TYP	MAX	MIN	TYP	MAX		
V <sub>IO</sub>	Input offset voltage	V <sub>O</sub> = 0, R <sub>S</sub> = 50 Ω	25°C		3	6	3		6	mV
			Full range				8		8	
α <sub>VIO</sub>	Temperature coefficient of input offset voltage	V <sub>O</sub> = 0, R <sub>S</sub> = 50 Ω	Full range		18		18		μV/°C	
I <sub>IO</sub>	Input offset current	V <sub>O</sub> = 0	25°C		5	100	5		100	pA
			125°C				2		2	nA
I <sub>IB</sub>	Input bias current	V <sub>O</sub> = 0	25°C		65	200	65		200	pA
			125°C				20		20	nA
V <sub>ICR</sub>	Common-mode input voltage range		25°C		±11 –12 to 15		±11 –12 to 15		V	
V <sub>OM</sub>	Maximum peak output voltage swing	R <sub>L</sub> = 10 kΩ	25°C		±12	±13.5	±12		±13.5	V
		R <sub>L</sub> ≥ 10 kΩ	Full range		±12		±12			
		R <sub>L</sub> ≥ 2 kΩ	Full range		±10		±10			
A <sub>VD</sub>	Large-signal differential voltage amplification	V <sub>O</sub> = ±10 V, R <sub>L</sub> ≥ 2 kΩ	25°C		35	200	35		200	V/mV
			Full range		15		15			
B <sub>1</sub>	Unity-gain bandwidth		25°C		3		3		MHz	
r <sub>i</sub>	Input resistance		25°C		10 <sup>12</sup>		10 <sup>12</sup>		Ω	
CMRR	Common-mode rejection ratio	V <sub>IC</sub> = V <sub>ICRmin</sub> , V <sub>O</sub> = 0, R <sub>S</sub> = 50 Ω	25°C		80	86	80		86	dB
k <sub>SVR</sub>	Supply-voltage rejection ratio (ΔV <sub>CC±</sub> /ΔV <sub>IO</sub> )	V <sub>CC</sub> = ±9 V to ±15 V, V <sub>O</sub> = 0, R <sub>S</sub> = 50 Ω	25°C		80	86	80		86	dB
I <sub>CC</sub>	Supply current (each amplifier)	V <sub>O</sub> = 0, No load	25°C		1.4	2.5	1.4		2.5	mA
V <sub>O1</sub> /V <sub>O2</sub>	Crosstalk attenuation	A <sub>VD</sub> = 100	25°C		120		120		dB	

- Input bias currents of an FET-input operational amplifier are normal junction reverse currents, which are temperature sensitive, as shown in Figure 3. Pulse techniques must be used that will maintain the junction temperature as close to the ambient temperature as possible.
- All characteristics are measured under open-loop conditions with zero common-mode voltage, unless otherwise specified. Full range is T<sub>A</sub> = -40°C to 125°C for TL07xQ and T<sub>A</sub> = -55°C to 125°C for TL07xM.

### OPERATING CHARACTERISTICS

V<sub>CC±</sub> = ±15 V, T<sub>A</sub> = 25°C

PARAMETER	TEST CONDITIONS	TL072			TL074			UNIT
		MIN	TYP	MAX	MIN	TYP	MAX	
SR	Slew rate at unity gain	V <sub>I</sub> = 10 V, C <sub>L</sub> = 100 pF, R <sub>L</sub> = 2 kΩ, See Figure 1	8	13		8	13	V/μs
t <sub>r</sub>	Rise-time overshoot factor	V <sub>I</sub> = 20 V, C <sub>L</sub> = 100 pF, R <sub>L</sub> = 2 kΩ, See Figure 1	0.1			0.1		μs
			20			20		%
V <sub>n</sub>	Equivalent input noise voltage	R <sub>S</sub> = 20 Ω	f = 1 kHz		18	18		nV/√Hz
			f = 10 Hz to 10 kHz		4	4		μV
I <sub>n</sub>	Equivalent input noise current	R <sub>S</sub> = 20 Ω, f = 1 kHz	0.01		0.01		pA/√Hz	
THD	Total harmonic distortion	V <sub>I rms</sub> = 6 V, R <sub>L</sub> ≥ 2 kΩ, f = 1 kHz, A <sub>VD</sub> = 1, R <sub>S</sub> ≤ 1 kΩ,	0.003		0.003		%	

PARAMETER MEASUREMENT INFORMATION

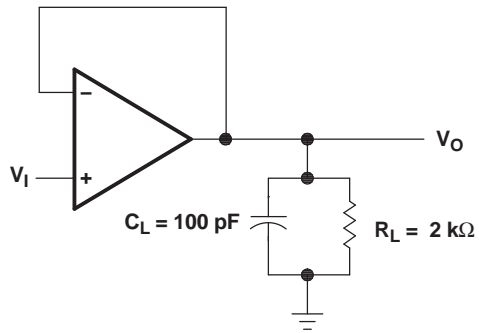

Figure 1. Unity-Gain Amplifier

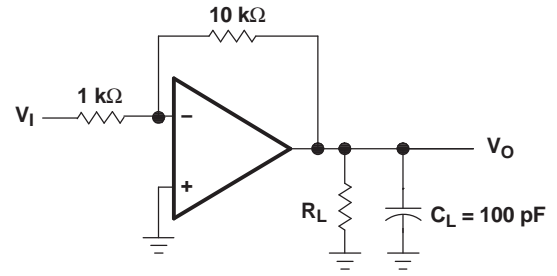
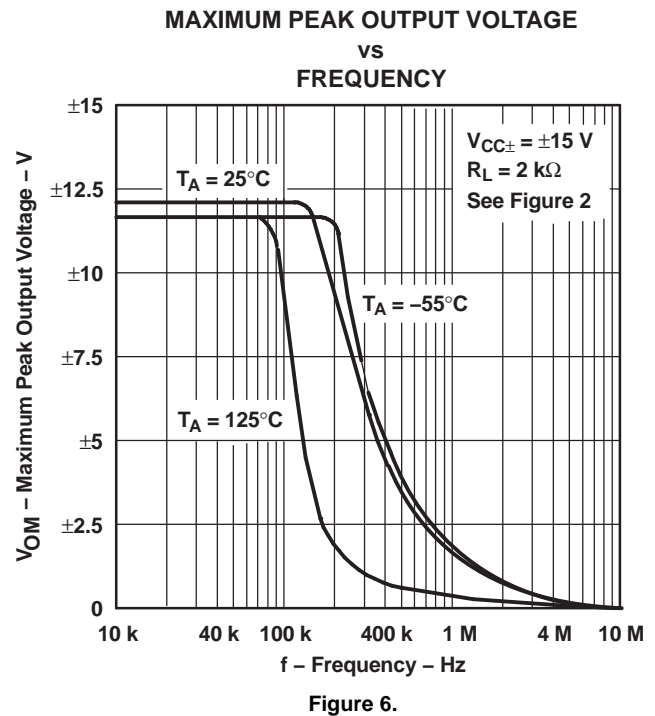
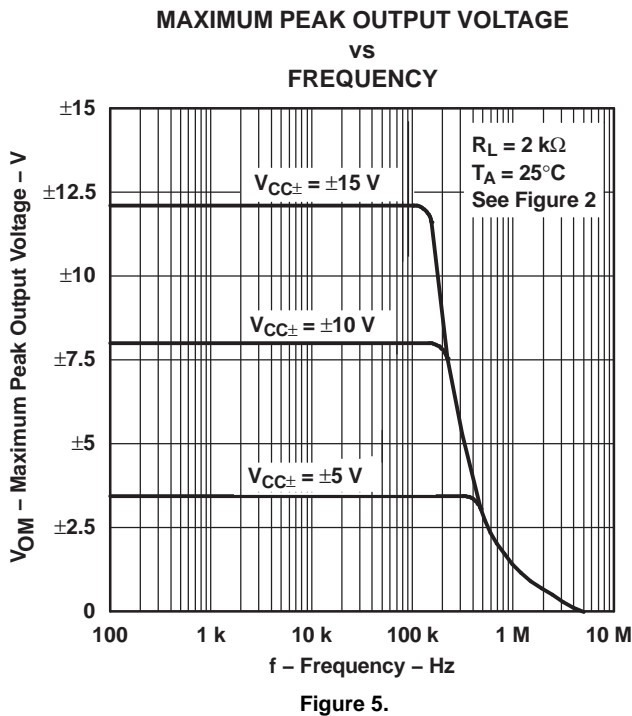
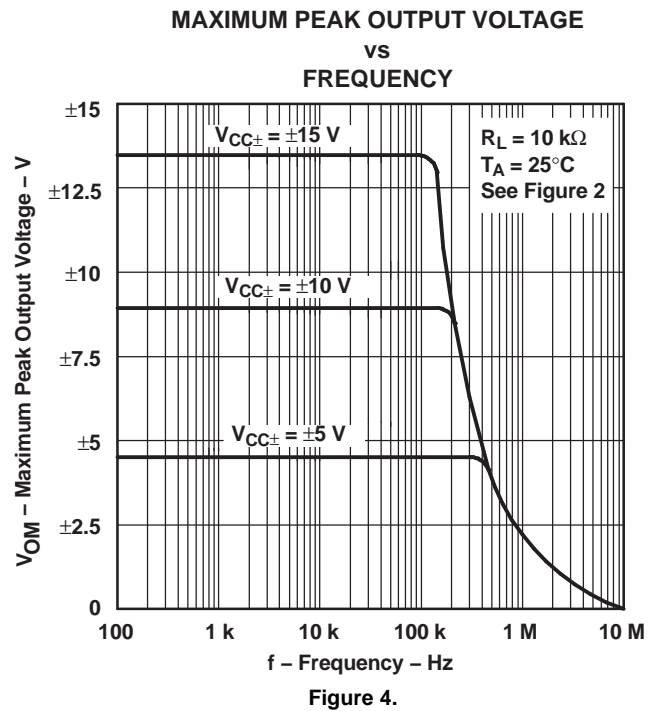
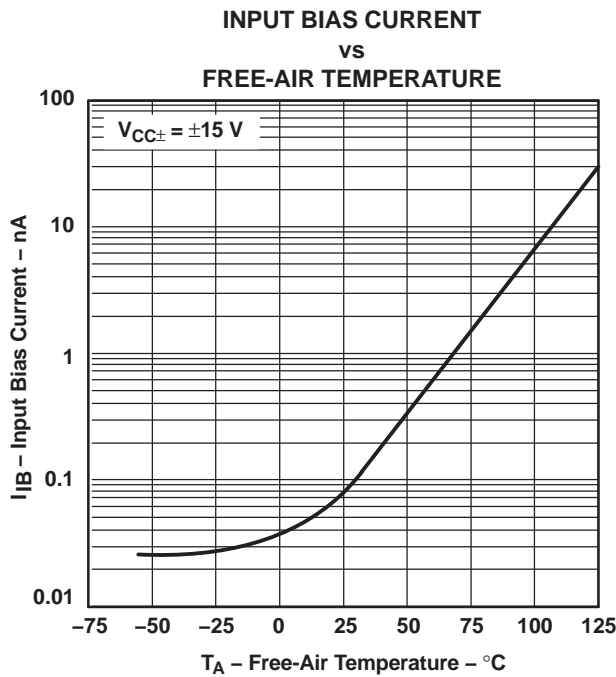

Figure 2. Gain-of-10 Inverting Amplifier

### TYPICAL CHARACTERISTICS

Data at high and low temperatures are applicable only within the rated operating free-air temperature ranges of the various devices.



**TYPICAL CHARACTERISTICS (continued)**

Data at high and low temperatures are applicable only within the rated operating free-air temperature ranges of the various devices.

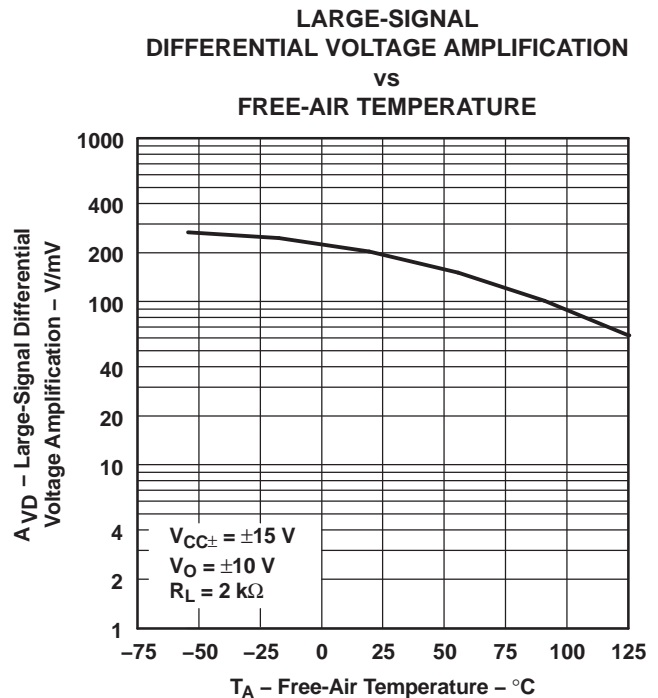
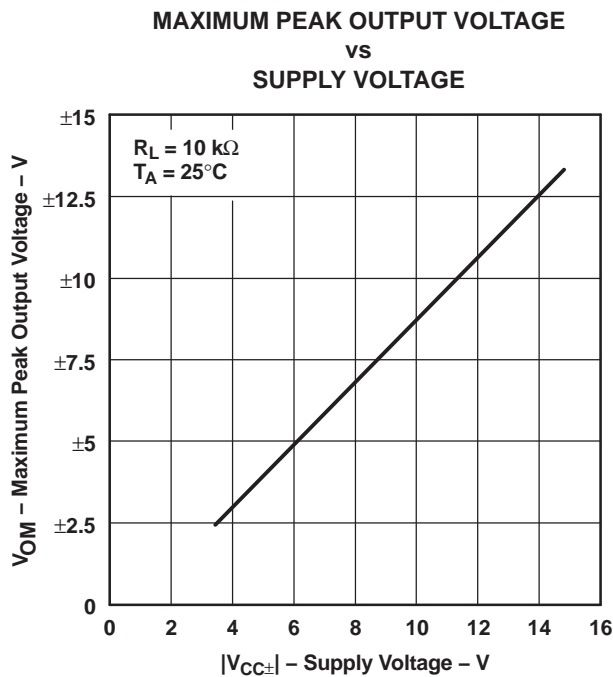
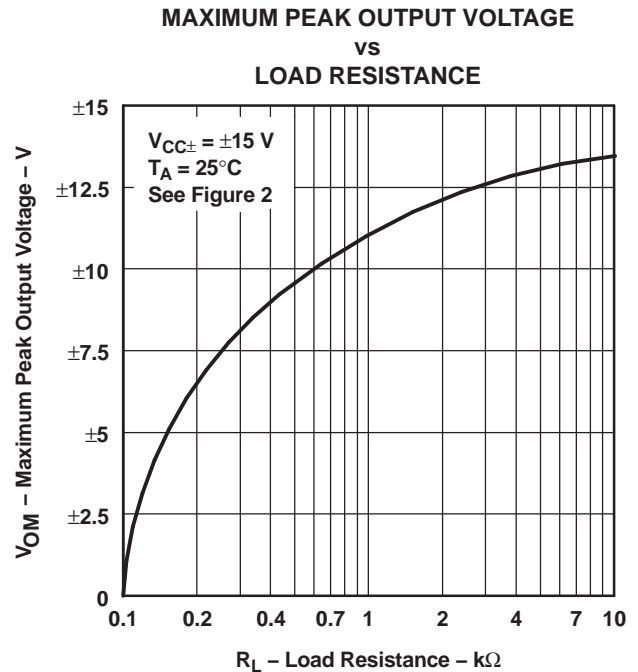
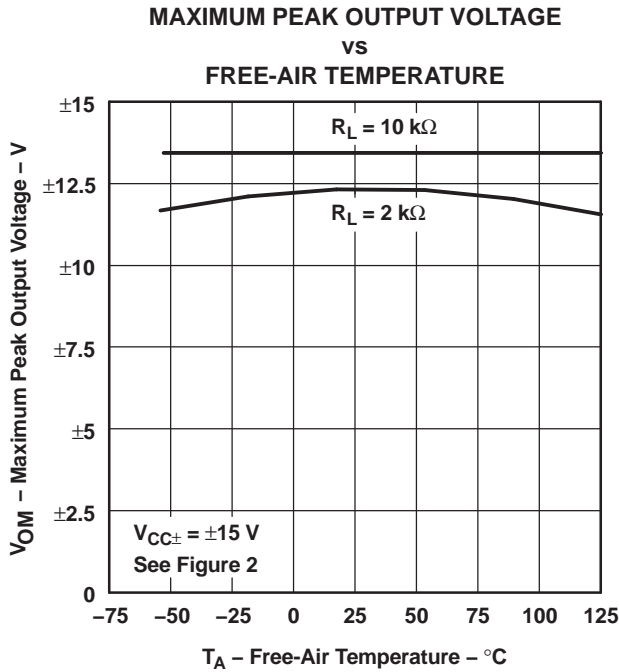

**TYPICAL CHARACTERISTICS (continued)**

Data at high and low temperatures are applicable only within the rated operating free-air temperature ranges of the various devices.

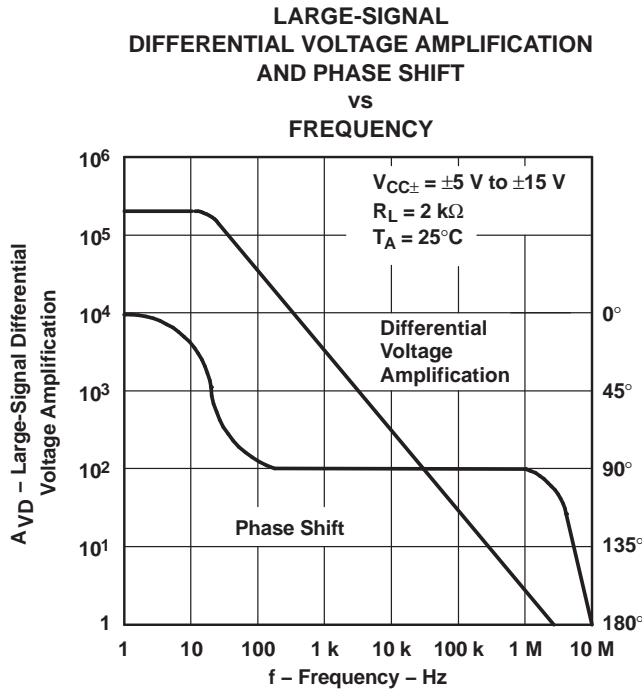

Figure 11.

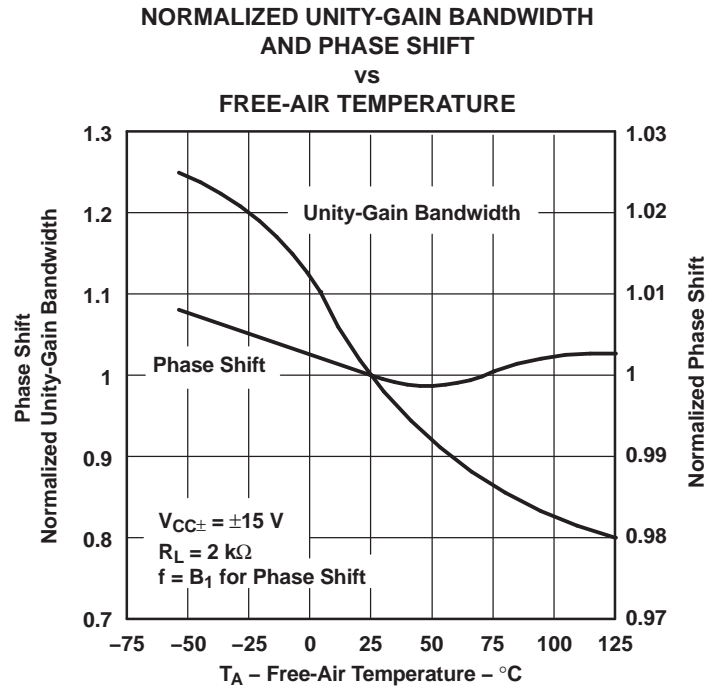

Figure 12.

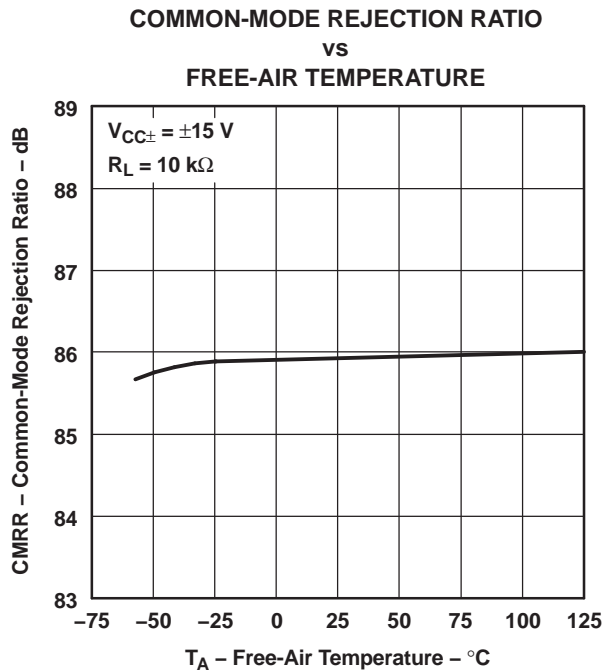

Figure 13.

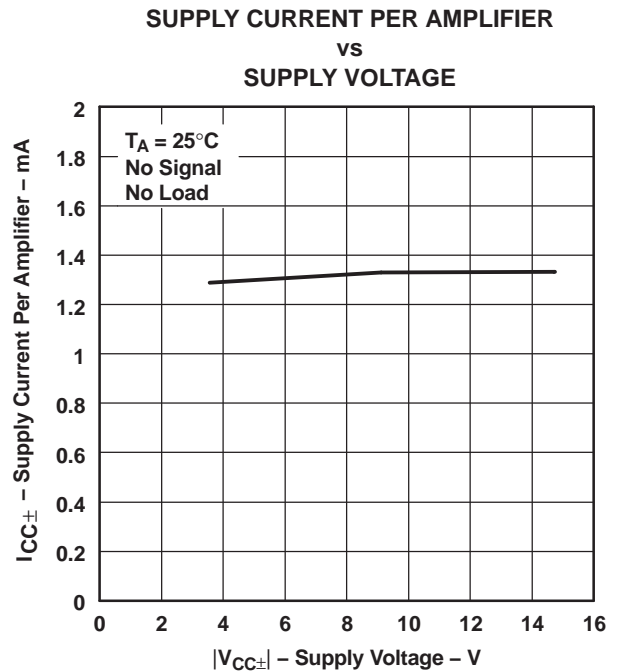

Figure 14.



**TYPICAL CHARACTERISTICS (continued)**

Data at high and low temperatures are applicable only within the rated operating free-air temperature ranges of the various devices.

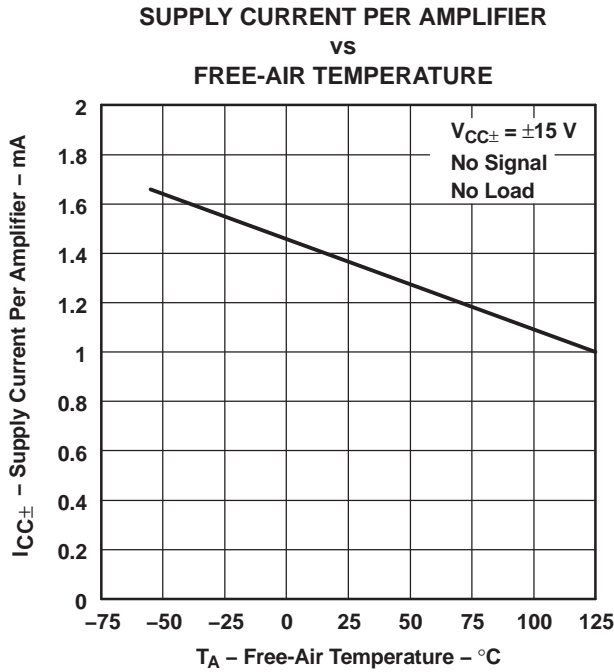

Figure 15.

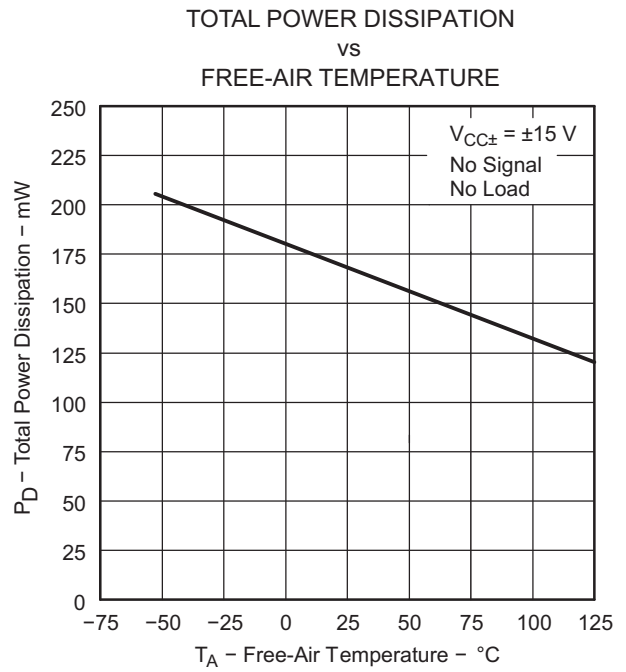

Figure 16.

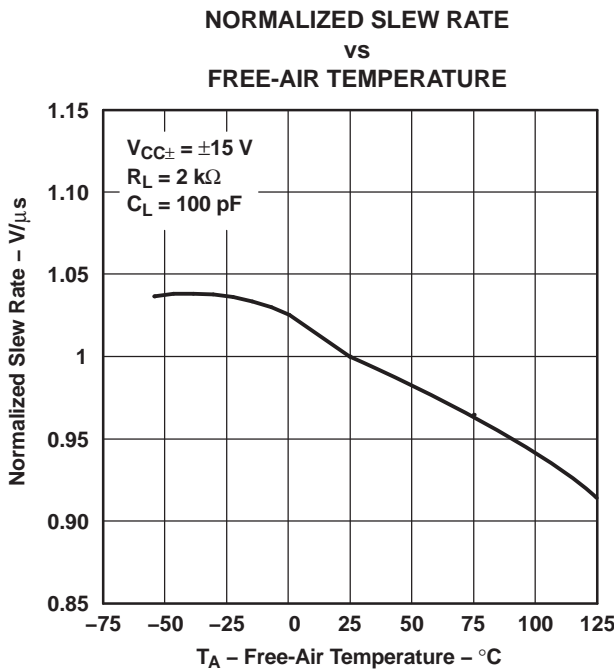

Figure 17.

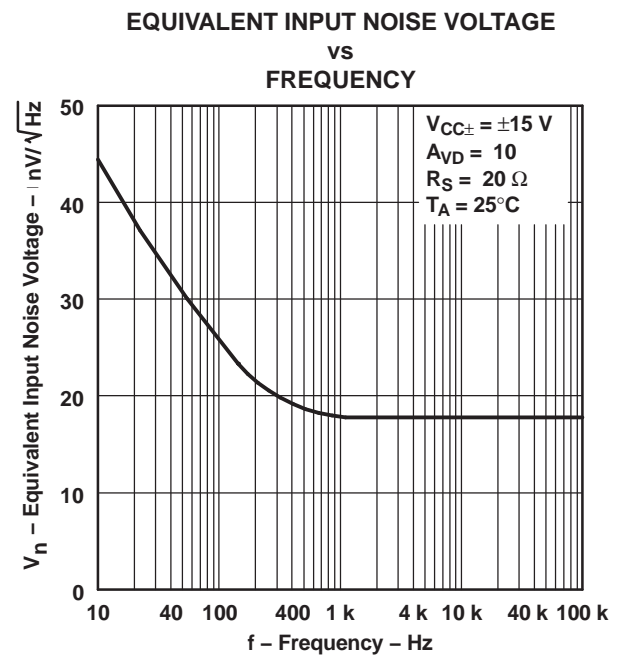

Figure 18.

**TYPICAL CHARACTERISTICS (continued)**

Data at high and low temperatures are applicable only within the rated operating free-air temperature ranges of the various devices.

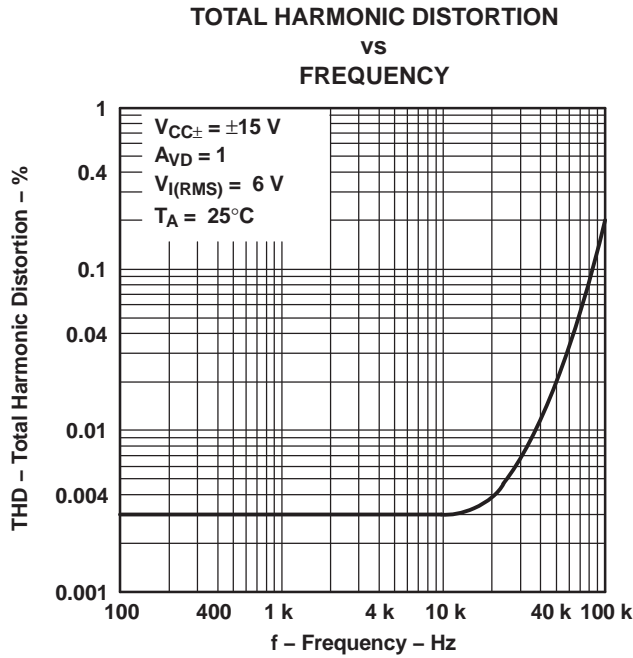

Figure 19.

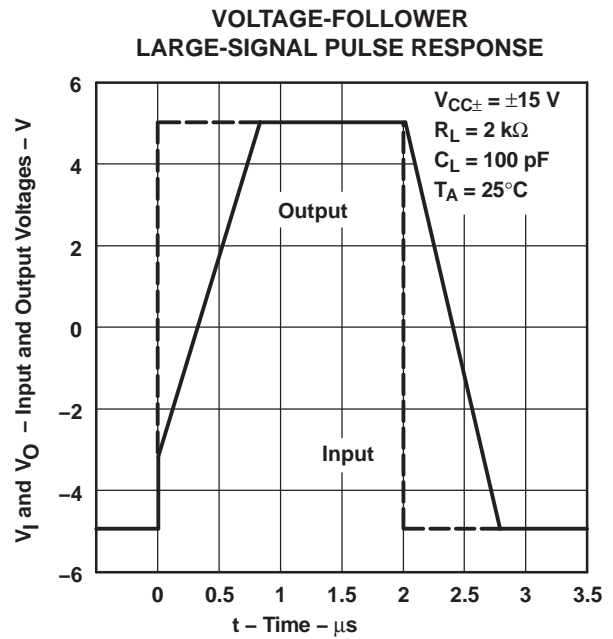

Figure 20.

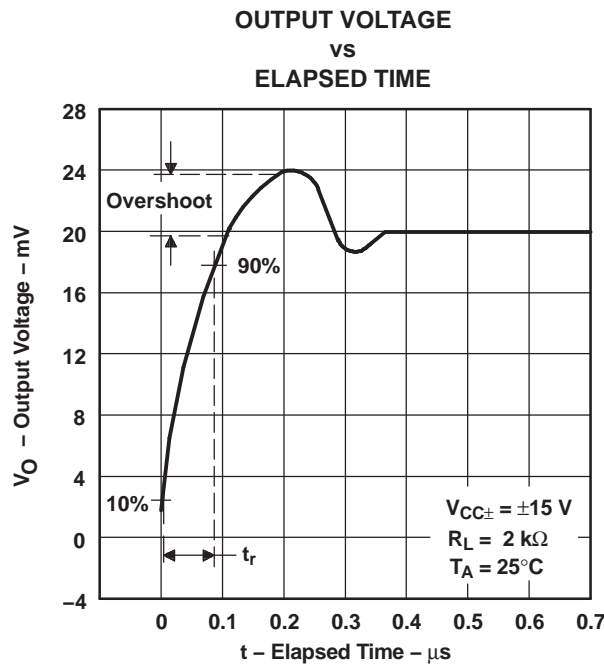
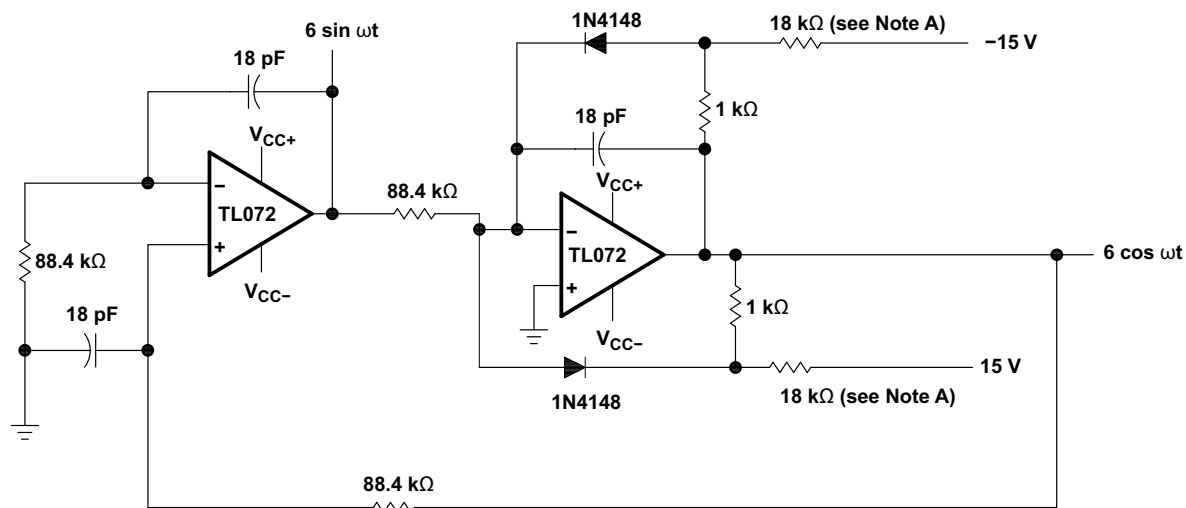

Figure 21.

APPLICATION INFORMATION



NOTE A: These resistor values may be adjusted for a symmetrical output.

Figure 22. 100-kHz Quadrature Oscillator

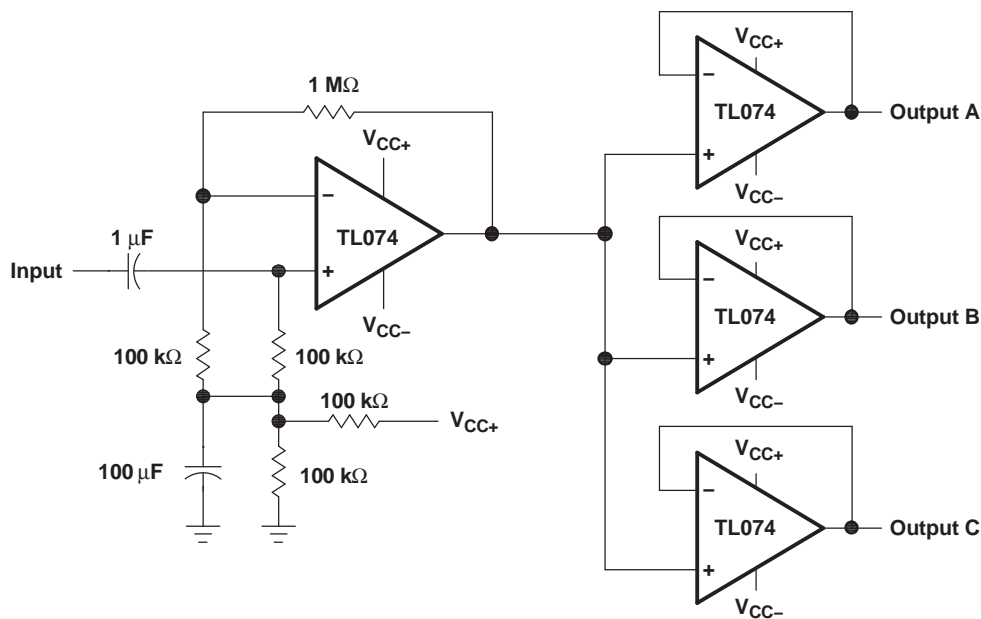

Figure 23. Audio-Distribution Amplifier

**PACKAGING INFORMATION**

Orderable Device	Status (1)	Package Type	Package Drawing	Pins	Package Qty	Eco Plan (2)	Lead/Ball Finish	MSL Peak Temp (3)	Op Temp (°C)	Device Marking (4/5)	Samples
TL072QDREP	ACTIVE	SOIC	D	8	2500	Green (RoHS & no Sb/Br)	CU NIPDAU	Level-1-260C-UNLIM	-40 to 125	TL072Q	<a href="#">Samples</a>
TL074MDEP	ACTIVE	SOIC	D	14	50	Green (RoHS & no Sb/Br)	CU NIPDAU	Level-1-260C-UNLIM	-55 to 125	TL074M	<a href="#">Samples</a>
TL074MDREP	ACTIVE	SOIC	D	14	2500	Green (RoHS & no Sb/Br)	CU NIPDAU	Level-1-260C-UNLIM	-55 to 125	TL074M	<a href="#">Samples</a>
TL074QDREP	ACTIVE	SOIC	D	14	2500	Green (RoHS & no Sb/Br)	CU NIPDAU	Level-1-260C-UNLIM	-40 to 125	TL074Q	<a href="#">Samples</a>
V62/11621-01XE	ACTIVE	SOIC	D	14	2500	Green (RoHS & no Sb/Br)	CU NIPDAU	Level-1-260C-UNLIM	-40 to 125	TL074Q	<a href="#">Samples</a>
V62/11621-02XE	ACTIVE	SOIC	D	14	2500	Green (RoHS & no Sb/Br)	CU NIPDAU	Level-1-260C-UNLIM	-55 to 125	TL074M	<a href="#">Samples</a>
V62/11621-02XE-T	ACTIVE	SOIC	D	14	50	Green (RoHS & no Sb/Br)	CU NIPDAU	Level-1-260C-UNLIM	-55 to 125	TL074M	<a href="#">Samples</a>
V62/12604-01XE	ACTIVE	SOIC	D	8	2500	Green (RoHS & no Sb/Br)	CU NIPDAU	Level-1-260C-UNLIM	-40 to 125	TL072Q	<a href="#">Samples</a>

(1) The marketing status values are defined as follows:

**ACTIVE:** Product device recommended for new designs.

**LIFEBUY:** TI has announced that the device will be discontinued, and a lifetime-buy period is in effect.

**NRND:** Not recommended for new designs. Device is in production to support existing customers, but TI does not recommend using this part in a new design.

**PREVIEW:** Device has been announced but is not in production. Samples may or may not be available.

**OBSOLETE:** TI has discontinued the production of the device.

(2) Eco Plan - The planned eco-friendly classification: Pb-Free (RoHS), Pb-Free (RoHS Exempt), or Green (RoHS & no Sb/Br) - please check <http://www.ti.com/productcontent> for the latest availability information and additional product content details.

**TBD:** The Pb-Free/Green conversion plan has not been defined.

**Pb-Free (RoHS):** TI's terms "Lead-Free" or "Pb-Free" mean semiconductor products that are compatible with the current RoHS requirements for all 6 substances, including the requirement that lead not exceed 0.1% by weight in homogeneous materials. Where designed to be soldered at high temperatures, TI Pb-Free products are suitable for use in specified lead-free processes.

**Pb-Free (RoHS Exempt):** This component has a RoHS exemption for either 1) lead-based flip-chip solder bumps used between the die and package, or 2) lead-based die adhesive used between the die and leadframe. The component is otherwise considered Pb-Free (RoHS compatible) as defined above.

**Green (RoHS & no Sb/Br):** TI defines "Green" to mean Pb-Free (RoHS compatible), and free of Bromine (Br) and Antimony (Sb) based flame retardants (Br or Sb do not exceed 0.1% by weight in homogeneous material)

(3) MSL, Peak Temp. -- The Moisture Sensitivity Level rating according to the JEDEC industry standard classifications, and peak solder temperature.

(4) There may be additional marking, which relates to the logo, the lot trace code information, or the environmental category on the device.

(5) Multiple Device Markings will be inside parentheses. Only one Device Marking contained in parentheses and separated by a "~" will appear on a device. If a line is indented then it is a continuation of the previous line and the two combined represent the entire Device Marking for that device.

**Important Information and Disclaimer:**The information provided on this page represents TI's knowledge and belief as of the date that it is provided. TI bases its knowledge and belief on information provided by third parties, and makes no representation or warranty as to the accuracy of such information. Efforts are underway to better integrate information from third parties. TI has taken and continues to take reasonable steps to provide representative and accurate information but may not have conducted destructive testing or chemical analysis on incoming materials and chemicals. TI and TI suppliers consider certain information to be proprietary, and thus CAS numbers and other limited information may not be available for release.

In no event shall TI's liability arising out of such information exceed the total purchase price of the TI part(s) at issue in this document sold by TI to Customer on an annual basis.

**OTHER QUALIFIED VERSIONS OF TL072-EP, TL074-EP :**

- Catalog: [TL072](#), [TL074](#)
- Military: [TL072M](#), [TL074M](#)

NOTE: Qualified Version Definitions:

- Catalog - TI's standard catalog product
- Military - QML certified for Military and Defense Applications

## TAPE AND REEL INFORMATION



### QUADRANT ASSIGNMENTS FOR PIN 1 ORIENTATION IN TAPE



\*All dimensions are nominal

Device	Package Type	Package Drawing	Pins	SPQ	Reel Diameter (mm)	Reel Width W1 (mm)	A0 (mm)	B0 (mm)	K0 (mm)	P1 (mm)	W (mm)	Pin1 Quadrant
TL074MDREP	SOIC	D	14	2500	330.0	16.4	6.5	9.0	2.1	8.0	16.0	Q1
TL074QDREP	SOIC	D	14	2500	330.0	16.4	6.5	9.0	2.1	8.0	16.0	Q1

**TAPE AND REEL BOX DIMENSIONS**

\*All dimensions are nominal

Device	Package Type	Package Drawing	Pins	SPQ	Length (mm)	Width (mm)	Height (mm)
TL074MDREP	SOIC	D	14	2500	333.2	345.9	28.6
TL074QDREP	SOIC	D	14	2500	333.2	345.9	28.6

D (R-PDSO-G14)

PLASTIC SMALL OUTLINE



- NOTES:
- A. All linear dimensions are in inches (millimeters).
  - B. This drawing is subject to change without notice.
  - Body length does not include mold flash, protrusions, or gate burrs. Mold flash, protrusions, or gate burrs shall not exceed 0.006 (0,15) each side.
  - Body width does not include interlead flash. Interlead flash shall not exceed 0.017 (0,43) each side.
  - E. Reference JEDEC MS-012 variation AB.



D (R-PDSO-G8)

PLASTIC SMALL OUTLINE



4040047-3/M 06/11

- NOTES:
- A. All linear dimensions are in inches (millimeters).
  - B. This drawing is subject to change without notice.
  - $\triangle C$  Body length does not include mold flash, protrusions, or gate burrs. Mold flash, protrusions, or gate burrs shall not exceed 0.006 (0,15) each side.
  - $\triangle D$  Body width does not include interlead flash. Interlead flash shall not exceed 0.017 (0,43) each side.
  - E. Reference JEDEC MS-012 variation AA.

D (R-PDSO-G8)

PLASTIC SMALL OUTLINE



4211283-2/E 08/12

- NOTES:
- A. All linear dimensions are in millimeters.
  - B. This drawing is subject to change without notice.
  - C. Publication IPC-7351 is recommended for alternate designs.
  - D. Laser cutting apertures with trapezoidal walls and also rounding corners will offer better paste release. Customers should contact their board assembly site for stencil design recommendations. Refer to IPC-7525 for other stencil recommendations.
  - E. Customers should contact their board fabrication site for solder mask tolerances between and around signal pads.

## IMPORTANT NOTICE

Texas Instruments Incorporated and its subsidiaries (TI) reserve the right to make corrections, enhancements, improvements and other changes to its semiconductor products and services per JESD46, latest issue, and to discontinue any product or service per JESD48, latest issue. Buyers should obtain the latest relevant information before placing orders and should verify that such information is current and complete. All semiconductor products (also referred to herein as "components") are sold subject to TI's terms and conditions of sale supplied at the time of order acknowledgment.

TI warrants performance of its components to the specifications applicable at the time of sale, in accordance with the warranty in TI's terms and conditions of sale of semiconductor products. Testing and other quality control techniques are used to the extent TI deems necessary to support this warranty. Except where mandated by applicable law, testing of all parameters of each component is not necessarily performed.

TI assumes no liability for applications assistance or the design of Buyers' products. Buyers are responsible for their products and applications using TI components. To minimize the risks associated with Buyers' products and applications, Buyers should provide adequate design and operating safeguards.

TI does not warrant or represent that any license, either express or implied, is granted under any patent right, copyright, mask work right, or other intellectual property right relating to any combination, machine, or process in which TI components or services are used. Information published by TI regarding third-party products or services does not constitute a license to use such products or services or a warranty or endorsement thereof. Use of such information may require a license from a third party under the patents or other intellectual property of the third party, or a license from TI under the patents or other intellectual property of TI.

Reproduction of significant portions of TI information in TI data books or data sheets is permissible only if reproduction is without alteration and is accompanied by all associated warranties, conditions, limitations, and notices. TI is not responsible or liable for such altered documentation. Information of third parties may be subject to additional restrictions.

Resale of TI components or services with statements different from or beyond the parameters stated by TI for that component or service voids all express and any implied warranties for the associated TI component or service and is an unfair and deceptive business practice. TI is not responsible or liable for any such statements.

Buyer acknowledges and agrees that it is solely responsible for compliance with all legal, regulatory and safety-related requirements concerning its products, and any use of TI components in its applications, notwithstanding any applications-related information or support that may be provided by TI. Buyer represents and agrees that it has all the necessary expertise to create and implement safeguards which anticipate dangerous consequences of failures, monitor failures and their consequences, lessen the likelihood of failures that might cause harm and take appropriate remedial actions. Buyer will fully indemnify TI and its representatives against any damages arising out of the use of any TI components in safety-critical applications.

In some cases, TI components may be promoted specifically to facilitate safety-related applications. With such components, TI's goal is to help enable customers to design and create their own end-product solutions that meet applicable functional safety standards and requirements. Nonetheless, such components are subject to these terms.

No TI components are authorized for use in FDA Class III (or similar life-critical medical equipment) unless authorized officers of the parties have executed a special agreement specifically governing such use.

Only those TI components which TI has specifically designated as military grade or "enhanced plastic" are designed and intended for use in military/aerospace applications or environments. Buyer acknowledges and agrees that any military or aerospace use of TI components which have **not** been so designated is solely at the Buyer's risk, and that Buyer is solely responsible for compliance with all legal and regulatory requirements in connection with such use.

TI has specifically designated certain components as meeting ISO/TS16949 requirements, mainly for automotive use. In any case of use of non-designated products, TI will not be responsible for any failure to meet ISO/TS16949.

### Products

Audio	<a href="http://www.ti.com/audio">www.ti.com/audio</a>
Amplifiers	<a href="http://amplifier.ti.com">amplifier.ti.com</a>
Data Converters	<a href="http://dataconverter.ti.com">dataconverter.ti.com</a>
DLP® Products	<a href="http://www.dlp.com">www.dlp.com</a>
DSP	<a href="http://dsp.ti.com">dsp.ti.com</a>
Clocks and Timers	<a href="http://www.ti.com/clocks">www.ti.com/clocks</a>
Interface	<a href="http://interface.ti.com">interface.ti.com</a>
Logic	<a href="http://logic.ti.com">logic.ti.com</a>
Power Mgmt	<a href="http://power.ti.com">power.ti.com</a>
Microcontrollers	<a href="http://microcontroller.ti.com">microcontroller.ti.com</a>
RFID	<a href="http://www.ti-rfid.com">www.ti-rfid.com</a>
OMAP Applications Processors	<a href="http://www.ti.com/omap">www.ti.com/omap</a>
Wireless Connectivity	<a href="http://www.ti.com/wirelessconnectivity">www.ti.com/wirelessconnectivity</a>

### Applications

Automotive and Transportation	<a href="http://www.ti.com/automotive">www.ti.com/automotive</a>
Communications and Telecom	<a href="http://www.ti.com/communications">www.ti.com/communications</a>
Computers and Peripherals	<a href="http://www.ti.com/computers">www.ti.com/computers</a>
Consumer Electronics	<a href="http://www.ti.com/consumer-apps">www.ti.com/consumer-apps</a>
Energy and Lighting	<a href="http://www.ti.com/energy">www.ti.com/energy</a>
Industrial	<a href="http://www.ti.com/industrial">www.ti.com/industrial</a>
Medical	<a href="http://www.ti.com/medical">www.ti.com/medical</a>
Security	<a href="http://www.ti.com/security">www.ti.com/security</a>
Space, Avionics and Defense	<a href="http://www.ti.com/space-avionics-defense">www.ti.com/space-avionics-defense</a>
Video and Imaging	<a href="http://www.ti.com/video">www.ti.com/video</a>

### TI E2E Community

[e2e.ti.com](http://e2e.ti.com)