

# TLC080, TLC081, TLC082, TLC083, TLC084, TLC085, TLC08xA FAMILY OF WIDE-BANDWIDTH HIGH-OUTPUT-DRIVE SINGLE SUPPLY OPERATIONAL AMPLIFIERS

SLOS254D – JUNE 1999 – REVISED FEBRUARY 2004

- **Wide Bandwidth . . . 10 MHz**
- **High Output Drive**
  - $I_{OH}$  . . . 57 mA at  $V_{DD} - 1.5$  V
  - $I_{OL}$  . . . 55 mA at 0.5 V
- **High Slew Rate**
  - $SR+$  . . . 16 V/ $\mu$ s
  - $SR-$  . . . 19 V/ $\mu$ s
- **Wide Supply Range . . . 4.5 V to 16 V**
- **Supply Current . . . 1.9 mA/Channel**
- **Ultralow Power Shutdown Mode**
  - $I_{DD}$  . . . 125  $\mu$ A/Channel
- **Low Input Noise Voltage . . . 8.5 nV $\sqrt$ Hz**
- **Input Offset Voltage . . . 60  $\mu$ V**
- **Ultra-Small Packages**
  - 8 or 10 Pin MSOP (TLC080/1/2/3)

Operational Amplifier

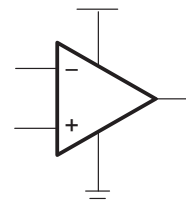

## description

The first members of TI's new BiMOS general-purpose operational amplifier family are the TLC08x. The BiMOS family concept is simple: provide an upgrade path for BiFET users who are moving away from dual-supply to single-supply systems and demand higher ac and dc performance. With performance rated from 4.5 V to 16 V across commercial (0°C to 70°C) and an extended industrial temperature range (–40°C to 125°C), BiMOS suits a wide range of audio, automotive, industrial, and instrumentation applications. Familiar features like offset nulling pins, and new features like MSOP PowerPAD™ packages and shutdown modes, enable higher levels of performance in a variety of applications.

Developed in TI's patented LBC3 BiCMOS process, the new BiMOS amplifiers combine a very high input impedance, low-noise CMOS front end with a high-drive bipolar output stage, thus providing the optimum performance features of both. AC performance improvements over the TL08x BiFET predecessors include a bandwidth of 10 MHz (an increase of 300%) and voltage noise of 8.5 nV/ $\sqrt$ Hz (an improvement of 60%). DC improvements include an ensured  $V_{ICR}$  that includes ground, a factor of 4 reduction in input offset voltage down to 1.5 mV (maximum) in the standard grade, and a power supply rejection improvement of greater than 40 dB to 130 dB. Added to this list of impressive features is the ability to drive  $\pm$ 50-mA loads comfortably from an ultrasmall-footprint MSOP PowerPAD package, which positions the TLC08x as the ideal high-performance general-purpose operational amplifier family.

FAMILY PACKAGE TABLE

DEVICE	NO. OF CHANNELS	PACKAGE TYPES				SHUTDOWN	UNIVERSAL EVM BOARD
		MSOP	PDIP	SOIC	TSSOP		
TLC080	1	8	8	8	—	Yes	Refer to the EVM Selection Guide (Lit# SLOU060)
TLC081	1	8	8	8	—	—	
TLC082	2	8	8	8	—	—	
TLC083	2	10	14	14	—	Yes	
TLC084	4	—	14	14	20	—	
TLC085	4	—	16	16	20	Yes	



Please be aware that an important notice concerning availability, standard warranty, and use in critical applications of Texas Instruments semiconductor products and disclaimers thereto appears at the end of this data sheet.

PowerPAD is a trademark of Texas Instruments.

PRODUCTION DATA information is current as of publication date. Products conform to specifications per the terms of Texas Instruments standard warranty. Production processing does not necessarily include testing of all parameters.



Copyright © 2000–2004 Texas Instruments Incorporated

# TLC080, TLC081, TLC082, TLC083, TLC084, TLC085, TLC08xA FAMILY OF WIDE-BANDWIDTH HIGH-OUTPUT-DRIVE SINGLE SUPPLY OPERATIONAL AMPLIFIERS

SLOS254D – JUNE 1999 – REVISED FEBRUARY 2004

## TLC080 and TLC081 AVAILABLE OPTIONS

T <sub>A</sub>	PACKAGED DEVICES			
	SMALL OUTLINE (D) <sup>†</sup>	SMALL OUTLINE (DGN) <sup>†</sup>	SYMBOL	PLASTIC DIP (P)
0°C to 70°C	TLC080CD TLC081CD	TLC080CDGN TLC081CDGN	xxTIACW xxTIACY	TLC080CP TLC081CP
-40°C to 125°C	TLC080ID TLC081ID	TLC080IDGN TLC081IDGN	xxTIACX xxTIACZ	TLC080IP TLC081IP
	TLC080AID TLC081AID	— —	— —	TLC080AIP TLC081AIP

<sup>†</sup> This package is available taped and reeled. To order this packaging option, add an R suffix to the part number (e.g., TLC080CDR).

## TLC082 and TLC083 AVAILABLE OPTIONS

T <sub>A</sub>	PACKAGED DEVICES						
	SMALL OUTLINE (D) <sup>†</sup>	MSOP				PLASTIC DIP (N)	PLASTIC DIP (P)
		(DGN) <sup>†</sup>	SYMBOL <sup>‡</sup>	(DGQ) <sup>†</sup>	SYMBOL <sup>‡</sup>		
0°C to 70°C	TLC082CD TLC083CD	TLC082CDGN —	xxTIADZ —	— TLC083CDGQ	— xxTIAEB	— TLC083CN	TLC082CP —
-40°C to 125°C	TLC082ID TLC083ID	TLC082IDGN —	xxTIAEA —	— TLC083IDGQ	— xxTIAEC	— TLC083IN	TLC082IP —
	TLC082AID TLC083AID	— —	— —	— —	— —	— TLC083AIN	TLC082AIP —

<sup>†</sup> This package is available taped and reeled. To order this packaging option, add an R suffix to the part number (e.g., TLC082CDR).

<sup>‡</sup> xx represents the device date code.

## TLC084 and TLC085 AVAILABLE OPTIONS

T <sub>A</sub>	PACKAGED DEVICES		
	SMALL OUTLINE (D) <sup>†</sup>	PLASTIC DIP (N)	TSSOP (PWP) <sup>†</sup>
0°C to 70°C	TLC084CD TLC085CD	TLC084CN TLC085CN	TLC084CPWP TLC085CPWP
-40°C to 125°C	TLC084ID TLC085ID	TLC084IN TLC085IN	TLC084IPWP TLC085IPWP
	TLC084AID TLC085AID	TLC084AIN TLC085AIN	TLC084AIPWP TLC085AIPWP

<sup>†</sup> This package is available taped and reeled. To order this packaging option, add an R suffix to the part number (e.g., TLC084CDR).

# TLC080, TLC081, TLC082, TLC083, TLC084, TLC085, TLC08xA FAMILY OF WIDE-BANDWIDTH HIGH-OUTPUT-DRIVE SINGLE SUPPLY OPERATIONAL AMPLIFIERS

SLOS254D – JUNE 1999 – REVISED FEBRUARY 2004

## TLC08x PACKAGE PINOUTS

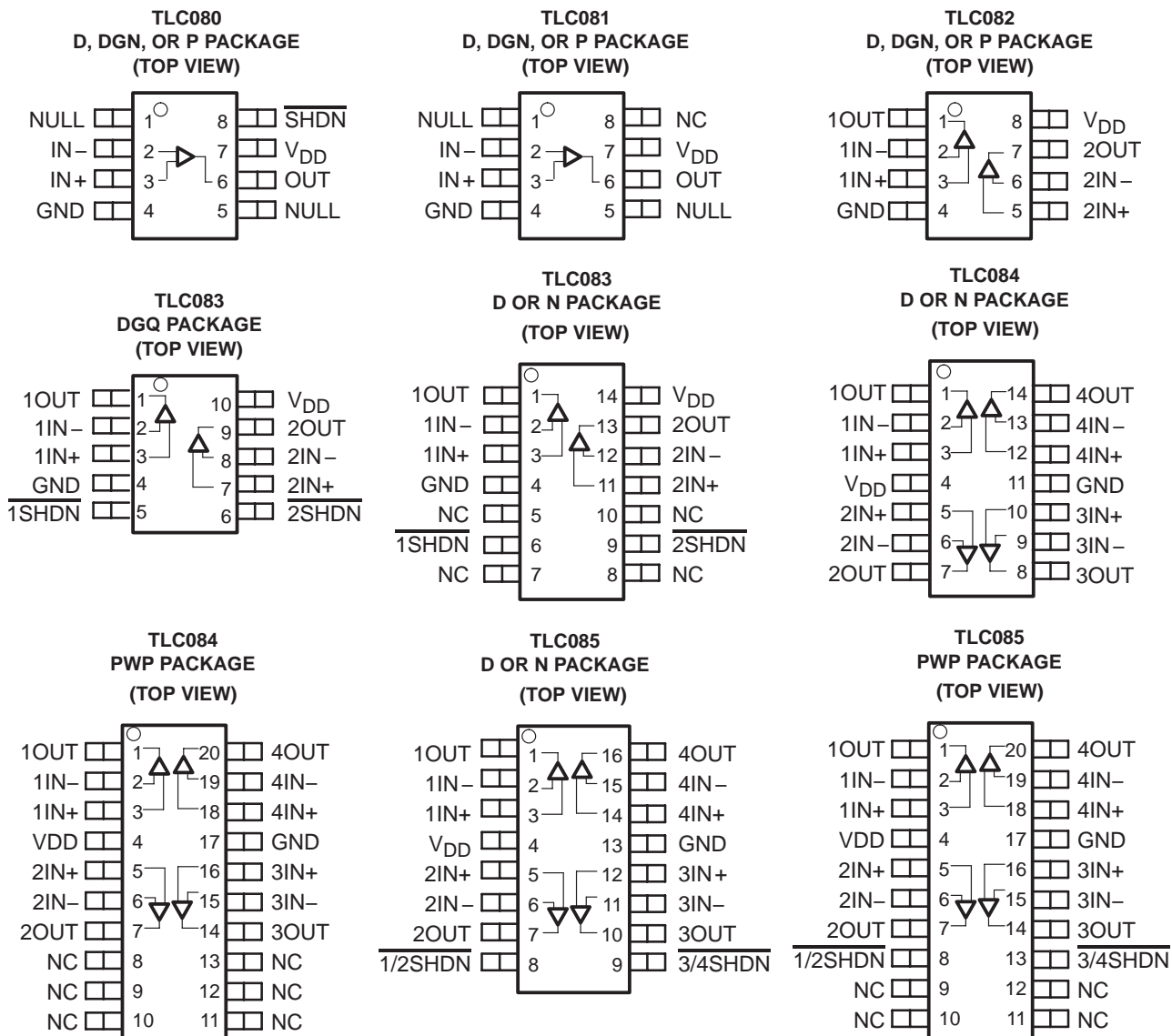

NC – No internal connection

## TYPICAL PIN 1 INDICATORS

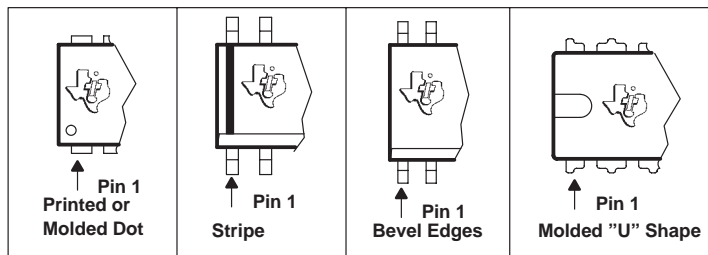

# TLC080, TLC081, TLC082, TLC083, TLC084, TLC085, TLC08xA FAMILY OF WIDE-BANDWIDTH HIGH-OUTPUT-DRIVE SINGLE SUPPLY OPERATIONAL AMPLIFIERS

SLOS254D – JUNE 1999 – REVISED FEBRUARY 2004

## absolute maximum ratings over operating free-air temperature range (unless otherwise noted)†

Supply voltage, $V_{DD}$ (see Note 1)	17 V
Differential input voltage range, $V_{ID}$	$\pm V_{DD}$
Continuous total power dissipation	See Dissipation Rating Table
Operating free-air temperature range, $T_A$ : C suffix	0°C to 70°C
I suffix	-40°C to 125°C
Maximum junction temperature, $T_J$	150°C
Storage temperature range, $T_{stg}$	-65°C to 150°C
Lead temperature 1,6 mm (1/16 inch) from case for 10 seconds	260°C

† Stresses beyond those listed under “absolute maximum ratings” may cause permanent damage to the device. These are stress ratings only, and functional operation of the device at these or any other conditions beyond those indicated under “recommended operating conditions” is not implied. Exposure to absolute-maximum-rated conditions for extended periods may affect device reliability.

NOTE 1: All voltage values, except differential voltages, are with respect to GND.

DISSIPATION RATING TABLE

PACKAGE	$\theta_{JC}$ (°C/W)	$\theta_{JA}$ (°C/W)	$T_A \leq 25^\circ\text{C}$ POWER RATING
D (8)	38.3	176	710 mW
D (14)	26.9	122.3	1022 mW
D (16)	25.7	114.7	1090 mW
DGN (8)	4.7	52.7	2.37 W
DGQ (10)	4.7	52.3	2.39 W
N (14, 16)	32	78	1600 mW
P (8)	41	104	1200 mW
PWP (20)	1.40	26.1	4.79 W

## recommended operating conditions

		MIN	MAX	UNIT
Supply voltage, $V_{DD}$	Single supply	4.5	16	V
	Split supply	$\pm 2.25$	$\pm 8$	
Common-mode input voltage, $V_{ICR}$		GND	$V_{DD}-2$	V
Shutdown on/off voltage level‡	$V_{IH}$	2		V
	$V_{IL}$	0.8		
Operating free-air temperature, $T_A$	C-suffix	0	70	°C
	I-suffix	-40	125	

‡ Relative to the voltage on the GND terminal of the device.

# TLC080, TLC081, TLC082, TLC083, TLC084, TLC085, TLC08xA FAMILY OF WIDE-BANDWIDTH HIGH-OUTPUT-DRIVE SINGLE SUPPLY OPERATIONAL AMPLIFIERS

SLOS254D – JUNE 1999 – REVISED FEBRUARY 2004

electrical characteristics at specified free-air temperature,  $V_{DD} = 5\text{ V}$  (unless otherwise noted)

PARAMETER		TEST CONDITIONS		$T_A$ †	MIN	TYP	MAX	UNIT
$V_{IO}$	Input offset voltage	$V_{DD} = 5\text{ V}$ , $V_{IC} = 2.5\text{ V}$ , $V_O = 2.5\text{ V}$ , $R_S = 50\ \Omega$	TLC080/1/2/3, TLC084/5	25°C		390	1900	$\mu\text{V}$
				Full range			3000	
			TLC080/1/2/3A, TLC084/5A	25°C		390	1400	
				Full range			2000	
$\alpha_{VIO}$	Temperature coefficient of input offset voltage					1.2	$\mu\text{V}/^\circ\text{C}$	
$I_{IO}$	Input offset current	$V_{DD} = 5\text{ V}$ , $V_{IC} = 2.5\text{ V}$ , $V_O = 2.5\text{ V}$ , $R_S = 50\ \Omega$		25°C		1.9	50	$\text{pA}$
			TLC08XC TLC08XI	Full range			100 700	
$I_{IB}$	Input bias current	$V_{DD} = 5\text{ V}$ , $V_{IC} = 2.5\text{ V}$ , $V_O = 2.5\text{ V}$ , $R_S = 50\ \Omega$		25°C		3	50	$\text{pA}$
			TLC08XC TLC08XI	Full range			100 700	
$V_{ICR}$	Common-mode input voltage	$R_S = 50\ \Omega$		25°C	0 to 3.0	0 to 3.5		$\text{V}$
				Full range			0 to 3.0	
$V_{OH}$	High-level output voltage	$V_{IC} = 2.5\text{ V}$	$I_{OH} = -1\text{ mA}$	25°C	4.1	4.3		$\text{V}$
				Full range	3.9			
			$I_{OH} = -20\text{ mA}$	25°C	3.7	4		
				Full range	3.5			
			$I_{OH} = -35\text{ mA}$	25°C	3.4	3.8		
				Full range	3.2			
$I_{OH} = -50\text{ mA}$	25°C	3.2	3.6					
	-40°C to 85°C	3						
$V_{OL}$	Low-level output voltage	$V_{IC} = 2.5\text{ V}$	$I_{OL} = 1\text{ mA}$	25°C		0.18	0.25	$\text{V}$
				Full range			0.35	
			$I_{OL} = 20\text{ mA}$	25°C		0.35	0.39	
				Full range			0.45	
			$I_{OL} = 35\text{ mA}$	25°C		0.43	0.55	
				Full range			0.7	
			$I_{OL} = 50\text{ mA}$	25°C		0.45	0.63	
				-40°C to 85°C			0.7	
$I_{OS}$	Short-circuit output current	Sourcing	25°C		100		$\text{mA}$	
		Sinking	25°C		100			
$I_O$	Output current	$V_{OH} = 1.5\text{ V}$ from positive rail	25°C		57		$\text{mA}$	
		$V_{OL} = 0.5\text{ V}$ from negative rail	25°C		55			

† Full range is 0°C to 70°C for C suffix and -40°C to 125°C for I suffix. If not specified, full range is -40°C to 125°C.

**TLC080, TLC081, TLC082, TLC083, TLC084, TLC085, TLC08xA**  
**FAMILY OF WIDE-BANDWIDTH HIGH-OUTPUT-DRIVE SINGLE SUPPLY**  
**OPERATIONAL AMPLIFIERS**

SLOS254D – JUNE 1999 – REVISED FEBRUARY 2004

**electrical characteristics at specified free-air temperature,  $V_{DD} = 5\text{ V}$  (unless otherwise noted)**  
**(continued)**

PARAMETER		TEST CONDITIONS	$T_A^\dagger$	MIN	TYP	MAX	UNIT
$A_{VD}$	Large-signal differential voltage amplification	$V_{O(PP)} = 3\text{ V}$ , $R_L = 10\text{ k}\Omega$	25°C	100	120		dB
			Full range	100			
$r_{i(d)}$	Differential input resistance		25°C		1000		$G\Omega$
$C_{IC}$	Common-mode input capacitance	$f = 10\text{ kHz}$	25°C		22.9		pF
$z_o$	Closed-loop output impedance	$f = 10\text{ kHz}$ , $A_V = 10$	25°C		0.25		$\Omega$
CMRR	Common-mode rejection ratio	$V_{IC} = 0\text{ to }3\text{ V}$ , $R_S = 50\ \Omega$	25°C	80	110		dB
			Full range	80			
$k_{SVR}$	Supply voltage rejection ratio ( $\Delta V_{DD} / \Delta V_{IO}$ )	$V_{DD} = 4.5\text{ V to }16\text{ V}$ , No load $V_{IC} = V_{DD}/2$ ,	25°C	80	100		dB
			Full range	80			
$I_{DD}$	Supply current (per channel)	$V_O = 2.5\text{ V}$ , No load	25°C		1.8	2.5	mA
			Full range			3.5	
$I_{DD(SHDN)}$	Supply current in shutdown mode (per channel) (TLC080, TLC083, TLC085)	$\overline{\text{SHDN}} \leq 0.8\text{ V}$	25°C		125	200	$\mu\text{A}$
			Full range			250	

$^\dagger$  Full range is 0°C to 70°C for C suffix and –40°C to 125°C for I suffix. If not specified, full range is –40°C to 125°C.

**TLC080, TLC081, TLC082, TLC083, TLC084, TLC085, TLC08xA**  
**FAMILY OF WIDE-BANDWIDTH HIGH-OUTPUT-DRIVE SINGLE SUPPLY**  
**OPERATIONAL AMPLIFIERS**

SLOS254D – JUNE 1999 – REVISED FEBRUARY 2004

**operating characteristics at specified free-air temperature,  $V_{DD} = 5\text{ V}$  (unless otherwise noted)**

PARAMETER		TEST CONDITIONS		$T_A$ †	MIN	TYP	MAX	UNIT
SR+	Positive slew rate at unity gain	$V_{O(PP)} = 0.8\text{ V}$ , $R_L = 10\text{ k}\Omega$	$C_L = 50\text{ pF}$	25°C	10	16		V/ $\mu\text{s}$
				Full range	9.5			
SR–	Negative slew rate at unity gain	$V_{O(PP)} = 0.8\text{ V}$ , $R_L = 10\text{ k}\Omega$	$C_L = 50\text{ pF}$	25°C	12.5	19		V/ $\mu\text{s}$
				Full range	10			
$V_n$	Equivalent input noise voltage			25°C	12			nV/ $\sqrt{\text{Hz}}$
				25°C	8.5			
$I_n$	Equivalent input noise current	$f = 1\text{ kHz}$		25°C	0.6		fA/ $\sqrt{\text{Hz}}$	
THD + N	Total harmonic distortion plus noise	$V_{O(PP)} = 3\text{ V}$ , $R_L = 10\text{ k}\Omega$ and $250\ \Omega$ , $f = 1\text{ kHz}$	$A_V = 1$	25°C	0.002%			
			$A_V = 10$		0.012%			
			$A_V = 100$		0.085%			
$t_{(on)}$	Amplifier turnon time‡	$R_L = 10\text{ k}\Omega$		25°C	0.15		$\mu\text{s}$	
$t_{(off)}$	Amplifier turnoff time‡			25°C	1.3		$\mu\text{s}$	
Gain-bandwidth product		$f = 10\text{ kHz}$ ,	$R_L = 10\text{ k}\Omega$	25°C	10		MHz	
$t_s$	Settling time	$V_{(STEP)PP} = 1\text{ V}$ , $A_V = -1$ , $C_L = 10\text{ pF}$ , $R_L = 10\text{ k}\Omega$	0.1%	25°C	0.18		$\mu\text{s}$	
			0.01%		0.39			
		$V_{(STEP)PP} = 1\text{ V}$ , $A_V = -1$ , $C_L = 47\text{ pF}$ , $R_L = 10\text{ k}\Omega$	0.1%		0.18			
			0.01%		0.39			
$\phi_m$	Phase margin	$R_L = 10\text{ k}\Omega$ ,	$C_L = 50\text{ pF}$	25°C	32°			
		$R_L = 10\text{ k}\Omega$ ,	$C_L = 0\text{ pF}$		40°			
	Gain margin	$R_L = 10\text{ k}\Omega$ ,	$C_L = 50\text{ pF}$	25°C	2.2		dB	
		$R_L = 10\text{ k}\Omega$ ,	$C_L = 0\text{ pF}$		3.3			

† Full range is 0°C to 70°C for C suffix and –40°C to 125°C for I suffix. If not specified, full range is –40°C to 125°C.

‡ Disable time and enable time are defined as the interval between application of the logic signal to SHDN and the point at which the supply current has reached half its final value.

**TLC080, TLC081, TLC082, TLC083, TLC084, TLC085, TLC08xA**  
**FAMILY OF WIDE-BANDWIDTH HIGH-OUTPUT-DRIVE SINGLE SUPPLY**  
**OPERATIONAL AMPLIFIERS**

SLOS254D – JUNE 1999 – REVISED FEBRUARY 2004

electrical characteristics at specified free-air temperature,  $V_{DD} = 12\text{ V}$  (unless otherwise noted)

PARAMETER		TEST CONDITIONS		$T_A$ †	MIN	TYP	MAX	UNIT
$V_{IO}$	Input offset voltage	$V_{DD} = 12\text{ V}$ $V_{IC} = 6\text{ V}$ , $V_O = 6\text{ V}$ , $R_S = 50\ \Omega$	TLC0841/2/3, TLC084/5	25°C	390	1900	$\mu\text{V}$	
				Full range	3000			
			TLC0841/2/3A, TLC084/5A	25°C	390	1400		
				Full range	2000			
$\alpha_{VIO}$	Temperature coefficient of input offset voltage				1.2		$\mu\text{V}/^\circ\text{C}$	
$I_{IO}$	Input offset current	$V_{DD} = 12\text{ V}$ $V_{IC} = 6\text{ V}$ , $V_O = 6\text{ V}$ , $R_S = 50\ \Omega$	TLC08xC	Full range	25°C	1.5	50	$\text{pA}$
			TLC08xI		100	700		
$I_{IB}$	Input bias current	$V_{DD} = 12\text{ V}$ $V_{IC} = 6\text{ V}$ , $V_O = 6\text{ V}$ , $R_S = 50\ \Omega$	TLC08xC	Full range	25°C	2	50	$\text{pA}$
			TLC08xI		100	700		
$V_{ICR}$	Common-mode input voltage	$R_S = 50\ \Omega$		25°C	0 to 10.0	0 to 10.5	$\text{V}$	
				Full range	0 to 10.0	0 to 10.5		
$V_{OH}$	High-level output voltage	$V_{IC} = 6\text{ V}$	$I_{OH} = -1\text{ mA}$	25°C	11.1	11.2	$\text{V}$	
				Full range	11			
			$I_{OH} = -20\text{ mA}$	25°C	10.8	11		
				Full range	10.7			
			$I_{OH} = -35\text{ mA}$	25°C	10.6	10.7		
				Full range	10.3			
			$I_{OH} = -50\text{ mA}$	25°C	10.3	10.5		
				-40°C to 85°C	10.2			
$V_{OL}$	Low-level output voltage	$V_{IC} = 6\text{ V}$	$I_{OL} = 1\text{ mA}$	25°C	0.17	0.25	$\text{V}$	
				Full range	0.35			
			$I_{OL} = 20\text{ mA}$	25°C	0.35	0.45		
				Full range	0.5			
			$I_{OL} = 35\text{ mA}$	25°C	0.4	0.52		
				Full range	0.6			
			$I_{OL} = 50\text{ mA}$	25°C	0.45	0.6		
				-40°C to 85°C	0.65			
$I_{OS}$	Short-circuit output current	Sourcing	25°C	150	$\text{mA}$			
		Sinking	25°C	150				
$I_O$	Output current	$V_{OH} = 1.5\text{ V}$ from positive rail	25°C	57	$\text{mA}$			
		$V_{OL} = 0.5\text{ V}$ from negative rail	25°C	55				

† Full range is 0°C to 70°C for C suffix and -40°C to 125°C for I suffix. If not specified, full range is -40°C to 125°C.



**TLC080, TLC081, TLC082, TLC083, TLC084, TLC085, TLC08xA**  
**FAMILY OF WIDE-BANDWIDTH HIGH-OUTPUT-DRIVE SINGLE SUPPLY**  
**OPERATIONAL AMPLIFIERS**

SLOS254D – JUNE 1999 – REVISED FEBRUARY 2004

**electrical characteristics at specified free-air temperature,  $V_{DD} = 12\text{ V}$  (unless otherwise noted)**  
**(continued)**

PARAMETER		TEST CONDITIONS	$T_A$ †	MIN	TYP	MAX	UNIT
$A_{VD}$	Large-signal differential voltage amplification	$V_{O(PP)} = 8\text{ V}$ , $R_L = 10\text{ k}\Omega$	25°C	120	140		dB
			Full range	120			
$r_{i(d)}$	Differential input resistance		25°C		1000		G $\Omega$
$C_{IC}$	Common-mode input capacitance	$f = 10\text{ kHz}$	25°C		21.6		pF
$z_o$	Closed-loop output impedance	$f = 10\text{ kHz}$ , $A_V = 10$	25°C		0.25		$\Omega$
CMRR	Common-mode rejection ratio	$V_{IC} = 0\text{ to }10\text{ V}$ , $R_S = 50\ \Omega$	25°C	80	110		dB
			Full range	80			
$k_{SVR}$	Supply voltage rejection ratio ( $\Delta V_{DD} / \Delta V_{IO}$ )	$V_{DD} = 4.5\text{ V to }16\text{ V}$ , No load $V_{IC} = V_{DD}/2$	25°C	80	100		dB
			Full range	80			
$I_{DD}$	Supply current (per channel)	$V_O = 7.5\text{ V}$ , No load	25°C		1.9	2.9	mA
			Full range			3.5	
$I_{DD(SHDN)}$	Supply current in shutdown mode (TLC080, TLC083, TLC085) (per channel)	$\overline{SHDN} \leq 0.8\text{ V}$	25°C		125	200	$\mu\text{A}$
			Full range			250	

† Full range is 0°C to 70°C for C suffix and –40°C to 125°C for I suffix. If not specified, full range is –40°C to 125°C.

**TLC080, TLC081, TLC082, TLC083, TLC084, TLC085, TLC08xA**  
**FAMILY OF WIDE-BANDWIDTH HIGH-OUTPUT-DRIVE SINGLE SUPPLY**  
**OPERATIONAL AMPLIFIERS**

SLOS254D – JUNE 1999 – REVISED FEBRUARY 2004

operating characteristics at specified free-air temperature,  $V_{DD} = 12\text{ V}$  (unless otherwise noted)

PARAMETER		TEST CONDITIONS		$T_A$ †	MIN	TYP	MAX	UNIT
SR+	Positive slew rate at unity gain	$V_{O(PP)} = 2\text{ V}$ , $R_L = 10\text{ k}\Omega$	$C_L = 50\text{ pF}$	25°C	10	16		V/ $\mu\text{s}$
				Full range	9.5			
SR–	Negative slew rate at unity gain	$V_{O(PP)} = 2\text{ V}$ , $R_L = 10\text{ k}\Omega$	$C_L = 50\text{ pF}$	25°C	12.5	19		V/ $\mu\text{s}$
				Full range	10			
$V_n$	Equivalent input noise voltage	$f = 100\text{ Hz}$		25°C	14			nV/ $\sqrt{\text{Hz}}$
				25°C	8.5			
$I_n$	Equivalent input noise current	$f = 1\text{ kHz}$		25°C	0.6			fA/ $\sqrt{\text{Hz}}$
THD + N	Total harmonic distortion plus noise	$V_{O(PP)} = 8\text{ V}$ , $R_L = 10\text{ k}\Omega$ and $250\ \Omega$ , $f = 1\text{ kHz}$	$A_V = 1$	25°C	0.002%			
					$A_V = 10$	0.005%		
						$A_V = 100$	0.022%	
$t_{(on)}$	Amplifier turnon time‡	$R_L = 10\text{ k}\Omega$		25°C	0.47			$\mu\text{s}$
$t_{(off)}$	Amplifier turnoff time‡			25°C	2.5			$\mu\text{s}$
Gain-bandwidth product		$f = 10\text{ kHz}$ ,	$R_L = 10\text{ k}\Omega$	25°C	10			MHz
$t_s$	Settling time	$V_{(STEP)PP} = 1\text{ V}$ , $A_V = -1$ , $C_L = 10\text{ pF}$ , $R_L = 10\text{ k}\Omega$	0.1%	25°C	0.17		$\mu\text{s}$	
			0.01%		0.22			
		$V_{(STEP)PP} = 1\text{ V}$ , $A_V = -1$ , $C_L = 47\text{ pF}$ , $R_L = 10\text{ k}\Omega$	0.1%		0.17			
			0.01%		0.29			
$\phi_m$	Phase margin	$R_L = 10\text{ k}\Omega$ ,	$C_L = 50\text{ pF}$	25°C	37°			
		$R_L = 10\text{ k}\Omega$ ,	$C_L = 0\text{ pF}$		42°			
	Gain margin	$R_L = 10\text{ k}\Omega$ ,	$C_L = 50\text{ pF}$	25°C	3.1		dB	
		$R_L = 10\text{ k}\Omega$ ,	$C_L = 0\text{ pF}$		4			

† Full range is 0°C to 70°C for C suffix and –40°C to 125°C for I suffix. If not specified, full range is –40°C to 125°C.

‡ Disable time and enable time are defined as the interval between application of the logic signal to SHDN and the point at which the supply current has reached half its final value.

**TLC080, TLC081, TLC082, TLC083, TLC084, TLC085, TLC08xA**  
**FAMILY OF WIDE-BANDWIDTH HIGH-OUTPUT-DRIVE SINGLE SUPPLY**  
**OPERATIONAL AMPLIFIERS**

SLOS254D – JUNE 1999 – REVISED FEBRUARY 2004

**TYPICAL CHARACTERISTICS**

**Table of Graphs**

			FIGURE
$V_{IO}$	Input offset voltage	vs Common-mode input voltage	1, 2
$I_{IO}$	Input offset current	vs Free-air temperature	3, 4
$I_{IB}$	Input bias current	vs Free-air temperature	3, 4
$V_{OH}$	High-level output voltage	vs High-level output current	5, 7
$V_{OL}$	Low-level output voltage	vs Low-level output current	6, 8
$Z_o$	Output impedance	vs Frequency	9
$I_{DD}$	Supply current	vs Supply voltage	10
PSRR	Power supply rejection ratio	vs Frequency	11
CMRR	Common-mode rejection ratio	vs Frequency	12
$V_n$	Equivalent input noise voltage	vs Frequency	13
$V_{O(PP)}$	Peak-to-peak output voltage	vs Frequency	14, 15
	Crosstalk	vs Frequency	16
	Differential voltage gain	vs Frequency	17, 18
	Phase	vs Frequency	17, 18
$\phi_m$	Phase margin	vs Load capacitance	19, 20
	Gain margin	vs Load capacitance	21, 22
	Gain-bandwidth product	vs Supply voltage	23
SR	Slew rate	vs Supply voltage	24
		vs Free-air temperature	25, 26
THD + N	Total harmonic distortion plus noise	vs Frequency	27, 28
		vs Peak-to-peak output voltage	29, 30
	Large-signal follower pulse response		31, 32
	Small-signal follower pulse response		33
	Large-signal inverting pulse response		34, 35
	Small-signal inverting pulse response		36
	Shutdown forward isolation	vs Frequency	37, 38
	Shutdown reverse isolation	vs Frequency	39, 40
	Shutdown supply current	vs Supply voltage	41
		vs Free-air temperature	42
	Shutdown pulse		43, 44

# TLC080, TLC081, TLC082, TLC083, TLC084, TLC085, TLC08xA FAMILY OF WIDE-BANDWIDTH HIGH-OUTPUT-DRIVE SINGLE SUPPLY OPERATIONAL AMPLIFIERS

SLOS254D – JUNE 1999 – REVISED FEBRUARY 2004

## TYPICAL CHARACTERISTICS

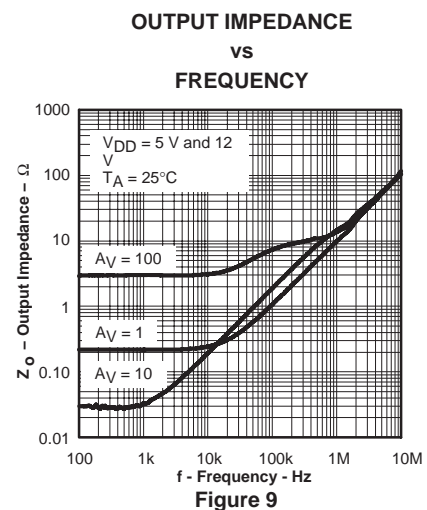
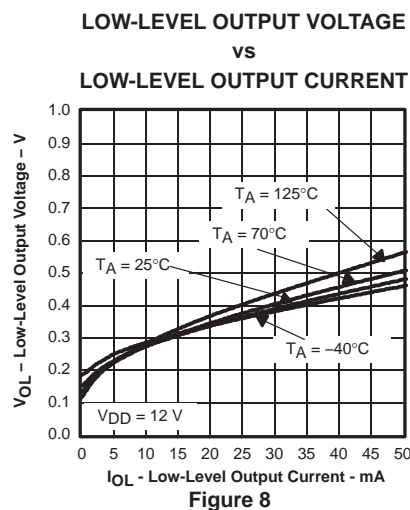
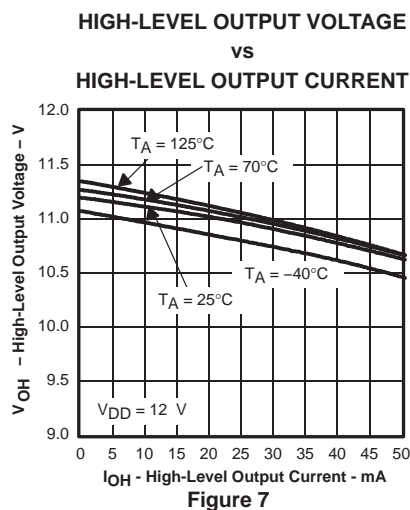
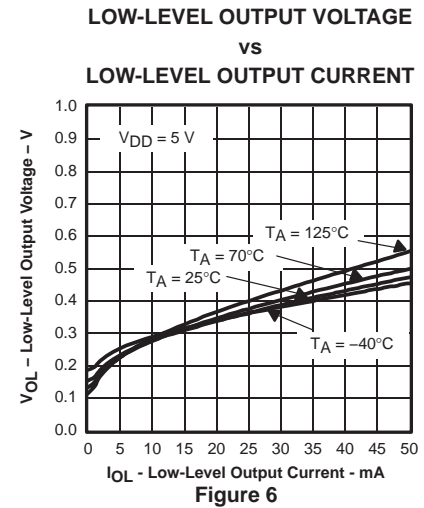
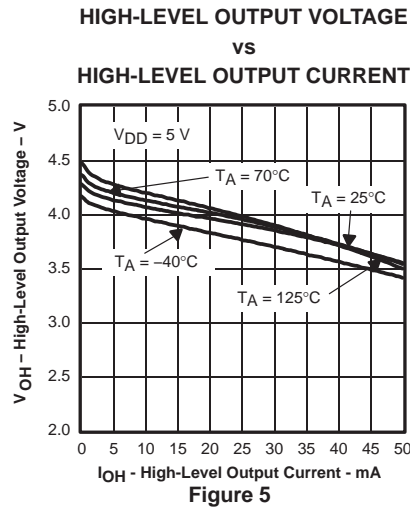
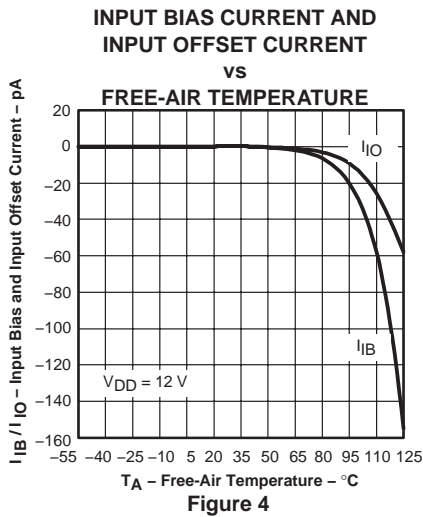
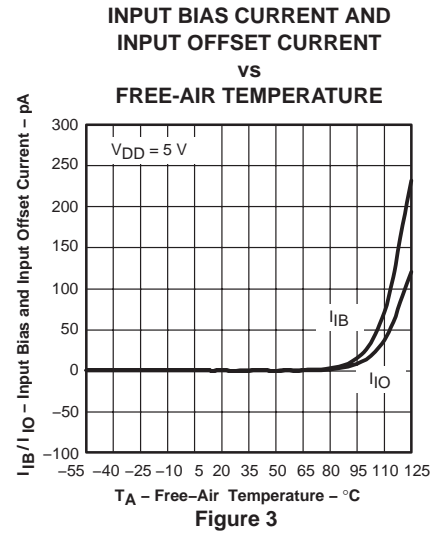
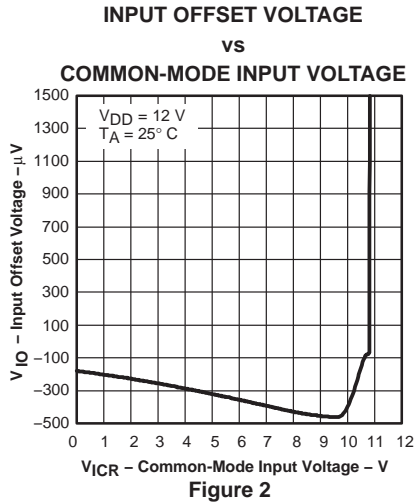
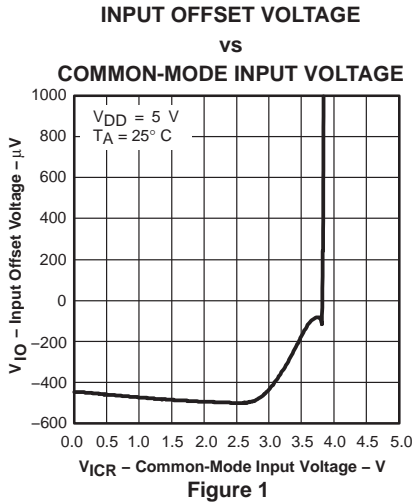

# TLC080, TLC081, TLC082, TLC083, TLC084, TLC085, TLC08xA FAMILY OF WIDE-BANDWIDTH HIGH-OUTPUT-DRIVE SINGLE SUPPLY OPERATIONAL AMPLIFIERS

SLOS254D – JUNE 1999 – REVISED FEBRUARY 2004

## TYPICAL CHARACTERISTICS

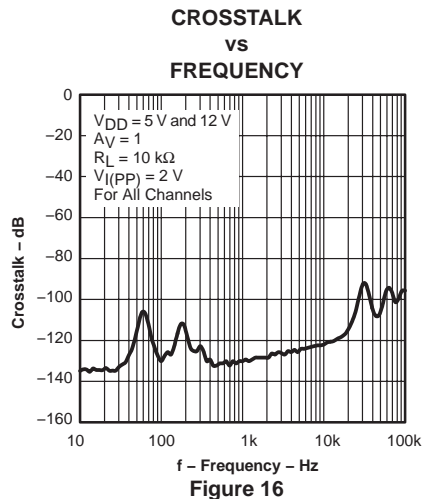
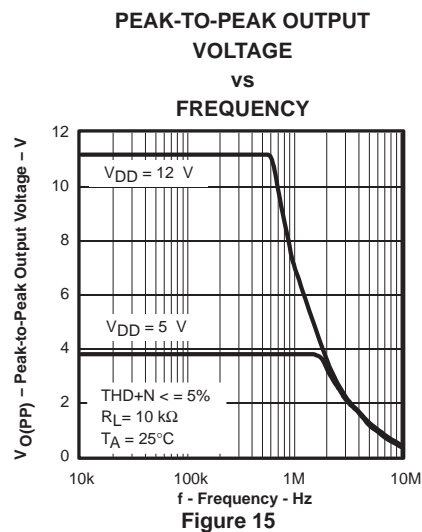
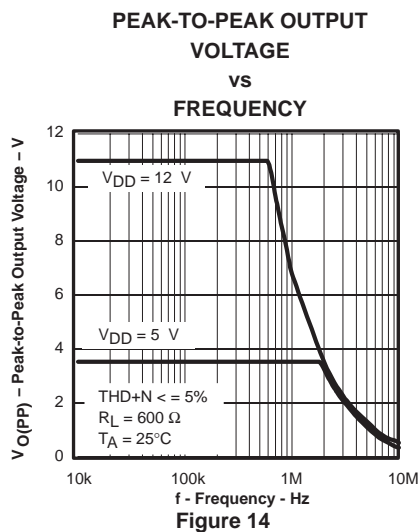
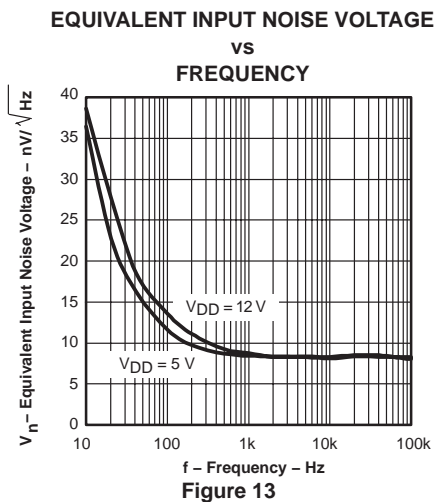
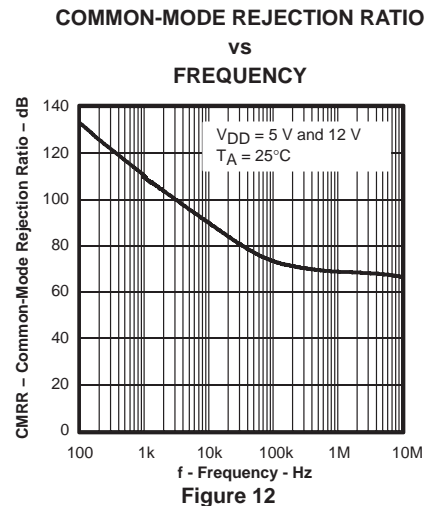
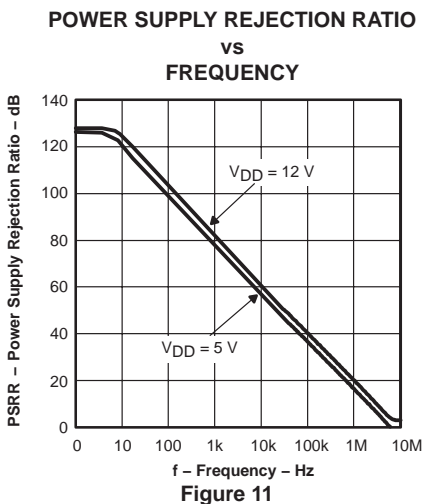
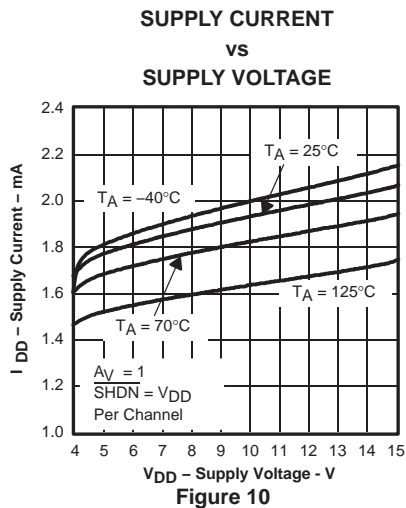

# TLC080, TLC081, TLC082, TLC083, TLC084, TLC085, TLC08xA FAMILY OF WIDE-BANDWIDTH HIGH-OUTPUT-DRIVE SINGLE SUPPLY OPERATIONAL AMPLIFIERS

SLOS254D – JUNE 1999 – REVISED FEBRUARY 2004

## TYPICAL CHARACTERISTICS

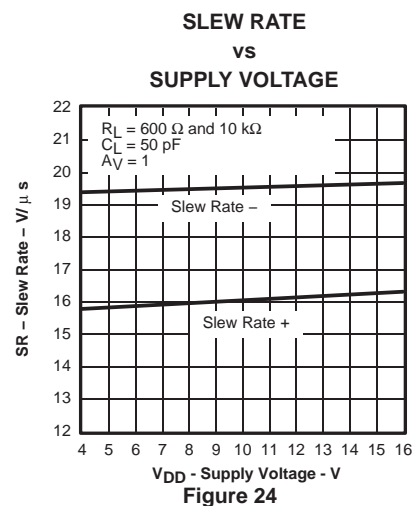
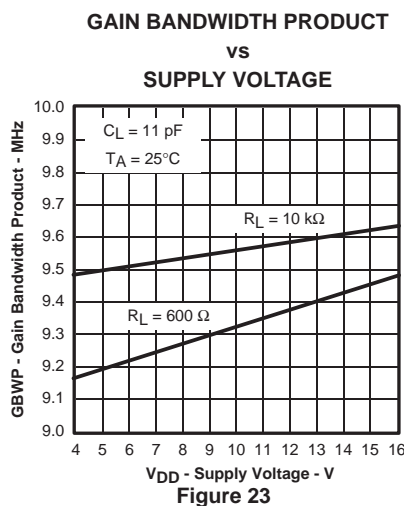
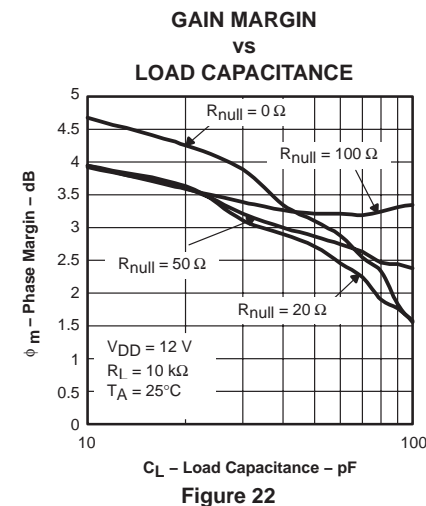
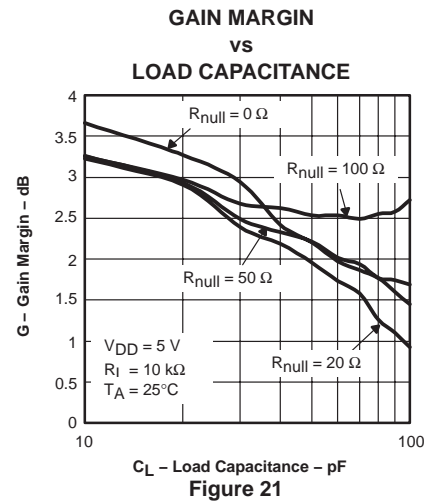
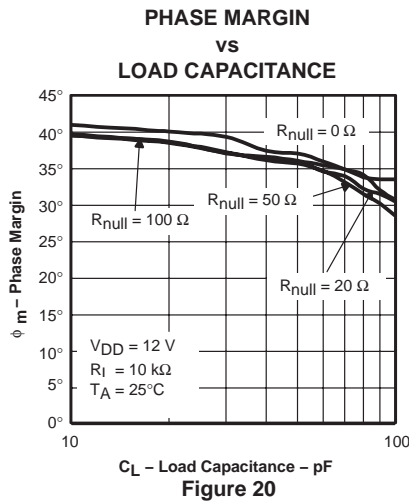
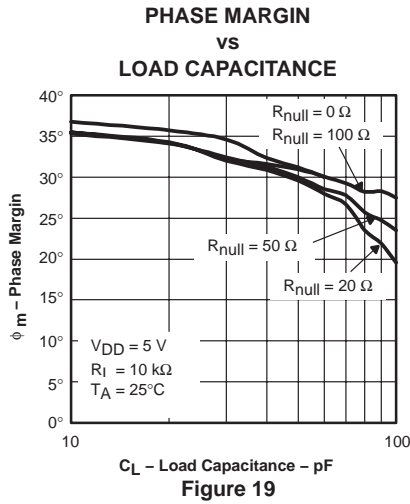
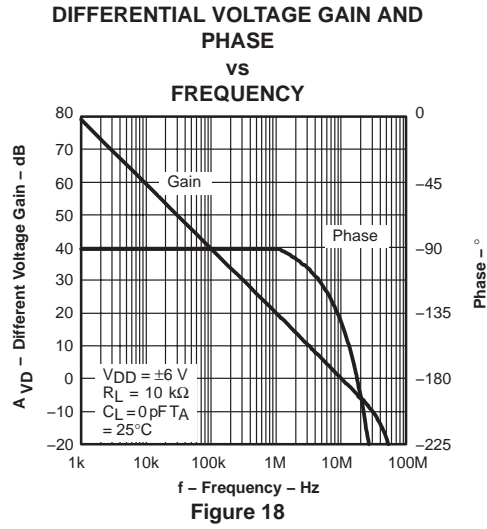
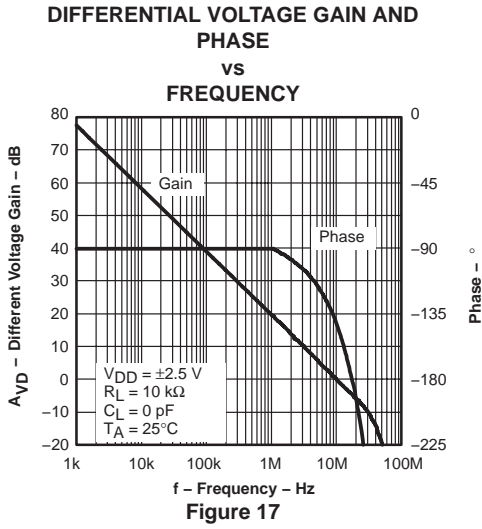

# TLC080, TLC081, TLC082, TLC083, TLC084, TLC085, TLC08xA FAMILY OF WIDE-BANDWIDTH HIGH-OUTPUT-DRIVE SINGLE SUPPLY OPERATIONAL AMPLIFIERS

SLOS254D – JUNE 1999 – REVISED FEBRUARY 2004

## TYPICAL CHARACTERISTICS

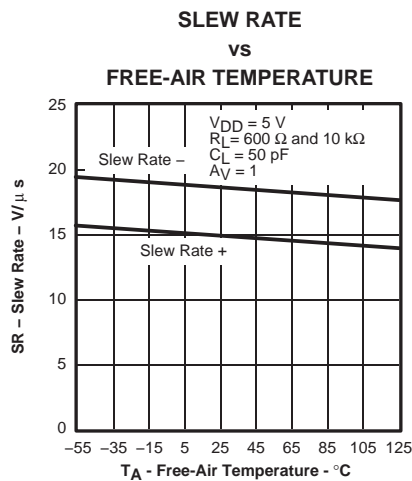

Figure 25

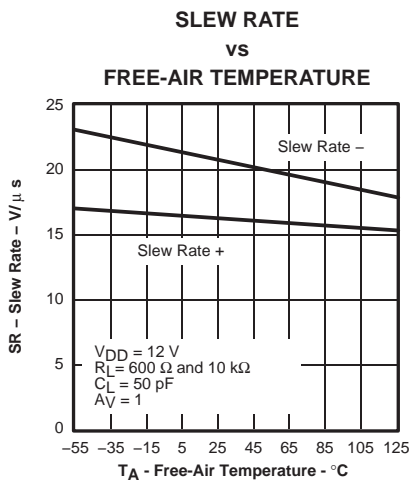

Figure 26

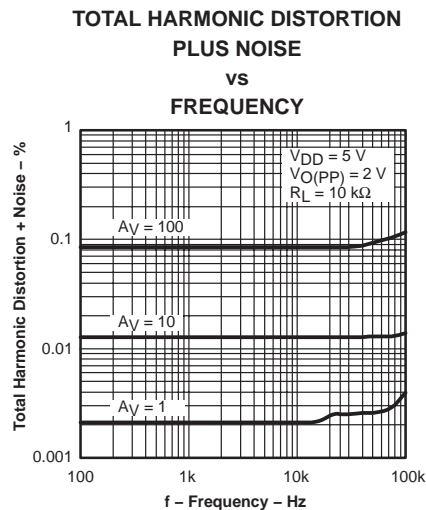

Figure 27

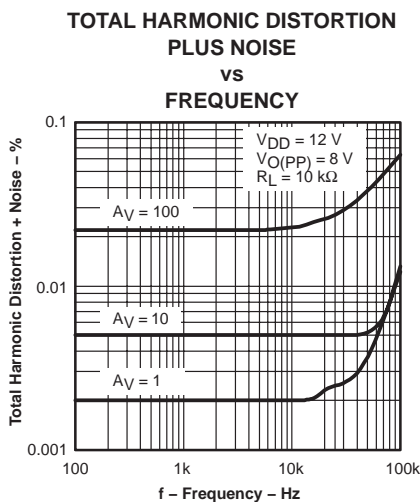

Figure 28

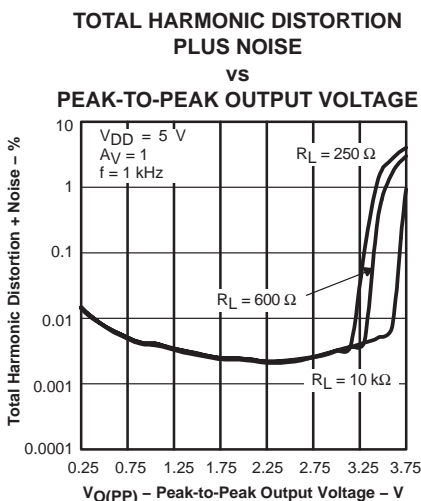

Figure 29

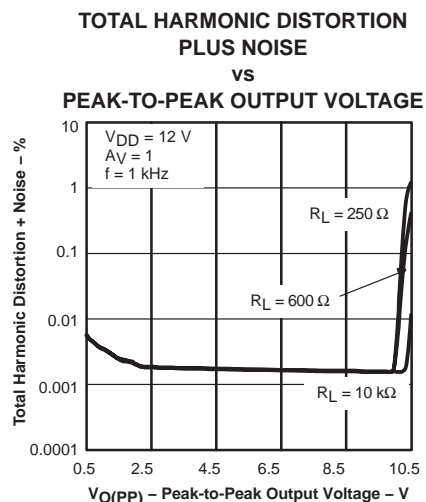

Figure 30

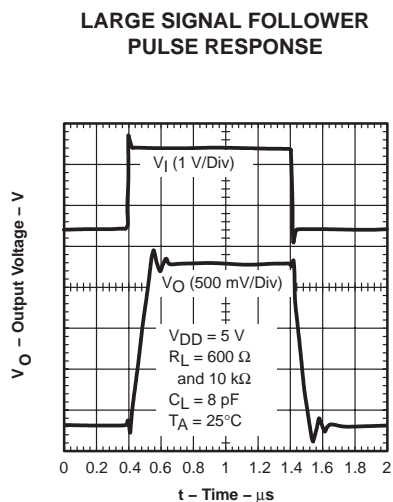

Figure 31

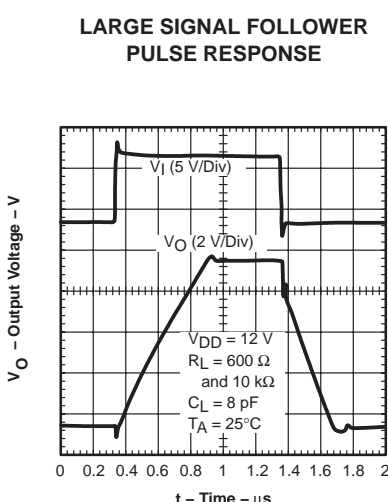

Figure 32

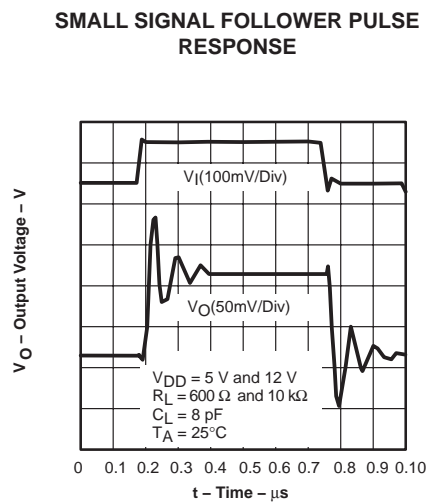

Figure 33

# TLC080, TLC081, TLC082, TLC083, TLC084, TLC085, TLC08xA FAMILY OF WIDE-BANDWIDTH HIGH-OUTPUT-DRIVE SINGLE SUPPLY OPERATIONAL AMPLIFIERS

SLOS254D – JUNE 1999 – REVISED FEBRUARY 2004

## TYPICAL CHARACTERISTICS

**LARGE SIGNAL INVERTING  
PULSE RESPONSE**

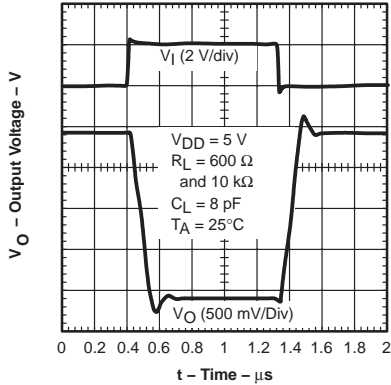

Figure 34

**LARGE SIGNAL INVERTING  
PULSE RESPONSE**

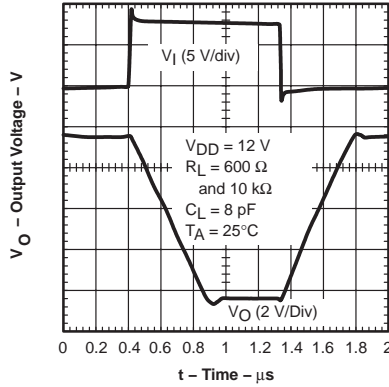

Figure 35

**SMALL SIGNAL INVERTING  
PULSE RESPONSE**

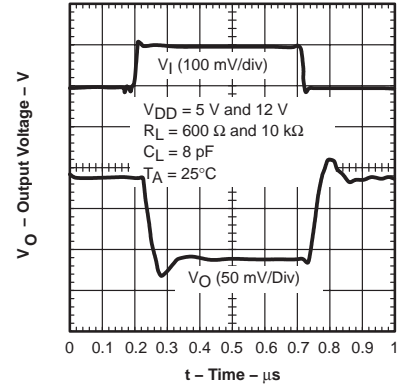

Figure 36

**SHUTDOWN FORWARD  
ISOLATION  
vs  
FREQUENCY**

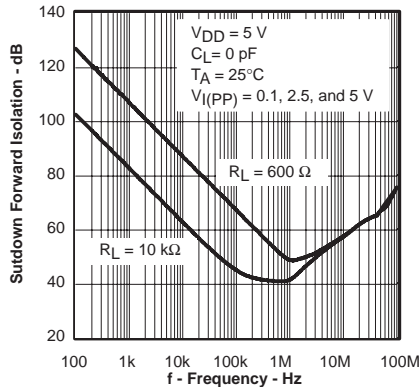

Figure 37

**SHUTDOWN FORWARD  
ISOLATION  
vs  
FREQUENCY**

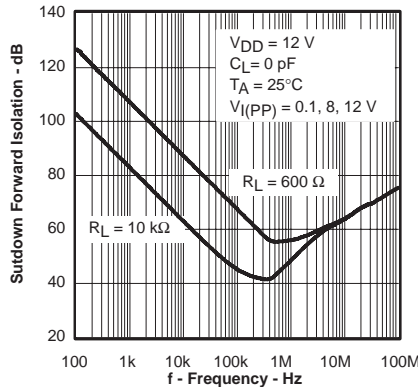

Figure 38

**SHUTDOWN REVERSE  
ISOLATION  
vs  
FREQUENCY**

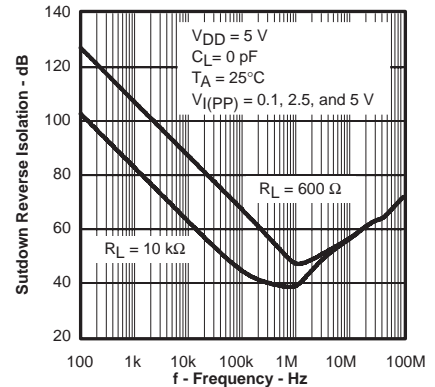

Figure 39

**SHUTDOWN REVERSE  
ISOLATION  
vs  
FREQUENCY**

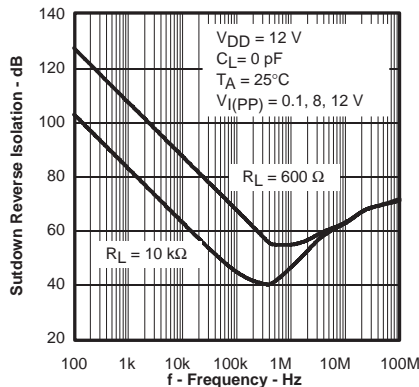

Figure 40

**SHUTDOWN SUPPLY CURRENT  
vs  
SUPPLY VOLTAGE**

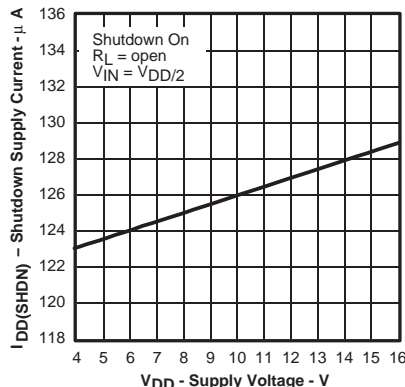

Figure 41

**SHUTDOWN SUPPLY CURRENT  
vs  
FREE-AIR TEMPERATURE**

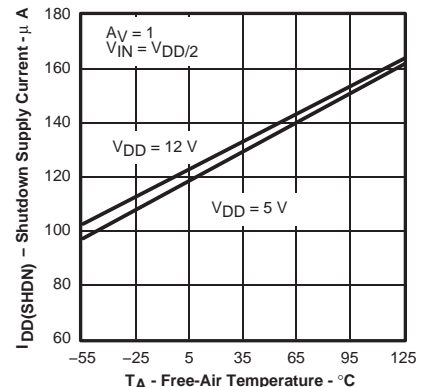

Figure 42



# TLC080, TLC081, TLC082, TLC083, TLC084, TLC085, TLC08xA FAMILY OF WIDE-BANDWIDTH HIGH-OUTPUT-DRIVE SINGLE SUPPLY OPERATIONAL AMPLIFIERS

SLOS254D – JUNE 1999 – REVISED FEBRUARY 2004

## TYPICAL CHARACTERISTICS

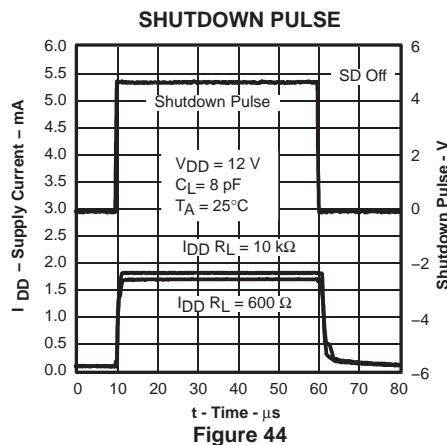
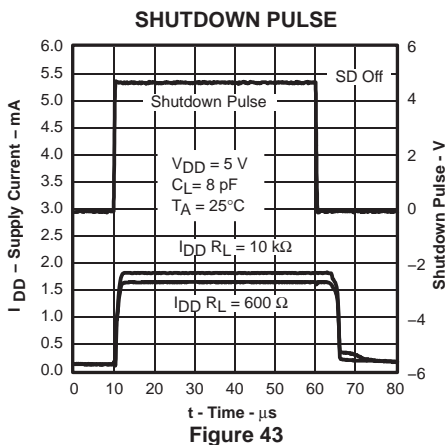

## PARAMETER MEASUREMENT INFORMATION

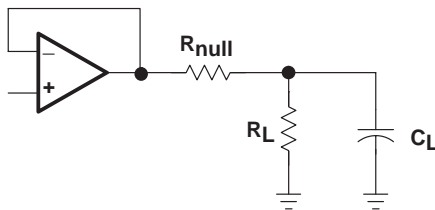
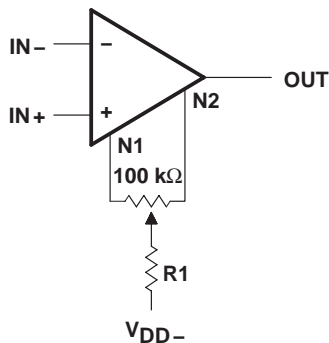

**Figure 45**

## APPLICATION INFORMATION

### input offset voltage null circuit

The TLC080 and TLC081 has an input offset nulling function. Refer to Figure 46 for the diagram.



NOTE A: R1 = 5.6 kΩ for offset voltage adjustment of  $\pm 10$  mV.  
R1 = 20 kΩ for offset voltage adjustment of  $\pm 3$  mV.

**Figure 46. Input Offset Voltage Null Circuit**

**APPLICATION INFORMATION**

**driving a capacitive load**

When the amplifier is configured in this manner, capacitive loading directly on the output will decrease the device’s phase margin leading to high frequency ringing or oscillations. Therefore, for capacitive loads of greater than 10 pF, it is recommended that a resistor be placed in series ( $R_{NULL}$ ) with the output of the amplifier, as shown in Figure 47. A minimum value of 20  $\Omega$  should work well for most applications.

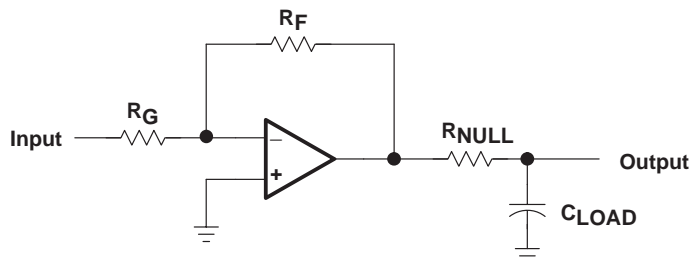

**Figure 47. Driving a Capacitive Load**

**offset voltage**

The output offset voltage, ( $V_{OO}$ ) is the sum of the input offset voltage ( $V_{IO}$ ) and both input bias currents ( $I_{IB}$ ) times the corresponding gains. The following schematic and formula can be used to calculate the output offset voltage:

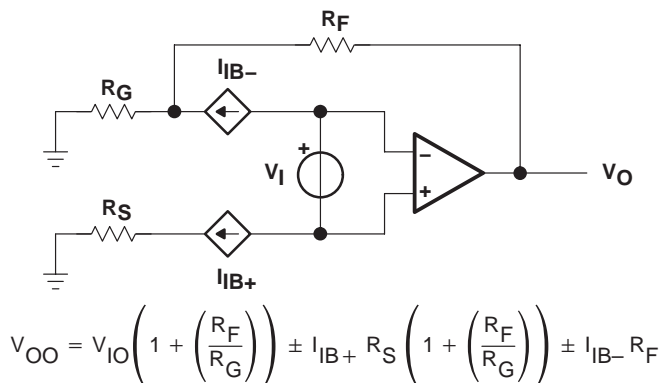

**Figure 48. Output Offset Voltage Model**

## APPLICATION INFORMATION

### high speed CMOS input amplifiers

The TLC08x is a family of high-speed low-noise CMOS input operational amplifiers that has an input capacitance of the order of 20 pF. Any resistor used in the feedback path adds a pole in the transfer function equivalent to the input capacitance multiplied by the combination of source resistance and feedback resistance. For example, a gain of  $-10$ , a source resistance of  $1\text{ k}\Omega$ , and a feedback resistance of  $10\text{ k}\Omega$  add an additional pole at approximately 8 MHz. This is more apparent with CMOS amplifiers than bipolar amplifiers due to their greater input capacitance.

This is of little consequence on slower CMOS amplifiers, as this pole normally occurs at frequencies above their unity-gain bandwidth. However, the TLC08x with its 10-MHz bandwidth means that this pole normally occurs at frequencies where there is on the order of 5dB gain left and the phase shift adds considerably.

The effect of this pole is the strongest with large feedback resistances at small closed loop gains. As the feedback resistance is increased, the gain peaking increases at a lower frequency and the  $180^\circ$  phase shift crossover point also moves down in frequency, decreasing the phase margin.

For the TLC08x, the maximum feedback resistor recommended is  $5\text{ k}\Omega$ ; larger resistances can be used but a capacitor in parallel with the feedback resistor is recommended to counter the effects of the input capacitance pole.

The TLC083 with a 1-V step response has an 80% overshoot with a natural frequency of 3.5 MHz when configured as a unity gain buffer and with a  $10\text{-k}\Omega$  feedback resistor. By adding a  $10\text{-pF}$  capacitor in parallel with the feedback resistor, the overshoot is reduced to 40% and eliminates the natural frequency, resulting in a much faster settling time (see Figure 49). The  $10\text{-pF}$  capacitor was chosen for convenience only.

Load capacitance had little effect on these measurements due to the excellent output drive capability of the TLC08x.

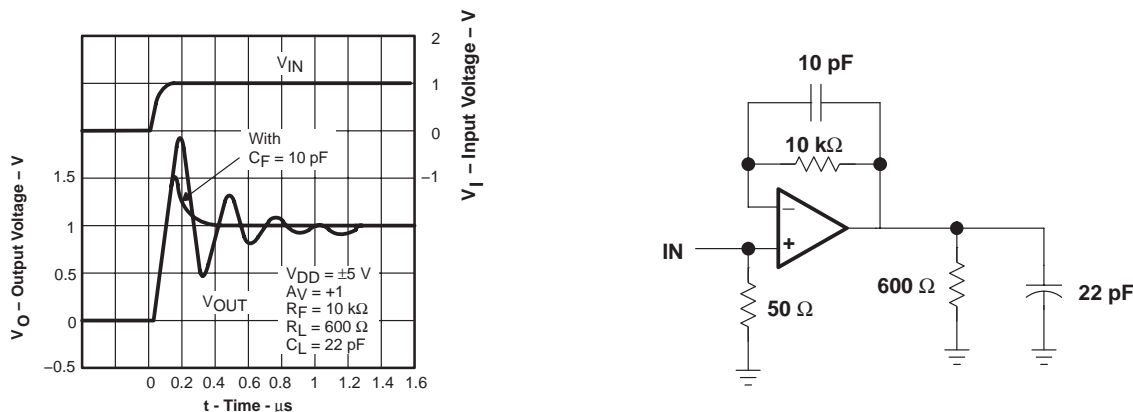
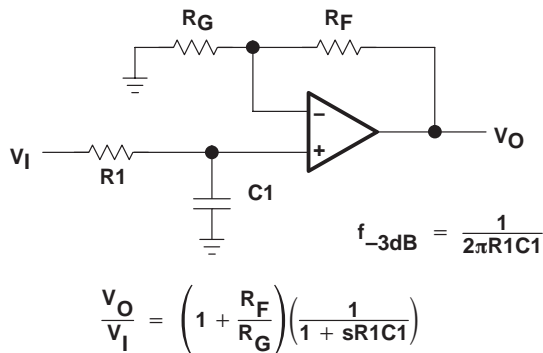

**Figure 49. 1-V Step Response**

**APPLICATION INFORMATION**

**general configurations**

When receiving low-level signals, limiting the bandwidth of the incoming signals into the system is often required. The simplest way to accomplish this is to place an RC filter at the noninverting terminal of the amplifier (see Figure 50).



**Figure 50. Single-Pole Low-Pass Filter**

If even more attenuation is needed, a multiple pole filter is required. The Sallen-Key filter can be used for this task. For best results, the amplifier should have a bandwidth that is 8 to 10 times the filter frequency bandwidth. Failure to do this can result in phase shift of the amplifier.

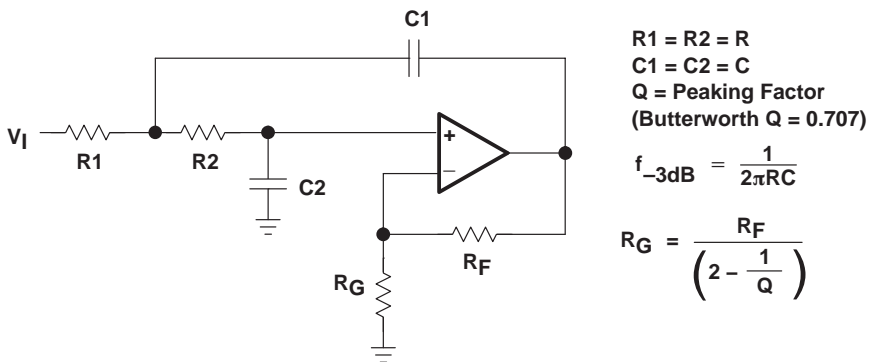

**Figure 51. 2-Pole Low-Pass Sallen-Key Filter**

---

## APPLICATION INFORMATION

### shutdown function

Three members of the TLC08x family (TLC080/3/5) have a shutdown terminal ( $\overline{\text{SHDN}}$ ) for conserving battery life in portable applications. When the shutdown terminal is tied low, the supply current is reduced to 125  $\mu\text{A}/\text{channel}$ , the amplifier is disabled, and the outputs are placed in a high-impedance mode. To enable the amplifier, the shutdown terminal can either be left floating or pulled high. When the shutdown terminal is left floating, care should be taken to ensure that parasitic leakage current at the shutdown terminal does not inadvertently place the operational amplifier into shutdown. The shutdown terminal threshold is always referenced to the voltage on the GND terminal of the device. Therefore, when operating the device with split supply voltages (e.g.  $\pm 2.5\text{ V}$ ), the shutdown terminal needs to be pulled to  $V_{\text{DD-}}$  (not system ground) to disable the operational amplifier.

The amplifier's output with a shutdown pulse is shown in Figures 43 and 44. The amplifier is powered with a single 5-V supply and is configured as noninverting with a gain of 5. The amplifier turnon and turnoff times are measured from the 50% point of the shutdown pulse to the 50% point of the output waveform. The times for the single, dual, and quad are listed in the data tables.

Figures 37, 38, 39, and 40 show the amplifier's forward and reverse isolation in shutdown. The operational amplifier is configured as a voltage follower ( $A_V = 1$ ). The isolation performance is plotted across frequency using 0.1  $V_{\text{PP}}$ , 2.5  $V_{\text{PP}}$ , and 5  $V_{\text{PP}}$  input signals at  $\pm 2.5\text{ V}$  supplies and 0.1  $V_{\text{PP}}$ , 8  $V_{\text{PP}}$ , and 12  $V_{\text{PP}}$  input signals at  $\pm 6\text{ V}$  supplies.

### circuit layout considerations

To achieve the levels of high performance of the TLC08x, follow proper printed-circuit board design techniques. A general set of guidelines is given in the following.

- Ground planes – It is highly recommended that a ground plane be used on the board to provide all components with a low inductive ground connection. However, in the areas of the amplifier inputs and output, the ground plane can be removed to minimize the stray capacitance.
- Proper power supply decoupling – Use a 6.8- $\mu\text{F}$  tantalum capacitor in parallel with a 0.1- $\mu\text{F}$  ceramic capacitor on each supply terminal. It may be possible to share the tantalum among several amplifiers depending on the application, but a 0.1- $\mu\text{F}$  ceramic capacitor should always be used on the supply terminal of every amplifier. In addition, the 0.1- $\mu\text{F}$  capacitor should be placed as close as possible to the supply terminal. As this distance increases, the inductance in the connecting trace makes the capacitor less effective. The designer should strive for distances of less than 0.1 inches between the device power terminals and the ceramic capacitors.
- Sockets – Sockets can be used but are not recommended. The additional lead inductance in the socket pins will often lead to stability problems. Surface-mount packages soldered directly to the printed-circuit board is the best implementation.
- Short trace runs/compact part placements – Optimum high performance is achieved when stray series inductance has been minimized. To realize this, the circuit layout should be made as compact as possible, thereby minimizing the length of all trace runs. Particular attention should be paid to the inverting input of the amplifier. Its length should be kept as short as possible. This will help to minimize stray capacitance at the input of the amplifier.
- Surface-mount passive components – Using surface-mount passive components is recommended for high performance amplifier circuits for several reasons. First, because of the extremely low lead inductance of surface-mount components, the problem with stray series inductance is greatly reduced. Second, the small size of surface-mount components naturally leads to a more compact layout thereby minimizing both stray inductance and capacitance. If leaded components are used, it is recommended that the lead lengths be kept as short as possible.

# TLC080, TLC081, TLC082, TLC083, TLC084, TLC085, TLC08xA FAMILY OF WIDE-BANDWIDTH HIGH-OUTPUT-DRIVE SINGLE SUPPLY OPERATIONAL AMPLIFIERS

SLOS254D – JUNE 1999 – REVISED FEBRUARY 2004

## APPLICATION INFORMATION

### general PowerPAD design considerations

The TLC08x is available in a thermally-enhanced PowerPAD family of packages. These packages are constructed using a downset leadframe upon which the die is mounted [see Figure 52(a) and Figure 52(b)]. This arrangement results in the lead frame being exposed as a thermal pad on the underside of the package [see Figure 52(c)]. Because this thermal pad has direct thermal contact with the die, excellent thermal performance can be achieved by providing a good thermal path away from the thermal pad.

The PowerPAD package allows for both assembly and thermal management in one manufacturing operation. During the surface-mount solder operation (when the leads are being soldered), the thermal pad can also be soldered to a copper area underneath the package. Through the use of thermal paths within this copper area, heat can be conducted away from the package into either a ground plane or other heat dissipating device.

The PowerPAD package represents a breakthrough in combining the small area and ease of assembly of surface mount with the, heretofore, awkward mechanical methods of heatsinking.

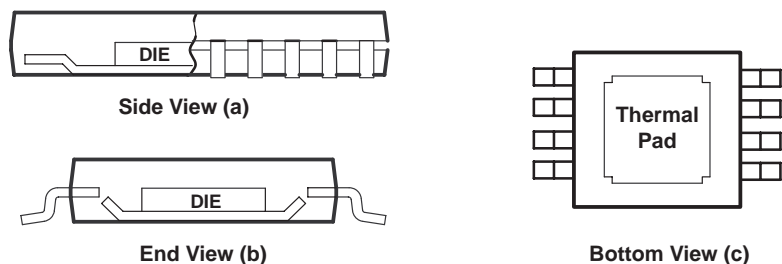

NOTE B: The thermal pad is electrically isolated from all terminals in the package.

**Figure 52. Views of Thermally Enhanced DGN Package**

Although there are many ways to properly heatsink the PowerPAD package, the following steps illustrate the recommended approach.

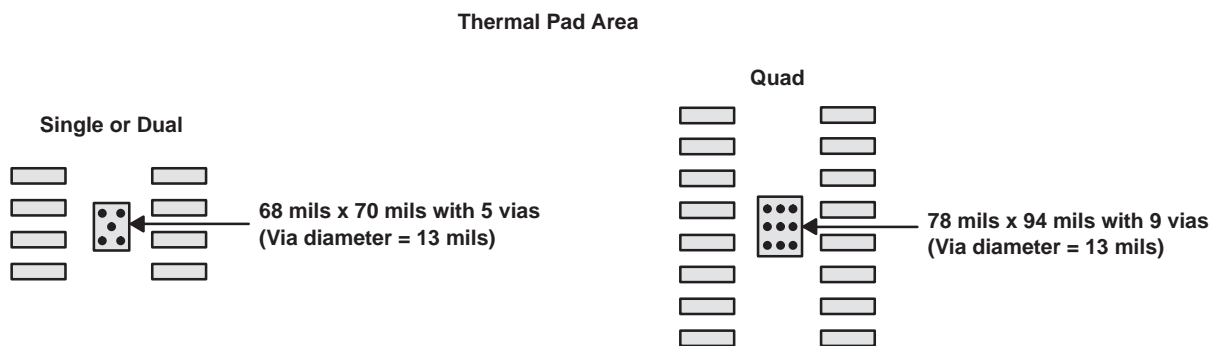

**Figure 53. PowerPAD PCB Etch and Via Pattern**

## APPLICATION INFORMATION

### general PowerPAD design considerations (continued)

1. Prepare the PCB with a top side etch pattern as shown in Figure 53. There should be etch for the leads as well as etch for the thermal pad.
2. Place five holes (dual) or nine holes (quad) in the area of the thermal pad. These holes should be 13 mils in diameter. Keep them small so that solder wicking through the holes is not a problem during reflow.
3. Additional vias may be placed anywhere along the thermal plane outside of the thermal pad area. This helps dissipate the heat generated by the TLC08x IC. These additional vias may be larger than the 13-mil diameter vias directly under the thermal pad. They can be larger because they are not in the thermal pad area to be soldered so that wicking is not a problem.
4. Connect all holes to the internal ground plane.
5. When connecting these holes to the ground plane, do not use the typical web or spoke via connection methodology. Web connections have a high thermal resistance connection that is useful for slowing the heat transfer during soldering operations. This makes the soldering of vias that have plane connections easier. In this application, however, low thermal resistance is desired for the most efficient heat transfer. Therefore, the holes under the TLC08x PowerPAD package should make their connection to the internal ground plane with a complete connection around the entire circumference of the plated-through hole.
6. The top-side solder mask should leave the terminals of the package and the thermal pad area with its five holes (dual) or nine holes (quad) exposed. The bottom-side solder mask should cover the five or nine holes of the thermal pad area. This prevents solder from being pulled away from the thermal pad area during the reflow process.
7. Apply solder paste to the exposed thermal pad area and all of the IC terminals.
8. With these preparatory steps in place, the TLC08x IC is simply placed in position and run through the solder reflow operation as any standard surface-mount component. This results in a part that is properly installed.

For a given  $\theta_{JA}$ , the maximum power dissipation is shown in Figure 54 and is calculated by the following formula:

$$P_D = \left( \frac{T_{MAX} - T_A}{\theta_{JA}} \right)$$

Where:

$P_D$  = Maximum power dissipation of TLC08x IC (watts)

$T_{MAX}$  = Absolute maximum junction temperature (150°C)

$T_A$  = Free-ambient air temperature (°C)

$\theta_{JA}$  =  $\theta_{JC} + \theta_{CA}$

$\theta_{JC}$  = Thermal coefficient from junction to case

$\theta_{CA}$  = Thermal coefficient from case to ambient air (°C/W)

**TLC080, TLC081, TLC082, TLC083, TLC084, TLC085, TLC08xA**  
**FAMILY OF WIDE-BANDWIDTH HIGH-OUTPUT-DRIVE SINGLE SUPPLY**  
**OPERATIONAL AMPLIFIERS**

SLOS254D – JUNE 1999 – REVISED FEBRUARY 2004

**APPLICATION INFORMATION**

**general PowerPAD design considerations (continued)**

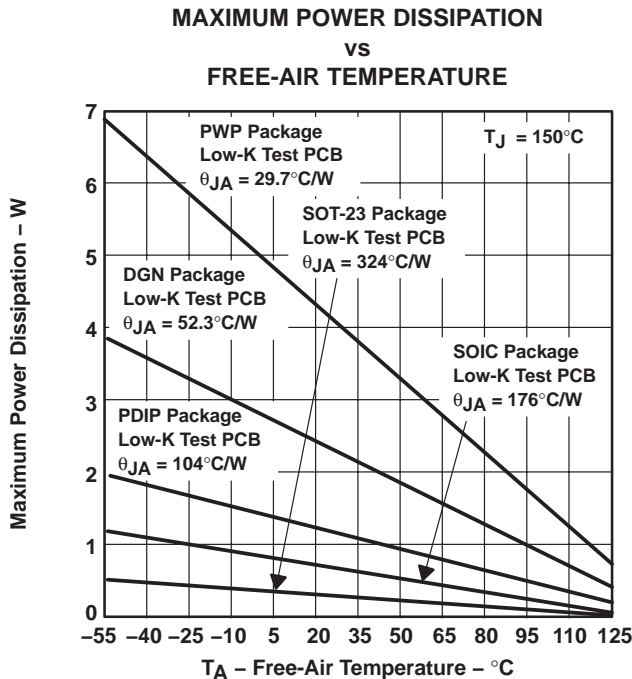

NOTE A: Results are with no air flow and using JEDEC Standard Low-K test PCB.

**Figure 54. Maximum Power Dissipation vs Free-Air Temperature**

The next consideration is the package constraints. The two sources of heat within an amplifier are quiescent power and output power. The designer should never forget about the quiescent heat generated within the device, especially multi-amplifier devices. Because these devices have linear output stages (Class A-B), most of the heat dissipation is at low output voltages with high output currents.

The other key factor when dealing with power dissipation is how the devices are mounted on the PCB. The PowerPAD devices are extremely useful for heat dissipation. But, the device should always be soldered to a copper plane to fully use the heat dissipation properties of the PowerPAD. The SOIC package, on the other hand, is highly dependent on how it is mounted on the PCB. As more trace and copper area is placed around the device,  $\theta_{JA}$  decreases and the heat dissipation capability increases. The currents and voltages shown in these graphs are for the total package. For the dual or quad amplifier packages, the sum of the RMS output currents and voltages should be used to choose the proper package.



# TLC080, TLC081, TLC082, TLC083, TLC084, TLC085, TLC08xA FAMILY OF WIDE-BANDWIDTH HIGH-OUTPUT-DRIVE SINGLE SUPPLY OPERATIONAL AMPLIFIERS

SLOS254D – JUNE 1999 – REVISED FEBRUARY 2004

## APPLICATION INFORMATION

### macromodel information

Macromodel information provided was derived using Microsim *Parts*<sup>™</sup>, the model generation software used with Microsim *PSPice*<sup>™</sup>. The Boyle macromodel (see Note 1) and subcircuit in Figure 55 are generated using the TLC08x typical electrical and operating characteristics at  $T_A = 25^\circ\text{C}$ . Using this information, output simulations of the following key parameters can be generated to a tolerance of 20% (in most cases):

- Maximum positive output voltage swing
- Maximum negative output voltage swing
- Slew rate
- Quiescent power dissipation
- Input bias current
- Open-loop voltage amplification
- Unity-gain frequency
- Common-mode rejection ratio
- Phase margin
- DC output resistance
- AC output resistance
- Short-circuit output current limit

NOTE 2: G. R. Boyle, B. M. Cohn, D. O. Pederson, and J. E. Solomon, "Macromodeling of Integrated Circuit Operational Amplifiers," *IEEE Journal of Solid-State Circuits*, SC-9, 353 (1974).

*PSPice* and *Parts* are trademarks of MicroSim Corporation.

# TLC080, TLC081, TLC082, TLC083, TLC084, TLC085, TLC08xA FAMILY OF WIDE-BANDWIDTH HIGH-OUTPUT-DRIVE SINGLE SUPPLY OPERATIONAL AMPLIFIERS

SLOS254D – JUNE 1999 – REVISED FEBRUARY 2004

## APPLICATION INFORMATION

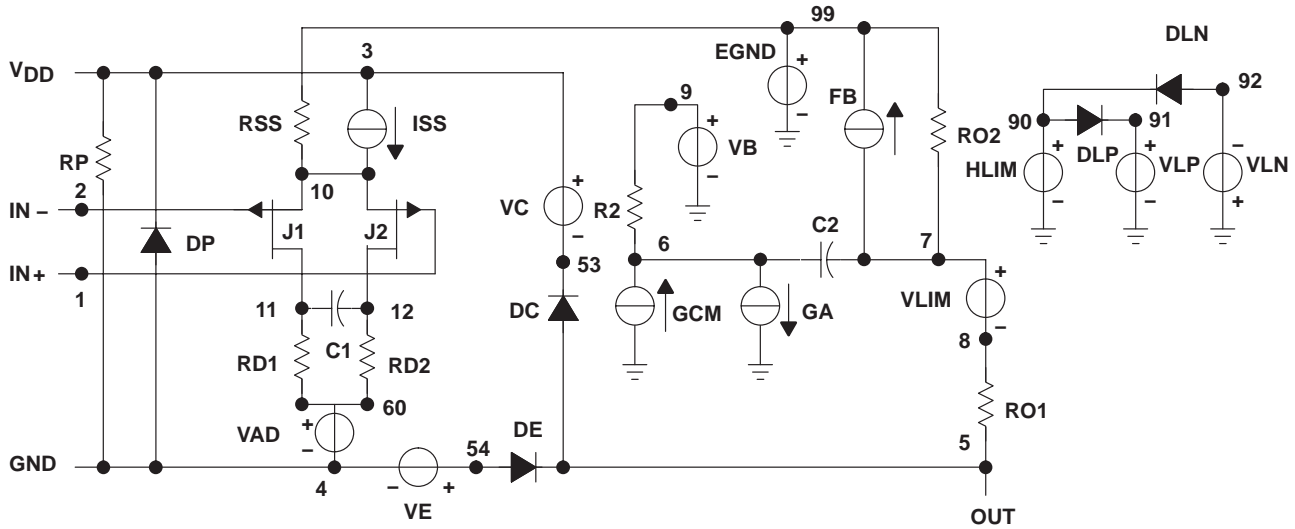

\*DEVICE=TLC08X\_5V, OPAMP, PJF, INT

\* TLC08X\_5V – 5V operational amplifier "macromodel" sub-circuit

\* created using Parts release 8.0 on 12/16/99 at 14:03

\* Parts is a MicroSim product.

\* connections:

	non-inverting input
	inverting input
	positive power supply
	negative power supply
	output

.subckt TLC08X\_5V 1 2 3 4 5

```

c1 11 12 4.6015E-12
c2 6 7 8.0000E-12
css 10 99 986.29E-15
dc 5 53 dy
de 54 5 dy
dlp 90 91 dx
dln 92 90 dx
dp 4 3 dx
egnd 99 0 poly(2) (3,0) (4,0) 0 .5 .5
fb 7 99 poly(5) vb vc ve vlp vln 0 13.984E6 -1E3 1E3
14E6 -14E6

```

```

ga 6 0 11 12 402.12E-6
gcm 0 6 10 99 1.5735E-6
ioff 0 6 dc 1.212E-6
iss 3 10 dc 130.40E-6
hlim 90 0 vlim 1K
j1 11 2 10 jx1
j2 12 1 10 jx2
r2 6 9 100.00E3
rd1 4 11 2.4868E3
rd2 4 12 2.4868E3
ro1 8 5 10
ro2 7 99 10
rp 3 4 2.8249E3
rss 10 99 1.5337E6
vb 9 0 dc 0
vc 3 53 dc 1.5537
ve 54 4 dc .84373
vlim 7 8 dc 0
vlp 91 0 dc 117.60
vln 0 92 dc 117.60
.model dx D(Is=800.00E-18)
.model dy D(Is=800.00E-18 Rs=1m Cjo=10p)
.model jx1 PJF(Is=80.000E-15 Beta=1.2401E-3 Vto=-1)
.model jx2 PJF(Is=80.000E-15 Beta=1.2401E-3 Vto=-1)
.ends

```

Figure 55. Boyle Macromodel and Subcircuit

TLC080, TLC081, TLC082, TLC083, TLC084, TLC085, TLC08xA  
FAMILY OF WIDE-BANDWIDTH HIGH-OUTPUT-DRIVE SINGLE SUPPLY  
OPERATIONAL AMPLIFIERS

SLOS254D – JUNE 1999 – REVISED FEBRUARY 2004

THERMAL PAD MECHANICAL DATA

DGQ (S-PDSO-G10)

PowerPAD™ PLASTIC SMALL-OUTLINE

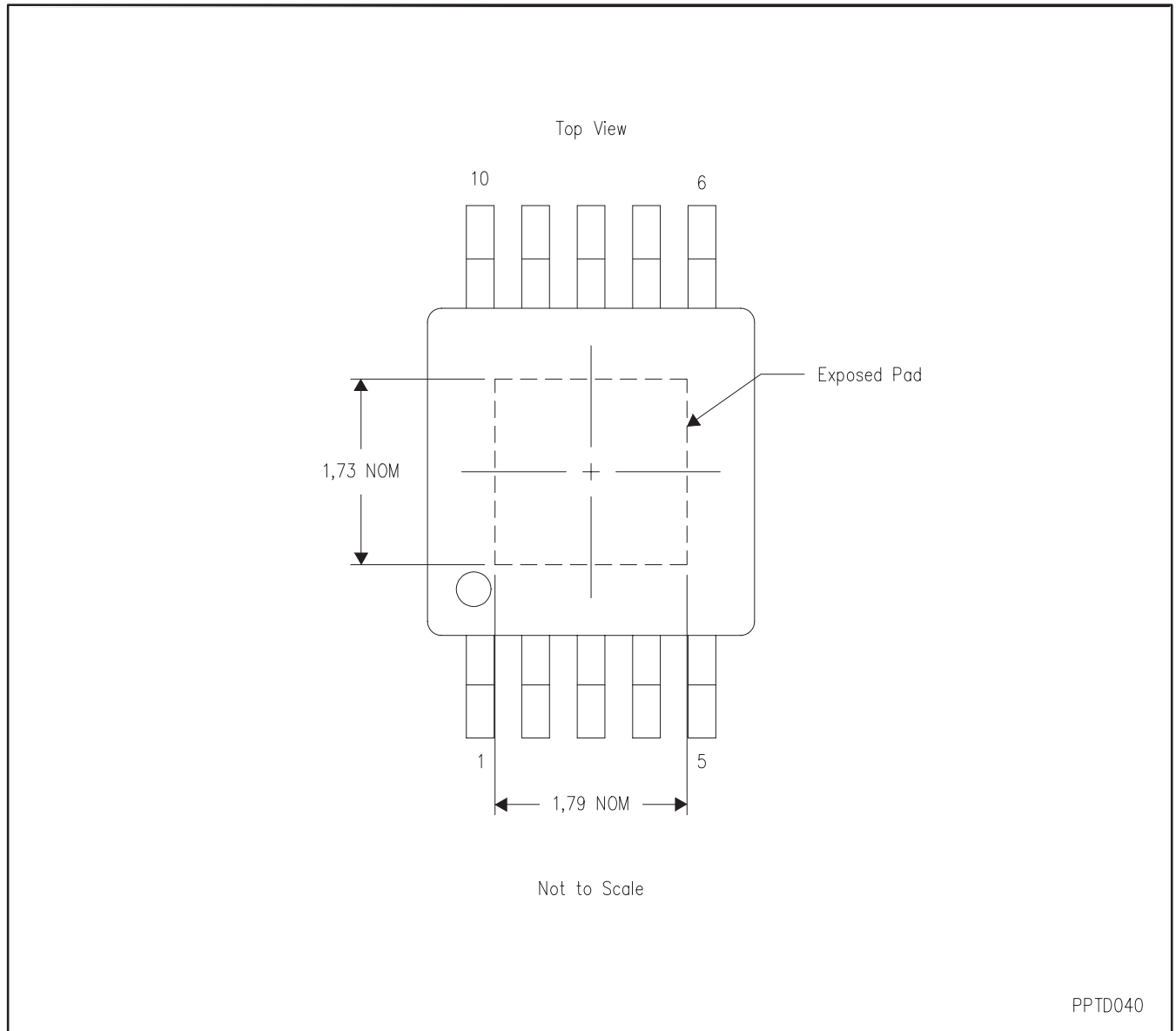

- NOTES:
- A. All linear dimensions are in millimeters.
  - B. This drawing is subject to change without notice.
  - C. For additional information on the PowerPAD™ package and how to take advantage of its heat dissipating abilities, refer to Technical Brief, **PowerPAD Thermally Enhanced Package**, Texas Instruments Literature No. SLMA002 and Application Brief, **PowerPAD Made Easy**, Texas Instruments Literature No. SLMA004. Both documents are available at [www.ti.com](http://www.ti.com).

PowerPAD is a trademark of Texas Instruments

# TLC080, TLC081, TLC082, TLC083, TLC084, TLC085, TLC08xA FAMILY OF WIDE-BANDWIDTH HIGH-OUTPUT-DRIVE SINGLE SUPPLY OPERATIONAL AMPLIFIERS

SLOS254D – JUNE 1999 – REVISED FEBRUARY 2004

## THERMAL PAD MECHANICAL DATA

DGN (S-PDSO-G8)

PowerPAD™ PLASTIC SMALL-OUTLINE

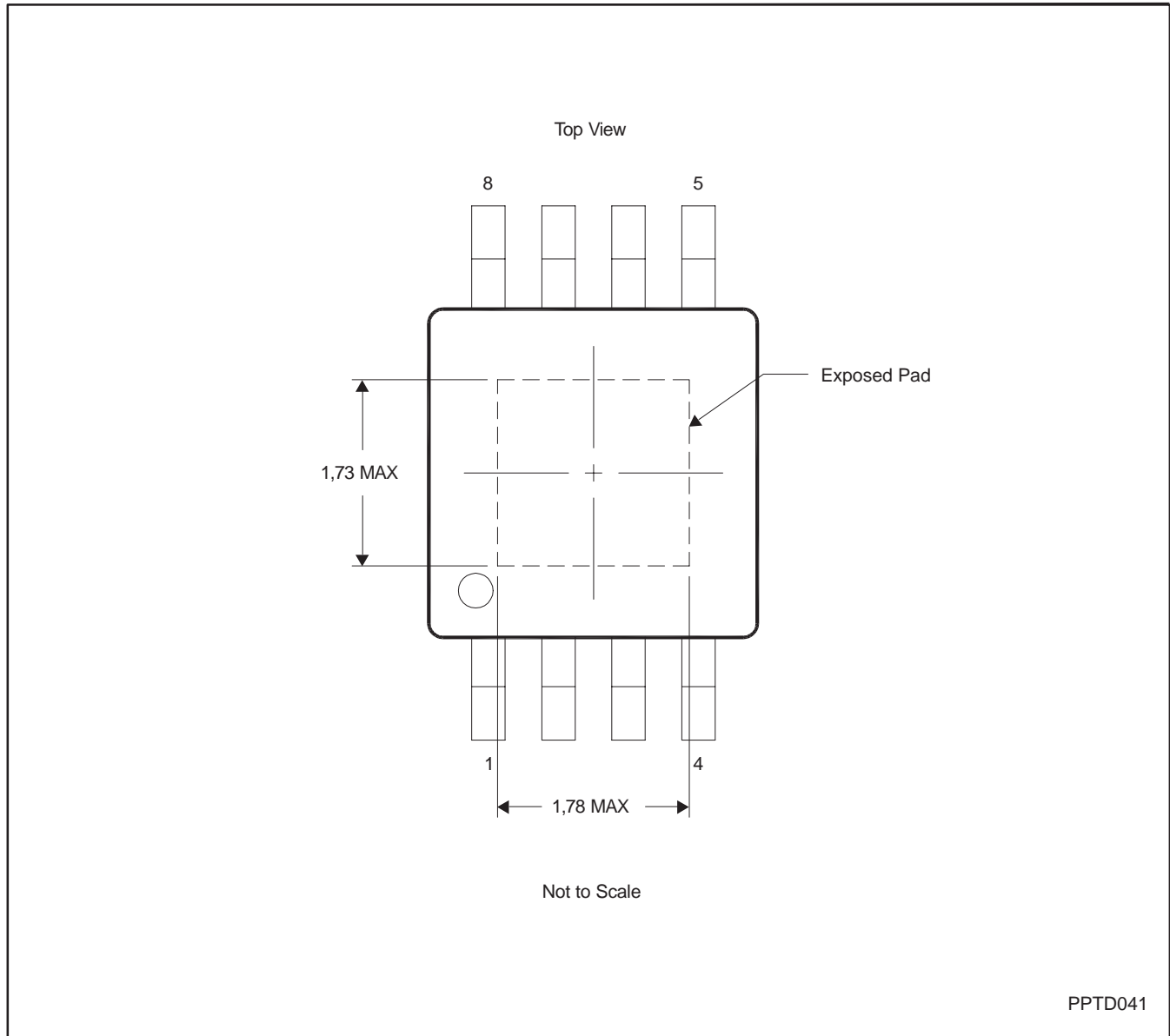

- NOTES:
- A. All linear dimensions are in millimeters.
  - B. This drawing is subject to change without notice.
  - C. For additional information on the PowerPAD™ package and how to take advantage of its heat dissipating abilities, refer to Technical Brief, *PowerPAD Thermally Enhanced Package*, Texas Instruments Literature No. SLMA002 and Application Brief, *PowerPAD Made Easy*, Texas Instruments Literature No. SLMA004. Both documents are available at [www.ti.com](http://www.ti.com).

PowerPAD is a trademark of Texas Instruments

TLC080, TLC081, TLC082, TLC083, TLC084, TLC085, TLC08xA  
FAMILY OF WIDE-BANDWIDTH HIGH-OUTPUT-DRIVE SINGLE SUPPLY  
OPERATIONAL AMPLIFIERS

SLOS254D – JUNE 1999 – REVISED FEBRUARY 2004

THERMAL PAD MECHANICAL DATA

PWP (R-PDSO-G14)

PowerPAD™ PLASTIC SMALL-OUTLINE

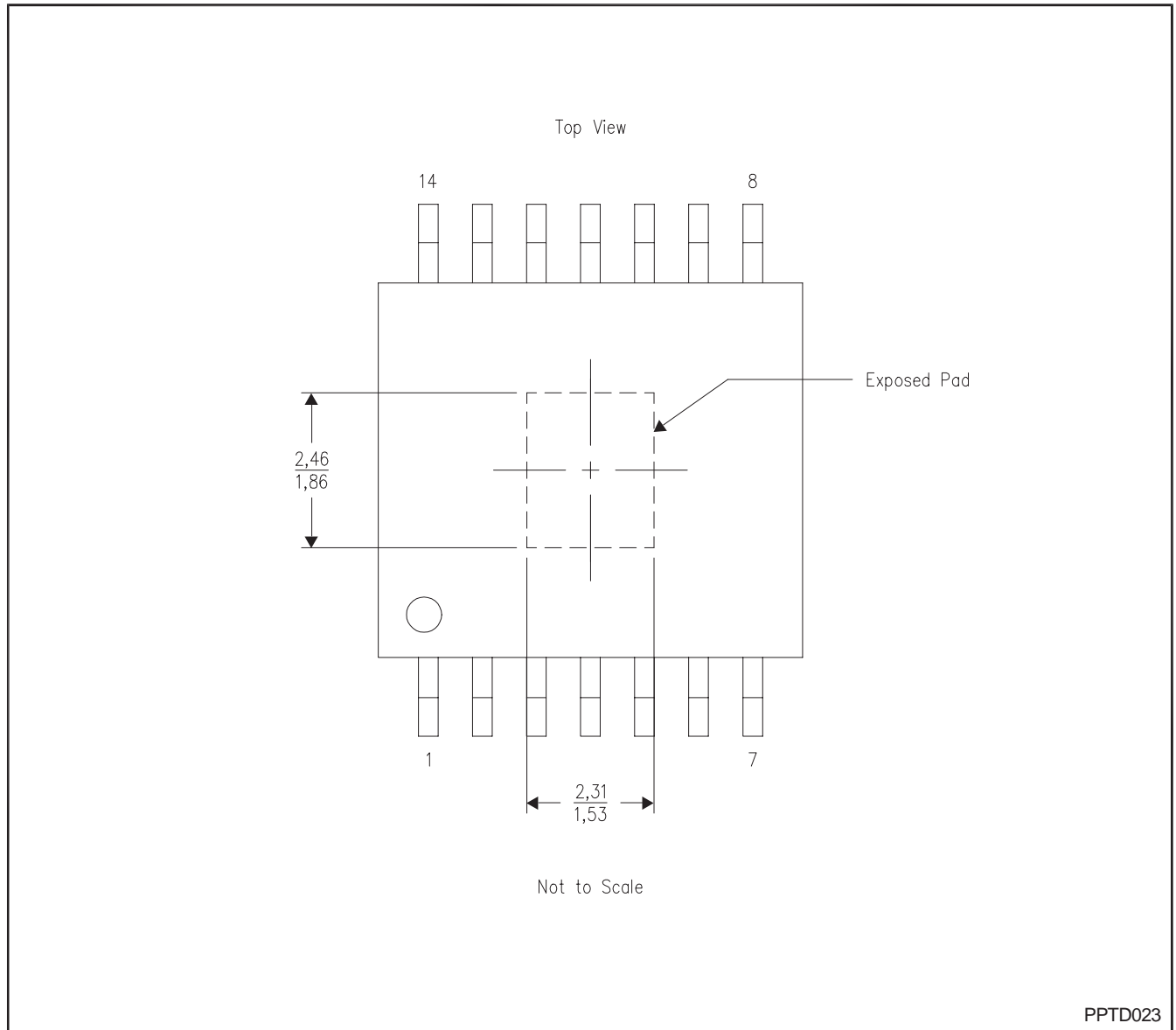

- NOTES:
- A. All linear dimensions are in millimeters.
  - B. This drawing is subject to change without notice.
  - C. For additional information on the PowerPAD™ package and how to take advantage of its heat dissipating abilities, refer to Technical Brief, **PowerPAD Thermally Enhanced Package**, Texas Instruments Literature No. SLMA002 and Application Brief, **PowerPAD Made Easy**, Texas Instruments Literature No. SLMA004. Both documents are available at [www.ti.com](http://www.ti.com).

PowerPAD is a trademark of Texas Instruments

# TLC080, TLC081, TLC082, TLC083, TLC084, TLC085, TLC08xA FAMILY OF WIDE-BANDWIDTH HIGH-OUTPUT-DRIVE SINGLE SUPPLY OPERATIONAL AMPLIFIERS

SLOS254D – JUNE 1999 – REVISED FEBRUARY 2004

## THERMAL PAD MECHANICAL DATA

PWP (R-PDSO-G16)

PowerPAD™ PLASTIC SMALL-OUTLINE

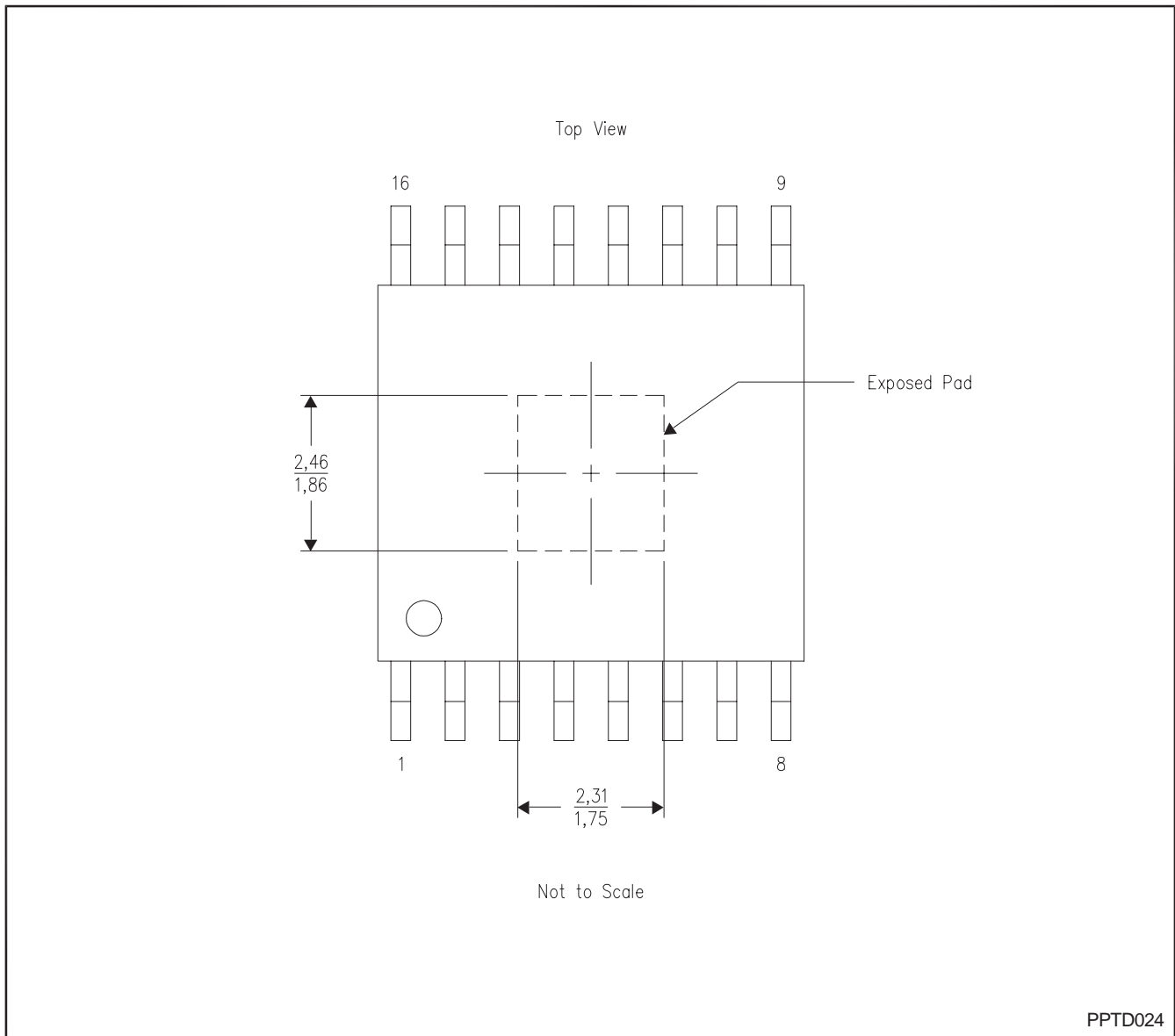

- NOTES:
- A. All linear dimensions are in millimeters.
  - B. This drawing is subject to change without notice.
  - C. For additional information on the PowerPAD™ package and how to take advantage of its heat dissipating abilities, refer to Technical Brief, **PowerPAD Thermally Enhanced Package**, Texas Instruments Literature No. SLMA002 and Application Brief, **PowerPAD Made Easy**, Texas Instruments Literature No. SLMA004. Both documents are available at [www.ti.com](http://www.ti.com).

PowerPAD is a trademark of Texas Instruments

PWP (R-PDSO-G\*\*) 20 PIN SHOWN

PowerPAD™ PLASTIC SMALL-OUTLINE PACKAGE

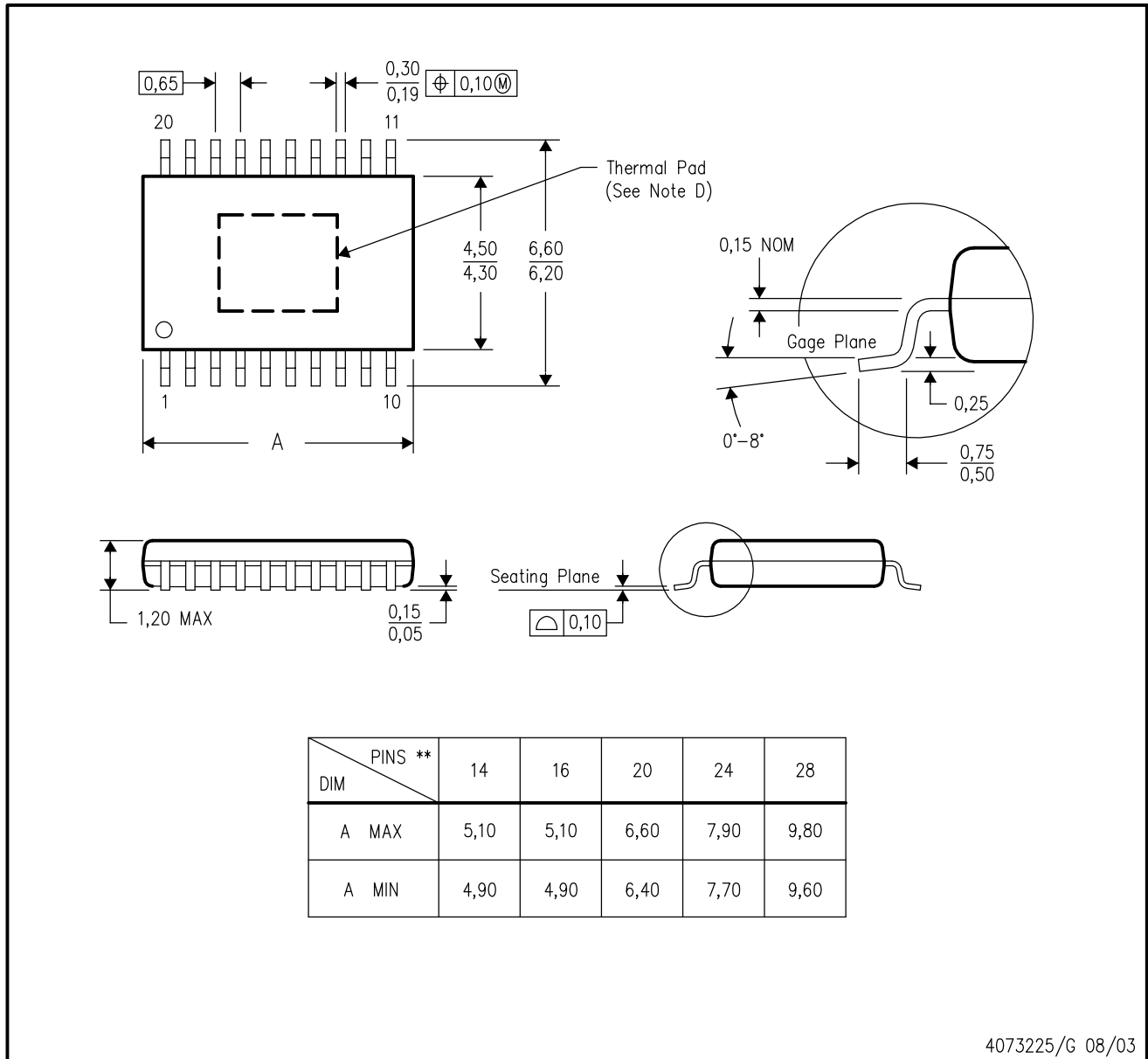

4073225/G 08/03

- NOTES:
- A. All linear dimensions are in millimeters.
  - B. This drawing is subject to change without notice.
  - C. Body dimensions do not include mold flash or protrusions.
  - D. This package is designed to be soldered to a thermal pad on the board. Refer to Technical Brief, PowerPad Thermally Enhanced Package, Texas Instruments Literature No. SLMA002 for information regarding recommended board layout. This document is available at [www.ti.com](http://www.ti.com) <<http://www.ti.com>>.
  - E. Falls within JEDEC MO-153

PowerPAD is a trademark of Texas Instruments.

P (R-PDIP-T8)

PLASTIC DUAL-IN-LINE



- NOTES: A. All linear dimensions are in inches (millimeters).  
 B. This drawing is subject to change without notice.  
 C. Falls within JEDEC MS-001

For the latest package information, go to [http://www.ti.com/sc/docs/package/pkg\\_info.htm](http://www.ti.com/sc/docs/package/pkg_info.htm)



N (R-PDIP-T\*\*)

PLASTIC DUAL-IN-LINE PACKAGE

16 PINS SHOWN



- NOTES:
- A. All linear dimensions are in inches (millimeters).
  - B. This drawing is subject to change without notice.
  - Falls within JEDEC MS-001, except 18 and 20 pin minimum body length (Dim A).
  - The 20 pin end lead shoulder width is a vendor option, either half or full width.

DGQ (S-PDSO-G10)

PowerPAD™ PLASTIC SMALL-OUTLINE PACKAGE

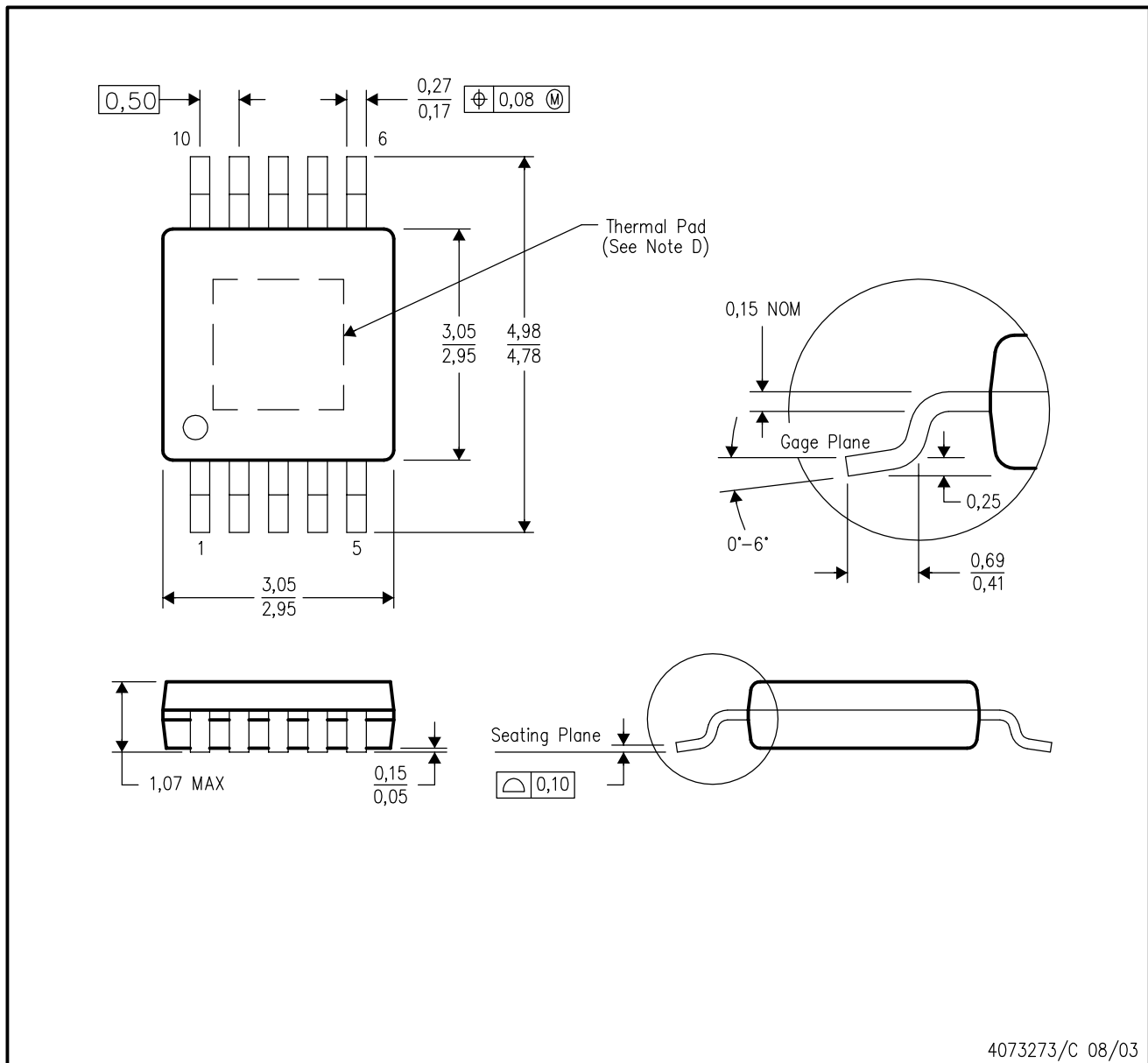

- NOTES:
- All linear dimensions are in millimeters.
  - This drawing is subject to change without notice.
  - Body dimensions do not include mold flash or protrusion.
  - This package is designed to be soldered to a thermal pad on the board. Refer to Technical Brief, PowerPAD Thermally Enhanced Package, Texas Instruments Literature No. SLMA002 for information regarding recommended board layout. This document is available at [www.ti.com](http://www.ti.com) <<http://www.ti.com>>.
  - Falls within JEDEC MO-187.

PowerPAD is a trademark of Texas Instruments.

DGN (S-PDSO-G8)

PowerPAD™ PLASTIC SMALL-OUTLINE PACKAGE

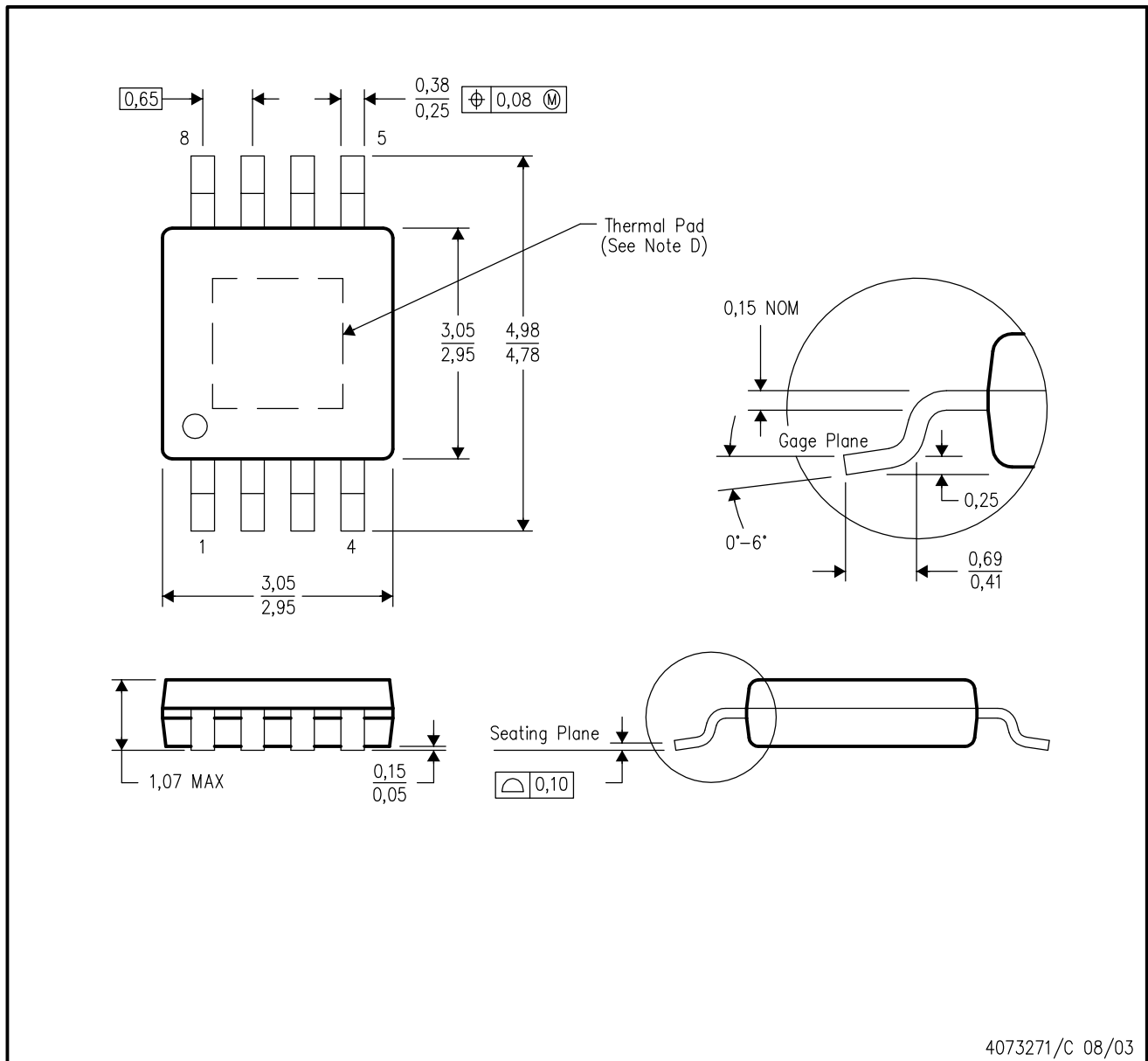

4073271/C 08/03

- NOTES:
- All linear dimensions are in millimeters.
  - This drawing is subject to change without notice.
  - Body dimensions do not include mold flash or protrusion.
  - This package is designed to be soldered to a thermal pad on the board. Refer to Technical Brief, PowerPad Thermally Enhanced Package, Texas Instruments Literature No. SLMA002 for information regarding recommended board layout. This document is available at [www.ti.com](http://www.ti.com) <<http://www.ti.com>>.
  - Falls within JEDEC MO-187

PowerPAD is a trademark of Texas Instruments.

D (R-PDSO-G\*\*)

PLASTIC SMALL-OUTLINE PACKAGE

8 PINS SHOWN



- NOTES: A. All linear dimensions are in inches (millimeters).  
 B. This drawing is subject to change without notice.  
 C. Body dimensions do not include mold flash or protrusion, not to exceed 0.006 (0,15).  
 D. Falls within JEDEC MS-012

**PACKAGING INFORMATION**

Orderable Device	Status <sup>(1)</sup>	Package Type	Package Drawing	Pins	Package Qty	Eco Plan <sup>(2)</sup>	Lead/Ball Finish	MSL Peak Temp <sup>(3)</sup>
TLC080AID	ACTIVE	SOIC	D	8	75	Green (RoHS & no Sb/Br)	CU NIPDAU	Level-1-260C-UNLIM
TLC080AIDG4	ACTIVE	SOIC	D	8	75	Green (RoHS & no Sb/Br)	CU NIPDAU	Level-1-260C-UNLIM
TLC080AIDR	ACTIVE	SOIC	D	8	2500	Green (RoHS & no Sb/Br)	CU NIPDAU	Level-1-260C-UNLIM
TLC080AIP	ACTIVE	PDIP	P	8	50	Pb-Free (RoHS)	CU NIPDAU	Level-NC-NC-NC
TLC080AIPe4	ACTIVE	PDIP	P	8	50	Pb-Free (RoHS)	CU NIPDAU	Level-NC-NC-NC
TLC080CD	ACTIVE	SOIC	D	8	75	Green (RoHS & no Sb/Br)	CU NIPDAU	Level-1-260C-UNLIM
TLC080CDGN	ACTIVE	MSOP-Power PAD	DGN	8	80	Green (RoHS & no Sb/Br)	CU NIPDAU	Level-1-260C-UNLIM
TLC080CDGNG4	ACTIVE	MSOP-Power PAD	DGN	8	80	Green (RoHS & no Sb/Br)	CU NIPDAU	Level-1-260C-UNLIM
TLC080CDGNR	ACTIVE	MSOP-Power PAD	DGN	8	2500	Green (RoHS & no Sb/Br)	CU NIPDAU	Level-1-260C-UNLIM
TLC080CDGNRG4	ACTIVE	MSOP-Power PAD	DGN	8	2500	Green (RoHS & no Sb/Br)	CU NIPDAU	Level-1-260C-UNLIM
TLC080CDR	ACTIVE	SOIC	D	8	2500	Green (RoHS & no Sb/Br)	CU NIPDAU	Level-1-260C-UNLIM
TLC080CDRG4	ACTIVE	SOIC	D	8	2500	Green (RoHS & no Sb/Br)	CU NIPDAU	Level-1-260C-UNLIM
TLC080CP	ACTIVE	PDIP	P	8	50	Pb-Free (RoHS)	CU NIPDAU	Level-NC-NC-NC
TLC080CPE4	ACTIVE	PDIP	P	8	50	Pb-Free (RoHS)	CU NIPDAU	Level-NC-NC-NC
TLC080ID	ACTIVE	SOIC	D	8	75	Green (RoHS & no Sb/Br)	CU NIPDAU	Level-1-260C-UNLIM
TLC080IDGN	ACTIVE	MSOP-Power PAD	DGN	8	80	Green (RoHS & no Sb/Br)	CU NIPDAU	Level-1-260C-UNLIM
TLC080IDGNG4	ACTIVE	MSOP-Power PAD	DGN	8	80	Green (RoHS & no Sb/Br)	CU NIPDAU	Level-1-260C-UNLIM
TLC080IDGNR	ACTIVE	MSOP-Power PAD	DGN	8	2500	Green (RoHS & no Sb/Br)	CU NIPDAU	Level-1-260C-UNLIM
TLC080IDGNRG4	ACTIVE	MSOP-Power PAD	DGN	8	2500	Green (RoHS & no Sb/Br)	CU NIPDAU	Level-1-260C-UNLIM
TLC080IDR	ACTIVE	SOIC	D	8	2500	Green (RoHS & no Sb/Br)	CU NIPDAU	Level-1-260C-UNLIM
TLC080IDRG4	ACTIVE	SOIC	D	8	2500	Green (RoHS & no Sb/Br)	CU NIPDAU	Level-1-260C-UNLIM
TLC080IP	ACTIVE	PDIP	P	8	50	Pb-Free	CU NIPDAU	Level-NC-NC-NC

Orderable Device	Status <sup>(1)</sup>	Package Type	Package Drawing	Pins	Package Qty	Eco Plan <sup>(2)</sup>	Lead/Ball Finish	MSL Peak Temp <sup>(3)</sup>
						(RoHS)		
TLC080IPE4	ACTIVE	PDIP	P	8	50	Pb-Free (RoHS)	CU NIPDAU	Level-NC-NC-NC
TLC081AID	ACTIVE	SOIC	D	8	75	Green (RoHS & no Sb/Br)	CU NIPDAU	Level-1-260C-UNLIM
TLC081AIDR	ACTIVE	SOIC	D	8	2500	Green (RoHS & no Sb/Br)	CU NIPDAU	Level-1-260C-UNLIM
TLC081AIDRG4	ACTIVE	SOIC	D	8	2500	Green (RoHS & no Sb/Br)	CU NIPDAU	Level-1-260C-UNLIM
TLC081AIP	ACTIVE	PDIP	P	8	50	Pb-Free (RoHS)	CU NIPDAU	Level-NC-NC-NC
TLC081AIPE4	ACTIVE	PDIP	P	8	50	Pb-Free (RoHS)	CU NIPDAU	Level-NC-NC-NC
TLC081CD	ACTIVE	SOIC	D	8	75	Green (RoHS & no Sb/Br)	CU NIPDAU	Level-1-260C-UNLIM
TLC081CDG4	ACTIVE	SOIC	D	8	75	Green (RoHS & no Sb/Br)	CU NIPDAU	Level-1-260C-UNLIM
TLC081CDGN	ACTIVE	MSOP-Power PAD	DGN	8	80	Green (RoHS & no Sb/Br)	CU NIPDAU	Level-1-260C-UNLIM
TLC081CDGNG4	ACTIVE	MSOP-Power PAD	DGN	8	80	Green (RoHS & no Sb/Br)	CU NIPDAU	Level-1-260C-UNLIM
TLC081CDGNR	ACTIVE	MSOP-Power PAD	DGN	8	2500	Green (RoHS & no Sb/Br)	CU NIPDAU	Level-1-260C-UNLIM
TLC081CDR	ACTIVE	SOIC	D	8	2500	Green (RoHS & no Sb/Br)	CU NIPDAU	Level-1-260C-UNLIM
TLC081CDRG4	ACTIVE	SOIC	D	8	2500	Green (RoHS & no Sb/Br)	CU NIPDAU	Level-1-260C-UNLIM
TLC081CP	ACTIVE	PDIP	P	8	50	Pb-Free (RoHS)	CU NIPDAU	Level-NC-NC-NC
TLC081CPE4	ACTIVE	PDIP	P	8	50	Pb-Free (RoHS)	CU NIPDAU	Level-NC-NC-NC
TLC081ID	ACTIVE	SOIC	D	8	75	Green (RoHS & no Sb/Br)	CU NIPDAU	Level-1-260C-UNLIM
TLC081IDG4	ACTIVE	SOIC	D	8	75	Green (RoHS & no Sb/Br)	CU NIPDAU	Level-1-260C-UNLIM
TLC081IDGN	ACTIVE	MSOP-Power PAD	DGN	8	80	Green (RoHS & no Sb/Br)	CU NIPDAU	Level-1-260C-UNLIM
TLC081IDGNR	ACTIVE	MSOP-Power PAD	DGN	8	2500	Green (RoHS & no Sb/Br)	CU NIPDAU	Level-1-260C-UNLIM
TLC081IDGNRG4	ACTIVE	MSOP-Power PAD	DGN	8	2500	Green (RoHS & no Sb/Br)	CU NIPDAU	Level-1-260C-UNLIM
TLC081IDR	ACTIVE	SOIC	D	8	2500	Green (RoHS & no Sb/Br)	CU NIPDAU	Level-1-260C-UNLIM
TLC081IDRG4	ACTIVE	SOIC	D	8	2500	Green (RoHS & no Sb/Br)	CU NIPDAU	Level-1-260C-UNLIM
TLC081IP	ACTIVE	PDIP	P	8	50	Pb-Free	CU NIPDAU	Level-NC-NC-NC

Orderable Device	Status <sup>(1)</sup>	Package Type	Package Drawing	Pins	Package Qty	Eco Plan <sup>(2)</sup>	Lead/Ball Finish	MSL Peak Temp <sup>(3)</sup>
						(RoHS)		
TLC081IPE4	ACTIVE	PDIP	P	8	50	Pb-Free (RoHS)	CU NIPDAU	Level-NC-NC-NC
TLC082AID	ACTIVE	SOIC	D	8	75	Green (RoHS & no Sb/Br)	CU NIPDAU	Level-1-260C-UNLIM
TLC082AIDR	ACTIVE	SOIC	D	8	2500	Green (RoHS & no Sb/Br)	CU NIPDAU	Level-1-260C-UNLIM
TLC082AIDRG4	ACTIVE	SOIC	D	8	2500	Green (RoHS & no Sb/Br)	CU NIPDAU	Level-1-260C-UNLIM
TLC082AIP	ACTIVE	PDIP	P	8	50	Pb-Free (RoHS)	CU NIPDAU	Level-NC-NC-NC
TLC082AIPE4	ACTIVE	PDIP	P	8	50	Pb-Free (RoHS)	CU NIPDAU	Level-NC-NC-NC
TLC082CD	ACTIVE	SOIC	D	8	75	Green (RoHS & no Sb/Br)	CU NIPDAU	Level-1-260C-UNLIM
TLC082CDG4	ACTIVE	SOIC	D	8	75	Green (RoHS & no Sb/Br)	CU NIPDAU	Level-1-260C-UNLIM
TLC082CDGN	ACTIVE	MSOP-Power PAD	DGN	8	80	Green (RoHS & no Sb/Br)	CU NIPDAU	Level-1-260C-UNLIM
TLC082CDGNR	ACTIVE	MSOP-Power PAD	DGN	8	2500	Green (RoHS & no Sb/Br)	CU NIPDAU	Level-1-260C-UNLIM
TLC082CDGNRG4	ACTIVE	MSOP-Power PAD	DGN	8	2500	Green (RoHS & no Sb/Br)	CU NIPDAU	Level-1-260C-UNLIM
TLC082CDR	ACTIVE	SOIC	D	8	2500	Green (RoHS & no Sb/Br)	CU NIPDAU	Level-1-260C-UNLIM
TLC082CDRG4	ACTIVE	SOIC	D	8	2500	Green (RoHS & no Sb/Br)	CU NIPDAU	Level-1-260C-UNLIM
TLC082CP	ACTIVE	PDIP	P	8	50	Pb-Free (RoHS)	CU NIPDAU	Level-NC-NC-NC
TLC082CPE4	ACTIVE	PDIP	P	8	50	Pb-Free (RoHS)	CU NIPDAU	Level-NC-NC-NC
TLC082ID	ACTIVE	SOIC	D	8	75	Green (RoHS & no Sb/Br)	CU NIPDAU	Level-1-260C-UNLIM
TLC082IDGN	ACTIVE	MSOP-Power PAD	DGN	8	80	Green (RoHS & no Sb/Br)	CU NIPDAU	Level-1-260C-UNLIM
TLC082IDGNR	ACTIVE	MSOP-Power PAD	DGN	8	2500	Green (RoHS & no Sb/Br)	CU NIPDAU	Level-1-260C-UNLIM
TLC082IDGNRG4	ACTIVE	MSOP-Power PAD	DGN	8	2500	Green (RoHS & no Sb/Br)	CU NIPDAU	Level-1-260C-UNLIM
TLC082IDR	ACTIVE	SOIC	D	8	2500	Green (RoHS & no Sb/Br)	CU NIPDAU	Level-1-260C-UNLIM
TLC082IDRG4	ACTIVE	SOIC	D	8	2500	Green (RoHS & no Sb/Br)	CU NIPDAU	Level-1-260C-UNLIM
TLC082IP	ACTIVE	PDIP	P	8	50	Pb-Free (RoHS)	CU NIPDAU	Level-NC-NC-NC
TLC082IPE4	ACTIVE	PDIP	P	8	50	Pb-Free	CU NIPDAU	Level-NC-NC-NC

Orderable Device	Status <sup>(1)</sup>	Package Type	Package Drawing	Pins	Package Qty	Eco Plan <sup>(2)</sup>	Lead/Ball Finish	MSL Peak Temp <sup>(3)</sup>
(RoHS)								
TLC083AID	ACTIVE	SOIC	D	14	50	Green (RoHS & no Sb/Br)	CU NIPDAU	Level-1-260C-UNLIM
TLC083AIDR	ACTIVE	SOIC	D	14	2500	Green (RoHS & no Sb/Br)	CU NIPDAU	Level-1-260C-UNLIM
TLC083AIDRG4	ACTIVE	SOIC	D	14	2500	Green (RoHS & no Sb/Br)	CU NIPDAU	Level-1-260C-UNLIM
TLC083AIN	ACTIVE	PDIP	N	14	25	Pb-Free (RoHS)	CU NIPDAU	Level-NC-NC-NC
TLC083AINE4	ACTIVE	PDIP	N	14	25	Pb-Free (RoHS)	CU NIPDAU	Level-NC-NC-NC
TLC083CD	ACTIVE	SOIC	D	14	50	Green (RoHS & no Sb/Br)	CU NIPDAU	Level-1-260C-UNLIM
TLC083CDGQ	ACTIVE	MSOP-Power PAD	DGQ	10	80	Green (RoHS & no Sb/Br)	CU NIPDAU	Level-1-260C-UNLIM
TLC083CDGQG4	ACTIVE	MSOP-Power PAD	DGQ	10	80	Green (RoHS & no Sb/Br)	CU NIPDAU	Level-1-260C-UNLIM
TLC083CDGQR	ACTIVE	MSOP-Power PAD	DGQ	10	2500	Green (RoHS & no Sb/Br)	CU NIPDAU	Level-1-260C-UNLIM
TLC083CDGQRG4	ACTIVE	MSOP-Power PAD	DGQ	10	2500	Green (RoHS & no Sb/Br)	CU NIPDAU	Level-1-260C-UNLIM
TLC083CDR	ACTIVE	SOIC	D	14	2500	Green (RoHS & no Sb/Br)	CU NIPDAU	Level-1-260C-UNLIM
TLC083CDRG4	ACTIVE	SOIC	D	14	2500	Green (RoHS & no Sb/Br)	CU NIPDAU	Level-1-260C-UNLIM
TLC083CN	ACTIVE	PDIP	N	14	25	Pb-Free (RoHS)	CU NIPD	Level-NC-NC-NC
TLC083CNE4	ACTIVE	PDIP	N	14	25	Pb-Free (RoHS)	CU NIPD	Level-NC-NC-NC
TLC083ID	ACTIVE	SOIC	D	14	50	Green (RoHS & no Sb/Br)	CU NIPDAU	Level-1-260C-UNLIM
TLC083IDGQ	ACTIVE	MSOP-Power PAD	DGQ	10	80	Green (RoHS & no Sb/Br)	CU NIPDAU	Level-1-260C-UNLIM
TLC083IDGQR	ACTIVE	MSOP-Power PAD	DGQ	10	2500	Green (RoHS & no Sb/Br)	CU NIPDAU	Level-1-260C-UNLIM
TLC083IDGQRG4	ACTIVE	MSOP-Power PAD	DGQ	10	2500	Green (RoHS & no Sb/Br)	CU NIPDAU	Level-1-260C-UNLIM
TLC083IDR	ACTIVE	SOIC	D	14	2500	Green (RoHS & no Sb/Br)	CU NIPDAU	Level-1-260C-UNLIM
TLC083IDRG4	ACTIVE	SOIC	D	14	2500	Green (RoHS & no Sb/Br)	CU NIPDAU	Level-1-260C-UNLIM
TLC083IN	ACTIVE	PDIP	N	14	25	Pb-Free (RoHS)	CU NIPD	Level-NC-NC-NC
TLC083INE4	ACTIVE	PDIP	N	14	25	Pb-Free (RoHS)	CU NIPD	Level-NC-NC-NC



Orderable Device	Status <sup>(1)</sup>	Package Type	Package Drawing	Pins	Package Qty	Eco Plan <sup>(2)</sup>	Lead/Ball Finish	MSL Peak Temp <sup>(3)</sup>
TLC084AID	ACTIVE	SOIC	D	14	50	Green (RoHS & no Sb/Br)	CU NIPDAU	Level-1-260C-UNLIM
TLC084AIDG4	ACTIVE	SOIC	D	14	50	Green (RoHS & no Sb/Br)	CU NIPDAU	Level-1-260C-UNLIM
TLC084AIDR	ACTIVE	SOIC	D	14	2500	Green (RoHS & no Sb/Br)	CU NIPDAU	Level-1-260C-UNLIM
TLC084AIDRG4	ACTIVE	SOIC	D	14	2500	Green (RoHS & no Sb/Br)	CU NIPDAU	Level-1-260C-UNLIM
TLC084AIN	ACTIVE	PDIP	N	14	25	Pb-Free (RoHS)	CU NIPD	Level-NC-NC-NC
TLC084AINE4	ACTIVE	PDIP	N	14	25	Pb-Free (RoHS)	CU NIPD	Level-NC-NC-NC
TLC084AIPWP	ACTIVE	HTSSOP	PWP	20	70	Green (RoHS & no Sb/Br)	CU NIPDAU	Level-2-260C-1 YEAR
TLC084AIPWPR	ACTIVE	HTSSOP	PWP	20	2000	Green (RoHS & no Sb/Br)	CU NIPDAU	Level-2-260C-1 YEAR
TLC084CD	ACTIVE	SOIC	D	14	50	Green (RoHS & no Sb/Br)	CU NIPDAU	Level-1-260C-UNLIM
TLC084CDR	ACTIVE	SOIC	D	14	2500	Green (RoHS & no Sb/Br)	CU NIPDAU	Level-1-260C-UNLIM
TLC084CN	ACTIVE	PDIP	N	14	25	Pb-Free (RoHS)	CU NIPD	Level-NC-NC-NC
TLC084CNE4	ACTIVE	PDIP	N	14	25	Pb-Free (RoHS)	CU NIPD	Level-NC-NC-NC
TLC084CPWP	ACTIVE	HTSSOP	PWP	20	70	Green (RoHS & no Sb/Br)	CU NIPDAU	Level-2-260C-1 YEAR
TLC084CPWPG4	ACTIVE	HTSSOP	PWP	20	70	Green (RoHS & no Sb/Br)	CU NIPDAU	Level-2-260C-1 YEAR
TLC084CPWPR	ACTIVE	HTSSOP	PWP	20	2000	Green (RoHS & no Sb/Br)	CU NIPDAU	Level-2-260C-1 YEAR
TLC084CPWPRG4	ACTIVE	HTSSOP	PWP	20	2000	Green (RoHS & no Sb/Br)	CU NIPDAU	Level-2-260C-1 YEAR
TLC084ID	ACTIVE	SOIC	D	14	50	Green (RoHS & no Sb/Br)	CU NIPDAU	Level-1-260C-UNLIM
TLC084IDR	ACTIVE	SOIC	D	14	2500	Green (RoHS & no Sb/Br)	CU NIPDAU	Level-1-260C-UNLIM
TLC084IN	ACTIVE	PDIP	N	14	25	Pb-Free (RoHS)	CU NIPD	Level-NC-NC-NC
TLC084INE4	ACTIVE	PDIP	N	14	25	Pb-Free (RoHS)	CU NIPD	Level-NC-NC-NC
TLC084IPWP	ACTIVE	HTSSOP	PWP	20	70	Green (RoHS & no Sb/Br)	CU NIPDAU	Level-2-260C-1 YEAR
TLC084IPWPR	ACTIVE	HTSSOP	PWP	20	2000	Green (RoHS & no Sb/Br)	CU NIPDAU	Level-2-260C-1 YEAR
TLC084IPWPRG4	ACTIVE	HTSSOP	PWP	20	2000	Green (RoHS & no Sb/Br)	CU NIPDAU	Level-2-260C-1 YEAR
TLC085AID	ACTIVE	SOIC	D	16	40	Green (RoHS & no Sb/Br)	CU NIPDAU	Level-1-260C-UNLIM
TLC085AIDR	ACTIVE	SOIC	D	16	2500	Green (RoHS & no Sb/Br)	CU NIPDAU	Level-1-260C-UNLIM
TLC085AIDRG4	ACTIVE	SOIC	D	16	2500	Green (RoHS & no Sb/Br)	CU NIPDAU	Level-1-260C-UNLIM

Orderable Device	Status <sup>(1)</sup>	Package Type	Package Drawing	Pins	Package Qty	Eco Plan <sup>(2)</sup>	Lead/Ball Finish	MSL Peak Temp <sup>(3)</sup>
TLC085AIN	ACTIVE	PDIP	N	16	25	Pb-Free (RoHS)	CU NIPDAU	Level-NC-NC-NC
TLC085AINE4	ACTIVE	PDIP	N	16	25	Pb-Free (RoHS)	CU NIPDAU	Level-NC-NC-NC
TLC085AIPWP	ACTIVE	HTSSOP	PWP	20	70	Green (RoHS & no Sb/Br)	CU NIPDAU	Level-2-260C-1 YEAR
TLC085AIPWPR	ACTIVE	HTSSOP	PWP	20	2000	Green (RoHS & no Sb/Br)	CU NIPDAU	Level-2-260C-1 YEAR
TLC085AIPWPRG4	ACTIVE	HTSSOP	PWP	20	2000	Green (RoHS & no Sb/Br)	CU NIPDAU	Level-2-260C-1 YEAR
TLC085CD	ACTIVE	SOIC	D	16	40	Green (RoHS & no Sb/Br)	CU NIPDAU	Level-1-260C-UNLIM
TLC085CDR	ACTIVE	SOIC	D	16	2500	Green (RoHS & no Sb/Br)	CU NIPDAU	Level-1-260C-UNLIM
TLC085CDRG4	ACTIVE	SOIC	D	16	2500	Green (RoHS & no Sb/Br)	CU NIPDAU	Level-1-260C-UNLIM
TLC085CN	ACTIVE	PDIP	N	16	25	Pb-Free (RoHS)	CU NIPDAU	Level-NC-NC-NC
TLC085CNE4	ACTIVE	PDIP	N	16	25	Pb-Free (RoHS)	CU NIPDAU	Level-NC-NC-NC
TLC085CPWP	ACTIVE	HTSSOP	PWP	20	70	Green (RoHS & no Sb/Br)	CU NIPDAU	Level-2-260C-1 YEAR
TLC085CPWPR	ACTIVE	HTSSOP	PWP	20	2000	Green (RoHS & no Sb/Br)	CU NIPDAU	Level-2-260C-1 YEAR
TLC085CPWPRG4	ACTIVE	HTSSOP	PWP	20	2000	Green (RoHS & no Sb/Br)	CU NIPDAU	Level-2-260C-1 YEAR
TLC085ID	ACTIVE	SOIC	D	16	40	Green (RoHS & no Sb/Br)	CU NIPDAU	Level-1-260C-UNLIM
TLC085IDG4	ACTIVE	SOIC	D	16	40	Green (RoHS & no Sb/Br)	CU NIPDAU	Level-1-260C-UNLIM
TLC085IDR	ACTIVE	SOIC	D	16	2500	Green (RoHS & no Sb/Br)	CU NIPDAU	Level-1-260C-UNLIM
TLC085IDRG4	ACTIVE	SOIC	D	16	2500	Green (RoHS & no Sb/Br)	CU NIPDAU	Level-1-260C-UNLIM
TLC085IN	ACTIVE	PDIP	N	16	25	Pb-Free (RoHS)	CU NIPDAU	Level-NC-NC-NC
TLC085INE4	ACTIVE	PDIP	N	16	25	Pb-Free (RoHS)	CU NIPDAU	Level-NC-NC-NC
TLC085IPWP	ACTIVE	HTSSOP	PWP	20	70	Green (RoHS & no Sb/Br)	CU NIPDAU	Level-2-260C-1 YEAR
TLC085IPWPG4	ACTIVE	HTSSOP	PWP	20	70	Green (RoHS & no Sb/Br)	CU NIPDAU	Level-2-260C-1 YEAR
TLC085IPWPR	ACTIVE	HTSSOP	PWP	20	2000	Green (RoHS & no Sb/Br)	CU NIPDAU	Level-2-260C-1 YEAR
TLC085IPWPRG4	ACTIVE	HTSSOP	PWP	20	2000	Green (RoHS & no Sb/Br)	CU NIPDAU	Level-2-260C-1 YEAR

<sup>(1)</sup> The marketing status values are defined as follows:

**ACTIVE:** Product device recommended for new designs.

**LIFEBUY:** TI has announced that the device will be discontinued, and a lifetime-buy period is in effect.

**NRND:** Not recommended for new designs. Device is in production to support existing customers, but TI does not recommend using this part in a new design.

**PREVIEW:** Device has been announced but is not in production. Samples may or may not be available.

**OBSOLETE:** TI has discontinued the production of the device.

<sup>(2)</sup> Eco Plan - The planned eco-friendly classification: Pb-Free (RoHS) or Green (RoHS & no Sb/Br) - please check <http://www.ti.com/productcontent> for the latest availability information and additional product content details.

**TBD:** The Pb-Free/Green conversion plan has not been defined.

**Pb-Free (RoHS):** TI's terms "Lead-Free" or "Pb-Free" mean semiconductor products that are compatible with the current RoHS requirements for all 6 substances, including the requirement that lead not exceed 0.1% by weight in homogeneous materials. Where designed to be soldered at high temperatures, TI Pb-Free products are suitable for use in specified lead-free processes.

**Green (RoHS & no Sb/Br):** TI defines "Green" to mean Pb-Free (RoHS compatible), and free of Bromine (Br) and Antimony (Sb) based flame retardants (Br or Sb do not exceed 0.1% by weight in homogeneous material)

<sup>(3)</sup> MSL, Peak Temp. -- The Moisture Sensitivity Level rating according to the JEDEC industry standard classifications, and peak solder temperature.

**Important Information and Disclaimer:**The information provided on this page represents TI's knowledge and belief as of the date that it is provided. TI bases its knowledge and belief on information provided by third parties, and makes no representation or warranty as to the accuracy of such information. Efforts are underway to better integrate information from third parties. TI has taken and continues to take reasonable steps to provide representative and accurate information but may not have conducted destructive testing or chemical analysis on incoming materials and chemicals. TI and TI suppliers consider certain information to be proprietary, and thus CAS numbers and other limited information may not be available for release.

In no event shall TI's liability arising out of such information exceed the total purchase price of the TI part(s) at issue in this document sold by TI to Customer on an annual basis.

PWP (R-PDSO-G\*\*) 20 PIN SHOWN

PowerPAD™ PLASTIC SMALL-OUTLINE PACKAGE

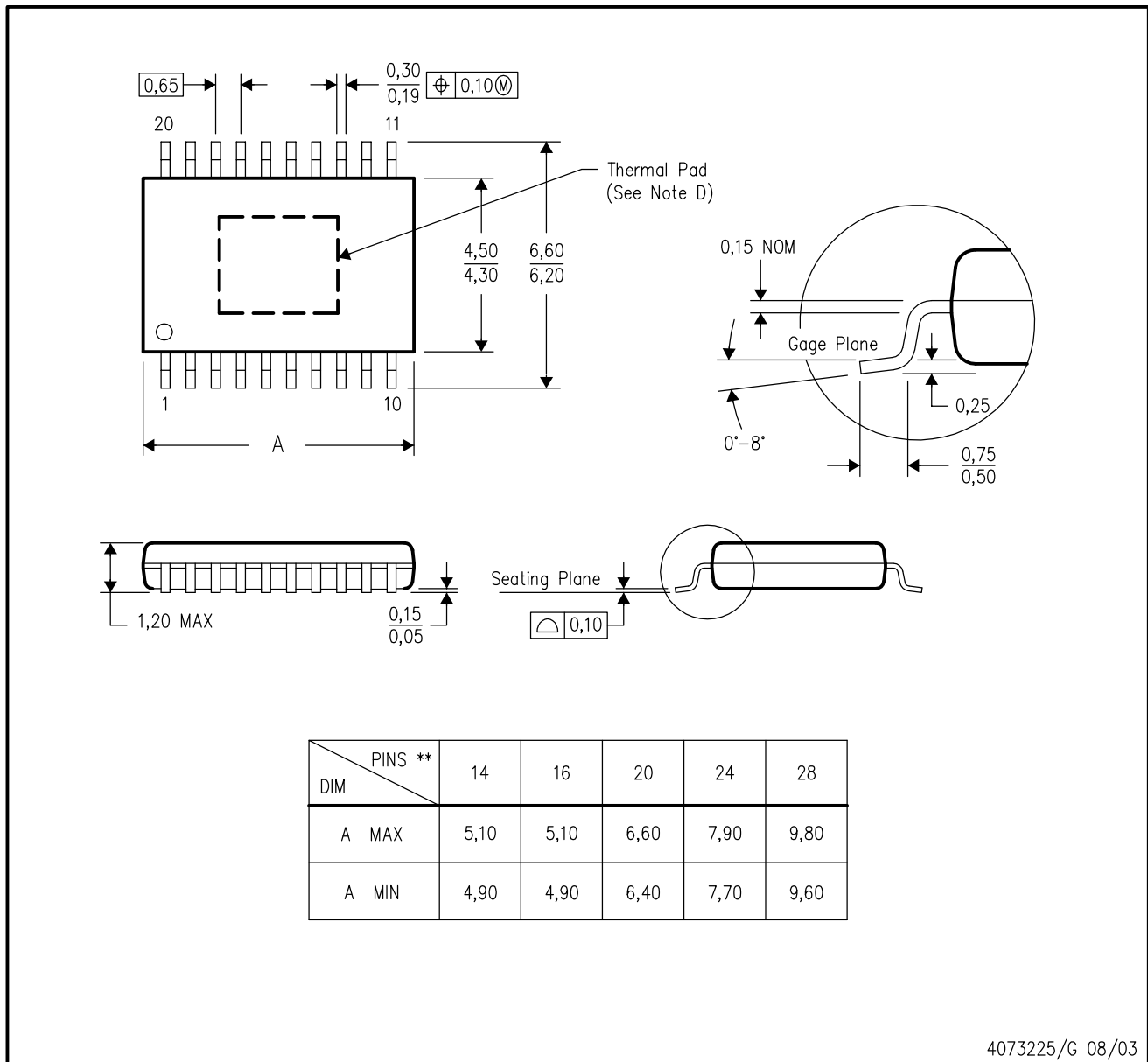

4073225/G 08/03

- NOTES:
- A. All linear dimensions are in millimeters.
  - B. This drawing is subject to change without notice.
  - C. Body dimensions do not include mold flash or protrusions.
  - D. This package is designed to be soldered to a thermal pad on the board. Refer to Technical Brief, PowerPad Thermally Enhanced Package, Texas Instruments Literature No. SLMA002 for information regarding recommended board layout. This document is available at [www.ti.com](http://www.ti.com) <<http://www.ti.com>>.
  - E. Falls within JEDEC MO-153

PowerPAD is a trademark of Texas Instruments.

P (R-PDIP-T8)

PLASTIC DUAL-IN-LINE



- NOTES: A. All linear dimensions are in inches (millimeters).  
 B. This drawing is subject to change without notice.  
 C. Falls within JEDEC MS-001

For the latest package information, go to [http://www.ti.com/sc/docs/package/pkg\\_info.htm](http://www.ti.com/sc/docs/package/pkg_info.htm)



N (R-PDIP-T\*\*)

PLASTIC DUAL-IN-LINE PACKAGE

16 PINS SHOWN



- NOTES:
- A. All linear dimensions are in inches (millimeters).
  - B. This drawing is subject to change without notice.
  - C Falls within JEDEC MS-001, except 18 and 20 pin minimum body length (Dim A).
  - D The 20 pin end lead shoulder width is a vendor option, either half or full width.

4040049/E 12/2002

DGQ (S-PDSO-G10)

PowerPAD™ PLASTIC SMALL-OUTLINE PACKAGE

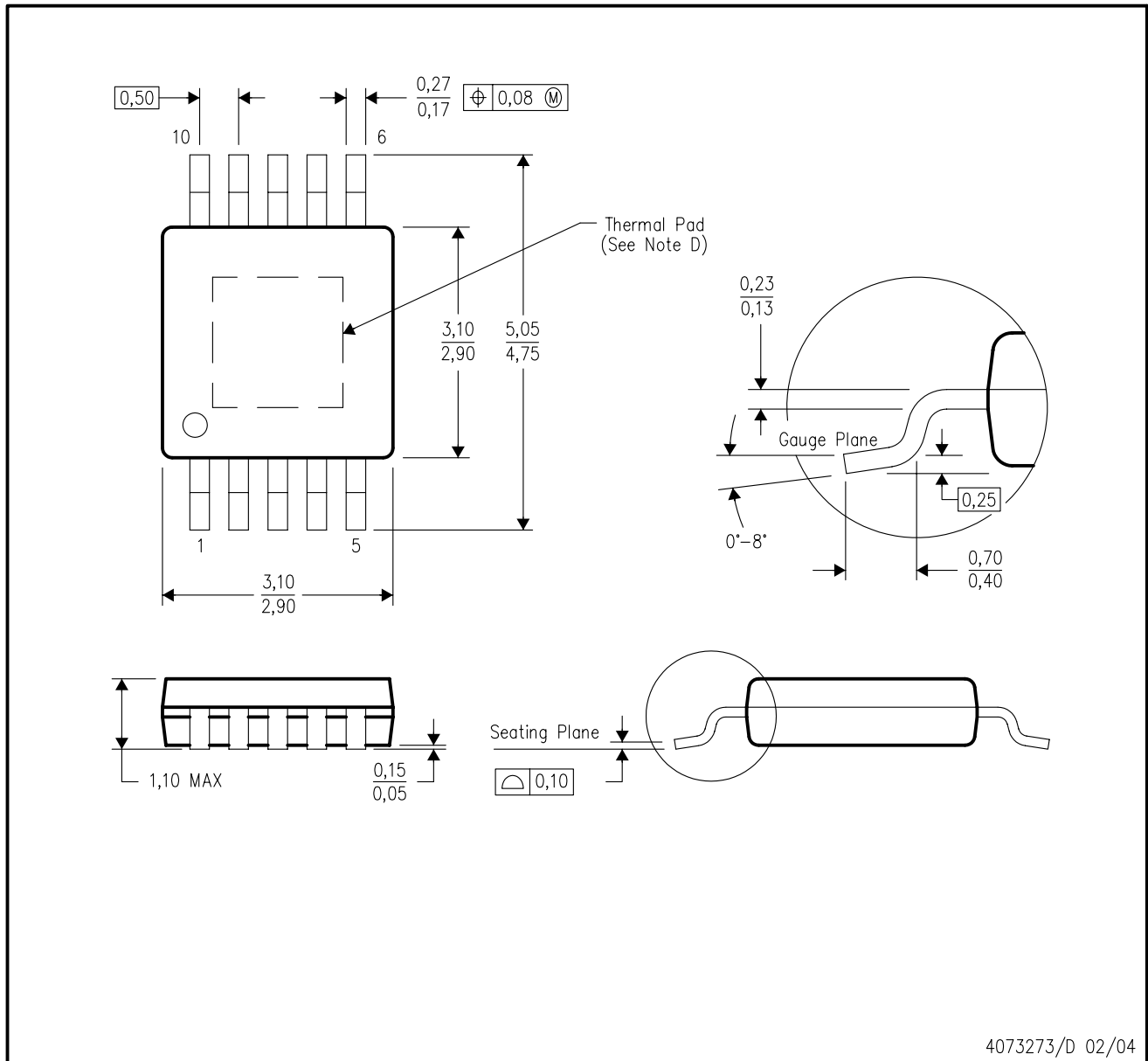

- NOTES:
- A. All linear dimensions are in millimeters.
  - B. This drawing is subject to change without notice.
  - C. Body dimensions do not include mold flash or protrusion.
  - D. This package is designed to be soldered to a thermal pad on the board. Refer to Technical Brief, PowerPAD Thermally Enhanced Package, Texas Instruments Literature No. SLMA002 for information regarding recommended board layout. This document is available at [www.ti.com](http://www.ti.com) <<http://www.ti.com>>.
  - E. Falls within JEDEC MO-187 variation BA-T.

PowerPAD is a trademark of Texas Instruments.

DGN (S-PDSO-G8)

PowerPAD™ PLASTIC SMALL-OUTLINE PACKAGE

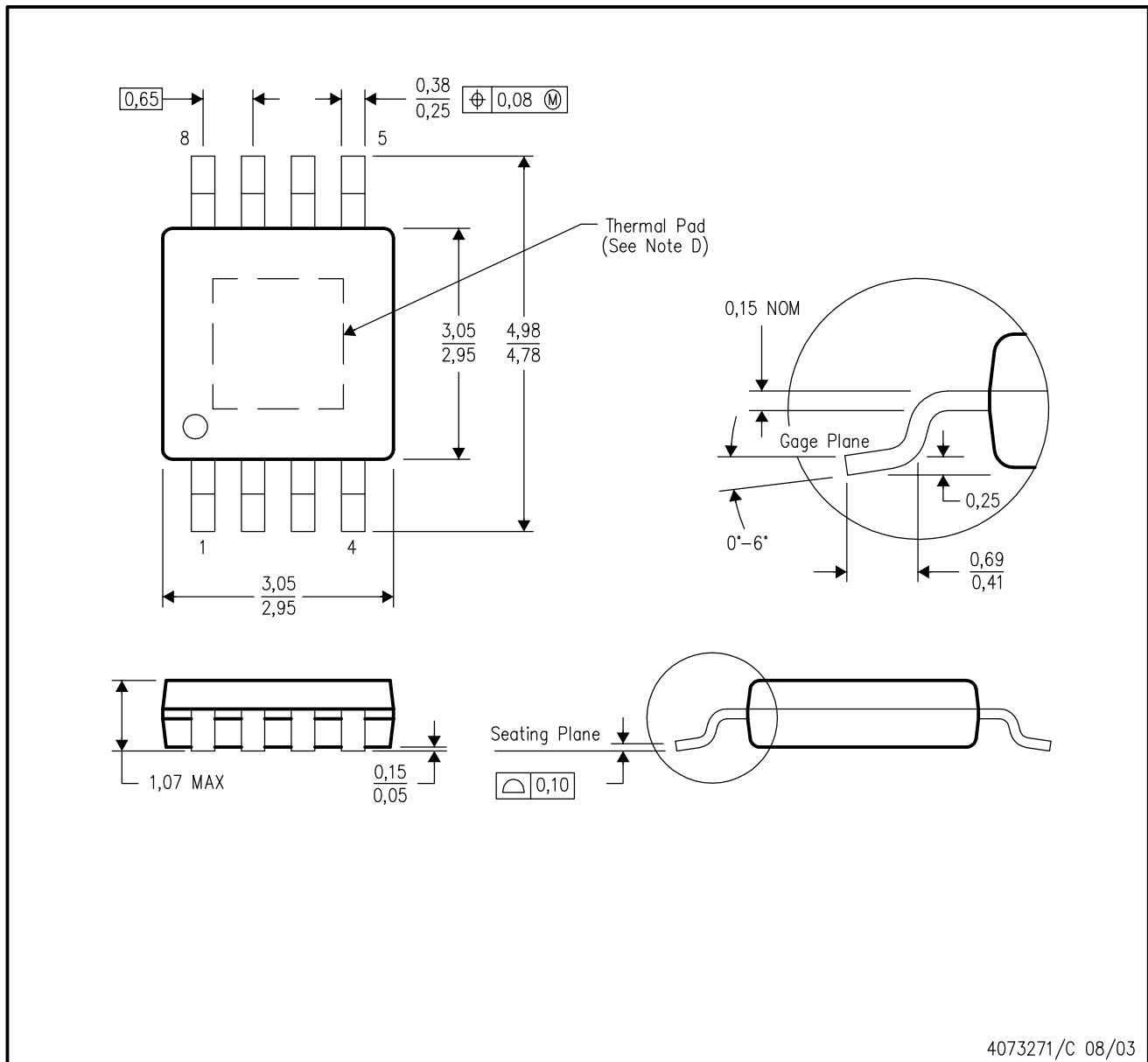

4073271/C 08/03

- NOTES:
- All linear dimensions are in millimeters.
  - This drawing is subject to change without notice.
  - Body dimensions do not include mold flash or protrusion.
  - This package is designed to be soldered to a thermal pad on the board. Refer to Technical Brief, PowerPad Thermally Enhanced Package, Texas Instruments Literature No. SLMA002 for information regarding recommended board layout. This document is available at [www.ti.com](http://www.ti.com) <<http://www.ti.com>>.
  - Falls within JEDEC MO-187

PowerPAD is a trademark of Texas Instruments.







D (R-PDSO-G8)

PLASTIC SMALL-OUTLINE PACKAGE



- NOTES:
- A. All linear dimensions are in inches (millimeters).
  - B. This drawing is subject to change without notice.
  - C. Body dimensions do not include mold flash or protrusion not to exceed 0.006 (0,15).
  - D. Falls within JEDEC MS-012 variation AA.

## IMPORTANT NOTICE

Texas Instruments Incorporated and its subsidiaries (TI) reserve the right to make corrections, modifications, enhancements, improvements, and other changes to its products and services at any time and to discontinue any product or service without notice. Customers should obtain the latest relevant information before placing orders and should verify that such information is current and complete. All products are sold subject to TI's terms and conditions of sale supplied at the time of order acknowledgment.

TI warrants performance of its hardware products to the specifications applicable at the time of sale in accordance with TI's standard warranty. Testing and other quality control techniques are used to the extent TI deems necessary to support this warranty. Except where mandated by government requirements, testing of all parameters of each product is not necessarily performed.

TI assumes no liability for applications assistance or customer product design. Customers are responsible for their products and applications using TI components. To minimize the risks associated with customer products and applications, customers should provide adequate design and operating safeguards.

TI does not warrant or represent that any license, either express or implied, is granted under any TI patent right, copyright, mask work right, or other TI intellectual property right relating to any combination, machine, or process in which TI products or services are used. Information published by TI regarding third-party products or services does not constitute a license from TI to use such products or services or a warranty or endorsement thereof. Use of such information may require a license from a third party under the patents or other intellectual property of the third party, or a license from TI under the patents or other intellectual property of TI.

Reproduction of information in TI data books or data sheets is permissible only if reproduction is without alteration and is accompanied by all associated warranties, conditions, limitations, and notices. Reproduction of this information with alteration is an unfair and deceptive business practice. TI is not responsible or liable for such altered documentation.

Resale of TI products or services with statements different from or beyond the parameters stated by TI for that product or service voids all express and any implied warranties for the associated TI product or service and is an unfair and deceptive business practice. TI is not responsible or liable for any such statements.

Following are URLs where you can obtain information on other Texas Instruments products and application solutions:

<b>Products</b>		<b>Applications</b>	
Amplifiers	<a href="http://amplifier.ti.com">amplifier.ti.com</a>	Audio	<a href="http://www.ti.com/audio">www.ti.com/audio</a>
Data Converters	<a href="http://dataconverter.ti.com">dataconverter.ti.com</a>	Automotive	<a href="http://www.ti.com/automotive">www.ti.com/automotive</a>
DSP	<a href="http://dsp.ti.com">dsp.ti.com</a>	Broadband	<a href="http://www.ti.com/broadband">www.ti.com/broadband</a>
Interface	<a href="http://interface.ti.com">interface.ti.com</a>	Digital Control	<a href="http://www.ti.com/digitalcontrol">www.ti.com/digitalcontrol</a>
Logic	<a href="http://logic.ti.com">logic.ti.com</a>	Military	<a href="http://www.ti.com/military">www.ti.com/military</a>
Power Mgmt	<a href="http://power.ti.com">power.ti.com</a>	Optical Networking	<a href="http://www.ti.com/opticalnetwork">www.ti.com/opticalnetwork</a>
Microcontrollers	<a href="http://microcontroller.ti.com">microcontroller.ti.com</a>	Security	<a href="http://www.ti.com/security">www.ti.com/security</a>
		Telephony	<a href="http://www.ti.com/telephony">www.ti.com/telephony</a>
		Video & Imaging	<a href="http://www.ti.com/video">www.ti.com/video</a>
		Wireless	<a href="http://www.ti.com/wireless">www.ti.com/wireless</a>

Mailing Address: Texas Instruments  
Post Office Box 655303 Dallas, Texas 75265