

CLASS V, ADVANCED LinCMOS™ LOW NOISE PRECISION OPERATIONAL AMPLIFIER

Check for Samples: [TLC2201-SP](#)

FEATURES

- QML-V Qualified SMD 5962-9088203V2A
- Low Input Offset Voltage: 400 μV Max
- Excellent Offset Voltage Stability With Temperature: 0.5 $\mu\text{V}/^\circ\text{C}$ Typ
- Rail-to-Rail Output Swing
- Low Input Bias Current: 1 pA Typ at $T_A = 25^\circ\text{C}$
- Common-Mode Input Voltage Range Includes the Negative Rail
- Fully Specified For Both Single-Supply and Split-Supply Operation

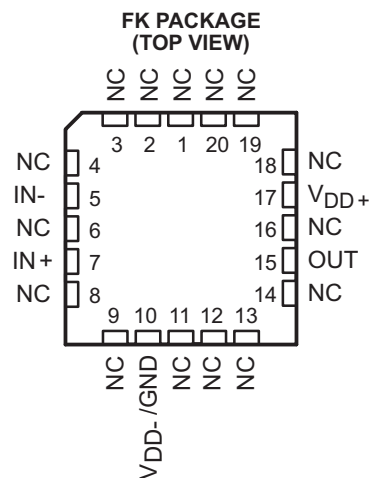

NC - No internal connection

DESCRIPTION

The TLC2201 is a precision, low-noise operational amplifier using Texas Instruments Advanced LinCMOS™ process. This device combines the noise performance of the lowest-noise JFET amplifiers with the dc precision available previously only in bipolar amplifiers. The Advanced LinCMOS™ process uses silicon-gate technology to obtain input offset voltage stability with temperature and time that far exceeds that obtainable using metal-gate technology. In addition, this technology makes possible input impedance levels that meet or exceed levels offered by top-gate JFET and expensive dielectric-isolated devices.

The combination of excellent DC and noise performance with a common-mode input voltage range that includes the negative rail makes these devices an ideal choice for high-impedance, low-level signal-conditioning applications in either single-supply or split-supply configurations.

The device inputs and outputs are designed to withstand -100-mA surge currents without sustaining latch-up. In addition, internal ESD-protection circuits prevent functional failures at voltages up to 2000 V as tested under MIL-PRF-38535, Method 3015.2; however, care should be exercised in handling these devices as exposure to ESD may result in degradation of the parametric performance.

The TLC2201 is characterized for operation over the full military temperature range of -55°C to 125°C .



Please be aware that an important notice concerning availability, standard warranty, and use in critical applications of Texas Instruments semiconductor products and disclaimers thereto appears at the end of this data sheet.

LinCMOS is a trademark of Texas Instruments.

Parts, PSpice are trademarks of MicroSim Corporation.

PRODUCTION DATA information is current as of publication date. Products conform to specifications per the terms of the Texas Instruments standard warranty. Production processing does not necessarily include testing of all parameters.

© 2011, Texas Instruments Incorporated



This integrated circuit can be damaged by ESD. Texas Instruments recommends that all integrated circuits be handled with appropriate precautions. Failure to observe proper handling and installation procedures can cause damage.

ESD damage can range from subtle performance degradation to complete device failure. Precision integrated circuits may be more susceptible to damage because very small parametric changes could cause the device not to meet its published specifications.

**TYPICAL EQUIVALENT
INPUT NOISE VOLTAGE
vs
FREQUENCY**

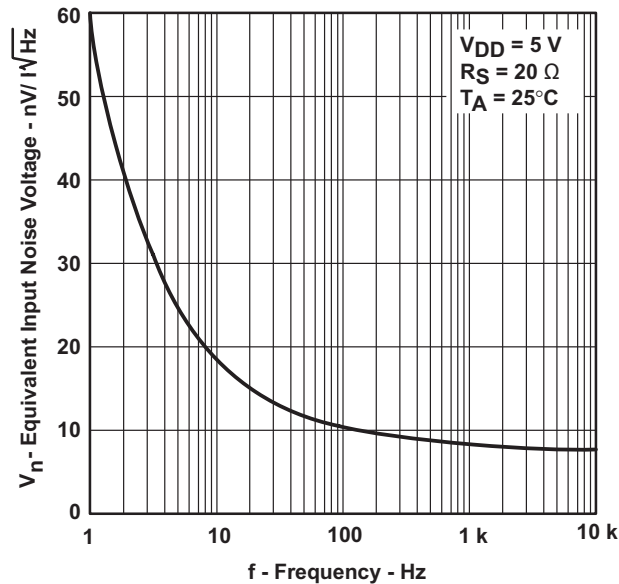

ORDERING INFORMATION⁽¹⁾

TEMPERATURE	PACKAGE ⁽²⁾	ORDERABLE PART NUMBER	TOP-SIDE MARKING
-55°C to 125°C T _{case}	20-pin FK	5962-9088203V2A	5962-9088203V2A TLC2201AMFKBQMLV

- (1) For the most current package and ordering information, see the Package Option Addendum at the end of this document, or see the TI web site at www.ti.com.
- (2) Package drawings, thermal data, and symbolization are available at www.ti.com/packaging.

EQUIVALENT SCHEMATIC

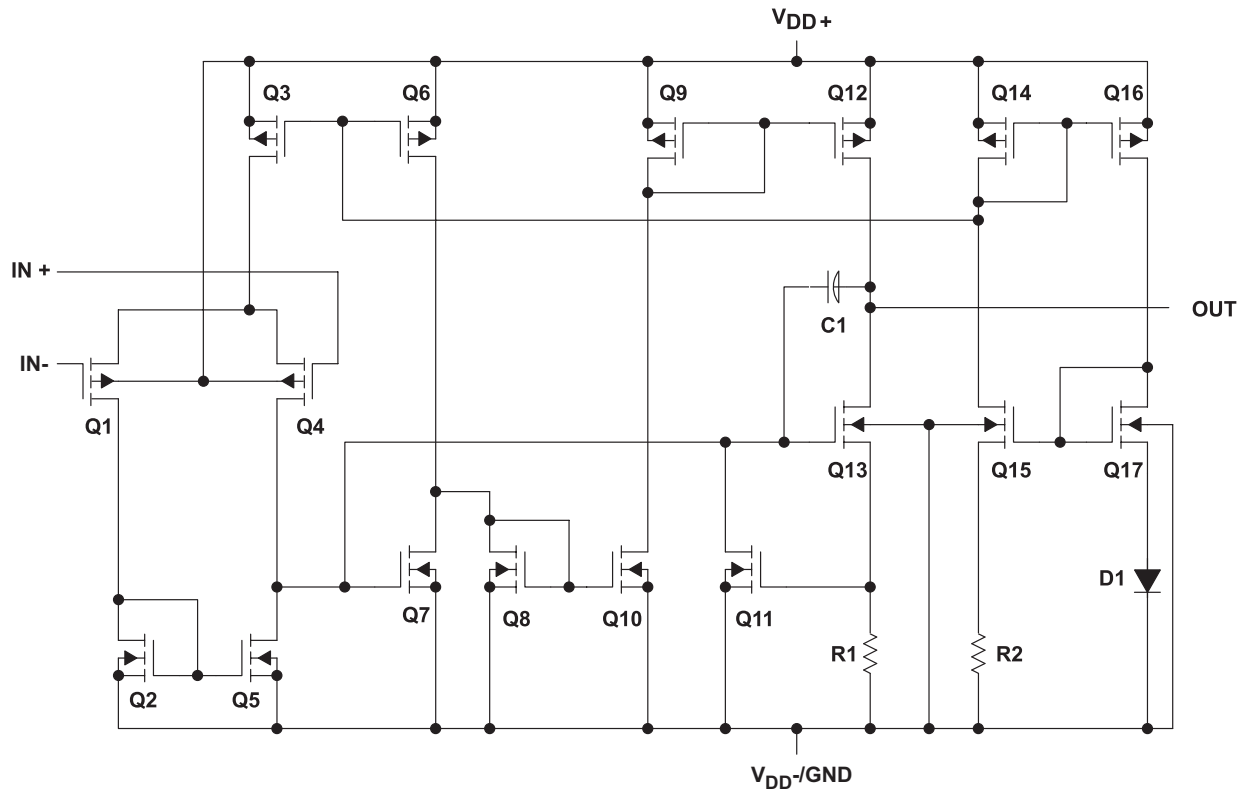

ACTUAL DEVICE COMPONENT COUNT	
COMPONENT	TLC2201
Transistors	17
Resistors	2
Diodes	1
Capacitors	1

ABSOLUTE MAXIMUM RATINGS⁽¹⁾

Over operating free-air temperature range (unless otherwise noted).

		VALUE	UNIT
V _{DD}	Supply voltage ⁽²⁾ , V _{DD-} to V _{DD+}	-8 to 8	V
V _{ID}	Differential input voltage ⁽³⁾	±16	V
V _I	Input voltage (any input)	±8	V
I _I	Input current (each input)	±5	mA
I _O	Output current (each output)	±50	mA
	Duration of short-circuit current at (or below) 25°C ⁽⁴⁾	Unlimited	
	Continuous total power dissipation	See Dissipation Ratings Table	
T _C	Operating case temperature	-55 to 125	°C
T _{stg}	Storage temperature	-65 to 150	°C
	Case temperature for 60 seconds	260	°C

- (1) Stresses beyond those listed under *absolute maximum ratings* may cause permanent damage to the device. These are stress ratings only and functional operation of the device at these or any other conditions beyond those indicated under *recommended operating conditions* is not implied. Exposure to absolute-maximum-rated conditions for extended periods may affect device reliability.
- (2) All voltage values except differential voltages are with respect to the midpoint between V_{DD+} and V_{DD-}.
- (3) Differential voltages are at IN+ with respect to IN-.
- (4) The output may be shorted to either supply. Temperature and/or supply voltages must be limited to ensure that the maximum dissipation rating is not exceeded.

THERMAL RESISTANCE FOR FK PACKAGE⁽¹⁾⁽²⁾

over operating free-air temperature range (unless otherwise noted)

PARAMETER		TEST CONDITIONS	MIN	TYP	MAX	UNIT
R _{θJC}	Junction-to-case thermal resistance	MIL-STD-883 test method 1012			16	°C/W

- (1) Maximum power dissipation is a function of T_J (max), θ_{JC} and T_C. The maximum allowable power dissipation at any allowable case temperature is PD = (T_J (max) - T_C)/θ_{JC}. Operating at the absolute maximum T_J of 150°C can affect reliability.
- (2) The package thermal impedance is calculated in accordance with MIL-STD-883.

RECOMMENDED OPERATING CONDITIONS

		MIN	MAX	UNIT
V _{DD±}	Supply voltage	±2.3	±8	V
V _{IC}	Common-mode input voltage	V _{DD-}	V _{DD+} -2.3	V
T _C	Operating case temperature	-55	125	°C

ELECTRICAL CHARACTERISTICS

over operating free-air temperature range, $V_{DD} = 5\text{ V}$ (unless otherwise noted)

PARAMETER		TEST CONDITIONS	$T_A^{(1)}$	MIN	TYP	MAX	UNIT		
V_{IO}	Input offset voltage	$V_{IC} = 0,$ $R_S = 50\ \Omega$	25°C		80	200	μV		
			Full range			400			
α_{VIO}	Temperature coefficient of input offset voltage		Full range		0.5		$\mu\text{V}/^\circ\text{C}$		
	Input offset voltage long-term drift ⁽²⁾		25°C		0.001		$\mu\text{V}/\text{mo}$		
I_{IO}	Input offset current		25°C		0.5		pA		
			Full range			500			
I_{IB}	Input bias current		25°C		1		pA		
			Full range			500			
V_{ICR}	Common-mode input voltage range	$R_S = 50\ \Omega$	Full range	0 to 2.7			V		
V_{OH}	Maximum high-level output voltage	$R_L = 10\ \text{k}\Omega$	25°C	4.7	4.8		V		
			Full range	4.7					
V_{OL}	Maximum low-level output voltage		$I_O = 0$	25°C	0	50	mV		
			Full range			50			
A_{VD}	Large-signal differential voltage amplification		$V_O = 1\ \text{V to } 4\ \text{V},$ $R_L = 500\ \text{k}\Omega$	25°C	150	315	V/mV		
				Full range	75				
				25°C	$V_O = 1\ \text{V to } 4\ \text{V},$ $R_L = 10\ \text{k}\Omega$	25		55	
						Full range		10	
CMRR	Common-mode rejection ratio	$V_{IC} = V_{ICRmin},$ $V_O = 0,$ $R_S = 50\ \Omega$	25°C	90	110	dB			
			Full range	85					
k_{SVR}	Supply voltage rejection ratio ($\Delta V_{DD\pm}/\Delta V_{IO}$)		$V_{DD} = 4.6\ \text{V to } 16\ \text{V}$	25°C	90	110	dB		
				Full range	85				
I_{DD}	Supply current			$V_O = 2.5\ \text{V},$ No load	25°C		1.1	1.5	mA
					Full range			1.5	
SR	Slew rate at unity gain				$V_O = 0.5\ \text{V to } 2.5\ \text{V},$ $R_L = 10\ \text{k}\Omega$ $C_L = 100\ \text{pF}$	25°C	1.8	2.5	V/ μs
						Full range	1.1		
V_n	Equivalent input noise voltage	f = 10 Hz				25°C		18	$\text{nV}/\sqrt{\text{Hz}}$
		f = 1 kHz				25°C		8	
$V_{n(pp)}$	Peak-to-peak equivalent input noise voltage	f = 0.1 to 1 Hz	25°C				0.5	μV	
		f = 0.1 to 10 Hz	25°C				0.7		
I_n	Equivalent input noise current		25°C			0.6	$\text{fA}/\sqrt{\text{Hz}}$		
	Gain-bandwidth product	f = 10 kHz, $R_L = 10\ \text{k}\Omega,$ $C_L = 100\ \text{pF}$	25°C			1.8	MHz		
Φ_m	Phase margin at unity gain	$R_L = 10\ \text{k}\Omega,$ $C_L = 100\ \text{pF}$	25°C		45°				

(1) Full range is -55°C to 125°C .

(2) Typical values are based on the input offset voltage shift observable through 168 hours of operating life test at $T_A = 150^\circ\text{C}$ extrapolated to $T_A = 25^\circ\text{C}$ using the Arrhenius equation and assuming an activation energy of 0.96 eV.

ELECTRICAL CHARACTERISTICS

over operating free-air temperature range, $V_{DD} = \pm 5$ V (unless otherwise noted)

PARAMETER		TEST CONDITIONS	$T_A^{(1)}$	MIN	TYP	MAX	UNIT	
V_{IO}	Input offset voltage	$V_{IC} = 0,$ $R_S = 50 \Omega$	25°C		80	200	μV	
			Full range			400		
α_{VIO}	Temperature coefficient of input offset voltage		Full range		0.5		$\mu V/^\circ C$	
	Input offset voltage long-term drift ⁽²⁾		25°C		0.001		$\mu V/mo$	
I_{IO}	Input offset current		25°C		0.5		pA	
			Full range			500		
I_{IB}	Input bias current	25°C		1		pA		
		Full range			500			
V_{ICR}	Common-mode input voltage range	$R_S = 50 \Omega$	Full range	-5 to 2.7			V	
V_{OM+}	Maximum positive peak output voltage swing	$R_L = 10 k\Omega$	25°C	4.7	4.8		V	
			Full range	4.7				
V_{OM-}	Maximum negative peak output voltage swing		25°C	-4.7	-4.9		V	
			Full range	-4.7				
A_{VD}	Large-signal differential voltage amplification	$V_O = \pm 4$ V, $R_L = 500 k\Omega$	25°C	400	560		V/mV	
			Full range	200				
			25°C	$V_O = \pm 4$ V, $R_L = 10 k\Omega$	90	100		
					Full range	45		
CMRR	Common-mode rejection ratio	$V_{IC} = V_{ICRmin},$ $V_O = 0,$ $R_S = 50 \Omega$	25°C	90	115		dB	
			Full range	85				
k_{SVR}	Supply voltage rejection ratio ($\Delta V_{DD\pm}/\Delta V_{IO}$)	$V_{DD} = \pm 2.3$ V to ± 8 V	25°C	90	110		dB	
			Full range	85				
I_{DD}	Supply current	$V_O = 0$ V, No load	25°C		1.1	1.5	mA	
			Full range			1.5		
SR	Slew rate at unity gain	$V_O = \pm 2.3$ V, $R_L = 10 k\Omega$ $C_L = 100$ pF	25°C	2	2.7		V/ μs	
			Full range	1.3				
V_n	Equivalent input noise voltage	f = 10 Hz	25°C		18		nV/ \sqrt{Hz}	
		f = 1 kHz	25°C		8			
$V_{n(pp)}$	Peak-to-peak equivalent input noise voltage	f = 0.1 to 1 Hz	25°C		0.5		μV	
		f = 0.1 to 10 Hz	25°C		0.7			
I_n	Equivalent input noise current		25°C		0.6		fA/ \sqrt{Hz}	
	Gain-bandwidth product	f = 10 kHz, $R_L = 10 k\Omega,$ $C_L = 100$ pF	25°C		1.9		MHz	
Φ_m	Phase margin at unity gain	$R_L = 10 k\Omega,$ $C_L = 100$ pF	25°C		48°			

(1) Full range is $-55^\circ C$ to $125^\circ C$.

(2) Typical values are based on the input offset voltage shift observable through 168 hours of operating life test at $T_A = 150^\circ C$ extrapolated to $T_A = 25^\circ C$ using the Arrhenius equation and assuming an activation energy of 0.96 eV.

PARAMETER MEASUREMENT INFORMATION

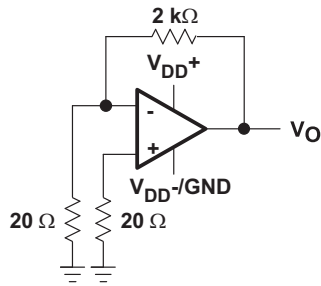
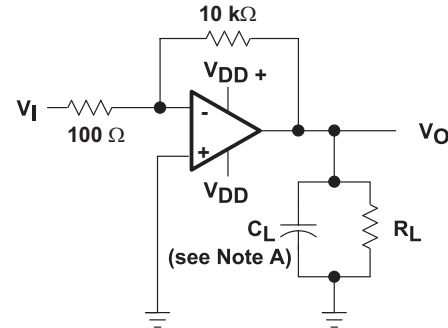
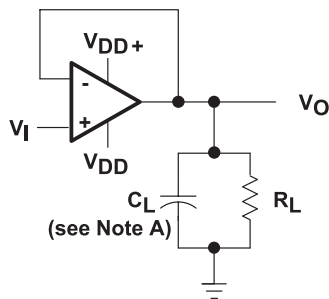

Figure 1. Noise-Voltage Test Circuit



NOTE A: C_L includes fixture capacitance.

Figure 2. Phase-Margin Test Circuit



NOTE A: C_L includes fixture capacitance.

Figure 3. Slew-Rate Test Circuit

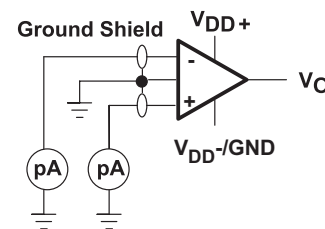

Figure 4. Input-Bias and Offset-Current Test Circuit

TYPICAL VALUES

Typical values presented in this data sheet represent the median (50% point) of device parametric performance.

INPUT BIAS AND OFFSET CURRENT

At the picoamp bias current level of the TLC2201 accurate measurement of the bias current becomes difficult. Not only does this measurement require a picoammeter, but test socket leakages can easily exceed the actual device bias currents. To measure these small currents, Texas Instruments uses a two-step process. The socket leakage is measured using picoammeters with bias voltages applied but with no device in the socket. The device is then inserted in the socket, and a second test measuring both the socket leakage and the device input bias current is performed. The two measurements are then subtracted algebraically to determine the bias current of the device.

NOISE

Texas Instruments offers automated production noise testing to meet individual application requirements. Noise voltage at $f = 10$ Hz and $f = 1$ kHz is sample tested on every TLC2201. For other noise requirements, please contact the factory.

TYPICAL CHARACTERISTICS

Table of Graphs

			FIGURE
V_{IO}	Input offset voltage	Distribution	Figure 5
I_{IB}	Input bias current	vs Common-mode input voltage	Figure 6
		vs Free-air temperature	Figure 7
V_{OM}	Maximum peak output voltage	vs Output curre	Figure 8
		vs Free-air temperature	Figure 9
$V_{O(PP)}$	Maximum peak-to-peak output voltage	vs Frequency	Figure 10
V_{OH}	High-level output voltage	vs Frequency	Figure 11
		vs High-level output current	Figure 12
		vs Free-air temperature	Figure 13
V_{OL}	Low-level output voltage	vs Low-level output current	Figure 14
		vs Free-air temperature	Figure 15
A_{VD}	Large-signal differential voltage amplification	vs Frequency	Figure 16
		vs Free-air temperature	Figure 17
I_{OS}	Short-circuit output current	vs Supply voltage	Figure 18
		vs Free-air temperature	Figure 19
CMRR	Common-mode rejection ratio	vs Frequency	Figure 20
I_{DD}	Supply current	vs Supply voltage	Figure 21
		vs Free-air temperature	Figure 22
	Pulse response	Small signal	Figure 23
			Figure 24
		Large signal	Figure 25
			Figure 26
SR	Slew rate	vs Supply voltage	Figure 27
		vs Free-air temperature	Figure 28
	Noise voltage (referred to input)	0.1 Hz to 1 Hz	Figure 29
		0.1 Hz to 10 Hz	Figure 30
	Gain-bandwidth product	vs Supply voltage	Figure 31
		vs Free-air temperature	Figure 32
Φ_m	Phase margin	vs Supply voltage	Figure 33
		vs Free-air temperature	Figure 34
	Phase shift	vs Frequency	Figure 16

TYPICAL CHARACTERISTICS

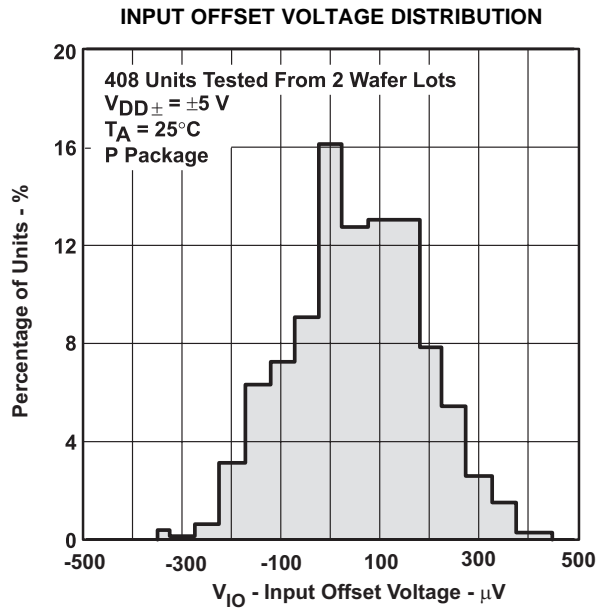

Figure 5.

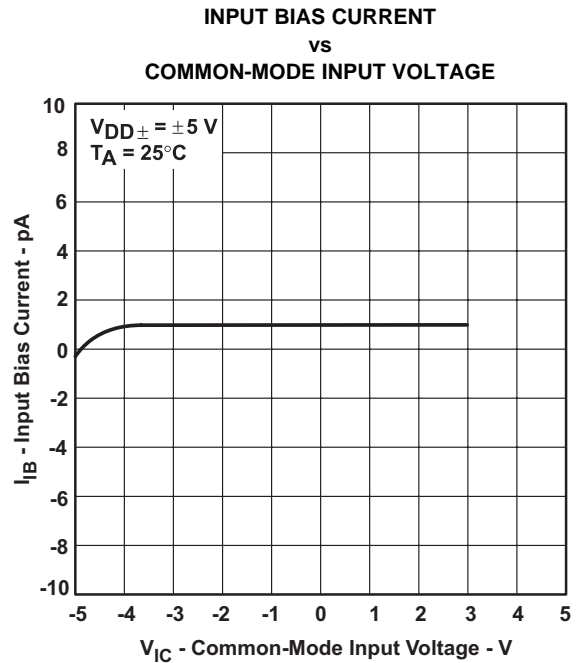

Figure 6.

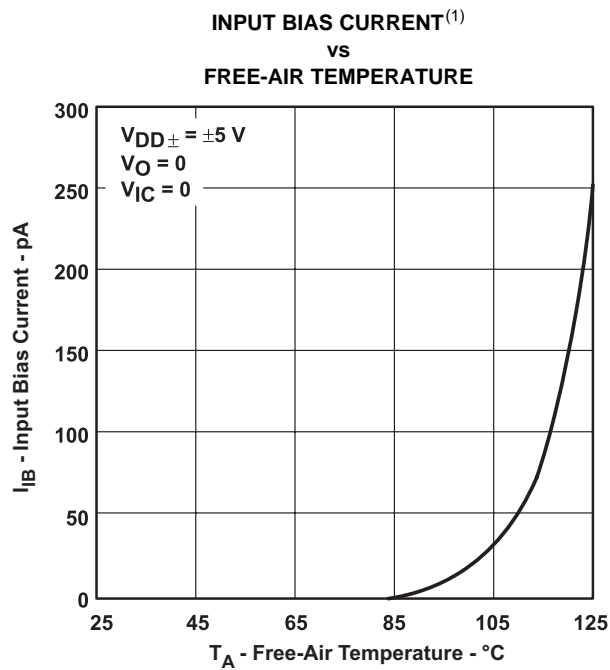

Figure 7.

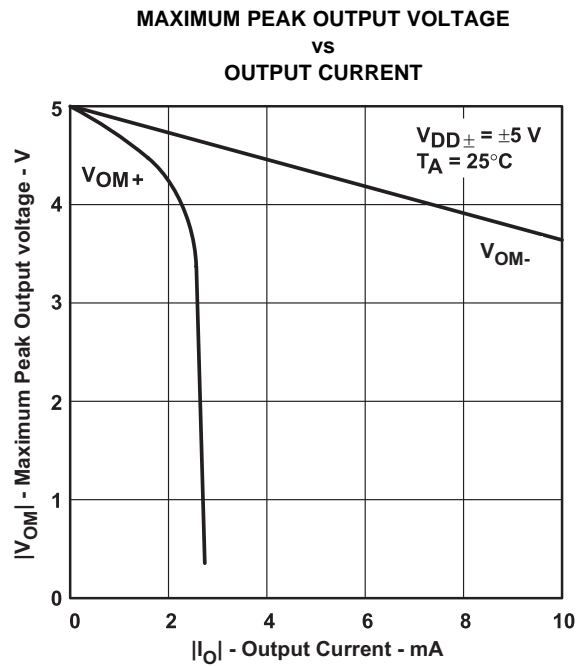

Figure 8.

(1) Data at high and low temperatures are applicable only within the rated operating free-air temperature ranges of the various devices.

TYPICAL CHARACTERISTICS (continued)

**MAXIMUM PEAK OUTPUT VOLTAGE⁽²⁾
vs
FREE-AIR TEMPERATURE**

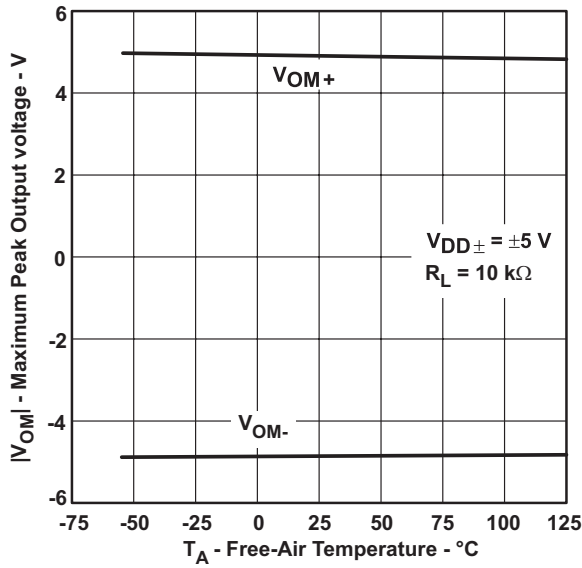

Figure 9.

**MAXIMUM PEAK-TO-PEAK OUTPUT VOLTAGE
vs
FREQUENCY**

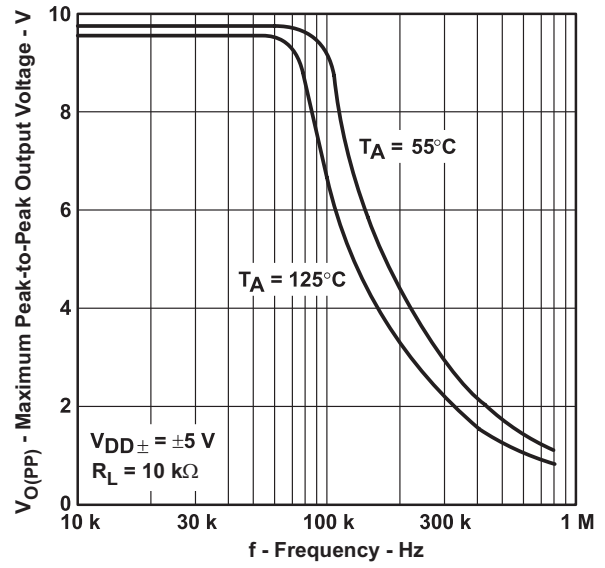

Figure 10.

**HIGH-LEVEL OUTPUT VOLTAGE
vs
FREQUENCY**

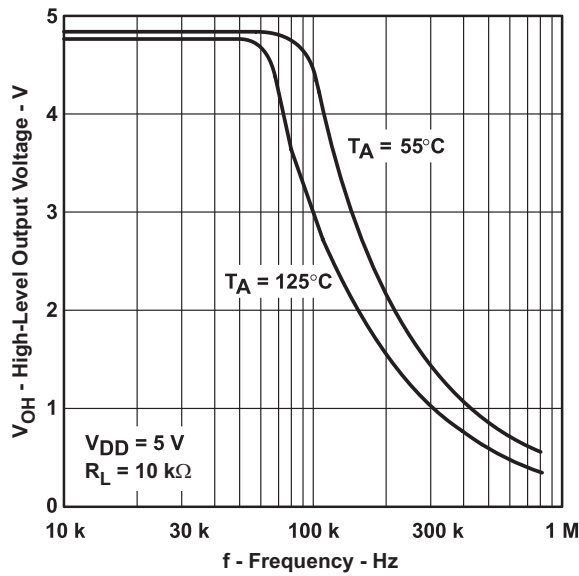

Figure 11.

**HIGH-LEVEL OUTPUT VOLTAGE
vs
HIGH-LEVEL OUTPUT CURRENT**

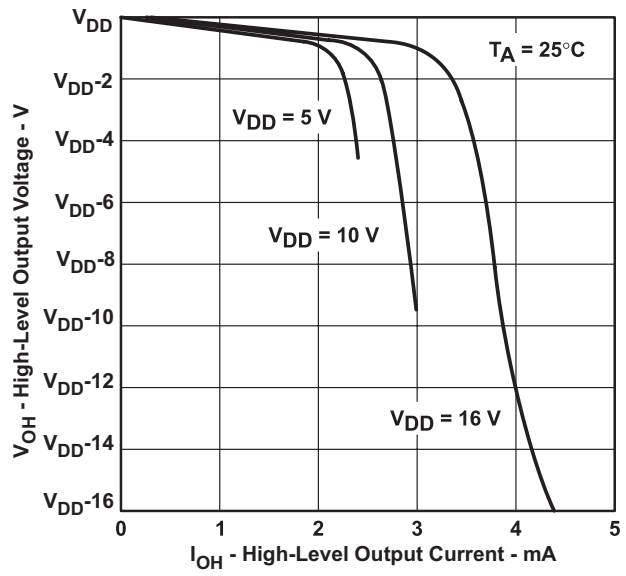

Figure 12.

(2) Data at high and low temperatures are applicable only within the rated operating free-air temperature ranges of the various devices.

TYPICAL CHARACTERISTICS (continued)

HIGH-LEVEL OUTPUT VOLTAGE
vs
FREE-AIR TEMPERATURE

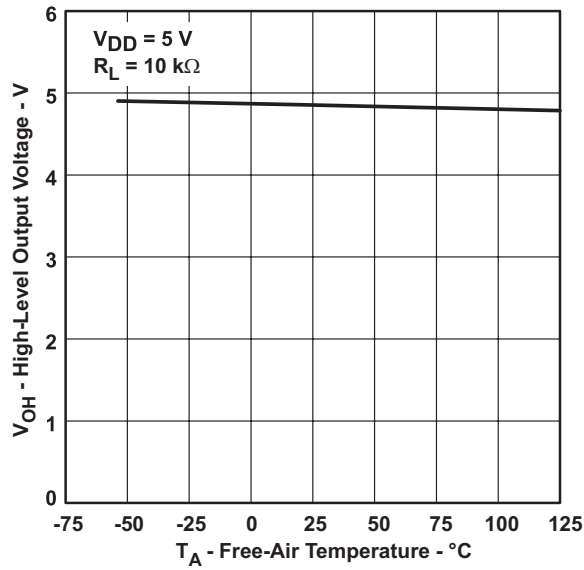

Figure 13.

LOW-LEVEL OUTPUT VOLTAGE
vs
LOW-LEVEL OUTPUT CURRENT

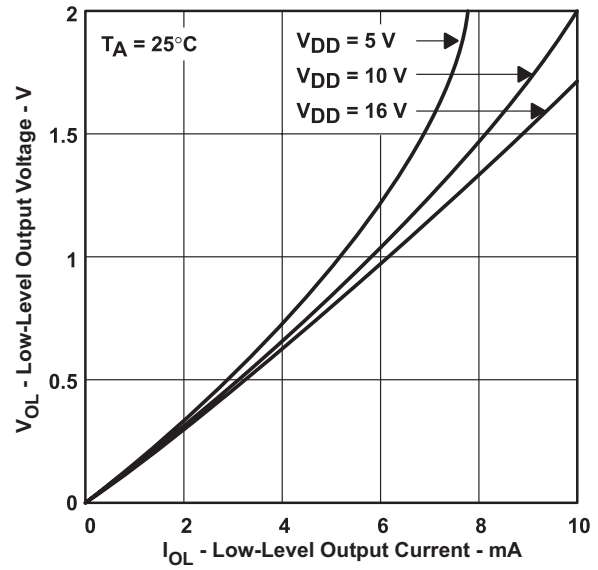

Figure 14.

LOW-LEVEL OUTPUT VOLTAGE
vs
FREE-AIR TEMPERATURE

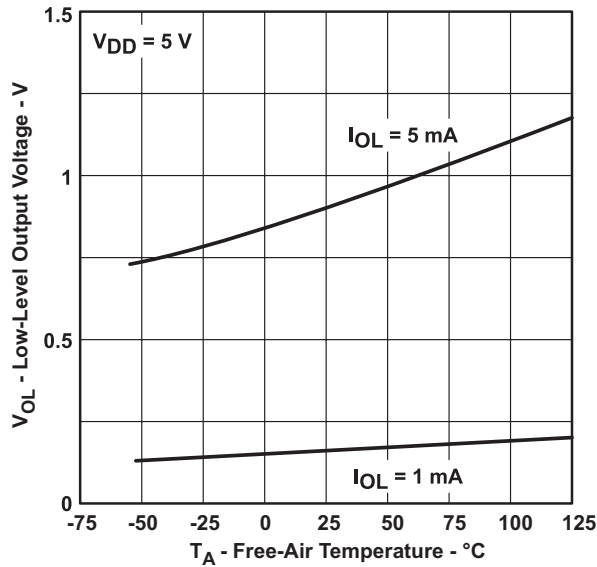

Figure 15.

LARGE-SIGNAL DIFFERENTIAL VOLTAGE
AMPLIFICATION AND PHASE SHIFT
vs
FREQUENCY

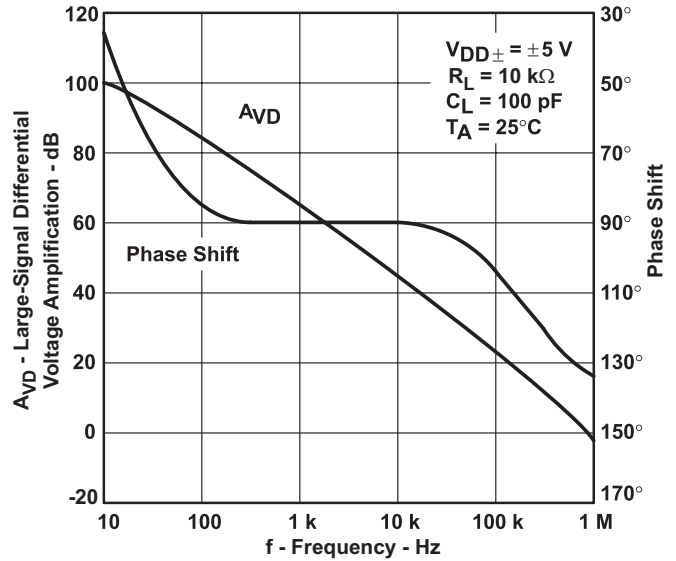

Figure 16.

TYPICAL CHARACTERISTICS (continued)

LARGE-SIGNAL DIFFERENTIAL VOLTAGE AMPLIFICATION

vs
FREE-AIR TEMPERATURE

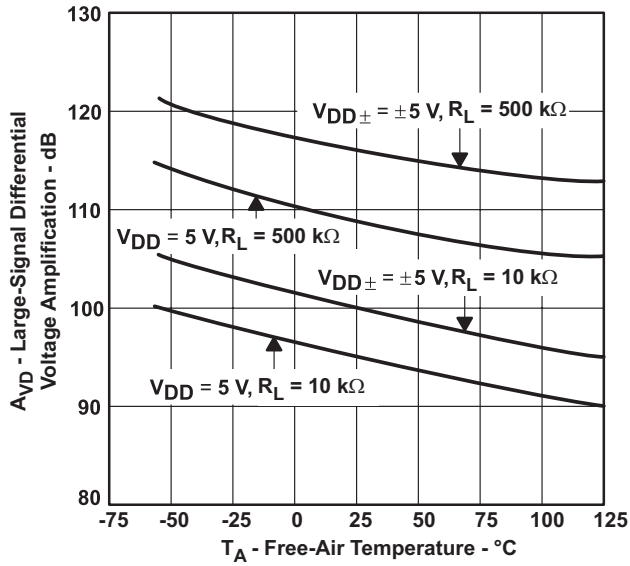

Figure 17.

SHORT-CIRCUIT OUTPUT CURRENT

vs
SUPPLY VOLTAGE

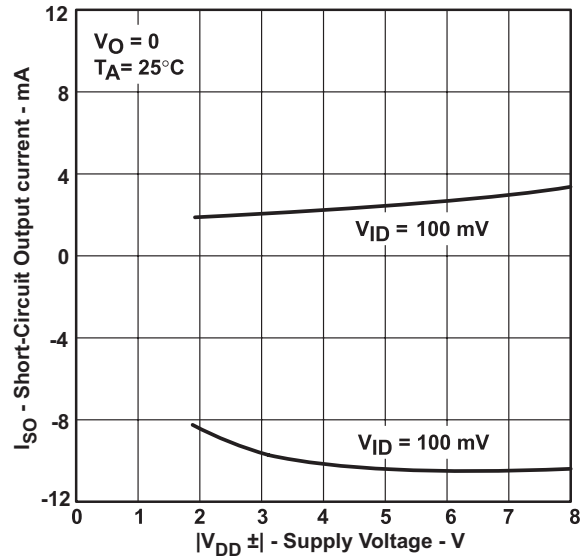

Figure 18.

SHORT-CIRCUIT OUTPUT CURRENT

vs
FREE-AIR TEMPERATURE

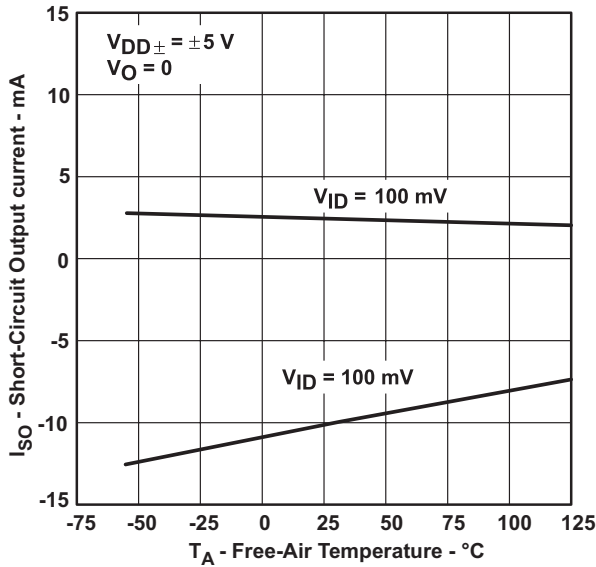

Figure 19.

COMMON-MODE REJECTION RATIO

vs
FREQUENCY

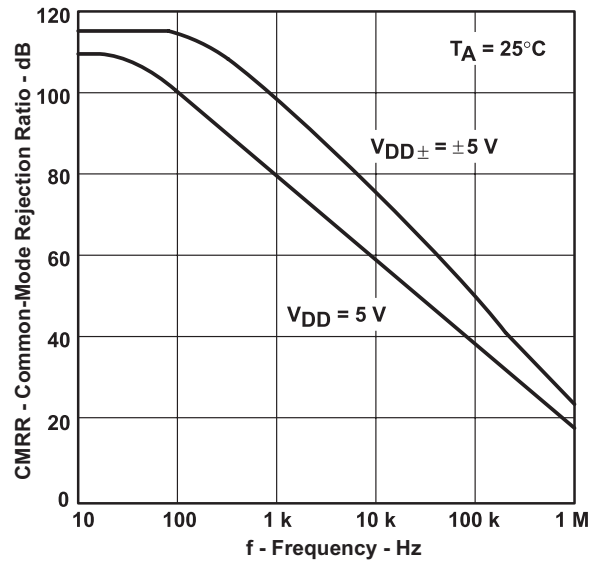

Figure 20.

TYPICAL CHARACTERISTICS (continued)

SUPPLY CURRENT
vs
SUPPLY VOLTAGE

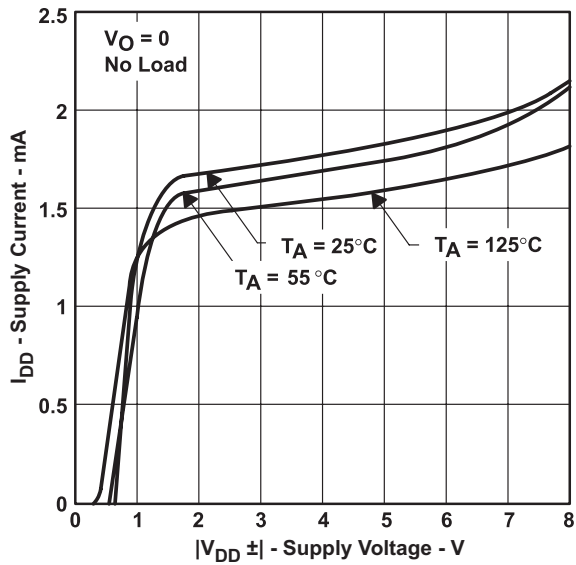

Figure 21.

SUPPLY CURRENT
vs
FREE-AIR TEMPERATURE

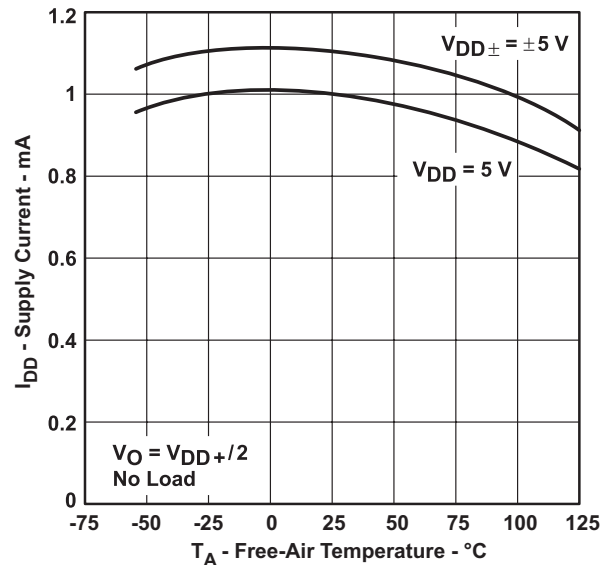

Figure 22.

VOLTAGE-FOLLOWER
SMALL-SIGNAL
PULSE RESPONSE

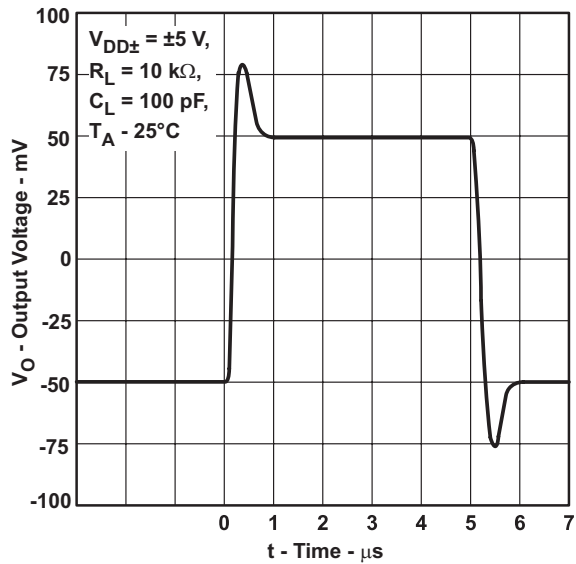

Figure 23.

VOLTAGE-FOLLOWER
SMALL-SIGNAL
PULSE RESPONSE

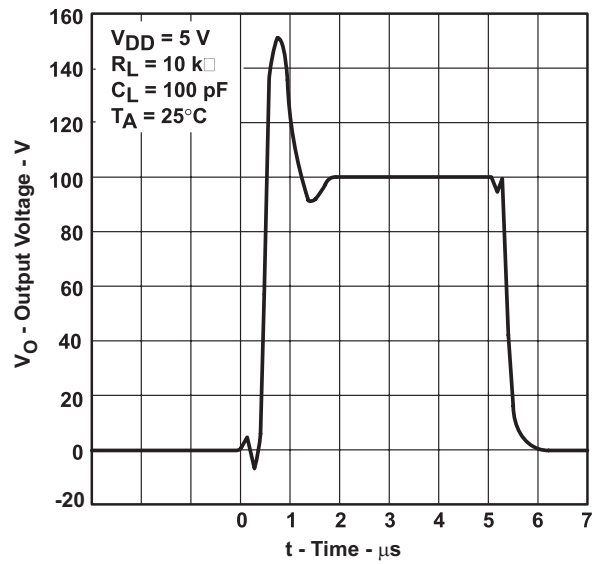

Figure 24.

TYPICAL CHARACTERISTICS (continued)

**VOLTAGE-FOLLOWER
LARGE-SIGNAL
PULSE RESPONSE**

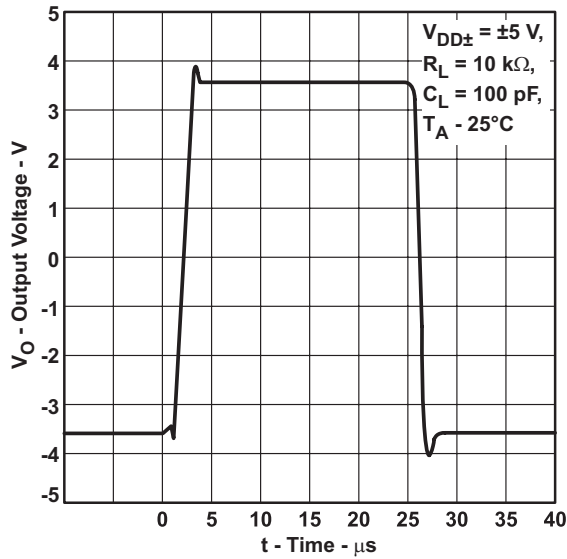

Figure 25.

**VOLTAGE-FOLLOWER
LARGE-SIGNAL
PULSE RESPONSE**

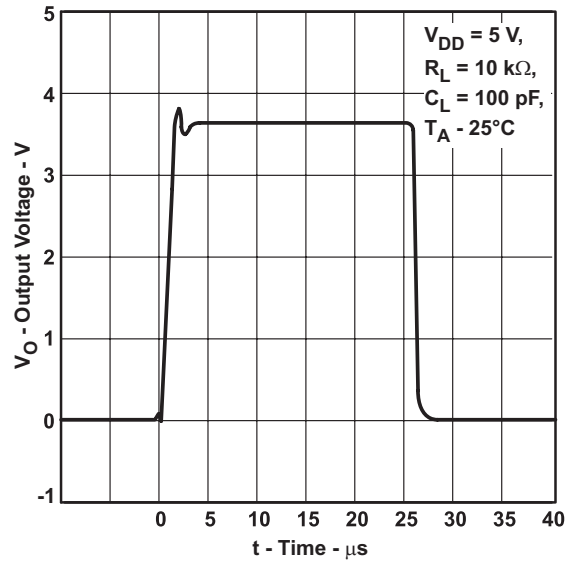

Figure 26.

**SLEW RATE
vs
SUPPLY VOLTAGE**

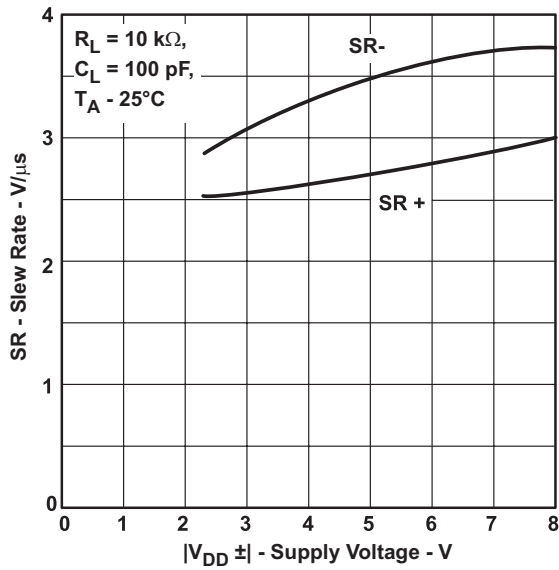

Figure 27.

**SLEW RATE
vs
FREE-AIR TEMPERATURE**

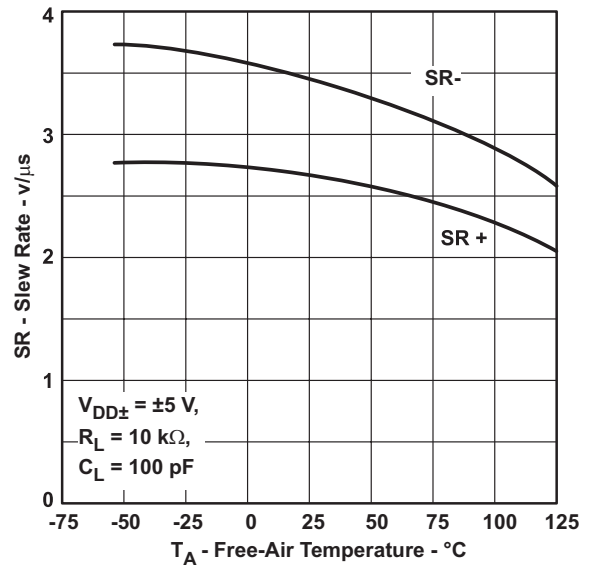

Figure 28.

TYPICAL CHARACTERISTICS (continued)

NOISE VOLTAGE
(REFERRED TO INPUT)
OVER A 10-SECOND INTERVAL

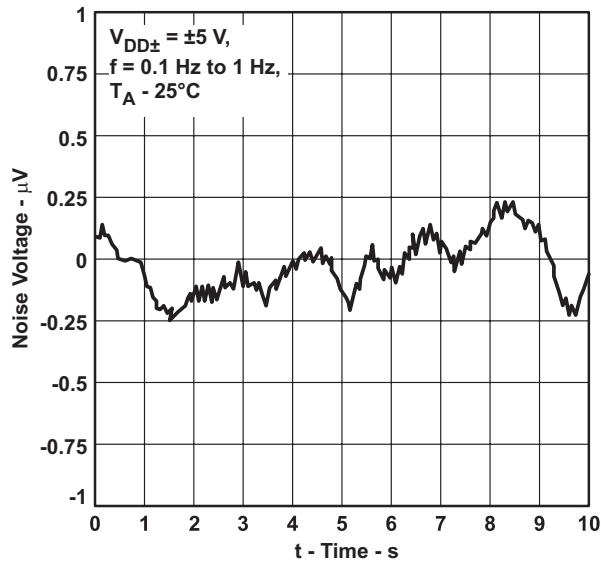

Figure 29.

NOISE VOLTAGE
(REFERRED TO INPUT)
OVER A 10-SECOND INTERVAL

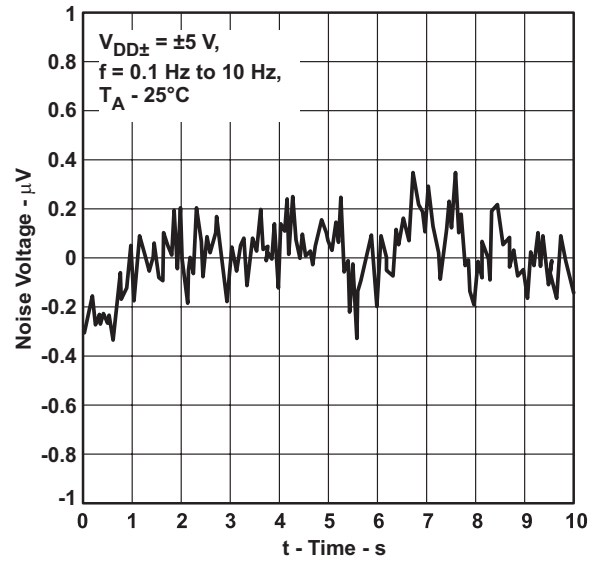

Figure 30.

GAIN-BANDWIDTH PRODUCT
vs
SUPPLY VOLTAGE

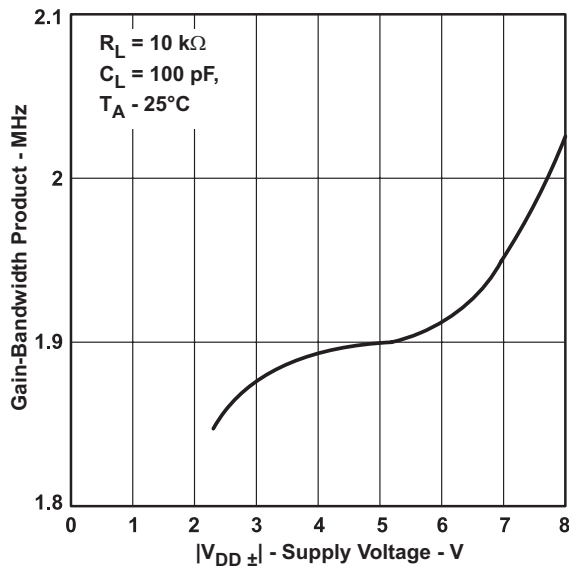

Figure 31.

GAIN-BANDWIDTH PRODUCT
vs
FREE-AIR TEMPERATURE

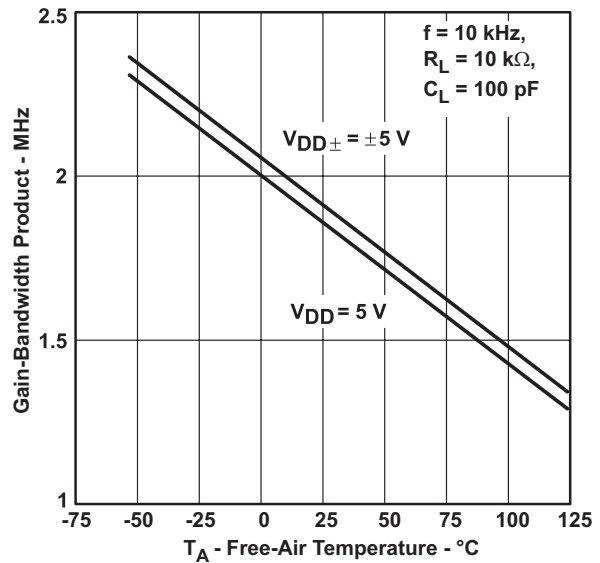
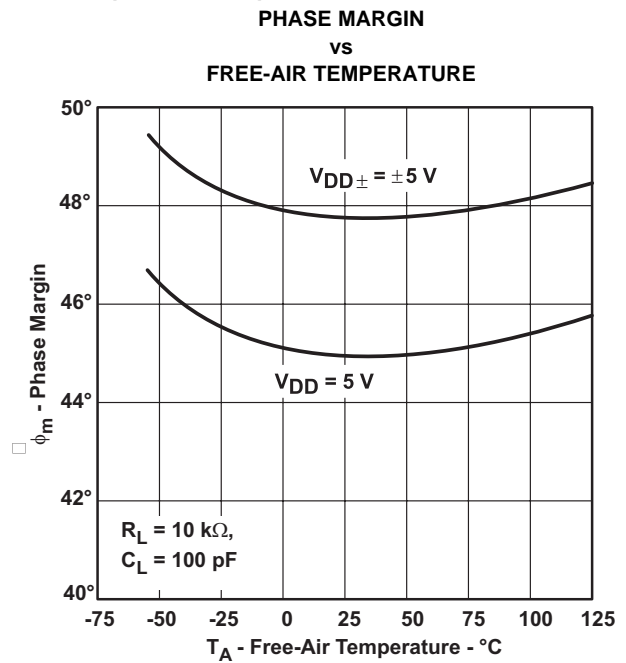
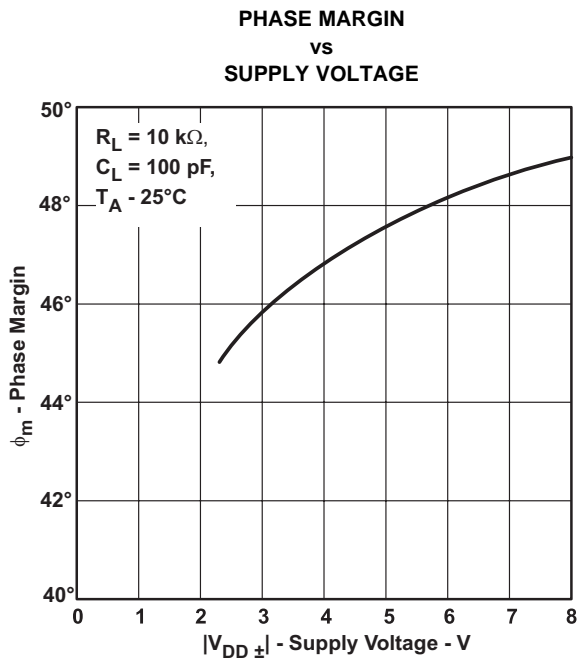

Figure 32.

TYPICAL CHARACTERISTICS (continued)



APPLICATION INFORMATION

LATCH-UP AVOIDANCE

Because CMOS devices are susceptible to latch-up due to their inherent parasitic thyristors, the TLC2201 inputs and outputs are designed to withstand –100-mA surge currents without sustaining latch-up; however, techniques reducing the chance of latch-up should be used whenever possible. Internal protection diodes should not be forward biased in normal operation. Applied input and output voltages should not exceed the supply voltage by more than 300 mV. Care should be exercised when using capacitive coupling on pulse generators. Supply transients should be shunted by the use of decoupling capacitors (0.1 μ F typical) located across the supply rails as close to the device as possible.

ELECTROSTATIC DISCHARGE PROTECTION

These devices use internal ESD-protection circuits that prevent functional failures at voltages at or below 2000 V. Care should be exercised in handling these devices as exposure to ESD may result in degradation of the device parametric performance.

MACROMODEL INFORMATION

Macromodel information provided was derived using Microsim Parts™, the model generation software used with Microsim PSpice™. The Boyle macromodel⁽³⁾ and subcircuit in [Figure 35](#) were generated using the TLC2201 typical electrical and operating characteristics at 25°C. Using this information, output simulations of the following key parameters can be generated to a tolerance of 20% (in most cases):

- Maximum positive output voltage swing
- Maximum negative output voltage swing
- Slew rate
- Quiescent power dissipation
- Input bias current
- Open-loop voltage amplification
- Unity-gain frequency
- Common-mode rejection ratio
- Phase margin
- DC output resistance
- AC output resistance
- Short-circuit output current limit

(3) G. R. Boyle, B. M. Cohn, D. O. Pederson, and J. E. Solomon, "Macromodeling of Integrated Circuit Operational Amplifiers", IEEE Journal of Solid-State Circuits, SC-9, 353 (1974).

PACKAGING INFORMATION

Orderable Device	Status ⁽¹⁾	Package Type	Package Drawing	Pins	Package Qty	Eco Plan ⁽²⁾	Lead/ Ball Finish	MSL Peak Temp ⁽³⁾	Samples (Requires Login)
5962-9088203V2A	ACTIVE	LCCC	FK	20	1	TBD	POST-PLATE	N / A for Pkg Type	

⁽¹⁾ The marketing status values are defined as follows:

ACTIVE: Product device recommended for new designs.

LIFEBUY: TI has announced that the device will be discontinued, and a lifetime-buy period is in effect.

NRND: Not recommended for new designs. Device is in production to support existing customers, but TI does not recommend using this part in a new design.

PREVIEW: Device has been announced but is not in production. Samples may or may not be available.

OBSOLETE: TI has discontinued the production of the device.

⁽²⁾ Eco Plan - The planned eco-friendly classification: Pb-Free (RoHS), Pb-Free (RoHS Exempt), or Green (RoHS & no Sb/Br) - please check <http://www.ti.com/productcontent> for the latest availability information and additional product content details.

TBD: The Pb-Free/Green conversion plan has not been defined.

Pb-Free (RoHS): TI's terms "Lead-Free" or "Pb-Free" mean semiconductor products that are compatible with the current RoHS requirements for all 6 substances, including the requirement that lead not exceed 0.1% by weight in homogeneous materials. Where designed to be soldered at high temperatures, TI Pb-Free products are suitable for use in specified lead-free processes.

Pb-Free (RoHS Exempt): This component has a RoHS exemption for either 1) lead-based flip-chip solder bumps used between the die and package, or 2) lead-based die adhesive used between the die and leadframe. The component is otherwise considered Pb-Free (RoHS compatible) as defined above.

Green (RoHS & no Sb/Br): TI defines "Green" to mean Pb-Free (RoHS compatible), and free of Bromine (Br) and Antimony (Sb) based flame retardants (Br or Sb do not exceed 0.1% by weight in homogeneous material)

⁽³⁾ MSL, Peak Temp. -- The Moisture Sensitivity Level rating according to the JEDEC industry standard classifications, and peak solder temperature.

Important Information and Disclaimer: The information provided on this page represents TI's knowledge and belief as of the date that it is provided. TI bases its knowledge and belief on information provided by third parties, and makes no representation or warranty as to the accuracy of such information. Efforts are underway to better integrate information from third parties. TI has taken and continues to take reasonable steps to provide representative and accurate information but may not have conducted destructive testing or chemical analysis on incoming materials and chemicals. TI and TI suppliers consider certain information to be proprietary, and thus CAS numbers and other limited information may not be available for release.

In no event shall TI's liability arising out of such information exceed the total purchase price of the TI part(s) at issue in this document sold by TI to Customer on an annual basis.

OTHER QUALIFIED VERSIONS OF TLC2201-SP :

● Catalog: [TLC2201](#)

● Military: [TLC2201M](#)

NOTE: Qualified Version Definitions:

- Catalog - TI's standard catalog product
- Military - QML certified for Military and Defense Applications

FK (S-CQCC-N**)

LEADLESS CERAMIC CHIP CARRIER

28 TERMINAL SHOWN

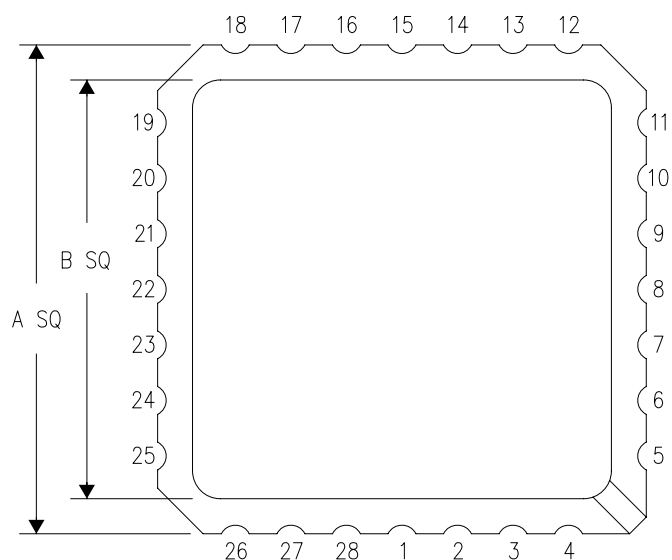

NO. OF TERMINALS **	A		B	
	MIN	MAX	MIN	MAX
20	0.342 (8,69)	0.358 (9,09)	0.307 (7,80)	0.358 (9,09)
28	0.442 (11,23)	0.458 (11,63)	0.406 (10,31)	0.458 (11,63)
44	0.640 (16,26)	0.660 (16,76)	0.495 (12,58)	0.560 (14,22)
52	0.740 (18,78)	0.761 (19,32)	0.495 (12,58)	0.560 (14,22)
68	0.938 (23,83)	0.962 (24,43)	0.850 (21,6)	0.858 (21,8)
84	1.141 (28,99)	1.165 (29,59)	1.047 (26,6)	1.063 (27,0)

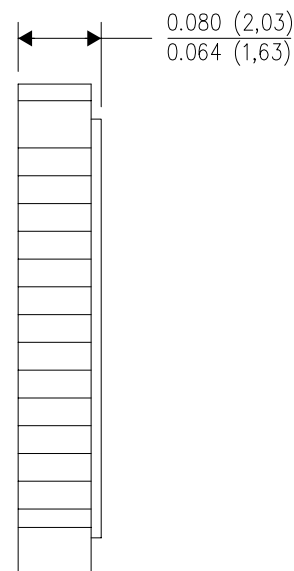
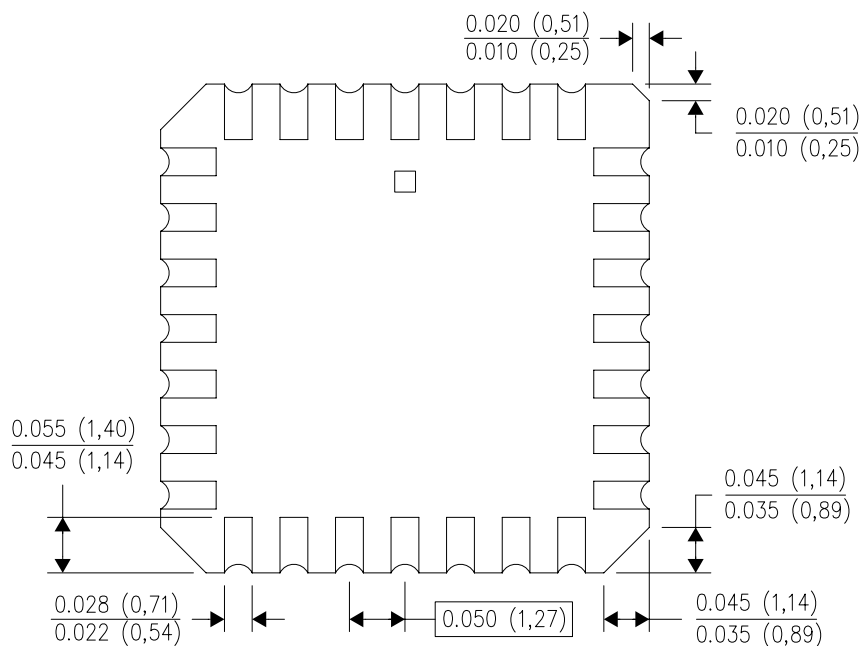

4040140/D 01/11

- NOTES:
- A. All linear dimensions are in inches (millimeters).
 - B. This drawing is subject to change without notice.
 - C. This package can be hermetically sealed with a metal lid.
 - D. Falls within JEDEC MS-004

IMPORTANT NOTICE

Texas Instruments Incorporated and its subsidiaries (TI) reserve the right to make corrections, modifications, enhancements, improvements, and other changes to its products and services at any time and to discontinue any product or service without notice. Customers should obtain the latest relevant information before placing orders and should verify that such information is current and complete. All products are sold subject to TI's terms and conditions of sale supplied at the time of order acknowledgment.

TI warrants performance of its hardware products to the specifications applicable at the time of sale in accordance with TI's standard warranty. Testing and other quality control techniques are used to the extent TI deems necessary to support this warranty. Except where mandated by government requirements, testing of all parameters of each product is not necessarily performed.

TI assumes no liability for applications assistance or customer product design. Customers are responsible for their products and applications using TI components. To minimize the risks associated with customer products and applications, customers should provide adequate design and operating safeguards.

TI does not warrant or represent that any license, either express or implied, is granted under any TI patent right, copyright, mask work right, or other TI intellectual property right relating to any combination, machine, or process in which TI products or services are used. Information published by TI regarding third-party products or services does not constitute a license from TI to use such products or services or a warranty or endorsement thereof. Use of such information may require a license from a third party under the patents or other intellectual property of the third party, or a license from TI under the patents or other intellectual property of TI.

Reproduction of TI information in TI data books or data sheets is permissible only if reproduction is without alteration and is accompanied by all associated warranties, conditions, limitations, and notices. Reproduction of this information with alteration is an unfair and deceptive business practice. TI is not responsible or liable for such altered documentation. Information of third parties may be subject to additional restrictions.

Resale of TI products or services with statements different from or beyond the parameters stated by TI for that product or service voids all express and any implied warranties for the associated TI product or service and is an unfair and deceptive business practice. TI is not responsible or liable for any such statements.

TI products are not authorized for use in safety-critical applications (such as life support) where a failure of the TI product would reasonably be expected to cause severe personal injury or death, unless officers of the parties have executed an agreement specifically governing such use. Buyers represent that they have all necessary expertise in the safety and regulatory ramifications of their applications, and acknowledge and agree that they are solely responsible for all legal, regulatory and safety-related requirements concerning their products and any use of TI products in such safety-critical applications, notwithstanding any applications-related information or support that may be provided by TI. Further, Buyers must fully indemnify TI and its representatives against any damages arising out of the use of TI products in such safety-critical applications.

TI products are neither designed nor intended for use in military/aerospace applications or environments unless the TI products are specifically designated by TI as military-grade or "enhanced plastic." Only products designated by TI as military-grade meet military specifications. Buyers acknowledge and agree that any such use of TI products which TI has not designated as military-grade is solely at the Buyer's risk, and that they are solely responsible for compliance with all legal and regulatory requirements in connection with such use.

TI products are neither designed nor intended for use in automotive applications or environments unless the specific TI products are designated by TI as compliant with ISO/TS 16949 requirements. Buyers acknowledge and agree that, if they use any non-designated products in automotive applications, TI will not be responsible for any failure to meet such requirements.

Following are URLs where you can obtain information on other Texas Instruments products and application solutions:

Products

Audio	www.ti.com/audio
Amplifiers	amplifier.ti.com
Data Converters	dataconverter.ti.com
DLP® Products	www.dlp.com
DSP	dsp.ti.com
Clocks and Timers	www.ti.com/clocks
Interface	interface.ti.com
Logic	logic.ti.com
Power Mgmt	power.ti.com
Microcontrollers	microcontroller.ti.com
RFID	www.ti-rfid.com
RF/IF and ZigBee® Solutions	www.ti.com/lprf

Applications

Communications and Telecom	www.ti.com/communications
Computers and Peripherals	www.ti.com/computers
Consumer Electronics	www.ti.com/consumer-apps
Energy and Lighting	www.ti.com/energy
Industrial	www.ti.com/industrial
Medical	www.ti.com/medical
Security	www.ti.com/security
Space, Avionics and Defense	www.ti.com/space-avionics-defense
Transportation and Automotive	www.ti.com/automotive
Video and Imaging	www.ti.com/video
Wireless	www.ti.com/wireless-apps

TI E2E Community Home Page

e2e.ti.com

Mailing Address: Texas Instruments, Post Office Box 655303, Dallas, Texas 75265
Copyright © 2011, Texas Instruments Incorporated