

# TLC227x, TLC227xA Advanced LinCMOS™ RAIL-TO-RAIL OPERATIONAL AMPLIFIERS

SLOS190B – FEBRUARY 1997 – REVISED JULY 1999

- Output Swing Includes Both Supply Rails
- Low Noise . . . 9 nV/√Hz Typ at f = 1 kHz
- Low Input Bias Current . . . 1 pA Typ
- Fully Specified for Both Single-Supply and Split-Supply Operation
- Common-Mode Input Voltage Range Includes Negative Rail
- High-Gain Bandwidth . . . 2.2 MHz Typ
- High Slew Rate . . . 3.6 V/μs Typ
- Low Input Offset Voltage  
950 μV Max at T<sub>A</sub> = 25°C
- Macromodel Included
- Performance Upgrades for the TS272, TS274, TLC272, and TLC274
- Available in Q-Temp Automotive HighRel Automotive Applications Configuration Control / Print Support Qualification to Automotive Standards

## description

The TLC2272 and TLC2274 are dual and quadruple operational amplifiers from Texas Instruments. Both devices exhibit rail-to-rail output performance for increased dynamic range in single- or split-supply applications. The TLC227x family offers 2 MHz of bandwidth and 3 V/μs of slew rate for higher speed applications. These devices offer comparable ac performance while having better noise, input offset voltage, and power dissipation than existing CMOS operational amplifiers. The TLC227x has a noise voltage of 9 nV/√Hz, two times lower than competitive solutions.

The TLC227x, exhibiting high input impedance and low noise, is excellent for small-signal conditioning for high-impedance sources, such as piezoelectric transducers. Because of the micro-power dissipation levels, these devices work well in hand-held monitoring and remote-sensing applications. In addition, the rail-to-rail output feature, with single- or split-supplies, makes this family a great choice when interfacing with analog-to-digital converters (ADCs). For precision applications, the TLC227xA family is available and has a maximum input offset voltage of 950 μV. This family is fully characterized at 5 V and ±5 V.

The TLC2272/4 also makes great upgrades to the TLC272/4 or TS272/4 in standard designs. They offer increased output dynamic range, lower noise voltage, and lower input offset voltage. This enhanced feature set allows them to be used in a wider range of applications. For applications that require higher output drive and wider input voltage range, see the TLV2432 and TLV2442 devices.

If the design requires single amplifiers, please see the TLV2211/21/31 family. These devices are single rail-to-rail operational amplifiers in the SOT-23 package. Their small size and low power consumption, make them ideal for high density, battery-powered equipment.

MAXIMUM PEAK-TO-PEAK OUTPUT VOLTAGE  
vs  
SUPPLY VOLTAGE

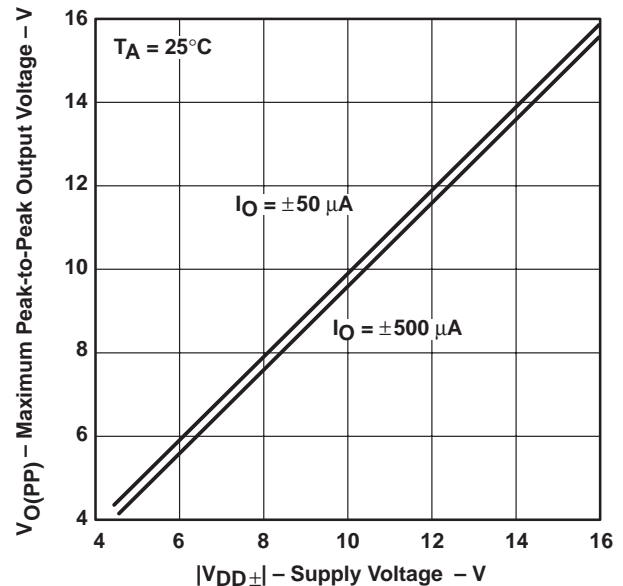

Please be aware that an important notice concerning availability, standard warranty, and use in critical applications of Texas Instruments semiconductor products and disclaimers thereto appears at the end of this data sheet.

Advanced LinCMOS is a trademark of Texas Instruments Incorporated.

PRODUCTION DATA information is current as of publication date. Products conform to specifications per the terms of Texas Instruments standard warranty. Production processing does not necessarily include testing of all parameters.

 **TEXAS  
INSTRUMENTS**

POST OFFICE BOX 655303 • DALLAS, TEXAS 75265

Copyright © 1999, Texas Instruments Incorporated  
On products compliant to MIL-PRF-38535, all parameters are tested unless otherwise noted. On all other products, production processing does not necessarily include testing of all parameters.

# TLC227x, TLC227xA

## Advanced LinCMOS™ RAIL-TO-RAIL

### OPERATIONAL AMPLIFIERS

SLOS190B – FEBRUARY 1997 – REVISED JULY 1999

#### TLC2272 AVAILABLE OPTIONS

T <sub>A</sub>	V <sub>IO</sub> max At 25°C	PACKAGED DEVICES		
		SMALL OUTLINE† (D)	PLASTIC DIP (P)	TSSOP‡ (PW)
0°C to 70°C	950 µV 2.5 mV	TLC2272ACD TLC2272CD	TLC2272ACP TLC2272CP	TLC2272CPW
-40°C to 85°C	950 µV 2.5 mV	TLC2272AID TLC2272ID	TLC2272AIP TLC2272IP	—
-40°C to 125°C	950 µV 2.5 mV	TLC2272AQD TLC2272QD	—	TLC2272AQPW TLC2272QPW
-55°C to 125°C	950 µV 2.5 mV	TLC2272AMD TLC2272MD	TLC2272AMP TLC2272MP	—

† The D packages are available taped and reeled. Add R suffix to the device type (e.g., TLC2272CDR).

‡ The PW package is available taped and reeled. Add R suffix to the device type (e.g., TLC2272PWR).

§ Chips are tested at 25°C.

#### TLC2274 AVAILABLE OPTIONS

T <sub>A</sub>	V <sub>IO</sub> max AT 25°C	PACKAGED DEVICES				
		SMALL OUTLINE† (D)	CHIP CARRIER (FK)	CERAMIC DIP (J)	PLASTIC DIP (N)	TSSOP‡ (PW)
0°C to 70°C	950 µV 2.5 mV	TLC2274ACD TLC2274CD	—	—	TLC2274ACN TLC2274CN	— TLC2274CPW
-40°C to 85°C	950 µV 2.5 mV	TLC2274AID TLC2274ID	—	—	TLC2274AIN TLC2274IN	— TLC2274IPW
-40°C to 125°C	950 µV 2.5 mV	TLC2274AQD TLC2274QD	—	—	—	—
-55°C to 125°C	950 µV 2.5 mV	TLC2274AMD TLC2274MD	TLC2274AMFK TLC2274MFK	TLC2274AMJ TLC2274MJ	TLC2274AMN TLC2274MN	—

† The D packages are available taped and reeled. Add R suffix to device type (e.g., TLC2274CDR).

‡ The PW package is available taped and reeled.

§ Chips are tested at 25°C.

**TLC2272**  
D, P, OR PW PACKAGE  
(TOP VIEW)

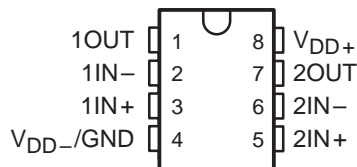

**TLC2274**  
D, J, N, OR PW PACKAGE  
(TOP VIEW)

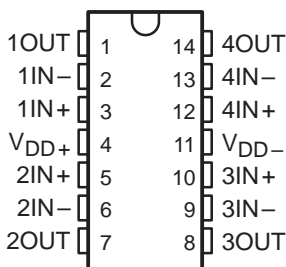

**TLC2274**  
FK PACKAGE  
(TOP VIEW)

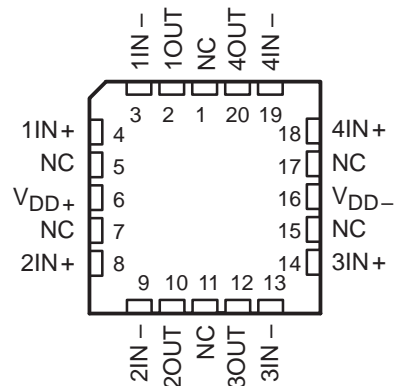

NC – No internal connection

equivalent schematic (each amplifier)

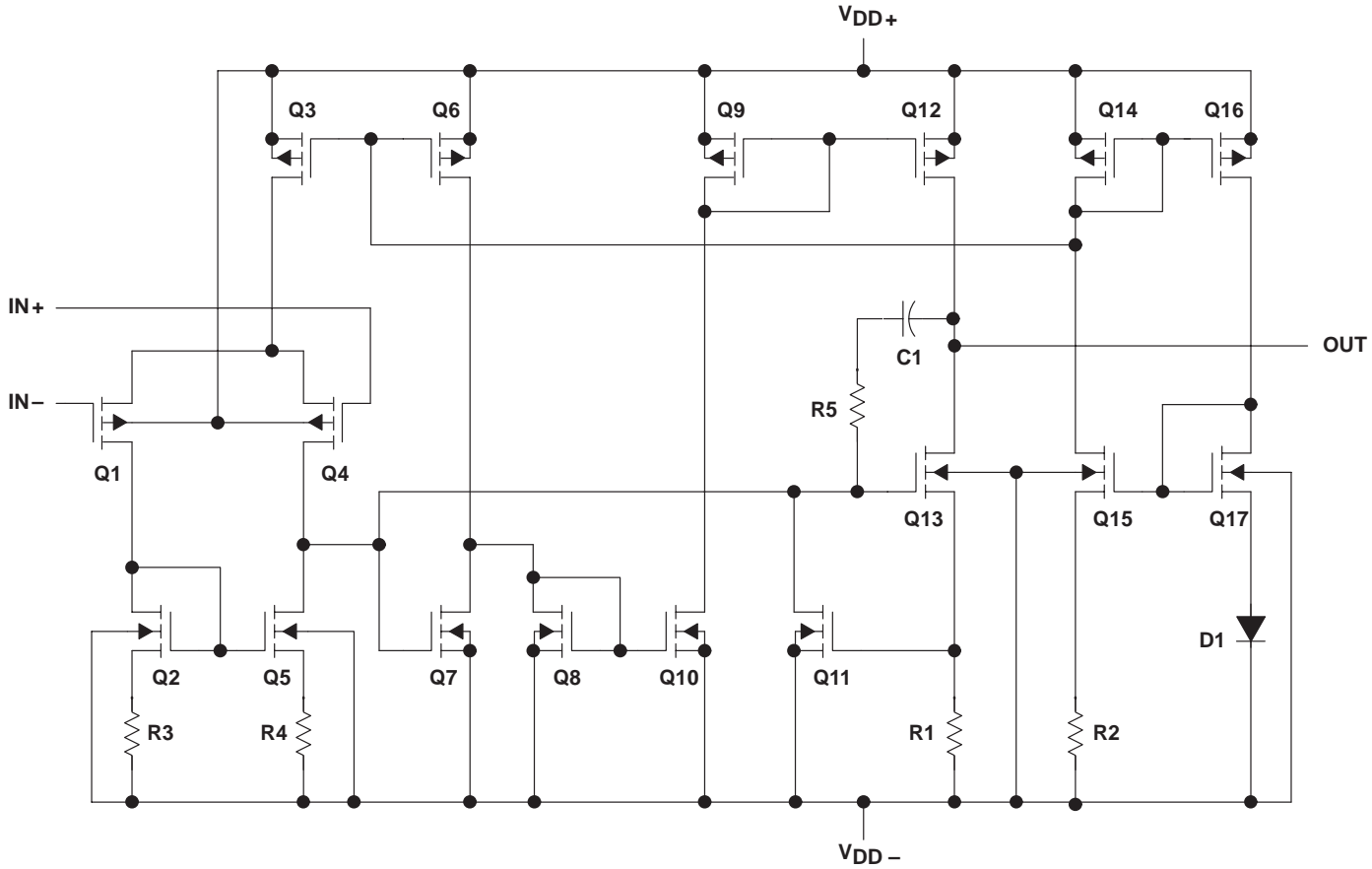

ACTUAL DEVICE COMPONENT COUNT†		
COMPONENT	TLC2272	TLC2274
Transistors	38	76
Resistors	26	52
Diodes	9	18
Capacitors	3	6

† Includes both amplifiers and all ESD, bias, and trim circuitry

# TLC227x, TLC227xA

## Advanced LinCMOS™ RAIL-TO-RAIL OPERATIONAL AMPLIFIERS

SLOS190B – FEBRUARY 1997 – REVISED JULY 1999

### absolute maximum ratings over operating free-air temperature range (unless otherwise noted)†

Supply voltage, $V_{DD+}$ (see Note 1)	8 V
Supply voltage, $V_{DD-}$ (see Note 1)	–8 V
Differential input voltage, $V_{ID}$ (see Note 2)	±16 V
Input voltage, $V_I$ (any input, see Note 1)	$V_{DD-} - 0.3 \text{ V}$ to $V_{DD+}$
Input current, $I_I$ (any input)	±5 mA
Output current, $I_O$	±50 mA
Total current into $V_{DD+}$	±50 mA
Total current out of $V_{DD-}$	±50 mA
Duration of short-circuit current at (or below) 25°C (see Note 3)	unlimited
Continuous total dissipation	See Dissipation Rating Table
Operating free-air temperature range, $T_A$ : C suffix	0°C to 70°C
I suffix	–40°C to 85°C
Q suffix	–40°C to 125°C
M suffix	–55°C to 125°C
Storage temperature range	–65°C to 150°C
Lead temperature 1,6 mm (1/16 inch) from case for 10 seconds: D, N, P or PW package	260°C
Lead temperature 1,6 mm (1/16 inch) from case for 60 seconds: J package	300°C

† Stresses beyond those listed under “absolute maximum ratings” may cause permanent damage to the device. These are stress ratings only, and functional operation of the device at these or any other conditions beyond those indicated under “recommended operating conditions” is not implied. Exposure to absolute-maximum-rated conditions for extended periods may affect device reliability.

- NOTES: 1. All voltage values, except differential voltages, are with respect to the midpoint between  $V_{DD+}$  and  $V_{DD-}$ .  
 2. Differential voltages are at  $IN+$  with respect to  $IN-$ . Excessive current will flow if input is brought below  $V_{DD-} - 0.3 \text{ V}$ .  
 3. The output may be shorted to either supply. Temperature and/or supply voltages must be limited to ensure that the maximum dissipation rating is not exceeded.

DISSIPATION RATING TABLE

PACKAGE	$T_A \leq 25^\circ\text{C}$ POWER RATING	DERATING FACTOR ABOVE $T_A = 25^\circ\text{C}$	$T_A = 70^\circ\text{C}$ POWER RATING	$T_A = 85^\circ\text{C}$ POWER RATING	$T_A = 125^\circ\text{C}$ POWER RATING
D–8	725 mW	5.8 mW/°C	464 mW	337 mW	145 mW
D–14	950 mW	7.6 mW/°C	608 mW	494 mW	190 mW
FK	1375 mW	11.0 mW/°C	880 mW	715 mW	275 mW
J	1375 mW	11.0 mW/°C	880 mW	715 mW	275 mW
N	1150 mW	9.2 mW/°C	736 mW	598 mW	230 mW
P	1000 mW	8.0 mW/°C	640 mW	520 mW	200 mW
PW–8	525 mW	4.2 mW/°C	336 mW	273 mW	105 mW
PW–14	700 mW	5.6 mW/°C	448 mW	364 mW	—

### recommended operating conditions

	C SUFFIX		I SUFFIX		Q SUFFIX		M SUFFIX		UNIT
	MIN	MAX	MIN	MAX	MIN	MAX	MIN	MAX	
Supply voltage, $V_{DD\pm}$	±2.2	±8	±2.2	±8	±2.2	±8	±2.2	±8	V
Input voltage range, $V_I$	$V_{DD-}$	$V_{DD+} - 1.5$	$V_{DD-}$	$V_{DD+} - 1.5$	$V_{DD-}$	$V_{DD+} - 1.5$	$V_{DD-}$	$V_{DD+} - 1.5$	V
Common-mode input voltage, $V_{IC}$	$V_{DD-}$	$V_{DD+} - 1.5$	$V_{DD-}$	$V_{DD+} - 1.5$	$V_{DD-}$	$V_{DD+} - 1.5$	$V_{DD-}$	$V_{DD+} - 1.5$	V
Operating free-air temperature, $T_A$	0	70	–40	85	–40	125	–55	125	°C



**TLC2272C electrical characteristics at specified free-air temperature,  $V_{DD} = 5\text{ V}$  (unless otherwise noted)**

PARAMETER	TEST CONDITIONS	$T_A$ †	TLC2272C			TLC2272AC			UNIT	
			MIN	TYP	MAX	MIN	TYP	MAX		
$V_{IO}$ Input offset voltage		25°C	300		2500	300		950	$\mu\text{V}$	
		Full range	3000			1500				
$\alpha_{VIO}$ Temperature coefficient of input offset voltage		25°C to 70°C	2			2			$\mu\text{V}/^\circ\text{C}$	
Input offset voltage long-term drift (see Note 4)	$V_{IC} = 0,$ $V_O = 0,$	$V_{DD} \pm \pm 2.5\text{ V},$ $R_S = 50\ \Omega$	25°C	0.002			0.002			$\mu\text{V}/\text{mo}$
$I_{IO}$ Input offset current		25°C	0.5			0.5			$\text{pA}$	
		Full range	100			100				
$I_{IB}$ Input bias current		25°C	1			1			$\text{pA}$	
		Full range	100			100				
$V_{ICR}$ Common-mode input voltage range	$R_S = 50\ \Omega,$	$ V_{IO}  \leq 5\text{ mV}$	25°C	0 to 4	-0.3 to 4.2	0 to 4	-0.3 to 4.2	$\text{V}$		
			Full range	0 to 3.5		0 to 3.5				
$V_{OH}$ High-level output voltage	$I_{OH} = -20\ \mu\text{A}$		25°C	4.99		4.99		$\text{V}$		
			25°C	4.85	4.93	4.85	4.93			
			Full range	4.85		4.85				
			25°C	4.25	4.65	4.25	4.65			
$V_{OL}$ Low-level output voltage	$I_{OL} = 50\ \mu\text{A}$		25°C	0.01		0.01		$\text{V}$		
			25°C	0.09	0.15	0.09	0.15			
			Full range	0.15		0.15				
			25°C	0.9	1.5	0.9	1.5			
$V_{OL}$ Low-level output voltage	$I_{OL} = 500\ \mu\text{A}$		25°C	0.01		0.01		$\text{V}$		
			25°C	0.09	0.15	0.09	0.15			
			Full range	0.15		0.15				
			25°C	0.9	1.5	0.9	1.5			
$V_{OL}$ Low-level output voltage	$I_{OL} = 5\text{ mA}$		25°C	0.01		0.01		$\text{V}$		
			25°C	0.09	0.15	0.09	0.15			
			Full range	0.15		0.15				
			25°C	0.9	1.5	0.9	1.5			
$A_{VD}$ Large-signal differential voltage amplification	$V_{IC} = 2.5\text{ V},$ $V_O = 1\text{ V to }4\text{ V}$	$R_L = 10\text{ k}\Omega$ ‡	25°C	15	35	15	35	$\text{V}/\text{mV}$		
			Full range	15		15				
			25°C	175			175			
$r_{id}$ Differential input resistance			25°C	$10^{12}$			$10^{12}$			$\Omega$
			25°C	$10^{12}$			$10^{12}$			$\Omega$
$r_i$ Common-mode input resistance			25°C	$10^{12}$			$10^{12}$			$\Omega$
$c_i$ Common-mode input capacitance	$f = 10\text{ kHz},$	P package	25°C	8			8			$\text{pF}$
$z_o$ Closed-loop output impedance	$f = 1\text{ MHz},$	$A_V = 10$	25°C	140			140			$\Omega$
CMRR Common-mode rejection ratio	$V_{IC} = 0\text{ to }2.7\text{ V},$ $V_O = 2.5\text{ V},$	$R_S = 50\ \Omega$	25°C	70	75	70	75	$\text{dB}$		
			Full range	70			70			
$k_{SVR}$ Supply-voltage rejection ratio ( $\Delta V_{DD}/\Delta V_{IO}$ )	$V_{DD} = 4.4\text{ V to }16\text{ V},$ $V_{IC} = V_{DD}/2,$	No load	25°C	80	95	80	95	$\text{dB}$		
			Full range	80			80			
$I_{DD}$ Supply current	$V_O = 2.5\text{ V},$	No load	25°C	2.2	3	2.2	3	$\text{mA}$		
			Full range	3			3			

† Full range is 0°C to 70°C.

‡ Referenced to 2.5 V

NOTE 4: Typical values are based on the input offset voltage shift observed through 168 hours of operating life test at  $T_A = 150^\circ\text{C}$  extrapolated to  $T_A = 25^\circ\text{C}$  using the Arrhenius equation and assuming an activation energy of 0.96 eV.

**TLC227x, TLC227xA**  
**Advanced LinCMOS™ RAIL-TO-RAIL**  
**OPERATIONAL AMPLIFIERS**

SLOS190B – FEBRUARY 1997 – REVISED JULY 1999

**TLC2272C operating characteristics at specified free-air temperature,  $V_{DD} = 5\text{ V}$**

PARAMETER	TEST CONDITIONS	$T_A$ †	TLC2272C			TLC2272AC			UNIT	
			MIN	TYP	MAX	MIN	TYP	MAX		
SR	Slew rate at unity gain	$V_O = 0.5\text{ V to }2.5\text{ V}$ , $R_L = 10\text{ k}\Omega$ ‡, $C_L = 100\text{ pF}$ ‡	25°C	2.3	3.6		2.3	3.6	V/ $\mu$ s	
			Full range	1.7			1.7			
$V_n$	Equivalent input noise voltage	$f = 10\text{ Hz}$	25°C		50			50	nV/ $\sqrt{\text{Hz}}$	
			$f = 1\text{ kHz}$	25°C		9				9
$V_{NPP}$	Peak-to-peak equivalent input noise voltage	$f = 0.1\text{ Hz to }1\text{ Hz}$	25°C		1			1	$\mu$ V	
			$f = 0.1\text{ Hz to }10\text{ Hz}$	25°C		1.4				1.4
$I_n$	Equivalent input noise current		25°C		0.6			0.6	fA/ $\sqrt{\text{Hz}}$	
THD + N	Total harmonic distortion plus noise	$V_O = 0.5\text{ V to }2.5\text{ V}$ , $f = 20\text{ kHz}$ , $R_L = 10\text{ k}\Omega$ ‡	25°C	$A_V = 1$		0.0013%		0.0013%		
				$A_V = 10$		0.004%		0.004%		
				$A_V = 100$		0.03%		0.03%		
	Gain-bandwidth product	$f = 10\text{ kHz}$ , $R_L = 10\text{ k}\Omega$ ‡, $C_L = 100\text{ pF}$ ‡	25°C		2.18			2.18	MHz	
BOM	Maximum output-swing bandwidth	$V_{O(PP)} = 2\text{ V}$ , $R_L = 10\text{ k}\Omega$ ‡, $A_V = 1$ , $C_L = 100\text{ pF}$ ‡	25°C		1			1	MHz	
$t_s$	Settling time	$A_V = -1$ , Step = 0.5 V to 2.5 V, $R_L = 10\text{ k}\Omega$ ‡, $C_L = 100\text{ pF}$ ‡	25°C	To 0.1%		1.5			1.5	$\mu$ s
				To 0.01%		2.6			2.6	
$\phi_m$	Phase margin at unity gain	$R_L = 10\text{ k}\Omega$ ‡, $C_L = 100\text{ pF}$ ‡	25°C		50°			50°		
	Gain margin		25°C		10			10	dB	

† Full range is 0°C to 70°C.

‡ Referenced to 2.5 V



**TLC227x, TLC227xA**  
**Advanced LinCMOS™ RAIL-TO-RAIL**  
**OPERATIONAL AMPLIFIERS**

SLOS190B – FEBRUARY 1997 – REVISED JULY 1999

**TLC2272C electrical characteristics at specified free-air temperature,  $V_{DD\pm} = \pm 5\text{ V}$  (unless otherwise specified)**

PARAMETER	TEST CONDITIONS	$T_A$ †	TLC2272C			TLC2272AC			UNIT	
			MIN	TYP	MAX	MIN	TYP	MAX		
$V_{IO}$ Input offset voltage		25°C	300 2500			300 950			$\mu\text{V}$	
		Full range	3000			1500				
$\alpha_{VIO}$ Temperature coefficient of input offset voltage		25°C to 70°C	2			2			$\mu\text{V}/^\circ\text{C}$	
Input offset voltage long-term drift (see Note 4)	$V_{IC} = 0, R_S = 50\ \Omega, V_O = 0,$	25°C	0.002			0.002			$\mu\text{V}/\text{mo}$	
$I_{IO}$ Input offset current		25°C	0.5			0.5			$\text{pA}$	
		Full range	100			100				
$I_{IB}$ Input bias current		25°C	1			1			$\text{pA}$	
		Full range	100			100				
$V_{ICR}$ Common-mode input voltage range	$R_S = 50\ \Omega,  V_{IO}  \leq 5\ \text{mV}$	25°C	-5 to 4 -5.3 to 4.2			-5 to 4 -5.3 to 4.2			$\text{V}$	
		Full range	-5 to 3.5			-5 to 3.5				
$V_{OM+}$ Maximum positive peak output voltage	$I_O = -20\ \mu\text{A}$	25°C	4.99			4.99			$\text{V}$	
		25°C	4.85 4.93			4.85 4.93				
		Full range	4.85			4.85				
		25°C	4.25 4.65			4.25 4.65				
$V_{OM-}$ Maximum negative peak output voltage	$I_O = -1\ \text{mA}$	25°C	-4.99			-4.99			$\text{V}$	
		25°C	-4.85 -4.91			-4.85 -4.91				
		Full range	-4.85			-4.85				
		25°C	-3.5 -4.1			-3.5 -4.1				
$A_{VD}$ Large-signal differential voltage amplification	$V_O = \pm 4\ \text{V}$	$R_L = 10\ \text{k}\Omega$	25°C	25 50		25 50		$\text{V}/\text{mV}$		
			Full range	25		25				
		$R_L = 1\ \text{m}\Omega$	25°C	300			300			
			Full range	300			300			
$r_{id}$ Differential input resistance		25°C	$10^{12}$			$10^{12}$			$\Omega$	
$r_i$ Common-mode input resistance		25°C	$10^{12}$			$10^{12}$			$\Omega$	
$c_i$ Common-mode input capacitance	$f = 10\ \text{kHz}, \text{ P package}$	25°C	8			8			$\text{pF}$	
$z_o$ Closed-loop output impedance	$f = 1\ \text{MHz}, A_V = 10$	25°C	130			130			$\Omega$	
CMRR Common-mode rejection ratio	$V_{IC} = -5\ \text{to}\ 2.7\ \text{V}, V_O = 0\ \text{V}, R_S = 50\ \Omega$	25°C	75 80			75 80			dB	
		Full range	75			75				
$k_{SVR}$ Supply-voltage rejection ratio ( $\Delta V_{DD\pm} / \Delta V_{IO}$ )	$V_{DD\pm} = 2.2\ \text{V to}\ \pm 8\ \text{V}, V_{IC} = 0, \text{ No load}$	25°C	80 95			80 95			dB	
		Full range	80			80				
$I_{DD}$ Supply current	$V_O = 0\ \text{V}$ No load	25°C	2.4 3			2.4 3			$\text{mA}$	
		Full range	3			3				

† Full range is 0°C to 70°C.

NOTE 4: Typical values are based on the input offset voltage shift observed through 168 hours of operating life test at  $T_A = 150^\circ\text{C}$  extrapolated to  $T_A = 25^\circ\text{C}$  using the Arrhenius equation and assuming an activation energy of 0.96 eV.



**TLC227x, TLC227xA**  
**Advanced LinCMOS™ RAIL-TO-RAIL**  
**OPERATIONAL AMPLIFIERS**

SLOS190B – FEBRUARY 1997 – REVISED JULY 1999

**TLC2272C operating characteristics at specified free-air temperature,  $V_{DD\pm} = \pm 5\text{ V}$**

PARAMETER	TEST CONDITIONS	$T_A$ †	TLC2272C			TLC2272AC			UNIT
			MIN	TYP	MAX	MIN	TYP	MAX	
SR	Slew rate at unity gain $V_O = \pm 2.3\text{ V}$ , $C_L = 100\text{ pF}$ $R_L = 10\text{ k}\Omega$	25°C	2.3	3.6		2.3	3.6	V/ $\mu$ s	
		Full range	1.7			1.7			
$V_n$	Equivalent input noise voltage $f = 10\text{ Hz}$ $f = 1\text{ kHz}$	25°C		50			50	nV/ $\sqrt{\text{Hz}}$	
		25°C		9			9		
$V_{NPP}$	Peak-to-peak equivalent input noise voltage $f = 0.1\text{ Hz to }1\text{ Hz}$ $f = 0.1\text{ Hz to }10\text{ Hz}$	25°C		1			1	$\mu$ V	
		25°C		1.4			1.4		
$I_n$	Equivalent input noise current	25°C		0.6			0.6	fA/ $\sqrt{\text{Hz}}$	
THD + N	Total harmonic distortion pulse duration $V_O = \pm 2.3\text{ V}$ , $f = 20\text{ kHz}$ , $R_L = 10\text{ k}\Omega$	$A_V = 1$ $A_V = 10$ $A_V = 100$	25°C		0.0011%		0.0011%		
					0.004%		0.004%		
					0.03%		0.03%		
	Gain-bandwidth product $f = 10\text{ kHz}$ , $C_L = 100\text{ pF}$ $R_L = 10\text{ k}\Omega$	25°C		2.25			2.25	MHz	
$B_{OM}$	Maximum output-swing bandwidth $V_{O(PP)} = 4.6\text{ V}$ , $R_L = 10\text{ k}\Omega$ , $A_V = 1$ , $C_L = 100\text{ pF}$	25°C		0.54			0.54	MHz	
$t_s$	Settling time $A_V = -1$ , Step = $-2.3\text{ V to }2.3\text{ V}$ , $R_L = 10\text{ k}\Omega$ , $C_L = 100\text{ pF}$	To 0.1%	25°C		1.5		1.5	$\mu$ s	
		To 0.01%			3.2		3.2		
$\phi_m$	Phase margin at unity gain $R_L = 10\text{ k}\Omega$ , $C_L = 100\text{ pF}$	25°C		52°			52°		
		25°C		10			10	dB	

† Full range is 0°C to 70°C.





**TLC2274C electrical characteristics at specified free-air temperature,  $V_{DD} = 5\text{ V}$  (unless otherwise noted)**

PARAMETER	TEST CONDITIONS	$T_A$ †	TLC2274C			TLC2274AC			UNIT	
			MIN	TYP	MAX	MIN	TYP	MAX		
$V_{IO}$ Input offset voltage	$V_{DD\pm} = \pm 2.5\text{ V}$ , $V_{IC} = 0$ , $V_O = 0$ , $R_S = 50\ \Omega$	25°C	300	2500		300	950	$\mu\text{V}$		
		Full range	3000			1500				
$\alpha_{VIO}$ Temperature coefficient of input offset voltage		25°C to 70°C	2			2			$\mu\text{V}/^\circ\text{C}$	
Input offset voltage long-term drift (see Note 4)		25°C	0.002			0.002			$\mu\text{V}/\text{mo}$	
$I_{IO}$ Input offset current		25°C	0.5			0.5			$\text{pA}$	
		Full range	100			100				
$I_{IB}$ Input bias current	25°C	1			1			$\text{pA}$		
	Full range	100			100					
$V_{ICR}$ Common-mode input voltage range	$R_S = 50\ \Omega$ , $ V_{IO}  \leq 5\text{ mV}$	25°C	0 to 4	-0.3 to 4.2		0 to 4	-0.3 to 4.2	V		
		Full range	0 to 3.5		0 to 3.5					
$V_{OH}$ High-level output voltage	$I_{OH} = -20\ \mu\text{A}$	25°C	4.99			4.99			V	
		25°C	4.85	4.93		4.85	4.93			
		Full range	4.85			4.85				
		25°C	4.25	4.65		4.25	4.65			
$V_{OL}$ Low-level output voltage	$V_{IC} = 2.5\text{ V}$ , $I_{OL} = 50\ \mu\text{A}$	25°C	0.01			0.01			V	
		25°C	0.09	0.15		0.09	0.15			
		Full range	0.15			0.15				
		25°C	0.9	1.5		0.9	1.5			
$A_{VD}$ Large-signal differential voltage amplification	$V_{IC} = 2.5\text{ V}$ , $V_O = 1\text{ V to }4\text{ V}$	$R_L = 10\text{ k}\Omega$ ‡	25°C	15	35		15	35	V/mV	
			Full range	15			15			
		$R_L = 1\text{ m}\Omega$ ‡	25°C	175			175			
			Full range	175			175			
$r_{id}$ Differential input resistance		25°C	$10^{12}$			$10^{12}$			$\Omega$	
$r_i$ Common-mode input resistance		25°C	$10^{12}$			$10^{12}$			$\Omega$	
$c_i$ Common-mode input capacitance	$f = 10\text{ kHz}$ , N package	25°C	8			8			$\text{pF}$	
$z_o$ Closed-loop output impedance	$f = 1\text{ MHz}$ , $A_V = 10$	25°C	140			140			$\Omega$	
CMRR Common-mode rejection ratio	$V_{IC} = 0\text{ to }2.7\text{ V}$ , $V_O = 2.5\text{ V}$ , $R_S = 50\ \Omega$	25°C	70	75		70	75	dB		
		Full range	70			70				
$k_{SVR}$ Supply-voltage rejection ratio ( $\Delta V_{DD}/\Delta V_{IO}$ )	$V_{DD} = 4.4\text{ V to }16\text{ V}$ , $V_{IC} = V_{DD}/2$ , No load	25°C	80	95		80	95	dB		
		Full range	80			80				
$I_{DD}$ Supply current	$V_O = 2.5\text{ V}$ , No load	25°C	4.4	6		4.4	6	mA		
		Full range	6			6				

† Full range is 0°C to 70°C.

‡ Referenced to 2.5 V

NOTE 4: Typical values are based on the input offset voltage shift observed through 168 hours of operating life test at  $T_A = 150^\circ\text{C}$  extrapolated to  $T_A = 25^\circ\text{C}$  using the Arrhenius equation and assuming an activation energy of 0.96 eV.

**TLC227x, TLC227xA**  
**Advanced LinCMOS™ RAIL-TO-RAIL**  
**OPERATIONAL AMPLIFIERS**

SLOS190B – FEBRUARY 1997 – REVISED JULY 1999

**TLC2274C operating characteristics at specified free-air temperature,  $V_{DD} = 5\text{ V}$**

PARAMETER	TEST CONDITIONS	$T_A$ †	TLC2274C			TLC2274AC			UNIT	
			MIN	TYP	MAX	MIN	TYP	MAX		
SR	Slew rate at unity gain $V_O = 0.5\text{ V to }2.5\text{ V}$ , $R_L = 10\text{ k}\Omega^\ddagger$ , $C_L = 100\text{ pF}^\ddagger$	25°C	2.3	3.6		2.3	3.6	V/ $\mu\text{s}$		
		Full range	1.7			1.7				
$V_n$	Equivalent input noise voltage	f = 10 Hz	50			50			nV/ $\sqrt{\text{Hz}}$	
		f = 1 kHz	9			9				
$V_N(\text{PP})$	Peak-to-peak equivalent input noise voltage	f = 0.1 to 1 Hz	1			1			$\mu\text{V}$	
		f = 0.1 to 10 Hz	1.4			1.4				
$I_n$	Equivalent input noise current	25°C	0.6			0.6			fA/ $\sqrt{\text{Hz}}$	
THD + N	Total harmonic distortion plus noise $V_O = 0.5\text{ V to }2.5\text{ V}$ , f = 20 kHz, $R_L = 10\text{ k}\Omega^\ddagger$	$A_V = 1$	0.0013%			0.0013%				
		$A_V = 10$	0.004%			0.004%				
		$A_V = 100$	0.03%			0.03%				
	Gain-bandwidth product	f = 10 kHz, $C_L = 100\text{ pF}^\ddagger$	$R_L = 10\text{ k}\Omega^\ddagger$ , 25°C	2.18			2.18			MHz
$B_{OM}$	Maximum output-swing bandwidth	$V_{O(\text{PP})} = 2\text{ V}$ , $R_L = 10\text{ k}\Omega^\ddagger$ , $C_L = 100\text{ pF}^\ddagger$	$A_V = 1$ , $C_L = 100\text{ pF}^\ddagger$ , 25°C	1			1			MHz
$t_s$	Settling time	$A_V = -1$ , Step = 0.5 V to 2.5 V, $R_L = 10\text{ k}\Omega^\ddagger$ , $C_L = 100\text{ pF}^\ddagger$	To 0.1%	1.5			1.5			$\mu\text{s}$
			To 0.01%	2.6			2.6			
$\phi_m$	Phase margin at unity gain	$R_L = 10\text{ k}\Omega^\ddagger$ , $C_L = 100\text{ pF}^\ddagger$	25°C	50°			50°			
	Gain margin		25°C	10			10			

† Full range is 0°C to 70°C.

‡ Referenced to 2.5 V



**TLC2274C electrical characteristics at specified free-air temperature,  $V_{DD\pm} = \pm 5\text{ V}$  (unless otherwise noted)**

PARAMETER	TEST CONDITIONS	$T_A$ †	TLC2274C			TLC2274AC			UNIT	
			MIN	TYP	MAX	MIN	TYP	MAX		
$V_{IO}$ Input offset voltage	$V_{IC} = 0, V_O = 0, R_S = 50\ \Omega$	25°C	300	2500		300	950	$\mu\text{V}$		
		Full range			3000		1500			
$\alpha_{VIO}$ Temperature coefficient of input offset voltage		25°C to 70°C		2			2	$\mu\text{V}/^\circ\text{C}$		
Input offset voltage long-term drift (see Note 4)		25°C		0.002			0.002	$\mu\text{V}/\text{mo}$		
$I_{IO}$ Input offset current		25°C		0.5			0.5	$\text{pA}$		
		Full range			100		100			
$I_{IB}$ Input bias current	25°C		1			1	$\text{pA}$			
	Full range			100		100				
$V_{ICR}$ Common-mode input voltage range	$R_S = 50\ \Omega,  V_{IO}  \leq 5\ \text{mV}$	25°C	-5 to 4	-5.3 to 4.2		-5 to 4	-5.3 to 4.2	V		
		Full range	-5 to 3.5			-5 to 3.5				
$V_{OM+}$ Maximum positive peak output voltage	$I_O = -20\ \mu\text{A}$	25°C		4.99			4.99	V		
		25°C		4.85	4.93		4.85		4.93	
		Full range		4.85			4.85			
		25°C		4.25	4.65		4.25		4.65	
$V_{OM-}$ Maximum negative peak output voltage	$I_O = -1\ \text{mA}$	25°C		-4.9	9		-4.9	9	V	
		25°C		-4.8	-4.9	5	1	-4.8		-4.9
		Full range		-4.8		5		-4.8		5
		25°C		-3.5	-4.1			-3.5		-4.1
$A_{VD}$ Large-signal differential voltage amplification	$V_O = \pm 4\ \text{V}$	$R_L = 10\ \text{k}\Omega$	25°C	25	50		25	50	V/mV	
			Full range	25			25			
$r_{id}$ Differential input resistance			25°C		$10^{12}$			$10^{12}$	$\Omega$	
			Full range		$10^{12}$			$10^{12}$		
$r_i$ Common-mode input resistance			25°C		$10^{12}$			$10^{12}$	$\Omega$	
$c_i$ Common-mode input capacitance	$f = 10\ \text{kHz}, N$ package		25°C		8			8	pF	
$z_o$ Closed-loop output impedance	$f = 1\ \text{MHz}, A_V = 10$		25°C		130			130	$\Omega$	
CMRR Common-mode rejection ratio	$V_{IC} = -5\ \text{V to } 2.7\ \text{V}, V_O = 0, R_S = 50\ \Omega$	25°C		75	80		75	80	dB	
		Full range		75			75			
$k_{SVR}$ Supply-voltage rejection ratio ( $\Delta V_{DD\pm}/\Delta V_{IO}$ )	$V_{DD\pm} = \pm 2.2\ \text{V to } \pm 8\ \text{V}, V_{IC} = 0, \text{ No load}$	25°C		80	95		80	95	dB	
		Full range		80			80			
$I_{DD}$ Supply current	$V_O = 0, \text{ No load}$	25°C		4.8	6		4.8	6	mA	
		Full range			6			6		

† Full range is 0°C to 70°C.

NOTE 4: Typical values are based on the input offset voltage shift observed through 168 hours of operating life test at  $T_A = 150^\circ\text{C}$  extrapolated to  $T_A = 25^\circ\text{C}$  using the Arrhenius equation and assuming an activation energy of 0.96 eV.

**TLC227x, TLC227xA**  
**Advanced LinCMOS™ RAIL-TO-RAIL**  
**OPERATIONAL AMPLIFIERS**

SLOS190B – FEBRUARY 1997 – REVISED JULY 1999

**TLC2274C operating characteristics at specified free-air temperature,  $V_{DD\pm} = \pm 5\text{ V}$**

PARAMETER	TEST CONDITIONS		$T_A$ †	TLC2274C			TLC2274AC			UNIT	
				MIN	TYP	MAX	MIN	TYP	MAX		
SR	Slew rate at unity gain	$V_O = \pm 2.3\text{ V}$ , $C_L = 100\text{ pF}$	$R_L = 10\text{ k}\Omega$	25°C	2.3	3.6		2.3	3.6	V/ $\mu\text{s}$	
				Full range	1.7			1.7			
$V_n$	Equivalent input noise voltage			25°C	50			50			nV/ $\sqrt{\text{Hz}}$
				$f = 1\text{ Hz}$	9			9			
$V_N(\text{PP})$	Peak-to-peak equivalent input noise voltage			25°C	1			1			$\mu\text{V}$
				$f = 0.1\text{ Hz to }10\text{ Hz}$	1.4			1.4			
$I_n$	Equivalent input noise current			25°C	0.6			0.6			fA/ $\sqrt{\text{Hz}}$
THD + N	Total harmonic distortion plus noise	$V_O = \pm 2.3\text{ V}$ , $f = 20\text{ kHz}$ , $R_L = 10\text{ k}\Omega$		25°C	$A_V = 1$			0.0011%			
					$A_V = 10$			0.004%			
					$A_V = 100$			0.03%			
	Gain-bandwidth product	$f = 10\text{ kHz}$ , $C_L = 100\text{ pF}$	$R_L = 10\text{ k}\Omega$	25°C	2.25			2.25			MHz
BOM	Maximum output-swing bandwidth	$V_{O(\text{PP})} = 4.6\text{ V}$ , $R_L = 10\text{ k}\Omega$	$A_V = 1$ , $C_L = 100\text{ pF}$	25°C	0.54			0.54			MHz
$t_s$	Settling time	$A_V = -1$ , Step = $-2.3\text{ V to }2.3\text{ V}$ , $R_L = 10\text{ k}\Omega$ , $C_L = 100\text{ pF}$	To 0.1%	25°C	1.5			1.5			$\mu\text{s}$
			To 0.01%		3.2			3.2			
$\phi_m$	Phase margin at unity gain	$R_L = 10\text{ k}\Omega$ , $C_L = 100\text{ pF}$		25°C	52°			52°			
	Gain margin			25°C	10			10			dB

† Full range is 0°C to 70°C.



**TLC2272I electrical characteristics at specified free-air temperature,  $V_{DD} = 5\text{ V}$  (unless otherwise noted)**

PARAMETER	TEST CONDITIONS	$T_A$ †	TLC2272I			TLC2272AI			UNIT
			MIN	TYP	MAX	MIN	TYP	MAX	
$V_{IO}$ Input offset voltage	$V_{IC} = 0,$ $V_O = 0,$ $V_{DD\pm} = \pm 2.5\text{ V}$ $R_S = 50\ \Omega$	25°C	300	2500		300	950	$\mu\text{V}$	
		Full range			3000		1500		
$\alpha_{VIO}$ Temperature coefficient of input offset voltage		25°C to 85°C	2			2		$\mu\text{V}/^\circ\text{C}$	
Input offset voltage long-term drift (see Note 4)		25°C	0.002			0.002		$\mu\text{V}/\text{mo}$	
$I_{IO}$ Input offset current		25°C	0.5			0.5		$\text{pA}$	
		Full range			150		150		
$I_{IB}$ Input bias current	25°C	1			1		$\text{pA}$		
	Full range			150		150			
$V_{ICR}$ Common-mode input voltage range	$R_S = 50\ \Omega,$ $ V_{IO}  \leq 5\ \text{mV}$	25°C	0 to 4	-0.3 to 4.2		0 to 4	-0.3 to 4.2	V	
		Full range	0 to 3.5			0 to 3.5			
$V_{OH}$ High-level output voltage	$I_{OH} = -20\ \mu\text{A}$ $I_{OH} = -200\ \mu\text{A}$ $I_{OH} = -1\ \text{mA}$	25°C	4.99		4.99		V		
		25°C	4.85	4.93	4.85	4.93			
		Full range	4.85		4.85				
		25°C	4.25	4.65	4.25	4.65			
$V_{OL}$ Low-level output voltage	$V_{IC} = 2.5\ \text{V},$ $I_{OL} = 50\ \mu\text{A}$ $V_{IC} = 2.5\ \text{V},$ $I_{OL} = 500\ \mu\text{A}$ $V_{IC} = 2.5\ \text{V},$ $I_{OL} = 5\ \text{mA}$	25°C	0.01		0.01		V		
		25°C	0.09	0.15	0.09	0.15			
		Full range	0.15		0.15				
		25°C	0.9	1.5	0.9	1.5			
$A_{VD}$ Large-signal differential voltage amplification	$V_{IC} = 2.5\ \text{V},$ $V_O = 1\ \text{V to } 4\ \text{V}$	$R_L = 10\ \text{k}\Omega^\ddagger$	25°C	15	35	15	35	V/mV	
			Full range	15		15			
		$R_L = 1\ \text{m}\Omega^\ddagger$	25°C	175		175			
$r_{id}$ Differential input resistance		25°C	$10^{12}$		$10^{12}$		$\Omega$		
$r_i$ Common-mode input resistance		25°C	$10^{12}$		$10^{12}$		$\Omega$		
$c_i$ Common-mode input capacitance	$f = 10\ \text{kHz},$ P package	25°C	8		8		$\text{pF}$		
$z_o$ Closed-loop output impedance	$f = 1\ \text{MHz},$ $A_V = 10$	25°C	140		140		$\Omega$		
CMRR Common-mode rejection ratio	$V_{IC} = 0\ \text{to } 2.7\ \text{V},$ $V_O = 2.5\ \text{V},$ $R_S = 50\ \Omega$	25°C	70	75	70	75	dB		
		Full range	70		70				
$k_{SVR}$ Supply-voltage rejection ratio ( $\Delta V_{DD}/\Delta V_{IO}$ )	$V_{DD} = 4.4\ \text{V to } 16\ \text{V},$ $V_{IC} = V_{DD}/2,$ No load	25°C	80	95	80	95	dB		
		Full range	80		80				
$I_{DD}$ Supply current	$V_O = 2.5\ \text{V},$ No load	25°C	2.2	3	2.2	3	mA		
		Full range	3		3				

† Full range is  $-40^\circ\text{C}$  to  $85^\circ\text{C}$ .

‡ Referenced to 2.5 V

NOTE 4: Typical values are based on the input offset voltage shift observed through 168 hours of operating life test at  $T_A = 150^\circ\text{C}$  extrapolated to  $T_A = 25^\circ\text{C}$  using the Arrhenius equation and assuming an activation energy of 0.96 eV.

**TLC227x, TLC227xA**  
**Advanced LinCMOS™ RAIL-TO-RAIL**  
**OPERATIONAL AMPLIFIERS**

SLOS190B – FEBRUARY 1997 – REVISED JULY 1999

**TLC2272I operating characteristics at specified free-air temperature,  $V_{DD} = 5\text{ V}$**

PARAMETER	TEST CONDITIONS	$T_A$ †	TLC2272I			TLC2272AI			UNIT
			MIN	TYP	MAX	MIN	TYP	MAX	
SR	Slew rate at unity gain $V_O = 0.5\text{ V to }2.5\text{ V}$ , $R_L = 10\text{ k}\Omega$ ‡, $C_L = 100\text{ pF}$ ‡	25°C	2.3	3.6		2.3	3.6	V/ $\mu\text{s}$	
		Full range	1.7			1.7			
$V_n$	Equivalent input noise voltage $f = 10\text{ Hz}$ $f = 1\text{ kHz}$	25°C	50			50			nV/ $\sqrt{\text{Hz}}$
		25°C	9			9			
$V_{NPP}$	Peak-to-peak equivalent input noise voltage $f = 0.1\text{ Hz to }1\text{ Hz}$ $f = 0.1\text{ Hz to }10\text{ Hz}$	25°C	1			1			$\mu\text{V}$
		25°C	1.4			1.4			
$I_n$	Equivalent input noise current	25°C	0.6			0.6			fA/ $\sqrt{\text{Hz}}$
THD + N	Total harmonic distortion plus noise $V_O = 0.5\text{ V to }2.5\text{ V}$ , $f = 20\text{ kHz}$ , $R_L = 10\text{ k}\Omega$ ‡	25°C	$A_V = 1$			0.0013%			
			$A_V = 10$			0.004%			
			$A_V = 100$			0.03%			
	Gain-bandwidth product $f = 10\text{ kHz}$ , $C_L = 100\text{ pF}$ ‡	25°C	2.18			2.18			MHz
BOM	Maximum output-swing bandwidth $V_{O(PP)} = 2\text{ V}$ , $R_L = 10\text{ k}\Omega$ ‡, $A_V = 1$ , $C_L = 100\text{ pF}$ ‡	25°C	1			1			MHz
$t_s$	Settling time $A_V = -1$ , Step = 0.5 V to 2.5 V, $R_L = 10\text{ k}\Omega$ ‡, $C_L = 100\text{ pF}$ ‡	25°C	$T_o$ 0.1%			1.5			$\mu\text{s}$
			$T_o$ 0.01%			2.6			
$\phi_m$	Phase margin at unity gain $R_L = 10\text{ k}\Omega$ ‡, $C_L = 100\text{ pF}$ ‡	25°C	50°			50°			
		25°C	10			10			

† Full range is – 40°C to 85°C.

‡ Referenced to 2.5 V



**TLC2272I electrical characteristics at specified free-air temperature,  $V_{DD\pm} = \pm 5\text{ V}$  (unless otherwise noted)**

PARAMETER	TEST CONDITIONS	$T_A$ †	TLC2272I			TLC2272AI			UNIT
			MIN	TYP	MAX	MIN	TYP	MAX	
$V_{IO}$ Input offset voltage		25°C	300	2500		300	950	$\mu\text{V}$	
		Full range			3000		1500		
$\alpha_{VIO}$ Temperature coefficient of input offset voltage		25°C to 85°C	2			2			$\mu\text{V}/^\circ\text{C}$
Input offset voltage long-term drift (see Note 4)	$V_{IC} = 0,$ $R_S = 50\ \Omega$	$V_O = 0,$ 25°C	0.002			0.002			$\mu\text{V}/\text{mo}$
$I_{IO}$ Input offset current		25°C	0.5			0.5			$\text{pA}$
		Full range	150			150			
$I_{IB}$ Input bias current		25°C	1			1			$\text{pA}$
		Full range	150			150			
$V_{ICR}$ Common-mode input voltage range	$R_S = 50\ \Omega,$ $ V_{IO}  \leq 5\ \text{mV}$	25°C	-5 to 4	-5.3 to 4.2		-5 to 4	-5.3 to 4.2	$\text{V}$	
		Full range	-5 to 3.5			-5 to 3.5			
$V_{OM+}$ Maximum positive peak output voltage	$I_O = -20\ \mu\text{A}$ $I_O = -200\ \mu\text{A}$ $I_O = -1\ \text{mA}$	25°C	4.99			4.99			$\text{V}$
		25°C	4.85	4.93		4.85	4.93		
		Full range	4.85			4.85			
		25°C	4.25	4.65		4.25	4.65		
$V_{OM-}$ Maximum negative peak output voltage	$V_{IC} = 0,$ $I_O = 50\ \mu\text{A}$ $V_{IC} = 0,$ $I_O = 500\ \mu\text{A}$ $V_{IC} = 0,$ $I_O = 5\ \text{mA}$	25°C	-4.99			-4.99			$\text{V}$
		25°C	-4.85	-4.91		-4.85	-4.91		
		Full range	-4.85			-4.85			
		25°C	-3.5	-4.1		-3.5	-4.1		
$A_{VD}$ Large-signal differential voltage amplification	$V_O = \pm 4\ \text{V}$	$R_L = 10\ \text{k}\Omega$	25°C	25	50		25	50	$\text{V}/\text{mV}$
			Full range	25			25		
		$R_L = 1\ \text{m}\Omega$	25°C	300			300		
$r_{id}$ Differential input resistance		25°C	$10^{12}$			$10^{12}$			$\Omega$
$r_i$ Common-mode input resistance		25°C	$10^{12}$			$10^{12}$			$\Omega$
$c_i$ Common-mode input capacitance	$f = 10\ \text{kHz},$ P package	25°C	8			8			$\text{pF}$
$z_o$ Closed-loop output impedance	$f = 1\ \text{MHz},$ $A_V = 10$	25°C	130			130			$\Omega$
CMRR Common-mode rejection ratio	$V_{IC} = 0\ \text{to}\ 2.7\ \text{V},$ $V_O = 2.5\ \text{V},$ $R_S = 50\ \Omega$	25°C	75	80		75	80	dB	
		Full range	75			75			
$k_{SVR}$ Supply-voltage rejection ratio ( $\Delta V_{DD\pm}/\Delta V_{IO}$ )	$V_{DD} = 4.4\ \text{V}\ \text{to}\ 16\ \text{V},$ $V_{IC} = V_{DD}/2,$ No load	25°C	80	95		80	95	dB	
		Full range	80			80			
$I_{DD}$ Supply current	$V_O = 2.5\ \text{V},$ No load	25°C	2.4	3		2.4	3	mA	
		Full range	3			3			

† Full range is  $-40^\circ\text{C}$  to  $85^\circ\text{C}$ .

NOTE 4: Typical values are based on the input offset voltage shift observed through 168 hours of operating life test at  $T_A = 150^\circ\text{C}$  extrapolated to  $T_A = 25^\circ\text{C}$  using the Arrhenius equation and assuming an activation energy of 0.96 eV.

**TLC227x, TLC227xA**  
**Advanced LinCMOS™ RAIL-TO-RAIL**  
**OPERATIONAL AMPLIFIERS**

SLOS190B – FEBRUARY 1997 – REVISED JULY 1999

**TLC2272I operating characteristics at specified free-air temperature,  $V_{DD\pm} = \pm 5\text{ V}$**

PARAMETER	TEST CONDITIONS		$T_A$ †	TLC2272I			TLC2272AI			UNIT
				MIN	TYP	MAX	MIN	TYP	MAX	
SR	Slew rate at unity gain	$V_O = \pm 2.3\text{ V}$ , $C_L = 100\text{ pF}$	$R_L = 10\text{ k}\Omega$	25°C	2.3	3.6		2.3	3.6	V/ $\mu$ s
				Full range	1.7			1.7		
$V_n$	Equivalent input noise voltage	$f = 10\text{ Hz}$	$R_L = 10\text{ k}\Omega$	25°C		50		50	nV/ $\sqrt{\text{Hz}}$	
				$f = 1\text{ kHz}$		9		9		
$V_{NPP}$	Peak-to-peak equivalent input noise voltage	$f = 0.1\text{ Hz to }1\text{ Hz}$	$R_L = 10\text{ k}\Omega$	25°C		1		1	$\mu$ V	
				$f = 0.1\text{ Hz to }10\text{ Hz}$		1.4		1.4		
$I_n$	Equivalent input noise current		$R_L = 10\text{ k}\Omega$	25°C		0.6		0.6	fA/ $\sqrt{\text{Hz}}$	
THD + N	Total harmonic distortion plus noise	$V_O = \pm 2.3\text{ V}$ $R_L = 10\text{ k}\Omega$ , $f = 20\text{ kHz}$	$R_L = 10\text{ k}\Omega$	25°C	$A_V = 1$		0.0011%			
					$A_V = 10$		0.004%			
					$A_V = 100$		0.03%			
	Gain-bandwidth product	$f = 10\text{ kHz}$ , $C_L = 100\text{ pF}$	$R_L = 10\text{ k}\Omega$	25°C		2.25		2.25	MHz	
BOM	Maximum output-swing bandwidth	$V_{O(PP)} = 4.6\text{ V}$ , $R_L = 10\text{ k}\Omega$	$A_V = 1$ , $C_L = 100\text{ pF}$	25°C		0.54		0.54	MHz	
$t_s$	Settling time	$A_V = -1$ , Step = $-2.3\text{ V to }2.3\text{ V}$ , $R_L = 10\text{ k}\Omega$ , $C_L = 100\text{ pF}$	$R_L = 10\text{ k}\Omega$	25°C	To 0.1%		1.5		$\mu$ s	
					To 0.01%		3.2			
$\phi_m$	Phase margin at unity gain	$R_L = 10\text{ k}\Omega$	$C_L = 100\text{ pF}$	25°C		52°		52°		
	Gain margin			25°C		10		10	dB	

† Full range is  $-40^\circ\text{C to }85^\circ\text{C}$ .





**TLC2274I electrical characteristics at specified free-air temperature,  $V_{DD} = 5\text{ V}$  (unless otherwise noted)**

PARAMETER	TEST CONDITIONS	$T_A$ †	TLC2274I			TLC2274AI			UNIT
			MIN	TYP	MAX	MIN	TYP	MAX	
$V_{IO}$ Input offset voltage	$V_{DD\pm} = \pm 2.5\text{ V}$ , $V_{IC} = 0$ , $V_O = 0$ , $R_S = 50\ \Omega$	25°C	300	2500		300	950	$\mu\text{V}$	
		Full range			3000		1500		
$\alpha V_{IO}$ Temperature coefficient of input offset voltage		25°C to 85°C		2			2	$\mu\text{V}/^\circ\text{C}$	
Input offset voltage long-term drift (see Note 4)		25°C		0.002			0.002	$\mu\text{V}/\text{mo}$	
$I_{IO}$ Input offset current		25°C		0.5			0.5	$\text{pA}$	
		Full range			150		150		
$I_{IB}$ Input bias current		25°C		1			1	$\text{pA}$	
		Full range			150		150		
$V_{ICR}$ Common-mode input voltage range	$R_S = 50\ \Omega$ , $ V_{IO}  \leq 5\text{ mV}$	25°C	0 to 4	-0.3 to 4.2		0 to 4	-0.3 to 4.2	V	
		Full range	0 to 3.5			0 to 3.5			
$V_{OH}$ High-level output voltage	$I_{OH} = -20\ \mu\text{A}$ $I_{OH} = -200\ \mu\text{A}$ $I_{OH} = -1\text{ mA}$	25°C		4.99			4.99	V	
		25°C	4.85	4.93		4.85	4.93		
		Full range	4.85			4.85			
		25°C	4.25	4.65		4.25	4.65		
$V_{OL}$ Low-level output voltage	$V_{IC} = 2.5\text{ V}$ , $I_{OL} = 50\ \mu\text{A}$ $V_{IC} = 2.5\text{ V}$ , $I_{OL} = 500\ \mu\text{A}$ $V_{IC} = 2.5\text{ V}$ , $I_{OL} = 5\text{ mA}$	25°C		0.01			0.01	V	
		25°C	0.09	0.15		0.09	0.15		
		Full range		0.15			0.15		
		25°C	0.9	1.5		0.9	1.5		
$A_{VD}$ Large-signal differential voltage amplification	$V_{IC} = 2.5\text{ V}$ , $V_O = 1\text{ V to }4\text{ V}$	25°C	$R_L = 10\text{ k}\Omega$ ‡		15	35	15	35	V/mV
			$R_L = 1\text{ M}\Omega$ ‡		15		15		
		Full range	15			15			
$r_{id}$ Differential input resistance		25°C	$10^{12}$			$10^{12}$		$\Omega$	
$r_i$ Common-mode input resistance		25°C	$10^{12}$			$10^{12}$		$\Omega$	
$c_i$ Common-mode input capacitance	$f = 10\text{ kHz}$ , N package	25°C	8			8		pF	
$z_o$ Closed-loop output impedance	$f = 1\text{ MHz}$ , $A_V = 10$	25°C	140			140		$\Omega$	
CMRR Common-mode rejection ratio	$V_{IC} = 0\text{ to }2.7\text{ V}$ , $V_O = 2.5\text{ V}$ , $R_S = 50\ \Omega$	25°C	70	75		70	75	dB	
		Full range	70			70			
$k_{SVR}$ Supply-voltage rejection ratio ( $\Delta V_{DD}/\Delta V_{IO}$ )	$V_{DD} = 4.4\text{ V to }16\text{ V}$ , $V_{IC} = V_{DD}/2$ , No load	25°C	80	95		80	95	dB	
		Full range	80			80			
$I_{DD}$ Supply current	$V_O = 2.5\text{ V}$ , No load	25°C	4.4	6		4.4	6	mA	
		Full range		6			6		

† Full range is  $-40^\circ\text{C}$  to  $85^\circ\text{C}$ .

‡ Referenced to 2.5 V

NOTE 4: Typical values are based on the input offset voltage shift observed through 168 hours of operating life test at  $T_A = 150^\circ\text{C}$  extrapolated to  $T_A = 25^\circ\text{C}$  using the Arrhenius equation and assuming an activation energy of 0.96 eV.

**TLC227x, TLC227xA**  
**Advanced LinCMOS™ RAIL-TO-RAIL**  
**OPERATIONAL AMPLIFIERS**

SLOS190B – FEBRUARY 1997 – REVISED JULY 1999

**TLC2274I operating characteristics at specified free-air temperature,  $V_{DD} = 5\text{ V}$**

PARAMETER	TEST CONDITIONS	$T_A$ †	TLC2274I			TLC2274AI			UNIT	
			MIN	TYP	MAX	MIN	TYP	MAX		
SR	Slew rate at unity gain $V_O = 0.5\text{ V to }2.5\text{ V}$ , $R_L = 10\text{ k}\Omega$ ‡, $C_L = 100\text{ pF}$ ‡	25°C	2.3	3.6		2.3	3.6	V/ $\mu\text{s}$		
		Full range	1.7			1.7				
$V_n$	Equivalent input noise voltage	f = 10 Hz	50			50			nV/ $\sqrt{\text{Hz}}$	
		f = 1 kHz	9			9				
$V_{N(PP)}$	Peak-to-peak equivalent input noise voltage	f = 0.1 Hz to 1 Hz	1			1			$\mu\text{V}$	
		f = 0.1 Hz to 10 Hz	1.4			1.4				
$I_n$	Equivalent input noise current	25°C	0.6			0.6			fA/ $\sqrt{\text{Hz}}$	
THD + N	Total harmonic distortion plus noise $V_O = 0.5\text{ V to }2.5\text{ V}$ , f = 20 kHz, $R_L = 10\text{ k}\Omega$ ‡	$A_V = 1$	0.0013%			0.0013%				
		$A_V = 10$	0.004%			0.004%				
		$A_V = 100$	0.03%			0.03%				
	Gain-bandwidth product	f = 10 kHz, $R_L = 10\text{ k}\Omega$ ‡, $C_L = 100\text{ pF}$ ‡	25°C	2.18			2.18			MHz
BOM	Maximum output-swing bandwidth	$V_{O(PP)} = 2\text{ V}$ , $A_V = 1$ , $R_L = 10\text{ k}\Omega$ ‡, $C_L = 100\text{ pF}$ ‡	25°C	1			1			MHz
$t_s$	Settling time	$A_V = -1$ , Step = 0.5 V to 2.5 V, $R_L = 10\text{ k}\Omega$ ‡, $C_L = 100\text{ pF}$ ‡	To 0.1%	1.5			1.5			$\mu\text{s}$
			To 0.01%	2.6			2.6			
$\phi_m$	Phase margin at unity gain	$R_L = 10\text{ k}\Omega$ ‡, $C_L = 100\text{ pF}$ ‡	25°C	50°			50°			
	Gain margin		25°C	10			10			

† Full range is – 40°C to 85°C.

‡ Referenced to 2.5 V



**TLC2274I electrical characteristics at specified free-air temperature,  $V_{DD\pm} = \pm 5\text{ V}$  (unless otherwise noted)**

PARAMETER	TEST CONDITIONS	$T_A$ †	TLC2274I			TLC2274AI			UNIT
			MIN	TYP	MAX	MIN	TYP	MAX	
$V_{IO}$ Input offset voltage	$V_{IC} = 0, V_O = 0, R_S = 50\ \Omega$	25°C	300	2500		300	950	$\mu\text{V}$	
		Full range			3000		1500		
$\alpha_{VIO}$ Temperature coefficient of input offset voltage		25°C to 85°C	2			2		$\mu\text{V}/^\circ\text{C}$	
Input offset voltage long-term drift (see Note 4)		25°C	0.002			0.002		$\mu\text{V}/\text{mo}$	
$I_{IO}$ Input offset current		25°C	0.5			0.5		$\text{pA}$	
		Full range			150		150		
$I_{IB}$ Input bias current	25°C	1			1		$\text{pA}$		
	Full range			150		150			
$V_{ICR}$ Common-mode input voltage range	$R_S = 50\ \Omega,  V_{IO}  \leq 5\ \text{mV}$	25°C	-5 to 4	-5.3 to 4.2		-5 to 4	-5.3 to 4.2	V	
		Full range	-5 to 3.5			-5 to 3.5			
$V_{OM+}$ Maximum positive peak output voltage	$I_O = -20\ \mu\text{A}$	25°C	4.99			4.99	V		
	$I_O = -200\ \mu\text{A}$	25°C	4.85	4.93		4.85		4.93	
		Full range	4.85			4.85			
	$I_O = -1\ \text{mA}$	25°C	4.25	4.65		4.25		4.65	
Full range		4.25			4.25				
$V_{OM-}$ Maximum negative peak output voltage	$V_{IC} = 0, I_O = 50\ \mu\text{A}$	25°C	-4.99			-4.99	V		
	$V_{IC} = 0, I_O = 500\ \mu\text{A}$	25°C	-4.85	-4.91		-4.85		-4.91	
		Full range	-4.85			-4.85			
	$V_{IC} = 0, I_O = 5\ \text{mA}$	25°C	-3.5	-4.1		-3.5		-4.1	
Full range		-3.5			-3.5				
$A_{VD}$ Large-signal differential voltage amplification	$V_O = \pm 4\ \text{V}$	$R_L = 10\ \text{k}\Omega$	25°C	25	50		25	50	V/mV
			Full range	25			25		
		$R_L = 1\ \text{M}\Omega$	25°C	300			300		
$r_{id}$ Differential input resistance		25°C		$10^{12}$		$10^{12}$		$\Omega$	
$r_i$ Common-mode input resistance		25°C		$10^{12}$		$10^{12}$		$\Omega$	
$c_i$ Common-mode input capacitance	$f = 10\ \text{kHz}, \text{ N package}$	25°C		8		8		pF	
$z_o$ Closed-loop output impedance	$f = 1\ \text{MHz}, A_V = 10$	25°C		130		130		$\Omega$	
CMRR Common-mode rejection ratio	$V_{IC} = -5\ \text{to}\ 2.7\ \text{V}, V_O = 0, R_S = 50\ \Omega$	25°C	75	80		75	80	dB	
		Full range	75			75			
$k_{SVR}$ Supply-voltage rejection ratio ( $\Delta V_{DD\pm}/\Delta V_{IO}$ )	$V_{DD\pm} = \pm 2.2\ \text{V to}\ \pm 8\ \text{V}, V_{IC} = 0, \text{ No load}$	25°C	80	95		80	95	dB	
		Full range	80			80			
$I_{DD}$ Supply current	$V_O = 0, \text{ No load}$	25°C	4.8	6		4.8	6	mA	
		Full range			6		6		

† Full range is  $-40^\circ\text{C}$  to  $85^\circ\text{C}$ .

NOTE 4: Typical values are based on the input offset voltage shift observed through 168 hours of operating life test at  $T_A = 150^\circ\text{C}$  extrapolated to  $T_A = 25^\circ\text{C}$  using the Arrhenius equation and assuming an activation energy of 0.96 eV.

**TLC227x, TLC227xA**  
**Advanced LinCMOS™ RAIL-TO-RAIL**  
**OPERATIONAL AMPLIFIERS**

SLOS190B – FEBRUARY 1997 – REVISED JULY 1999

**TLC2274I operating characteristics at specified free-air temperature,  $V_{DD\pm} = \pm 5\text{ V}$**

PARAMETER	TEST CONDITIONS	$T_A$ †	TLC2274I			TLC2274AI			UNIT
			MIN	TYP	MAX	MIN	TYP	MAX	
SR	Slew rate at unity gain $V_O = \pm 2.3\text{ V}$ , $C_L = 100\text{ pF}$ , $R_L = 10\text{ k}\Omega$	25°C	2.3	3.6		2.3	3.6	V/ $\mu\text{s}$	
		Full range	1.7			1.7			
$V_n$	Equivalent input noise voltage $f = 10\text{ Hz}$ $f = 1\text{ kHz}$	25°C	50			50			nV/ $\sqrt{\text{Hz}}$
		25°C	9			9			
$V_{N(PP)}$	Peak-to-peak equivalent input noise voltage $f = 0.1\text{ Hz to }1\text{ Hz}$ $f = 0.1\text{ Hz to }10\text{ Hz}$	25°C	1			1			$\mu\text{V}$
		25°C	1.4			1.4			
$I_n$	Equivalent input noise current	25°C	0.6			0.6			fA/ $\sqrt{\text{Hz}}$
THD + N	Total harmonic distortion plus noise $V_O = \pm 2.3\text{ V}$ , $R_L = 10\text{ k}\Omega$ , $f = 20\text{ kHz}$	25°C		$A_V = 1$	0.0011%		0.0011%		
				$A_V = 10$	0.004%		0.004%		
				$A_V = 100$	0.03%		0.03%		
	Gain-bandwidth product $f = 10\text{ kHz}$ , $C_L = 100\text{ pF}$ , $R_L = 10\text{ k}\Omega$	25°C	2.25			2.25			MHz
BOM	Maximum output-swing bandwidth $V_{O(PP)} = 4.6\text{ V}$ , $R_L = 10\text{ k}\Omega$ , $A_V = 1$ , $C_L = 100\text{ pF}$	25°C	0.54			0.54			MHz
$t_s$	Settling time $A_V = -1$ , Step = $-2.3\text{ V to }2.3\text{ V}$ , $R_L = 10\text{ k}\Omega$ , $C_L = 100\text{ pF}$	25°C		To 0.1%	1.5		1.5		$\mu\text{s}$
				To 0.01%	3.2		3.2		
$\phi_m$	Phase margin at unity gain $R_L = 10\text{ k}\Omega$ , $C_L = 100\text{ pF}$	25°C	52°			52°			
		25°C	10			10			

† Full range is  $-40^\circ\text{C}$  to  $85^\circ\text{C}$ .



**TLC2272Q and TLC2272M electrical characteristics at specified free-air temperature,  $V_{DD} = 5\text{ V}$  (unless otherwise noted)**

PARAMETER	TEST CONDITIONS	$T_A$ †	TLC2272Q, TLC2272M			TLC2272AQ, TLC2272AM			UNIT	
			MIN	TYP	MAX	MIN	TYP	MAX		
$V_{IO}$ Input offset voltage		25°C	300	2500		300	950	$\mu\text{V}$		
		Full range		3000		1500				
$\alpha_{VIO}$ Temperature coefficient of input offset voltage		25°C to 125°C	2			2			$\mu\text{V}/^\circ\text{C}$	
Input offset voltage long-term drift (see Note 4)	$V_{IC} = 0,$ $V_O = 0,$	$V_{DD\pm} = \pm 2.5\text{ V},$ $R_S = 50\ \Omega$	0.002			0.002			$\mu\text{V}/\text{mo}$	
$I_{IO}$ Input offset current		25°C	0.5			0.5			$\text{pA}$	
		Full range	500			500				
$I_{IB}$ Input bias current		25°C	1			1			$\text{pA}$	
		Full range	500			500				
$V_{ICR}$ Common-mode input voltage range	$R_S = 50\ \Omega,$	$ V_{IO}  \leq 5\text{ mV}$	25°C	0 to 4	-0.3 to 4.2		0 to 4	-0.3 to 4.2	$\text{V}$	
			Full range	0 to 3.5		0 to 3.5				
$V_{OH}$ High-level output voltage	$I_{OH} = -20\ \mu\text{A}$	25°C	4.99			4.99			$\text{V}$	
		25°C	4.85	4.93		4.85	4.93			
		Full range	4.85			4.85				
		25°C	4.25	4.65		4.25	4.65			
$V_{OL}$ Low-level output voltage	$I_{OL} = 50\ \mu\text{A}$	25°C	0.01			0.01			$\text{V}$	
		25°C	0.09	0.15		0.09	0.15			
		Full range	0.15			0.15				
		25°C	0.9	1.5		0.9	1.5			
$A_{VD}$ Large-signal differential voltage amplification	$V_{IC} = 2.5\text{ V},$ $V_O = 1\text{ V to }4\text{ V}$	$R_L = 10\ \text{k}\Omega$ ‡	25°C	10	35		10	35	$\text{V}/\text{mV}$	
			Full range	10			10			
		$R_L = 1\ \text{m}\Omega$ ‡	25°C	175			175			
			Full range	175			175			
$r_{id}$ Differential input resistance		25°C	$10^{12}$			$10^{12}$			$\Omega$	
$r_i$ Common-mode input resistance		25°C	$10^{12}$			$10^{12}$			$\Omega$	
$c_i$ Common-mode input capacitance	$f = 10\ \text{kHz},$	P package	25°C	8			8			$\text{pF}$
$z_o$ Closed-loop output impedance	$f = 1\ \text{MHz},$	$A_V = 10$	25°C	140			140			$\Omega$
CMRR Common-mode rejection ratio	$V_{IC} = 0\text{ to }2.7\text{ V},$ $V_O = 2.5\text{ V},$	$R_S = 50\ \Omega$	25°C	70	75		70	75	$\text{dB}$	
			Full range	70			70			
$k_{SVR}$ Supply-voltage rejection ratio ( $\Delta V_{DD}/\Delta V_{IO}$ )	$V_{DD} = 4.4\text{ V to }16\text{ V},$ $V_{IC} = V_{DD}/2,$	No load	25°C	80	95		80	95	$\text{dB}$	
			Full range	80			80			
$I_{DD}$ Supply current	$V_O = 2.5\text{ V},$	No load	25°C	2.2	3		2.2	3	$\text{mA}$	
			Full range	3			3			

† Full range is  $-40^\circ\text{C}$  to  $125^\circ\text{C}$  for Q level part,  $-55^\circ\text{C}$  to  $125^\circ\text{C}$  for M level part.

‡ Referenced to 2.5 V

NOTE 4: Typical values are based on the input offset voltage shift observed through 168 hours of operating life test at  $T_A = 150^\circ\text{C}$  extrapolated to  $T_A = 25^\circ\text{C}$  using the Arrhenius equation and assuming an activation energy of 0.96 eV.

**TLC227x, TLC227xA**  
**Advanced LinCMOS™ RAIL-TO-RAIL**  
**OPERATIONAL AMPLIFIERS**

SLOS190B – FEBRUARY 1997 – REVISED JULY 1999

**TLC2272Q and TLC2272M operating characteristics at specified free-air temperature,  $V_{DD} = 5\text{ V}$**

PARAMETER	TEST CONDITIONS	$T_A$ †	TLC2272Q, TLC2272M			TLC2272AQ, TLC2272AM			UNIT	
			MIN	TYP	MAX	MIN	TYP	MAX		
SR	Slew rate at unity gain $V_O = 1.25\text{ V to }2.75\text{ V}$ , $R_L = 10\text{ k}\Omega$ ‡, $C_L = 100\text{ pF}$ ‡	25°C	2.3	3.6		2.3	3.6		V/ $\mu\text{s}$	
		Full range	1.7			1.7				
$V_n$	Equivalent input noise voltage	$f = 10\text{ Hz}$	50			50			nV/ $\sqrt{\text{Hz}}$	
		$f = 1\text{ kHz}$	9			9				
$V_{NPP}$	Peak-to-peak equivalent input noise voltage	$f = 0.1\text{ Hz to }1\text{ Hz}$	1			1			$\mu\text{V}$	
		$f = 0.1\text{ Hz to }10\text{ Hz}$	1.4			1.4				
$I_n$	Equivalent input noise current	25°C	0.6			0.6			fA/ $\sqrt{\text{Hz}}$	
THD + N	Total harmonic distortion plus noise $V_O = 0.5\text{ V to }2.5\text{ V}$ , $f = 20\text{ kHz}$ , $R_L = 10\text{ k}\Omega$ ‡	$A_V = 1$	0.0013%			0.0013%				
		$A_V = 10$	0.004%			0.004%				
		$A_V = 100$	0.03%			0.03%				
	Gain-bandwidth product	$f = 10\text{ kHz}$ , $C_L = 100\text{ pF}$ ‡, $R_L = 10\text{ k}\Omega$ ‡	25°C	2.18			2.18			MHz
$B_{OM}$	Maximum output-swing bandwidth	$V_{O(PP)} = 2\text{ V}$ , $R_L = 10\text{ k}\Omega$ ‡, $A_V = 1$ , $C_L = 100\text{ pF}$ ‡	25°C	1			1			MHz
$t_s$	Settling time	$A_V = -1$ , Step = 0.5 V to 2.5 V, $R_L = 10\text{ k}\Omega$ ‡, $C_L = 100\text{ pF}$ ‡	To 0.1%	1.5			1.5			$\mu\text{s}$
			To 0.01%	2.6			2.6			
$\phi_m$	Phase margin at unity gain	$R_L = 10\text{ k}\Omega$ ‡, $C_L = 100\text{ pF}$ ‡	25°C	50°			50°			
	Gain margin		25°C	10			10			

† Full range is  $-40^\circ\text{C}$  to  $125^\circ\text{C}$  for Q level part,  $-55^\circ\text{C}$  to  $125^\circ\text{C}$  for M level part.

‡ Referenced to 2.5 V



**TLC2272Q and TLC2272M electrical characteristics at specified free-air temperature,  $V_{DD\pm} = \pm 5\text{ V}$  (unless otherwise noted)**

PARAMETER	TEST CONDITIONS	$T_A$ †	TLC2272Q, TLC2272M			TLC2272AQ, TLC2272AM			UNIT
			MIN	TYP	MAX	MIN	TYP	MAX	
$V_{IO}$ Input offset voltage		25°C	300	2500		300	950	$\mu\text{V}$	
		Full range		3000		1500			
$\alpha_{VIO}$ Temperature coefficient of input offset voltage		25°C to 125°C	2			2			$\mu\text{V}/^\circ\text{C}$
Input offset voltage long-term drift (see Note 4)	$V_{IC} = 0,$ $R_S = 50\ \Omega$	$V_O = 0,$ 25°C	0.002			0.002			$\mu\text{V}/\text{mo}$
$I_{IO}$ Input offset current		25°C	0.5			0.5			$\text{pA}$
		Full range		500		500			
$I_{IB}$ Input bias current		25°C	1			1			$\text{pA}$
		Full range		500		500			
$V_{ICR}$ Common-mode input voltage range	$R_S = 50\ \Omega,$ $ V_{IO}  \leq 5\text{ mV}$	25°C	-5 to 4	-5.3 to 4.2		-5 to 4	-5.3 to 4.2	$\text{V}$	
		Full range	-5 to 3.5			-5 to 3.5			
$V_{OM+}$ Maximum positive peak output voltage	$I_O = -20\ \mu\text{A}$ $I_O = -200\ \mu\text{A}$ $I_O = -1\ \text{mA}$	25°C	4.99			4.99			$\text{V}$
		25°C	4.85	4.93		4.85	4.93		
		Full range	4.85			4.85			
		25°C	4.25	4.65		4.25	4.65		
$V_{OM-}$ Maximum negative peak output voltage	$V_{IC} = 0,$ $I_O = 50\ \mu\text{A}$ $I_O = 500\ \mu\text{A}$ $I_O = 5\ \text{mA}$	25°C	-4.99			-4.99			$\text{V}$
		25°C	-4.85	-4.91		-4.85	-4.91		
		Full range	-4.85			-4.85			
		25°C	-3.5	-4.1		-3.5	-4.1		
$A_{VD}$ Large-signal differential voltage amplification	$V_O = \pm 4\ \text{V}$	$R_L = 10\ \text{k}\Omega$	25°C	20	50		20	50	$\text{V}/\text{mV}$
			Full range	20			20		
		$R_L = 1\ \text{m}\Omega$	25°C	300			300		
$r_{id}$ Differential input resistance		25°C	$10^{12}$			$10^{12}$			$\Omega$
$r_i$ Common-mode input resistance		25°C	$10^{12}$			$10^{12}$			$\Omega$
$c_i$ Common-mode input capacitance	$f = 10\ \text{kHz},$ P package	25°C	8			8			$\text{pF}$
$z_o$ Closed-loop output impedance	$f = 1\ \text{MHz},$ $A_V = 10$	25°C	130			130			$\Omega$
CMRR Common-mode rejection ratio	$V_{IC} = -5\ \text{to}\ 2.7\ \text{V},$ $V_O = 0\ \text{V},$ $R_S = 50\ \Omega$	25°C	75	80		75	80	$\text{dB}$	
		Full range	75			75			
$k_{SVR}$ Supply-voltage rejection ratio ( $\Delta V_{DD\pm}/\Delta V_{IO}$ )	$V_{DD} = \pm 2.2\ \text{V to } \pm 8\ \text{V},$ $V_{IC} = 0,$ No load	25°C	80	95		80	95	$\text{dB}$	
		Full range	80			80			
$I_{DD}$ Supply current	$V_O = 2.5\ \text{V},$ No load	25°C	2.4	3		2.4	3	$\text{mA}$	
		Full range	3			3			

† Full range is  $-40^\circ\text{C}$  to  $125^\circ\text{C}$  for Q level part,  $-55^\circ\text{C}$  to  $125^\circ\text{C}$  for M level part.

NOTE 4: Typical values are based on the input offset voltage shift observed through 168 hours of operating life test at  $T_A = 150^\circ\text{C}$  extrapolated to  $T_A = 25^\circ\text{C}$  using the Arrhenius equation and assuming an activation energy of 0.96 eV.

**TLC227x, TLC227xA**  
**Advanced LinCMOS™ RAIL-TO-RAIL**  
**OPERATIONAL AMPLIFIERS**

SLOS190B – FEBRUARY 1997 – REVISED JULY 1999

**TLC2272Q and TLC2272M operating characteristics at specified free-air temperature,**  
 **$V_{DD\pm} = \pm 5\text{ V}$**

PARAMETER	TEST CONDITIONS	$T_A$ †	TLC2272Q, TLC2272M			TLC2272AQ, TLC2272AM			UNIT
			MIN	TYP	MAX	MIN	TYP	MAX	
SR	Slew rate at unity gain $V_O = \pm 1\text{ V},$ $C_L = 100\text{ pF}$ $R_L = 10\text{ k}\Omega,$	25°C	2.3	3.6		2.3	3.6		V/ $\mu\text{s}$
		Full range	1.7			1.7			
$V_n$	Equivalent input noise voltage $f = 10\text{ Hz}$ $f = 1\text{ kHz}$	25°C		50			50		nV/ $\sqrt{\text{Hz}}$
		25°C		9			9		
$V_{NPP}$	Peak-to-peak equivalent input noise voltage $f = 0.1\text{ Hz to }1\text{ Hz}$ $f = 0.1\text{ Hz to }10\text{ Hz}$	25°C		1			1		$\mu\text{V}$
		25°C		1.4			1.4		
$I_n$	Equivalent input noise current	25°C		0.6			0.6		fA/ $\sqrt{\text{Hz}}$
THD + N	Total harmonic distortion plus noise $V_O = \pm 2.3\text{ V}$ $R_L = 10\text{ k}\Omega,$ $f = 20\text{ kHz}$	25°C		$A_V = 1$		0.0011%		0.0011%	
				$A_V = 10$		0.004%		0.004%	
				$A_V = 100$		0.03%		0.03%	
	Gain-bandwidth product $f = 10\text{ kHz},$ $C_L = 100\text{ pF}$ $R_L = 10\text{ k}\Omega,$	25°C		2.25			2.25		MHz
BOM	Maximum output-swing bandwidth $V_{O(PP)} = 4.6\text{ V},$ $R_L = 10\text{ k}\Omega,$ $A_V = 1,$ $C_L = 100\text{ pF}$	25°C		0.54			0.54		MHz
$t_s$	Settling time $A_V = -1,$ Step = $-2.3\text{ V to }2.3\text{ V},$ $R_L = 10\text{ k}\Omega,$ $C_L = 100\text{ pF}$	25°C		To 0.1%		1.5		1.5	$\mu\text{s}$
				To 0.01%		3.2		3.2	
$\phi_m$	Phase margin at unity gain $R_L = 10\text{ k}\Omega,$ $C_L = 100\text{ pF}$	25°C		52°			52°		
		25°C		10			10		dB

† Full range is  $-40^\circ\text{C to }125^\circ\text{C}$  for Q level part,  $-55^\circ\text{C to }125^\circ\text{C}$  for M level part.





**TLC2274Q and TLC2274M electrical characteristics at specified free-air temperature,  $V_{DD} = 5\text{ V}$  (unless otherwise noted)**

PARAMETER	TEST CONDITIONS	$T_A$ †	TLC2274Q, TLC2274M			TLC2274AQ, TLC2274AM			UNIT
			MIN	TYP	MAX	MIN	TYP	MAX	
$V_{IO}$ Input offset voltage		25°C	300	2500		300	950	$\mu\text{V}$	
		Full range		3000		1500			
$\alpha_{VIO}$ Temperature coefficient of input offset voltage	$V_{DD\pm} = \pm 2.5\text{ V}$ , $V_O = 0$ , $V_{IC} = 0$ , $R_S = 50\ \Omega$	25°C to 125°C	2			2			$\mu\text{V}/^\circ\text{C}$
Input offset voltage long-term drift (see Note 4)		25°C	0.002			0.002			$\mu\text{V}/\text{mo}$
$I_{IO}$ Input offset current		25°C	0.5			0.5			$\text{pA}$
		Full range	500			500			
$I_{IB}$ Input bias current	25°C	1			1			$\text{pA}$	
	Full range	500			500				
$V_{ICR}$ Common-mode input voltage range	$R_S = 50\ \Omega$ , $ V_{IO}  \leq 5\text{ mV}$	25°C	0 to 4	-0.3 to 4.2		0 to 4	-0.3 to 4.2	V	
		Full range	0 to 3.5			0 to 3.5			
$V_{OH}$ High-level output voltage	$I_{OH} = -20\ \mu\text{A}$	25°C	4.99		4.99		V		
	$I_{OH} = -200\ \mu\text{A}$	25°C	4.85	4.93	4.85	4.93			
	$I_{OH} = -1\text{ mA}$	25°C	4.25	4.65	4.25	4.65			
		Full range	4.25		4.25				
$V_{OL}$ Low-level output voltage	$V_{IC} = 2.5\text{ V}$ , $I_{OL} = 50\ \mu\text{A}$	25°C	0.01		0.01		V		
	$V_{IC} = 2.5\text{ V}$ , $I_{OL} = 500\ \mu\text{A}$	25°C	0.09	0.15	0.09	0.15			
		Full range	0.15		0.15				
	$V_{IC} = 2.5\text{ V}$ , $I_{OL} = 5\text{ mA}$	25°C	0.9	1.5	0.9	1.5			
Full range		1.5		1.5					
$A_{VD}$ Large-signal differential voltage amplification	$V_{IC} = 2.5\text{ V}$ , $V_O = 1\text{ V to }4\text{ V}$	$R_L = 10\text{ k}\Omega$ ‡	25°C	10	35	10	35	V/mV	
			Full range	10		10			
		$R_L = 1\text{ M}\Omega$ ‡	25°C	175		175			
$r_{id}$ Differential input resistance		25°C	$10^{12}$			$10^{12}$		$\Omega$	
$r_i$ Common-mode input resistance		25°C	$10^{12}$			$10^{12}$		$\Omega$	
$c_i$ Common-mode input capacitance	$f = 10\text{ kHz}$ , N package	25°C	8			8		pF	
$z_o$ Closed-loop output impedance	$f = 1\text{ MHz}$ , $A_V = 10$	25°C	140			140		$\Omega$	
CMRR Common-mode rejection ratio	$V_{IC} = 0\text{ to }2.7\text{ V}$ , $V_O = 2.5\text{ V}$ , $R_S = 50\ \Omega$	25°C	70	75	70	75	dB		
		Full range	70		70				
$k_{SVR}$ Supply-voltage rejection ratio ( $\Delta V_{DD}/\Delta V_{IO}$ )	$V_{DD} = 4.4\text{ V to }16$ , $V_{IC} = V_{DD}/2$ , No load	25°C	80	95	80	95	dB		
		Full range	80		80				

† Full range is  $-40^\circ\text{C}$  to  $125^\circ\text{C}$  for Q level part,  $-55^\circ\text{C}$  to  $125^\circ\text{C}$  for M level part.

‡ Referenced to 2.5 V

NOTE 4: Typical values are based on the input offset voltage shift observed through 168 hours of operating life test at  $T_A = 150^\circ\text{C}$  extrapolated to  $T_A = 25^\circ\text{C}$  using the Arrhenius equation and assuming an activation energy of 0.96 eV.

**TLC227x, TLC227xA**  
**Advanced LinCMOS™ RAIL-TO-RAIL**  
**OPERATIONAL AMPLIFIERS**

SLOS190B – FEBRUARY 1997 – REVISED JULY 1999

**TLC2274Q and TLC2274M electrical characteristics at specified free-air temperature,  $V_{DD} = 5\text{ V}$  (unless otherwise noted) (continued)**

PARAMETER	TEST CONDITIONS	$T_A$ †	TLC2274Q, TLC2274M			TLC2274AQ, TLC2274AM			UNIT
			MIN	TYP	MAX	MIN	TYP	MAX	
$I_{DD}$ Supply current	$V_O = 2.5\text{ V}$ , No load	25°C	4.4	6		4.4	6	mA	
		Full range			6		6		

† Full range is  $-40^\circ\text{C}$  to  $125^\circ\text{C}$  for Q level part,  $-55^\circ\text{C}$  to  $125^\circ\text{C}$  for M level part.

**TLC2274Q and TLC2274M operating characteristics at specified free-air temperature,  $V_{DD} = 5\text{ V}$**

PARAMETER	TEST CONDITIONS	$T_A$ †	TLC2274Q, TLC2274M			TLC2274AQ, TLC2274AM			UNIT
			MIN	TYP	MAX	MIN	TYP	MAX	
SR Slew rate at unity gain	$V_O = 0.5\text{ V}$ to $2.5\text{ V}$ , $R_L = 10\text{ k}\Omega$ ‡, $C_L = 100\text{ pF}$ ‡	25°C	2.3	3.6		2.3	3.6	$\text{V}/\mu\text{s}$	
		Full range	1.7			1.7			
$V_n$ Equivalent input noise voltage	$f = 10\text{ Hz}$	25°C	50			50			$\text{nV}/\sqrt{\text{Hz}}$
	$f = 1\text{ kHz}$	25°C	9			9			
$V_{N(PP)}$ Peak-to-peak equivalent input noise voltage	$f = 0.1\text{ Hz}$ to $1\text{ Hz}$	25°C	1			1			$\mu\text{V}$
	$f = 0.1\text{ Hz}$ to $10\text{ Hz}$	25°C	1.4			1.4			
$I_n$ Equivalent input noise current		25°C	0.6			0.6			$\text{fA}/\sqrt{\text{Hz}}$
THD + N Total harmonic distortion plus noise	$V_O = 0.5\text{ V}$ to $2.5\text{ V}$ , $f = 20\text{ kHz}$ , $R_L = 10\text{ k}\Omega$ ‡	$A_V = 1$	0.0013%			0.0013%			
		$A_V = 10$	0.004%			0.004%			
		$A_V = 100$	0.03%			0.03%			
Gain-bandwidth product	$f = 10\text{ kHz}$ , $C_L = 100\text{ pF}$ ‡, $R_L = 10\text{ k}\Omega$ ‡	25°C	2.18			2.18			MHz
BOM Maximum output-swing bandwidth	$V_{O(PP)} = 2\text{ V}$ , $R_L = 10\text{ k}\Omega$ ‡, $A_V = 1$ , $C_L = 100\text{ pF}$ ‡	25°C	1			1			MHz
$t_s$ Settling time	$A_V = -1$ , Step = $0.5\text{ V}$ to $2.5\text{ V}$ , $R_L = 10\text{ k}\Omega$ ‡, $C_L = 100\text{ pF}$ ‡	To 0.1%	1.5			1.5			$\mu\text{s}$
		To 0.01%	2.6			2.6			
$\phi_m$ Phase margin at unity gain	$R_L = 10\text{ k}\Omega$ ‡, $C_L = 100\text{ pF}$ ‡	25°C	50°			50°			
Gain margin		25°C	10			10			

† Full range is  $-40^\circ\text{C}$  to  $125^\circ\text{C}$  for Q level part,  $-55^\circ\text{C}$  to  $125^\circ\text{C}$  for M level part.

‡ Referenced to  $2.5\text{ V}$



**TLC2274Q and TLC2274M electrical characteristics at specified free-air temperature,  $V_{DD\pm} = \pm 5\text{ V}$  (unless otherwise noted)**

PARAMETER	TEST CONDITIONS	$T_A$ †	TLC2274Q, TLC2274M			TLC2274AQ, TLC2274AM			UNIT
			MIN	TYP	MAX	MIN	TYP	MAX	
$V_{IO}$ Input offset voltage	$V_{IC} = 0, V_O = 0,$ $R_S = 50\ \Omega$	25°C	300	2500		300	950	$\mu\text{V}$	
		Full range			3000		1500		
$\alpha_{VIO}$ Temperature coefficient of input offset voltage		25°C to 125°C		2			2	$\mu\text{V}/^\circ\text{C}$	
Input offset voltage long-term drift (see Note 4)		25°C		0.002			0.002	$\mu\text{V}/\text{mo}$	
$I_{IO}$ Input offset current		25°C		0.5			0.5	$\text{pA}$	
		Full range			500		500		
$I_{IB}$ Input bias current	25°C		1			1	$\text{pA}$		
	Full range			500		500			
$V_{ICR}$ Common-mode input voltage range	$R_S = 50\ \Omega,  V_{IO}  \leq 5\ \text{mV}$	25°C	-5 to 4	-5.3 to 4.2		-5 to 4	-5.3 to 4.2	$\text{V}$	
		Full range	-5 to 3.5			-5 to 3.5			
$V_{OM+}$ Maximum positive peak output voltage	$I_O = -20\ \mu\text{A}$	25°C		4.99			4.99	$\text{V}$	
	$I_O = -200\ \mu\text{A}$	25°C	4.85	4.93		4.85	4.93		
		Full range	4.85			4.85			
	$I_O = -1\ \text{mA}$	25°C	4.25	4.65		4.25	4.65		
Full range		4.25			4.25				
$V_{OM-}$ Maximum negative peak output voltage	$V_{IC} = 0, I_O = 50\ \mu\text{A}$	25°C		-4.99			-4.99	$\text{V}$	
	$V_{IC} = 0, I_O = 500\ \mu\text{A}$	25°C	-4.85	-4.91		-4.85	-4.91		
		Full range	-4.85			-4.85			
	$V_{IC} = 0, I_O = 5\ \text{mA}$	25°C	-3.5	-4.1		-3.5	-4.1		
Full range		-3.5			-3.5				
$A_{VD}$ Large-signal differential voltage amplification	$V_O = \pm 4\ \text{V}$	$R_L = 10\ \text{k}\Omega$	25°C	20	50		20	50	$\text{V}/\text{mV}$
			Full range	20			20		
		$R_L = 1\ \text{M}\Omega$	25°C		300			300	
$r_{id}$ Differential input resistance		25°C		$10^{12}$			$10^{12}$	$\Omega$	
$r_i$ Common-mode input resistance		25°C		$10^{12}$			$10^{12}$	$\Omega$	
$c_i$ Common-mode input capacitance	$f = 10\ \text{kHz}, \text{ N package}$	25°C		8			8	$\text{pF}$	
$z_o$ Closed-loop output impedance	$f = 1\ \text{MHz}, A_V = 10$	25°C		130			130	$\Omega$	
CMRR Common-mode rejection ratio	$V_{IC} = -5\ \text{V to } 2.7\ \text{V}$ $V_O = 0, R_S = 50\ \Omega$	25°C	75	80		75	80	$\text{dB}$	
		Full range	75			75			
$k_{SVR}$ Supply-voltage rejection ratio ( $\Delta V_{DD\pm}/\Delta V_{IO}$ )	$V_{DD\pm} = \pm 2.2\ \text{V to } \pm 8\ \text{V},$ $V_{IC} = 0, \text{ No load}$	25°C	80	95		80	95	$\text{dB}$	
		Full range	80			80			

† Full range is -40°C to 125°C for Q level part, -55°C to 125°C for M level part.

NOTE 4: Typical values are based on the input offset voltage shift observed through 168 hours of operating life test at  $T_A = 150^\circ\text{C}$  extrapolated to  $T_A = 25^\circ\text{C}$  using the Arrhenius equation and assuming an activation energy of 0.96 eV.

**TLC227x, TLC227xA**  
**Advanced LinCMOS™ RAIL-TO-RAIL**  
**OPERATIONAL AMPLIFIERS**

SLOS190B – FEBRUARY 1997 – REVISED JULY 1999

**TLC2274Q and TLC2274M electrical characteristics at specified free-air temperature,  $V_{DD\pm} = \pm 5\text{ V}$  (unless otherwise noted) (continued)**

PARAMETER	TEST CONDITIONS	$T_A$ †	TLC2274Q, TLC2274M			TLC2274AQ, TLC2274AM			UNIT
			MIN	TYP	MAX	MIN	TYP	MAX	
$I_{DD}$ Supply current	$V_O = 0$ , No load	25°C	4.8	6		4.8	6	mA	
		Full range		6			6		

† Full range is  $-40^\circ\text{C}$  to  $125^\circ\text{C}$  for Q level part,  $-55^\circ\text{C}$  to  $125^\circ\text{C}$  for M level part.

**TLC2274Q and TLC2274M operating characteristics at specified free-air temperature,  $V_{DD\pm} = \pm 5\text{ V}$**

PARAMETER	TEST CONDITIONS	$T_A$ †	TLC2274Q, TLC2274M			TLC2274AQ, TLC2274AM			UNIT
			MIN	TYP	MAX	MIN	TYP	MAX	
SR Slew rate at unity gain	$V_O = \pm 2.3\text{ V}$ , $C_L = 100\text{ pF}$ , $R_L = 10\text{ k}\Omega$	25°C	2.3	3.6		2.3	3.6	$\text{V}/\mu\text{s}$	
		Full range	1.7			1.7			
$V_n$ Equivalent input noise voltage	$f = 10\text{ Hz}$ $f = 1\text{ kHz}$	25°C	50			50			$\text{nV}/\sqrt{\text{Hz}}$
		25°C	9			9			
$V_{N(PP)}$ Peak-to-peak equivalent input noise voltage	$f = 0.1\text{ Hz to }1\text{ Hz}$ $f = 0.1\text{ Hz to }10\text{ Hz}$	25°C	1			1			$\mu\text{V}$
		25°C	1.4			1.4			
$I_n$ Equivalent input noise current		25°C	0.6			0.6			$\text{fA}/\sqrt{\text{Hz}}$
THD + N Total harmonic distortion plus noise	$V_O = \pm 2.3\text{ V}$ , $R_L = 10\text{ k}\Omega$ , $f = 20\text{ kHz}$	25°C	$A_V = 1$			0.0011%			
			$A_V = 10$			0.004%			
			$A_V = 100$			0.03%			
Gain-bandwidth product	$f = 10\text{ kHz}$ , $C_L = 100\text{ pF}$ , $R_L = 10\text{ k}\Omega$	25°C	2.25			2.25			MHz
BOM Maximum output-swing bandwidth	$V_{O(PP)} = 4.6\text{ V}$ , $R_L = 10\text{ k}\Omega$ , $C_L = 100\text{ pF}$ , $A_V = 1$	25°C	0.54			0.54			MHz
$t_s$ Settling time	$A_V = -1$ , Step = $-2.3\text{ V to }2.3\text{ V}$ , $R_L = 10\text{ k}\Omega$ , $C_L = 100\text{ pF}$	25°C	To 0.1%			1.5			$\mu\text{s}$
			To 0.01%			3.2			
$\phi_m$ Phase margin at unit gain	$R_L = 10\text{ k}\Omega$ , $C_L = 100\text{ pF}$	25°C	52°			52°			
Gain margin		25°C	10			10			dB

† Full range is  $-40^\circ\text{C}$  to  $125^\circ\text{C}$  for Q level part,  $-55^\circ\text{C}$  to  $125^\circ\text{C}$  for M level part.



## TYPICAL CHARACTERISTICS

Table of Graphs

			FIGURE
$V_{IO}$	Input offset voltage	Distribution vs Common-mode voltage	1 – 4 5, 6
$\alpha_{VIO}$	Input offset voltage temperature coefficient	Distribution	7 – 10
$I_{IB}/I_{IO}$	Input bias and input offset current	vs Free-air temperature	11
$V_I$	Input voltage range	vs Supply voltage vs Free-air temperature	12 13
$V_{OH}$	High-level output voltage	vs High-level output current	14
$V_{OL}$	Low-level output voltage	vs Low-level output current	15, 16
$V_{OM+}$	Maximum positive peak output voltage	vs Output current	17
$V_{OM-}$	Maximum negative peak output voltage	vs Output current	18
$V_{O(PP)}$	Maximum peak-to-peak output voltage	vs Frequency	19
$I_{OS}$	Short-circuit output current	vs Supply voltage vs Free-air temperature	20 21
$V_O$	Output voltage	vs Differential input voltage	22, 23
$A_{VD}$	Large-signal differential voltage amplification	vs Load resistance vs Frequency vs Free-air temperature	24 25, 26 27, 28
$z_o$	Output impedance	vs Frequency	29, 30
CMRR	Common-mode rejection ratio	vs Frequency vs Free-air temperature	31 32
$k_{SVR}$	Supply-voltage rejection ratio	vs Frequency vs Free-air temperature	33, 34 35
$I_{DD}$	Supply current	vs Supply voltage vs Free-air temperature	36, 37 38, 39
SR	Slew rate	vs Load capacitance vs Free-air temperature	40 41
$V_O$	Inverting large-signal pulse response		42, 43
	Voltage-follower large-signal pulse response		44, 45
	Inverting small-signal pulse response		46, 47
	Voltage-follower small-signal pulse response		48, 49
$V_n$	Equivalent input noise voltage	vs Frequency	50, 51
	Noise voltage (referred to input)	Over a 10-second period	52
	Integrated noise voltage	vs Frequency	53
THD + N	Total harmonic distortion plus noise	vs Frequency	54
	Gain-bandwidth product	vs Supply voltage vs Free-air temperature	55 56
$\phi_m$	Phase margin	vs Load capacitance vs Frequency	57 25, 26
	Gain margin	vs Load capacitance	58

NOTE: For all graphs where  $V_{DD} = 5\text{ V}$ , all loads are referenced to 2.5 V.

TYPICAL CHARACTERISTICS

DISTRIBUTION OF TLC2272  
 INPUT OFFSET VOLTAGE

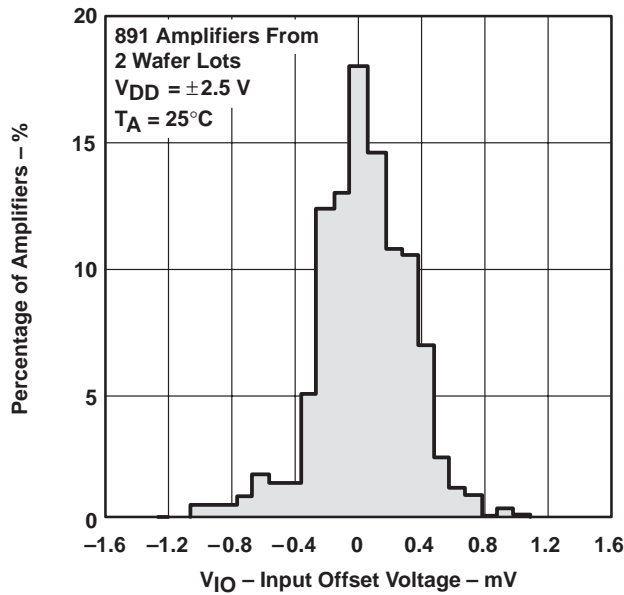

Figure 1

DISTRIBUTION OF TLC2272  
 INPUT OFFSET VOLTAGE

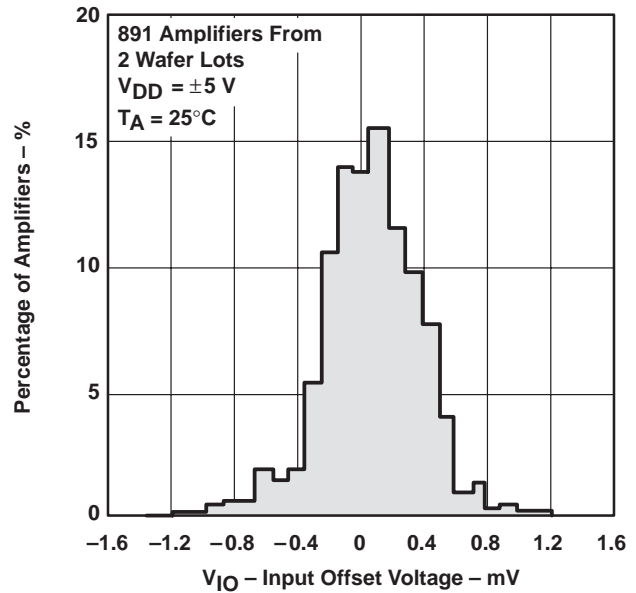

Figure 2

DISTRIBUTION OF TLC2274  
 INPUT OFFSET VOLTAGE

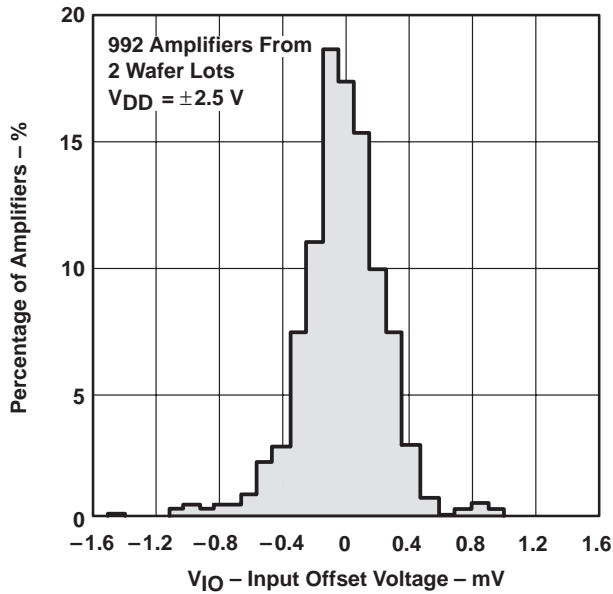

Figure 3

DISTRIBUTION OF TLC2274  
 INPUT OFFSET VOLTAGE

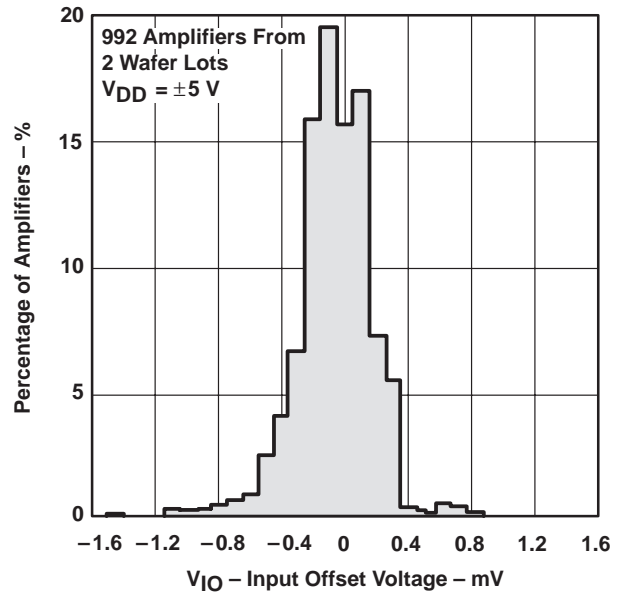

Figure 4

TYPICAL CHARACTERISTICS

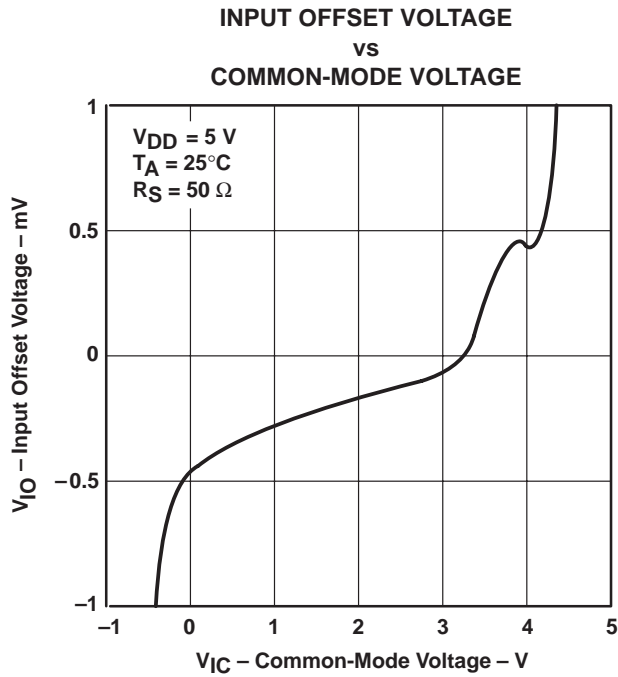

Figure 5

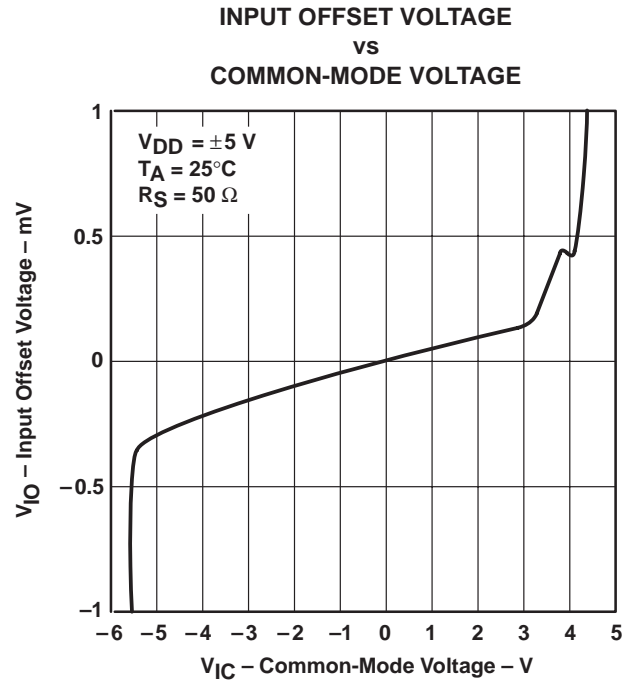

Figure 6

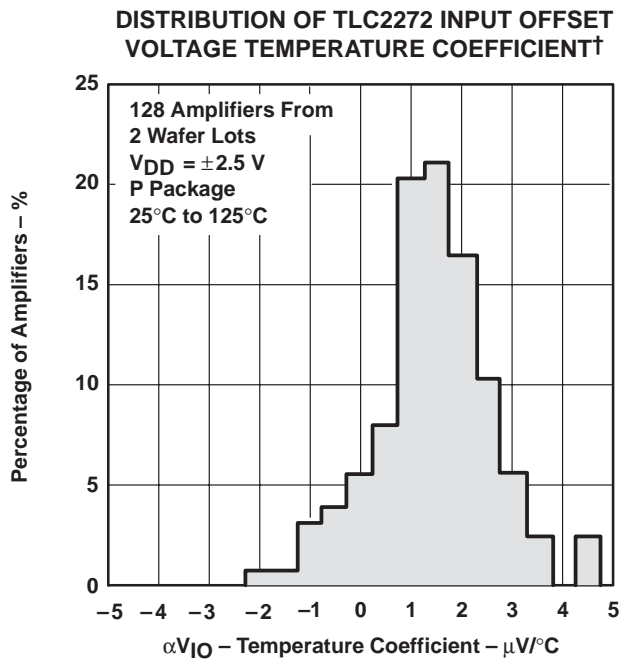

Figure 7

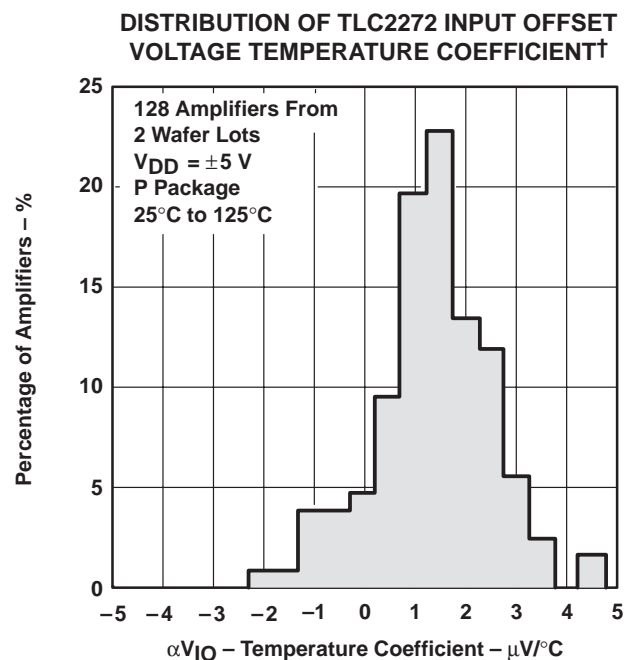

Figure 8

† Data at high and low temperatures are applicable only within the rated operating free-air temperature ranges of the various devices.

TYPICAL CHARACTERISTICS

DISTRIBUTION OF TLC2274 INPUT OFFSET VOLTAGE TEMPERATURE COEFFICIENT†

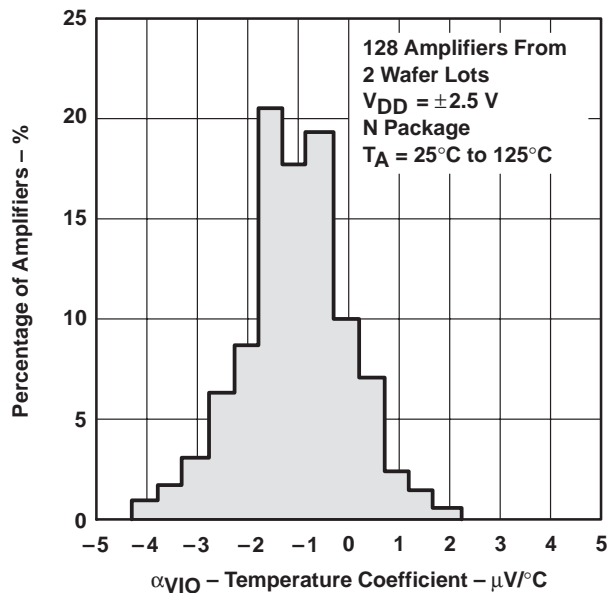

Figure 9

DISTRIBUTION OF TLC2274 INPUT OFFSET VOLTAGE TEMPERATURE COEFFICIENT†

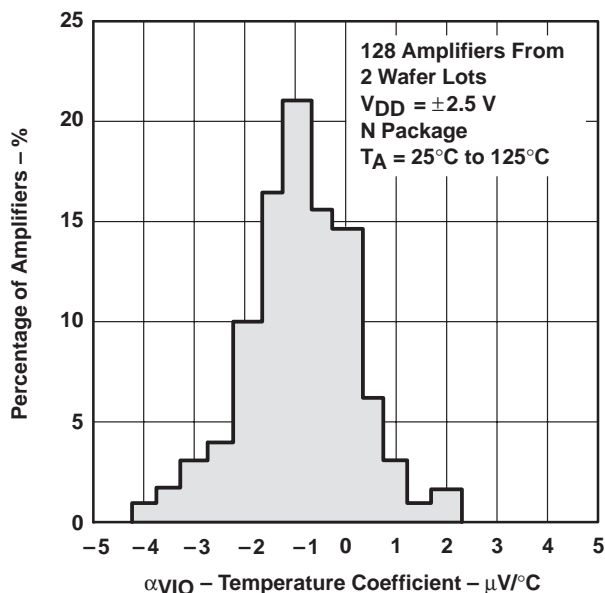

Figure 10

INPUT BIAS AND INPUT OFFSET CURRENT†  
 vs  
 FREE-AIR TEMPERATURE

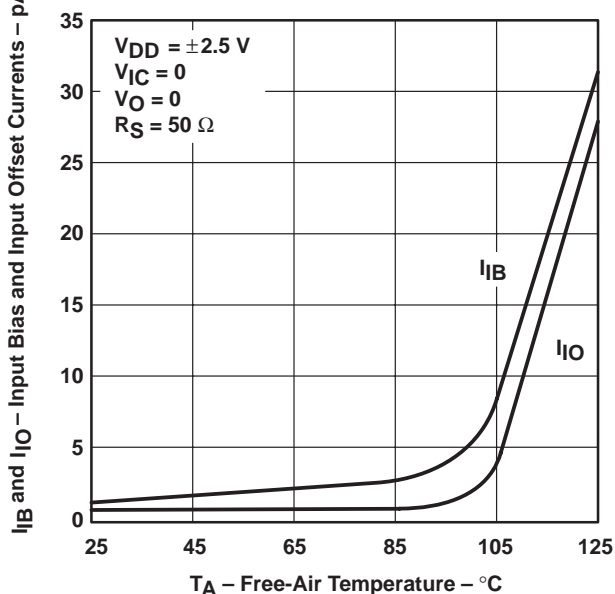

Figure 11

INPUT VOLTAGE RANGE  
 vs  
 SUPPLY VOLTAGE

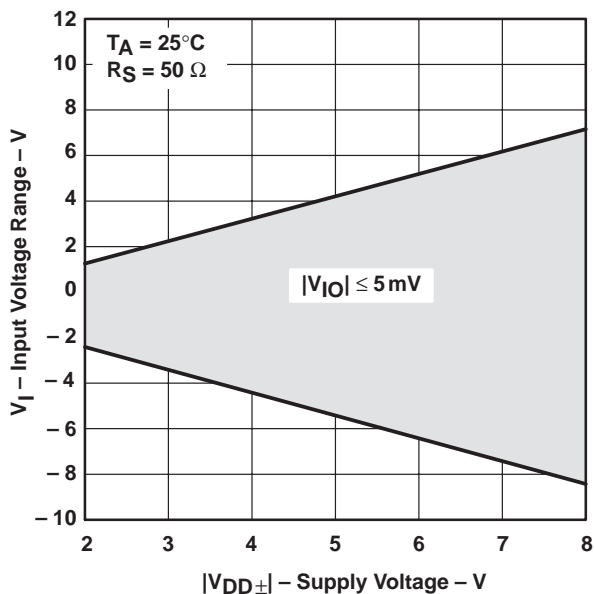

Figure 12

† Data at high and low temperatures are applicable only within the rated operating free-air temperature ranges of the various devices.



TYPICAL CHARACTERISTICS

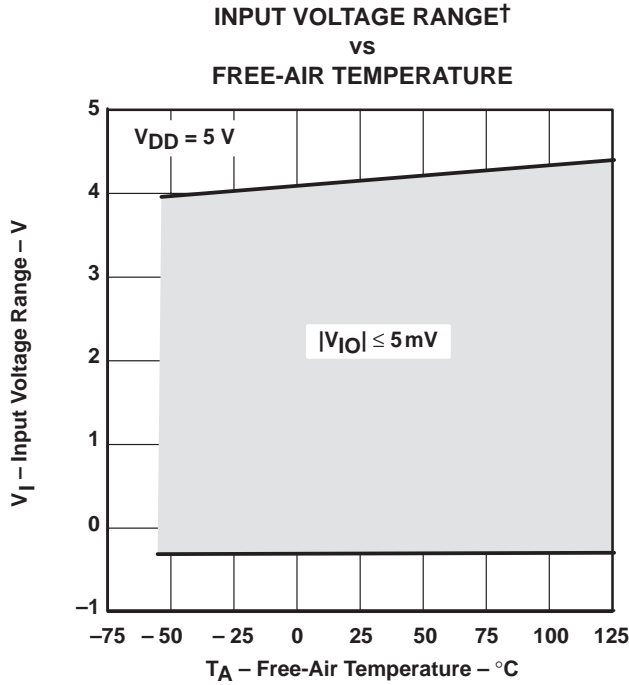

Figure 13

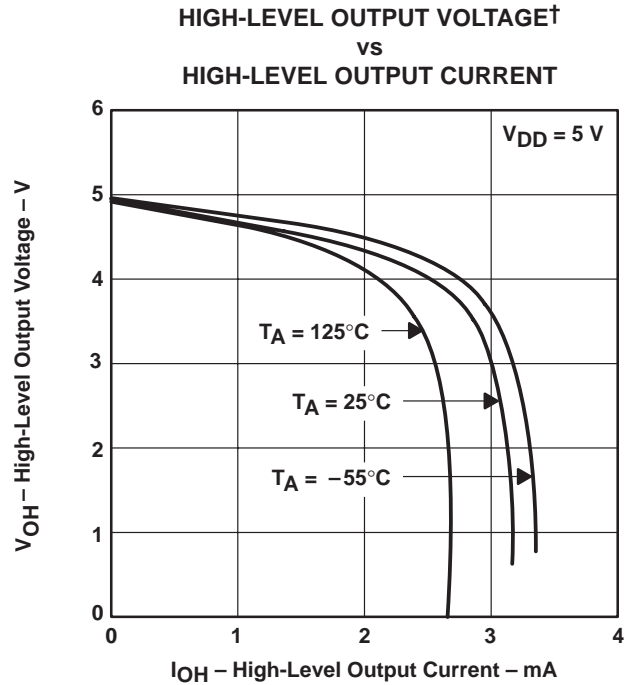

Figure 14

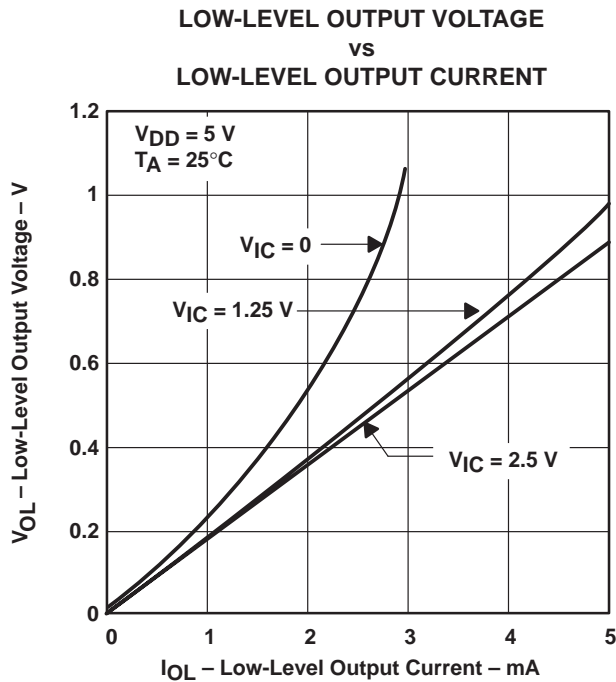

Figure 15

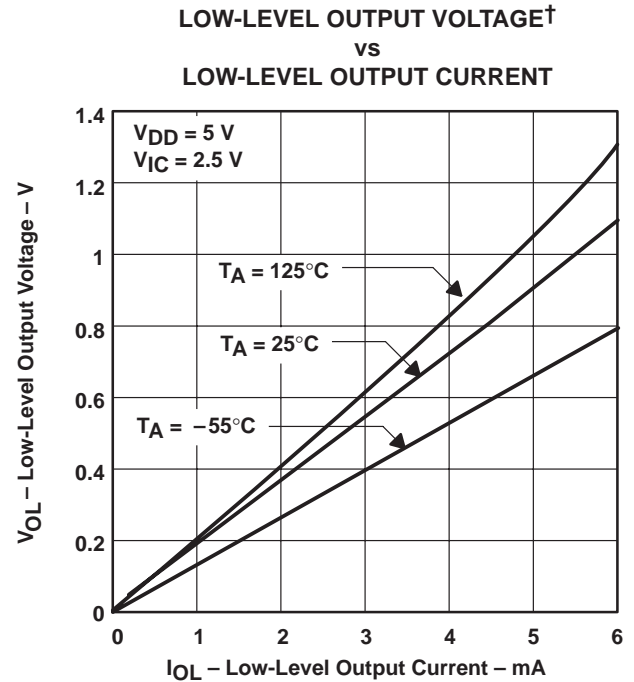

Figure 16

† Data at high and low temperatures are applicable only within the rated operating free-air temperature ranges of the various devices.

TYPICAL CHARACTERISTICS

MAXIMUM POSITIVE PEAK OUTPUT VOLTAGE†  
 vs  
 OUTPUT CURRENT

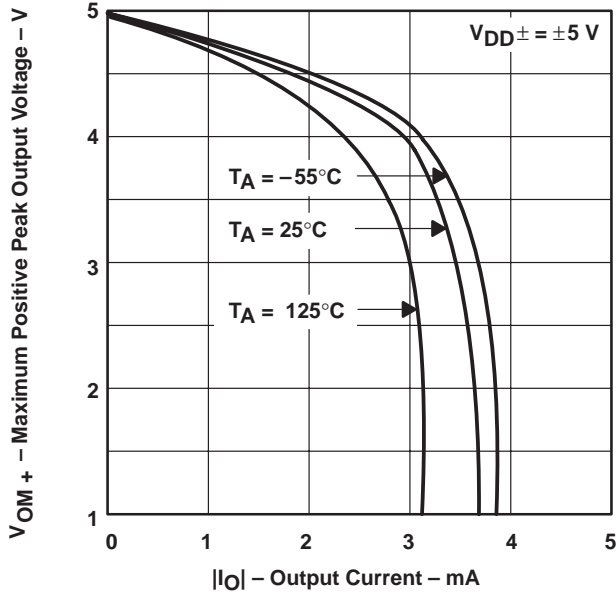

Figure 17

MAXIMUM NEGATIVE PEAK OUTPUT VOLTAGE†  
 vs  
 OUTPUT CURRENT

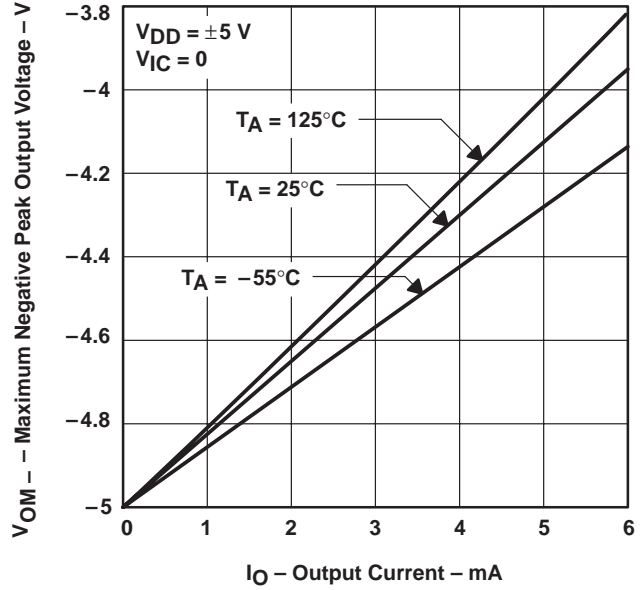

Figure 18

MAXIMUM PEAK-TO-PEAK OUTPUT VOLTAGE  
 vs  
 FREQUENCY

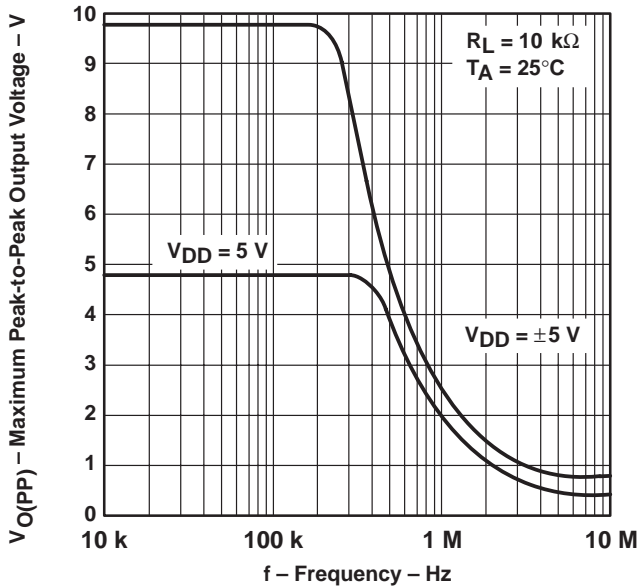

Figure 19

SHORT-CIRCUIT OUTPUT CURRENT  
 vs  
 SUPPLY VOLTAGE

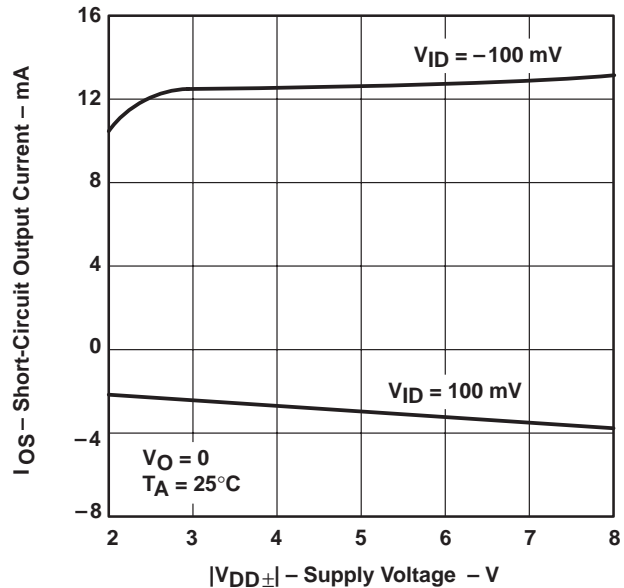

Figure 20

† Data at high and low temperatures are applicable only within the rated operating free-air temperature ranges of the various devices.

TYPICAL CHARACTERISTICS

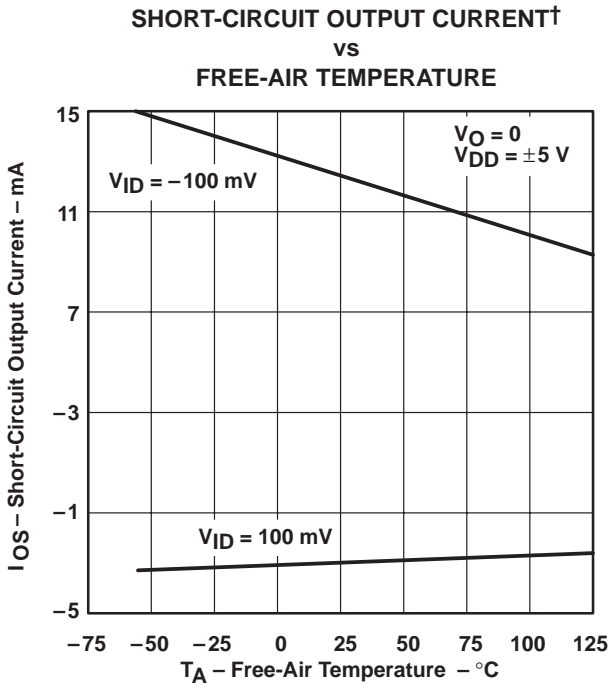

Figure 21

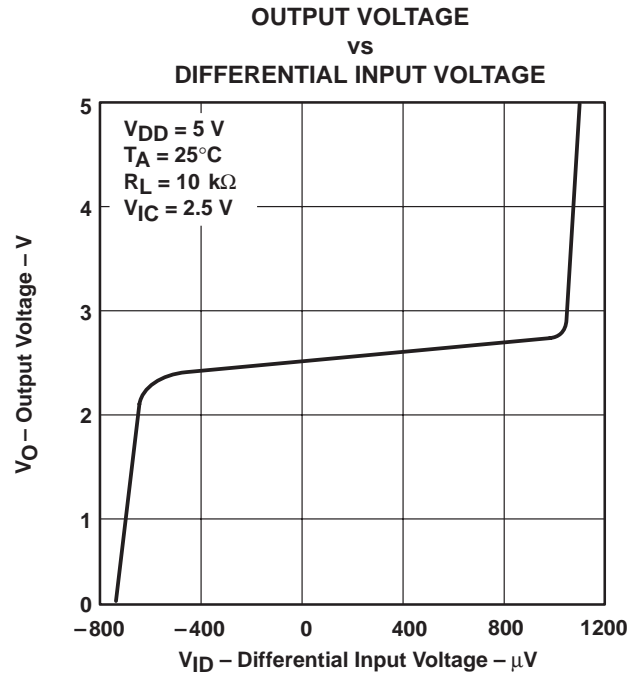

Figure 22

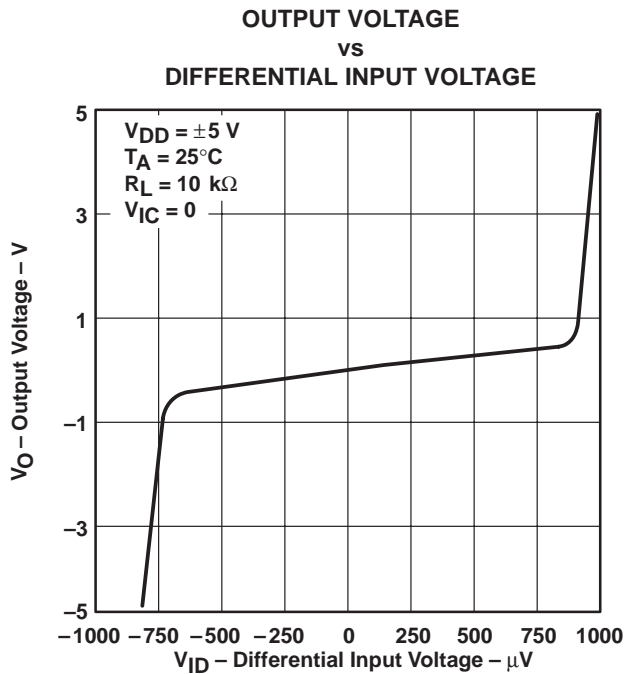

Figure 23

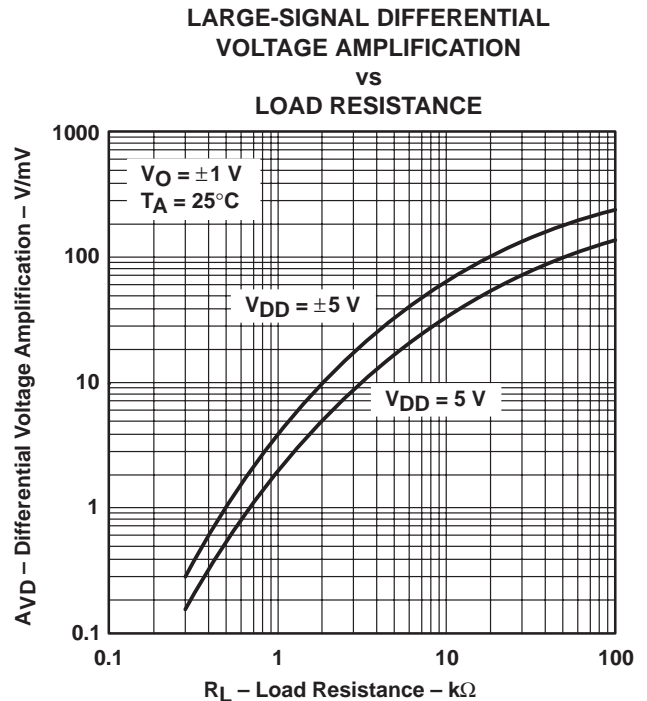

Figure 24

† Data at high and low temperatures are applicable only within the rated operating free-air temperature ranges of the various devices.

TYPICAL CHARACTERISTICS

LARGE-SIGNAL DIFFERENTIAL VOLTAGE  
 AMPLIFICATION AND PHASE MARGIN

vs  
 FREQUENCY

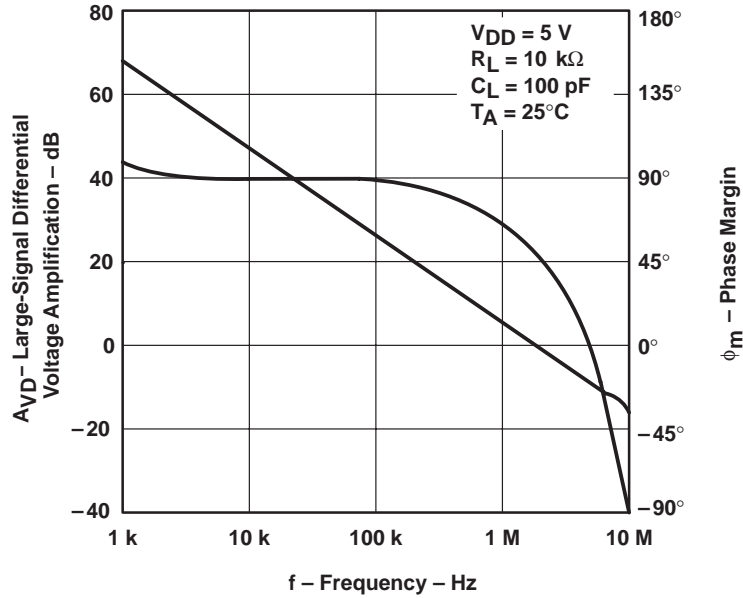

Figure 25

LARGE-SIGNAL DIFFERENTIAL VOLTAGE  
 AMPLIFICATION AND PHASE MARGIN

vs  
 FREQUENCY

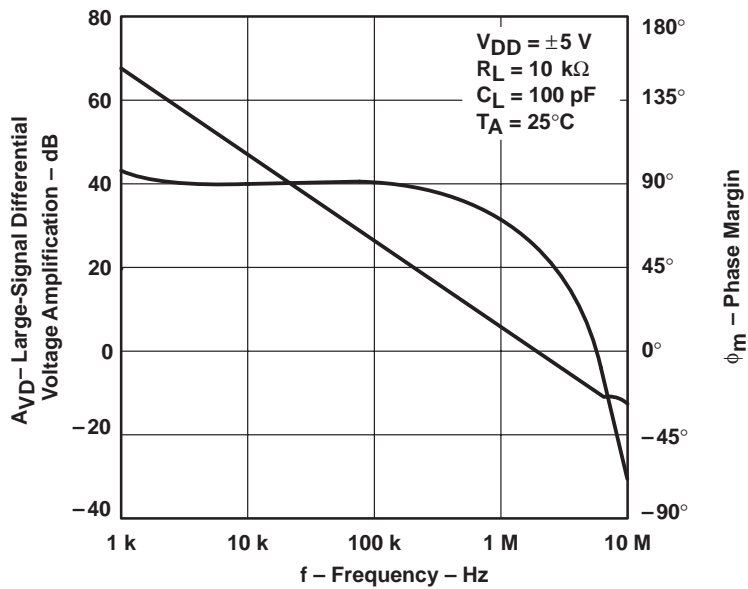
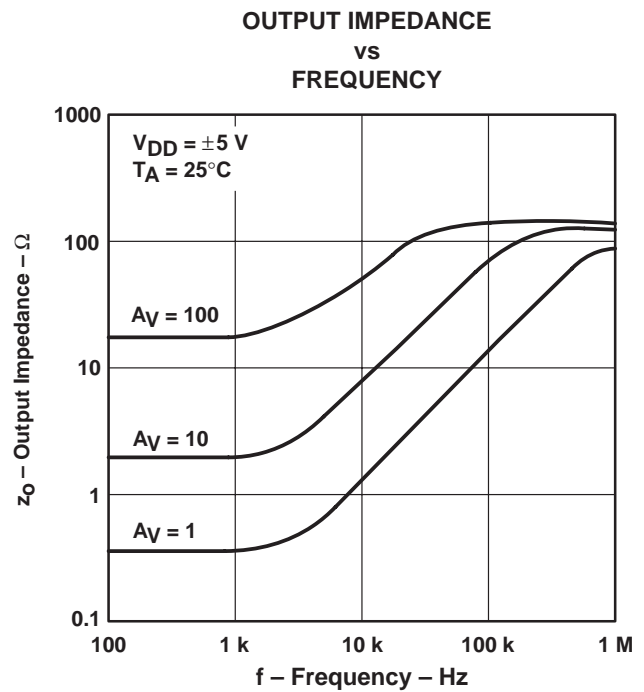
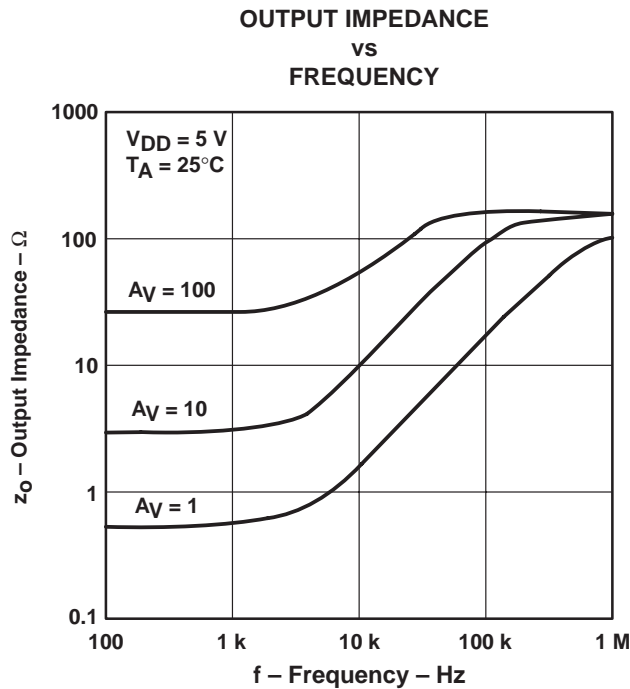
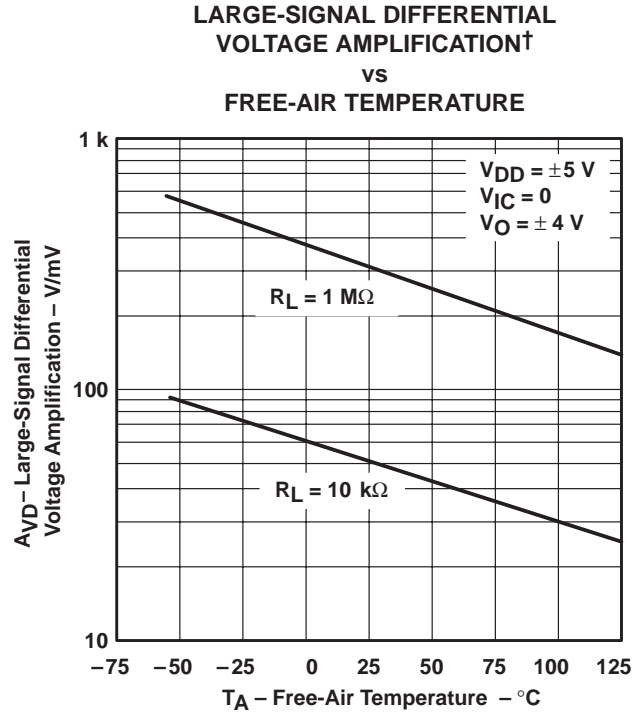
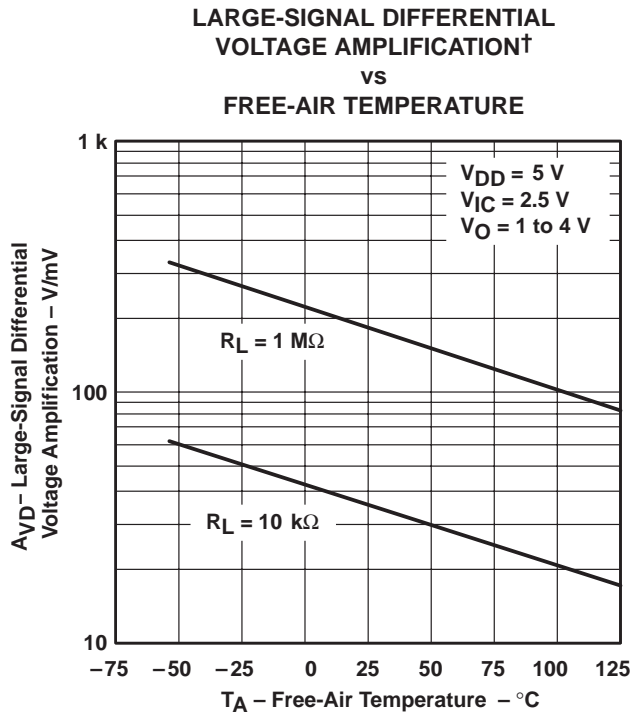

Figure 26

TYPICAL CHARACTERISTICS



† Data at high and low temperatures are applicable only within the rated operating free-air temperature ranges of the various devices.

TYPICAL CHARACTERISTICS

COMMON-MODE REJECTION RATIO  
 VS  
 FREQUENCY

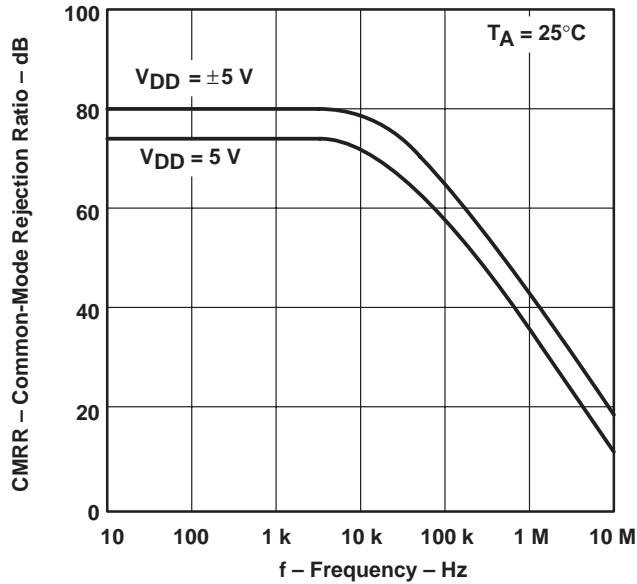

Figure 31

COMMON-MODE REJECTION RATIO  
 VS  
 FREE-AIR TEMPERATURE

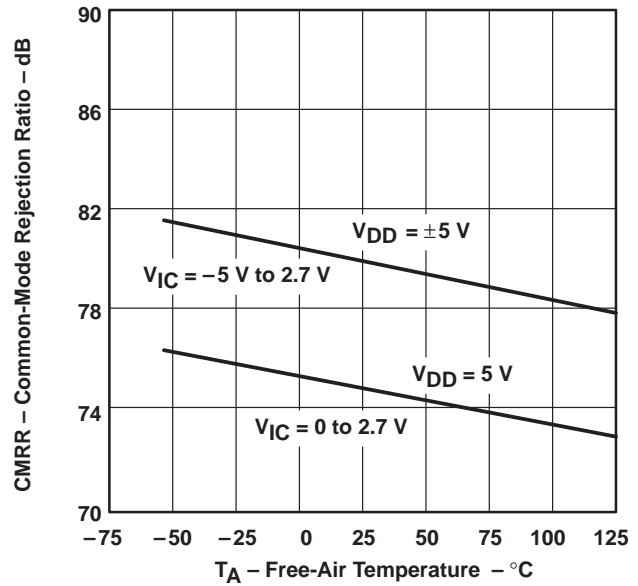

Figure 32

SUPPLY-VOLTAGE REJECTION RATIO  
 VS  
 FREQUENCY

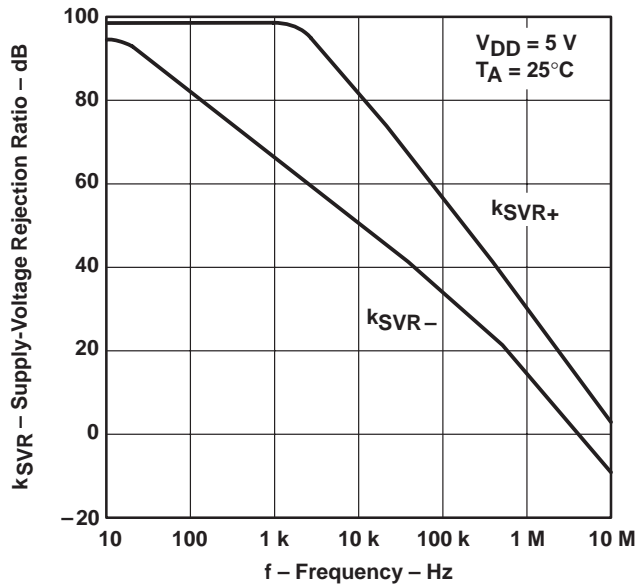

Figure 33

SUPPLY-VOLTAGE REJECTION RATIO  
 VS  
 FREQUENCY

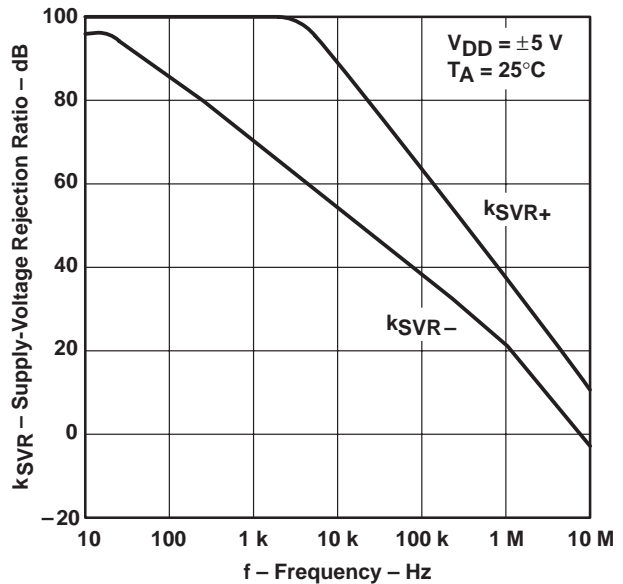
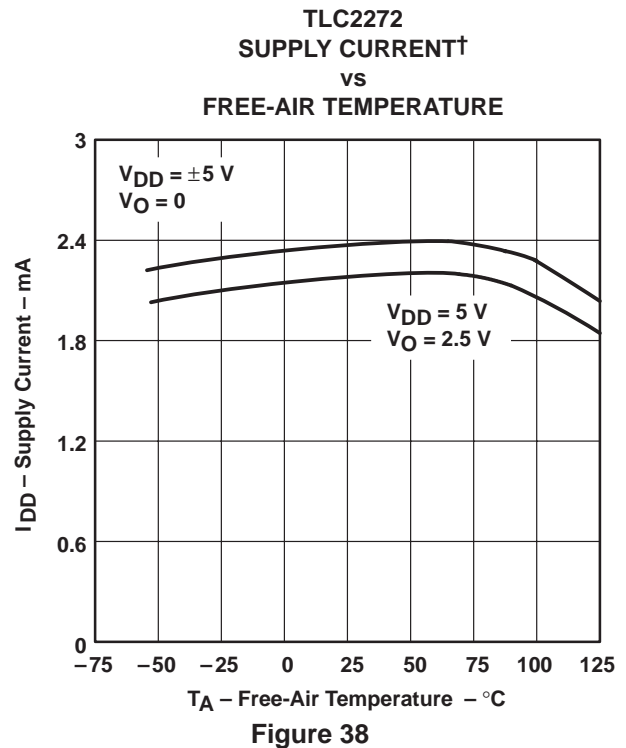
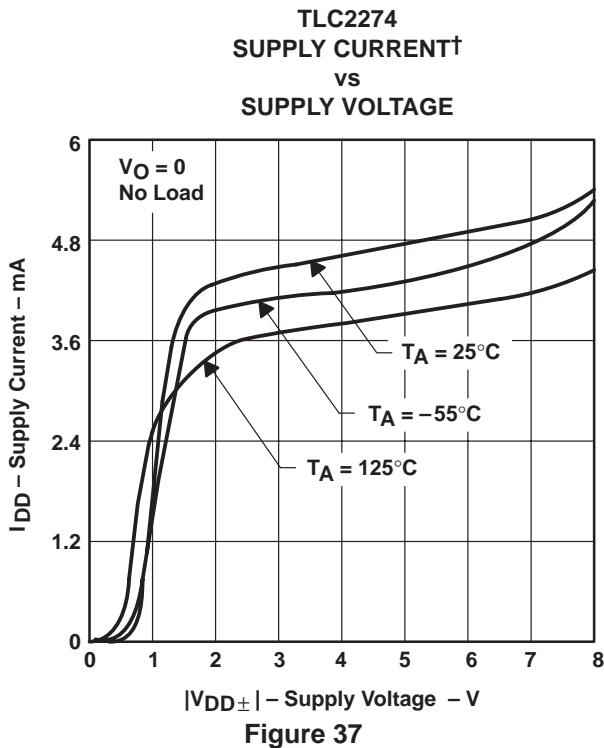
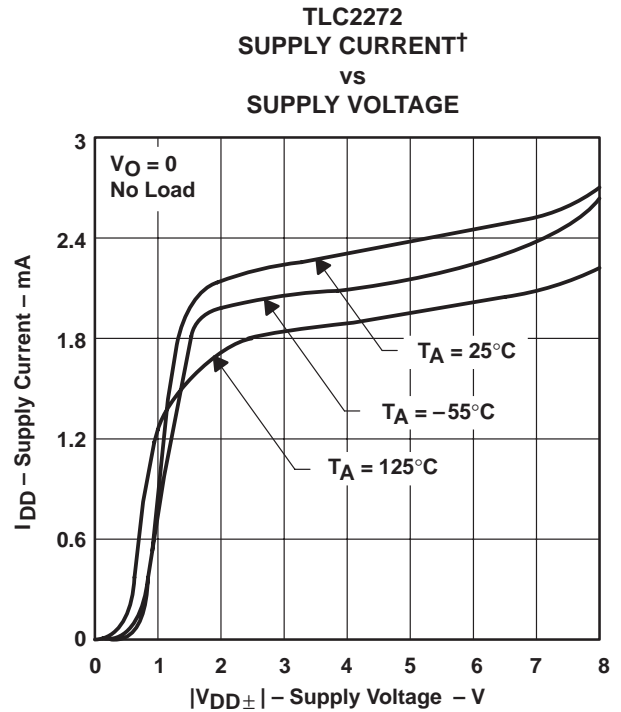
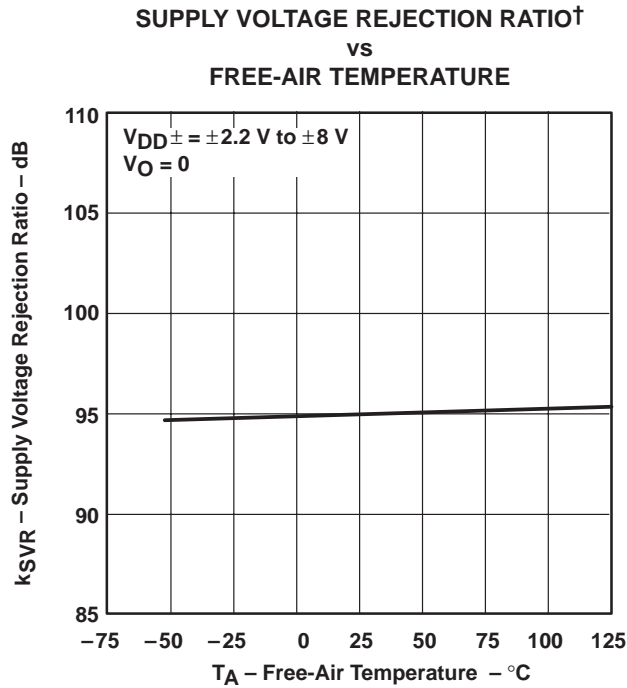

Figure 34

TYPICAL CHARACTERISTICS



† Data at high and low temperatures are applicable only within the rated operating free-air temperature ranges of the various devices.

TYPICAL CHARACTERISTICS

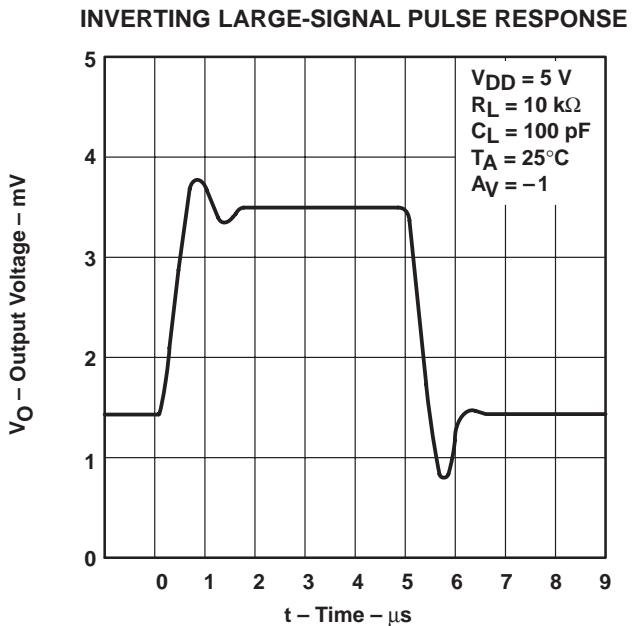
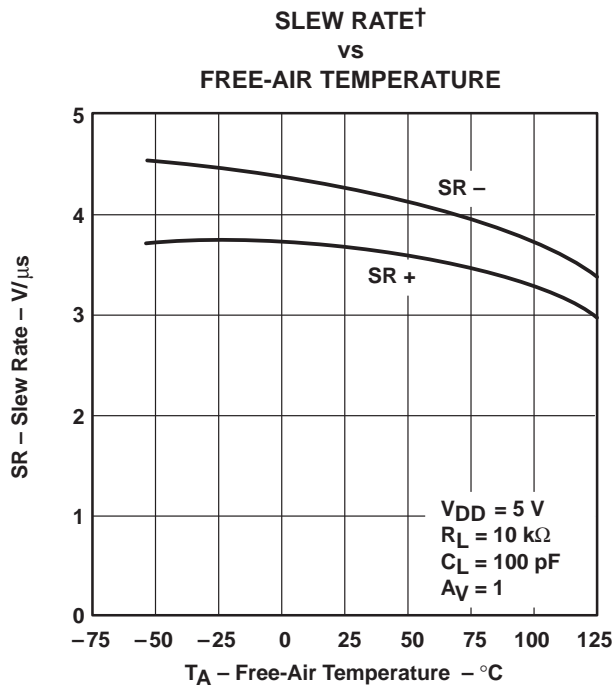
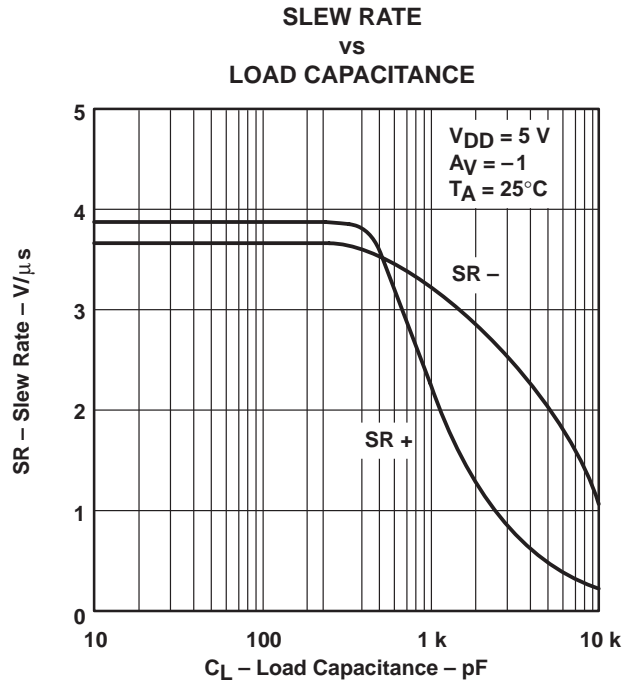
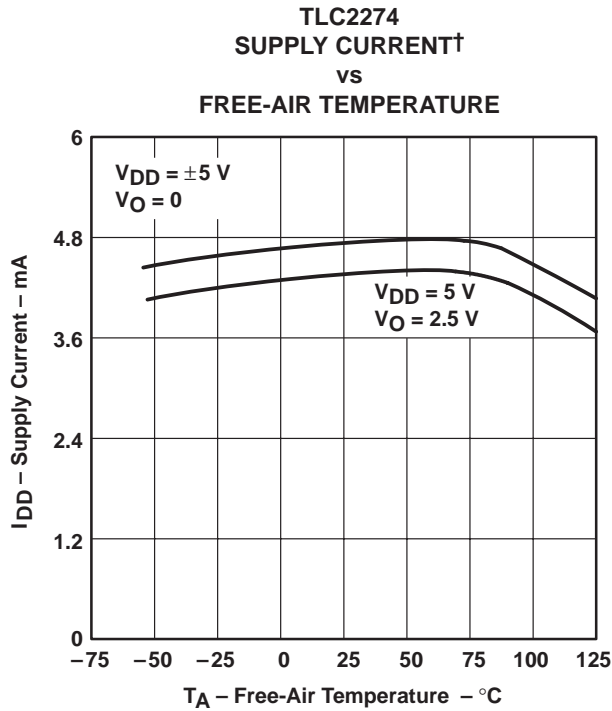

† Data at high and low temperatures are applicable only within the rated operating free-air temperature ranges of the various devices.



TYPICAL CHARACTERISTICS

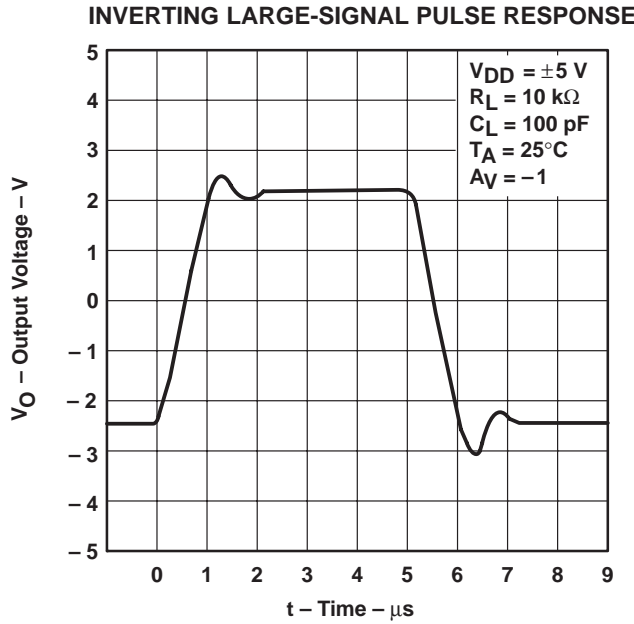

Figure 43

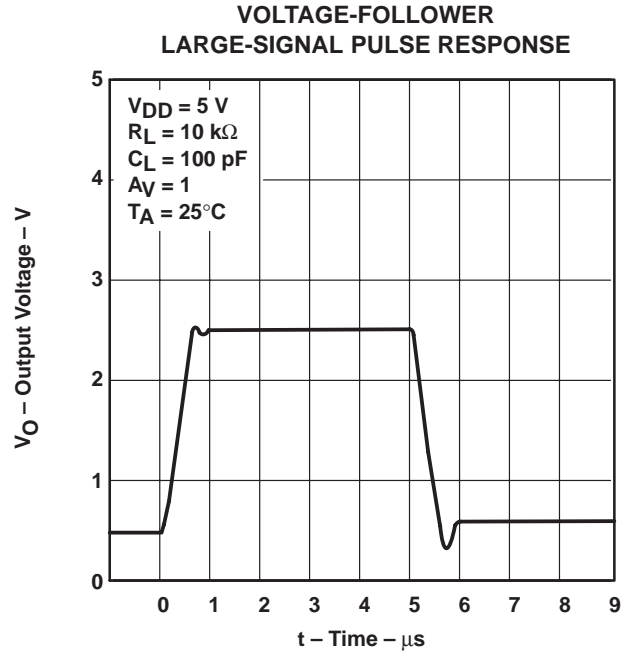

Figure 44

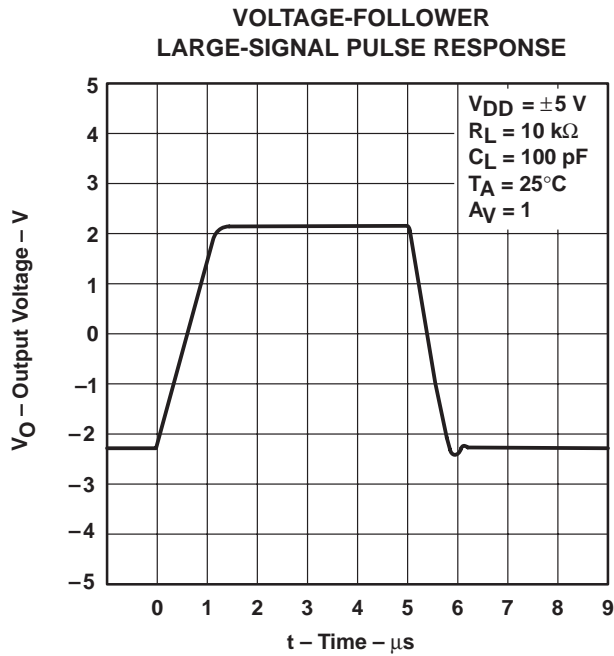

Figure 45

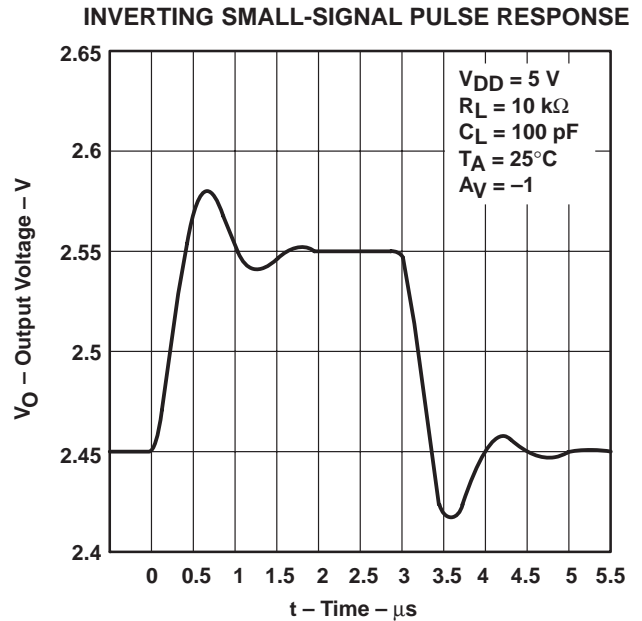

Figure 46

TYPICAL CHARACTERISTICS

INVERTING SMALL-SIGNAL PULSE RESPONSE

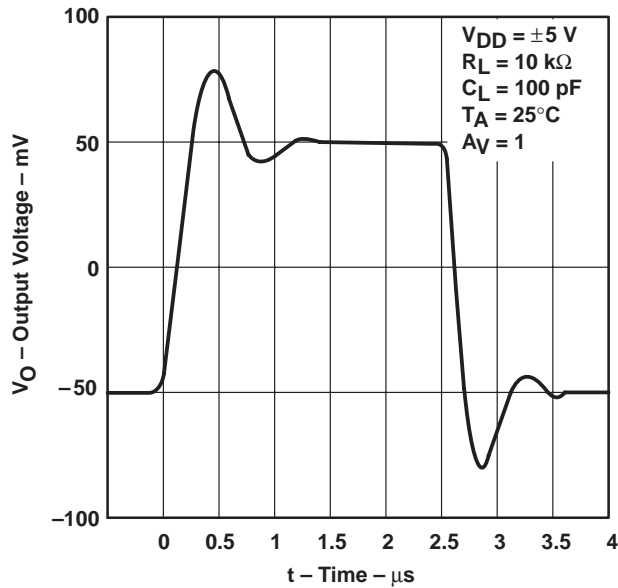

Figure 47

VOLTAGE-FOLLOWER SMALL-SIGNAL PULSE RESPONSE

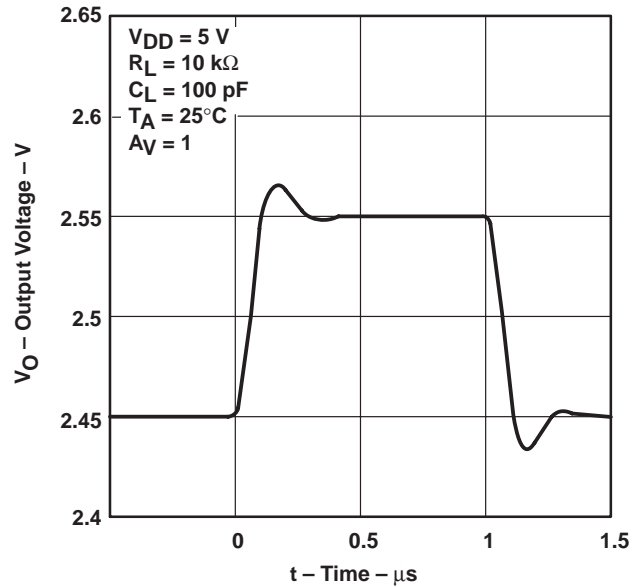

Figure 48

VOLTAGE-FOLLOWER SMALL-SIGNAL PULSE RESPONSE

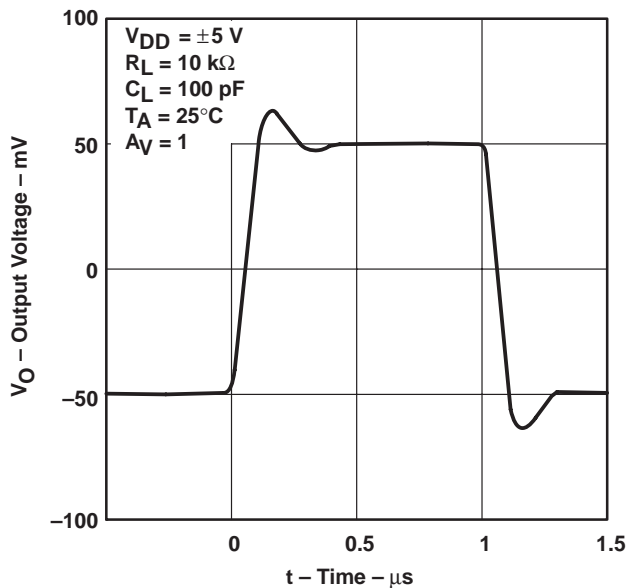

Figure 49

EQUIVALENT INPUT NOISE VOLTAGE VS FREQUENCY

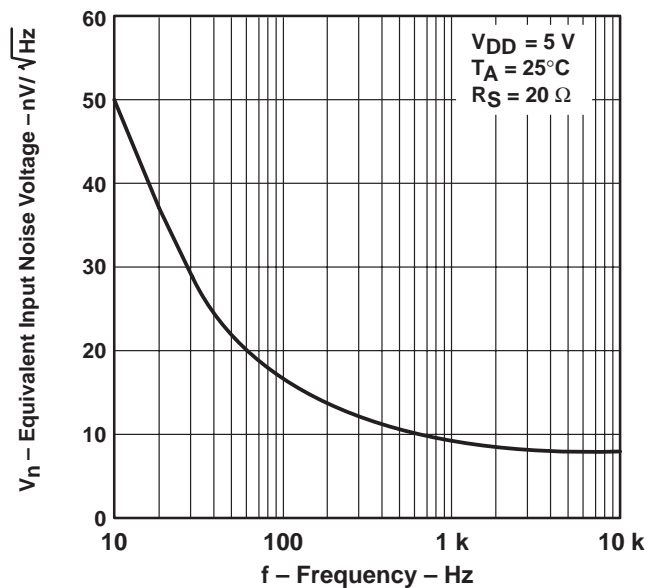

Figure 50

TYPICAL CHARACTERISTICS

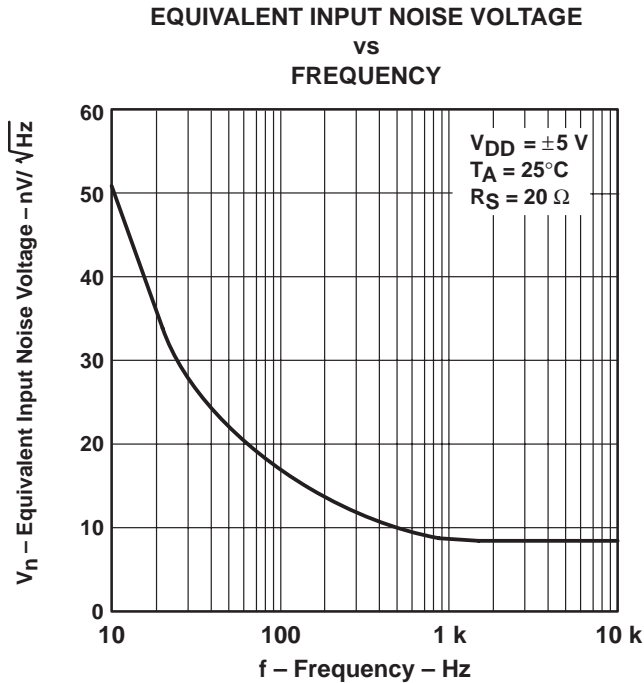

Figure 51

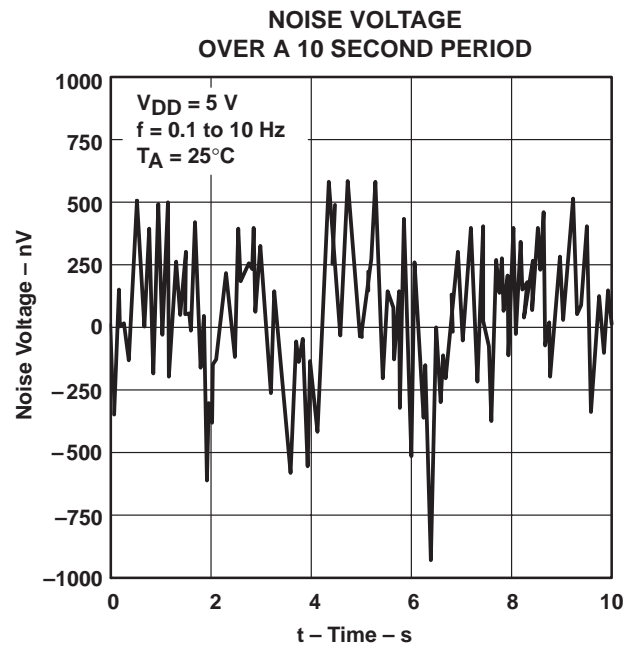

Figure 52

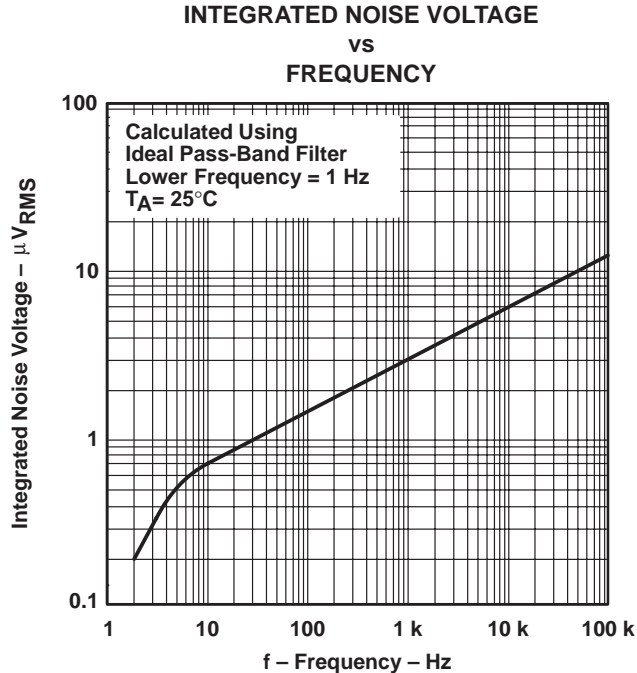

Figure 53

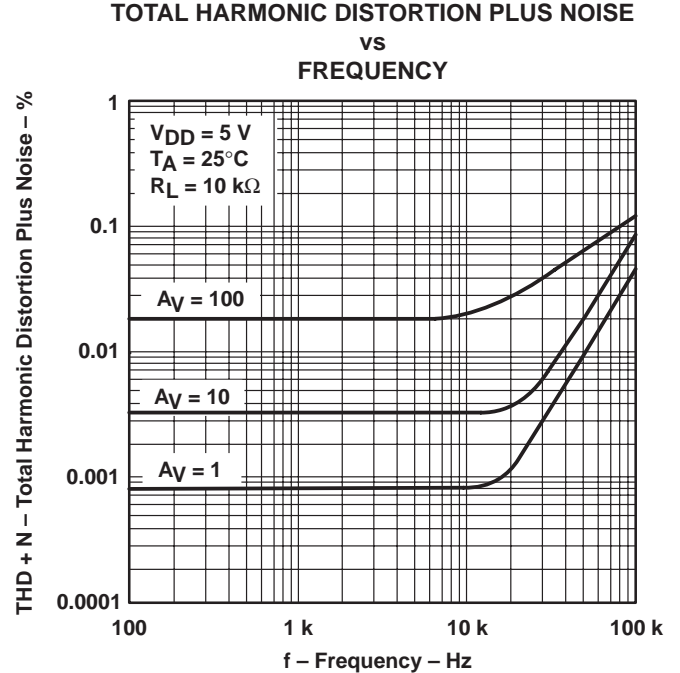

Figure 54

TYPICAL CHARACTERISTICS

GAIN-BANDWIDTH PRODUCT  
 vs  
 SUPPLY VOLTAGE

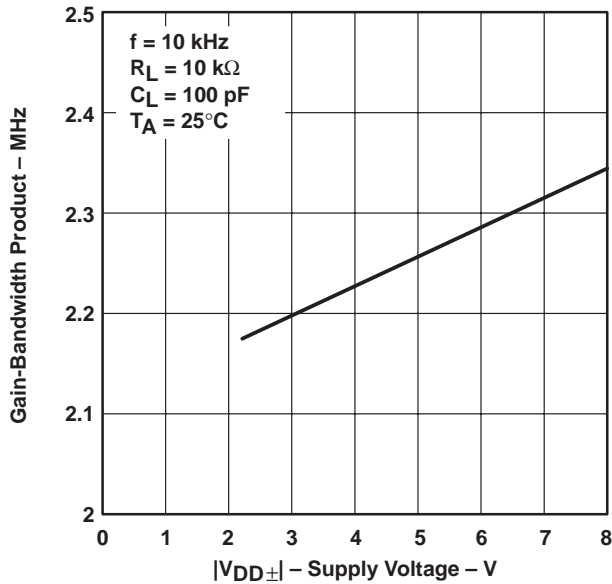

Figure 55

GAIN-BANDWIDTH PRODUCT†  
 vs  
 FREE-AIR TEMPERATURE

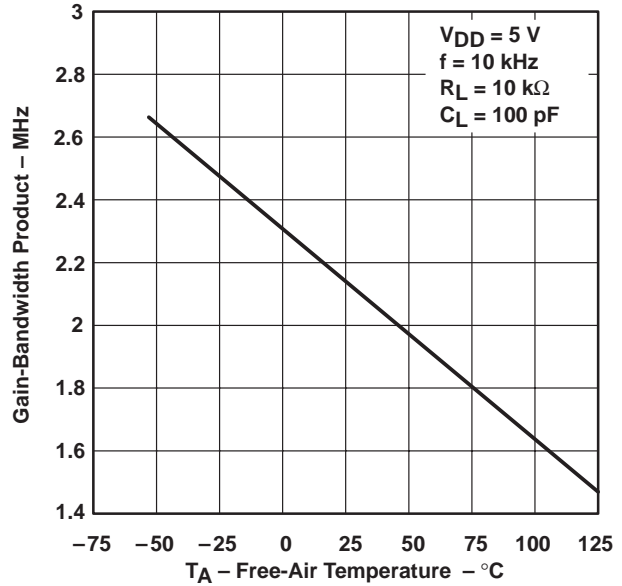

Figure 56

PHASE MARGIN  
 vs  
 LOAD CAPACITANCE

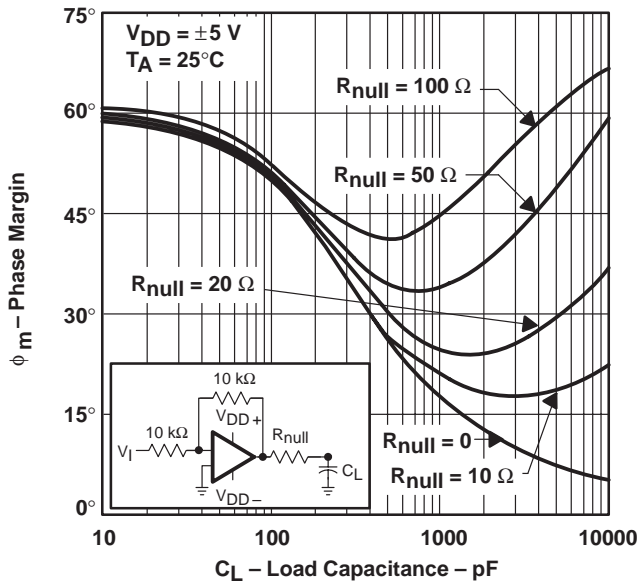

Figure 57

GAIN MARGIN  
 vs  
 LOAD CAPACITANCE

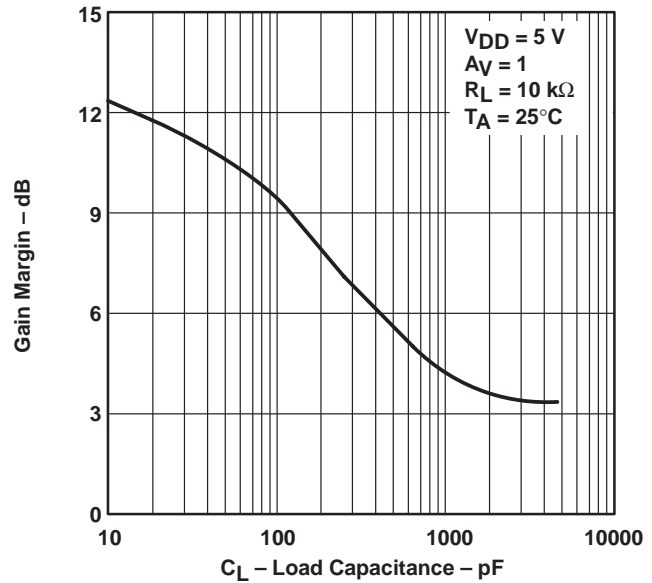

Figure 58

† Data at high and low temperatures are applicable only within the rated operating free-air temperature ranges of the various devices.

## APPLICATION INFORMATION

### macromodel information

Macromodel information provided was derived using Microsim *Parts*™, the model generation software used with Microsim *PSpice*™. The Boyle macromodel (see Note 5) and subcircuit in Figure 59 were generated using the TLC227x typical electrical and operating characteristics at  $T_A = 25^\circ\text{C}$ . Using this information, output simulations of the following key parameters can be generated to a tolerance of 20% (in most cases):

- Maximum positive output voltage swing
- Maximum negative output voltage swing
- Slew rate
- Quiescent power dissipation
- Input bias current
- Open-loop voltage amplification
- Unity gain frequency
- Common-mode rejection ratio
- Phase margin
- DC output resistance
- AC output resistance
- Short-circuit output current limit

NOTE 5: G. R. Boyle, B. M. Cohn, D. O. Pederson, and J. E. Solomon, "Macromodeling of Intergrated Circuit Operational Amplifiers", *IEEE Journal of Solid-State Circuits*, SC-9, 353 (1974).

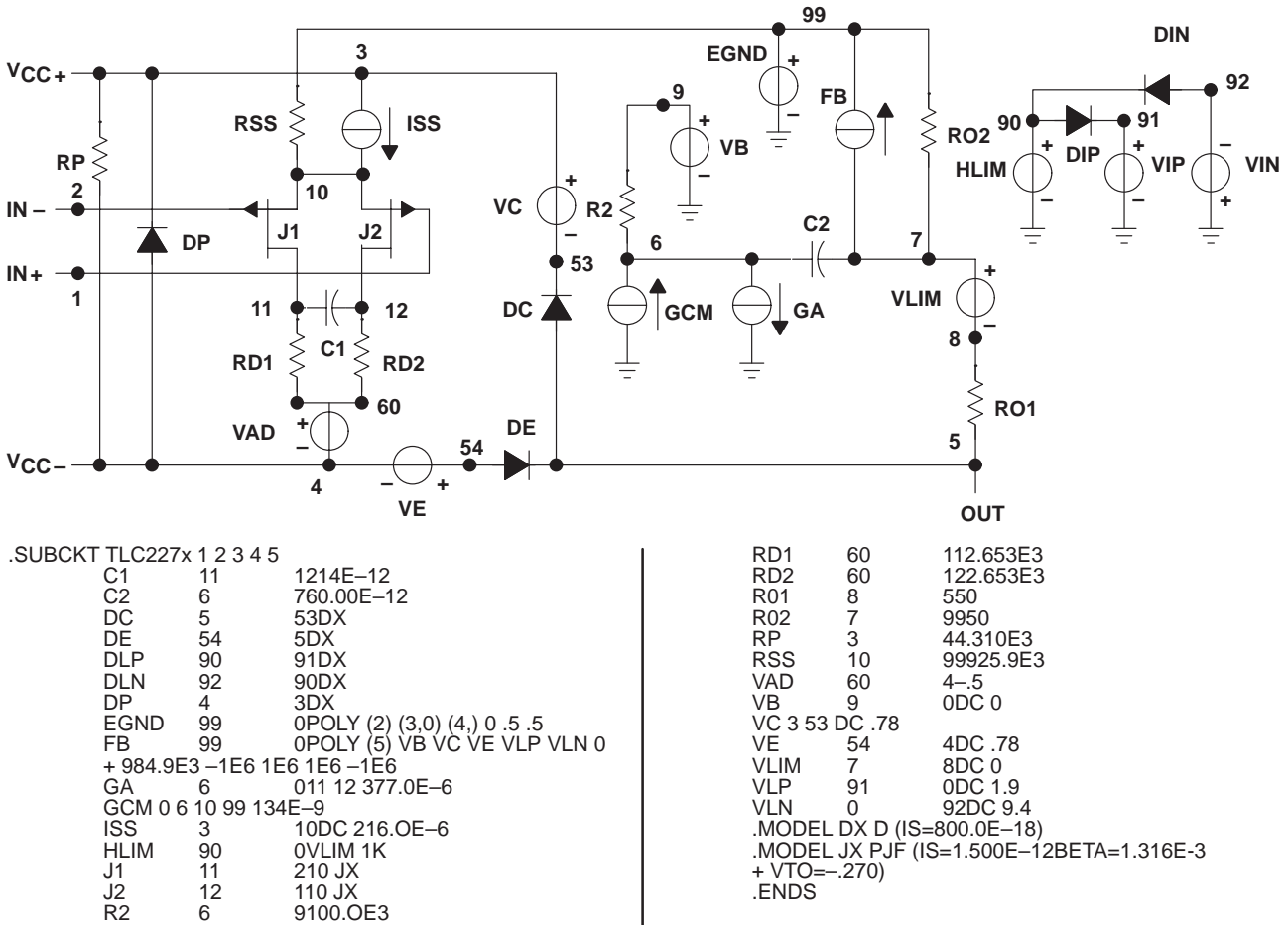

Figure 59. Boyle Macromodel and Subcircuit

*PSpice* and *Parts* are trademarks of MicroSim Corporation.

Macromodels, simulation models, or other models provided by TI, directly or indirectly, are not warranted by TI as fully representing all of the specification and operating characteristics of the semiconductor product to which the model relates.



**TLC227x, TLC227xA**  
**Advanced LinCMOS™ RAIL-TO-RAIL**  
**OPERATIONAL AMPLIFIERS**

SLOS190B – FEBRUARY 1997 – REVISED JULY 1999

**MECHANICAL DATA**

**D (R-PDSO-G\*\*)**

**PLASTIC SMALL-OUTLINE PACKAGE**

14 PIN SHOWN

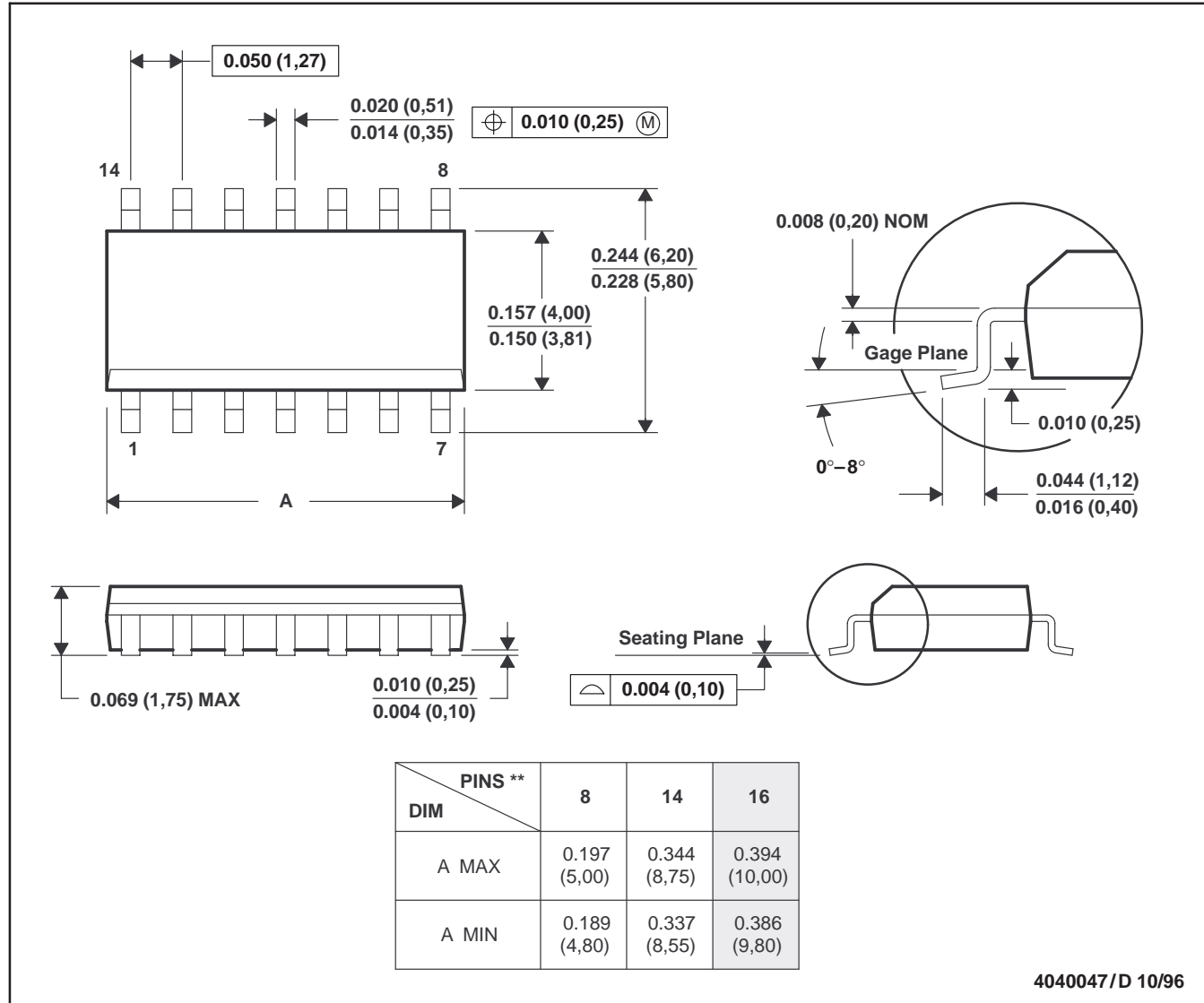

- NOTES: A. All linear dimensions are in inches (millimeters).  
 B. This drawing is subject to change without notice.  
 C. Body dimensions do not include mold flash or protrusion, not to exceed 0.006 (0,15).  
 D. Falls within JEDEC MS-012

MECHANICAL DATA

FK (S-CQCC-N\*\*)

LEADLESS CERAMIC CHIP CARRIER

28 TERMINAL SHOWN

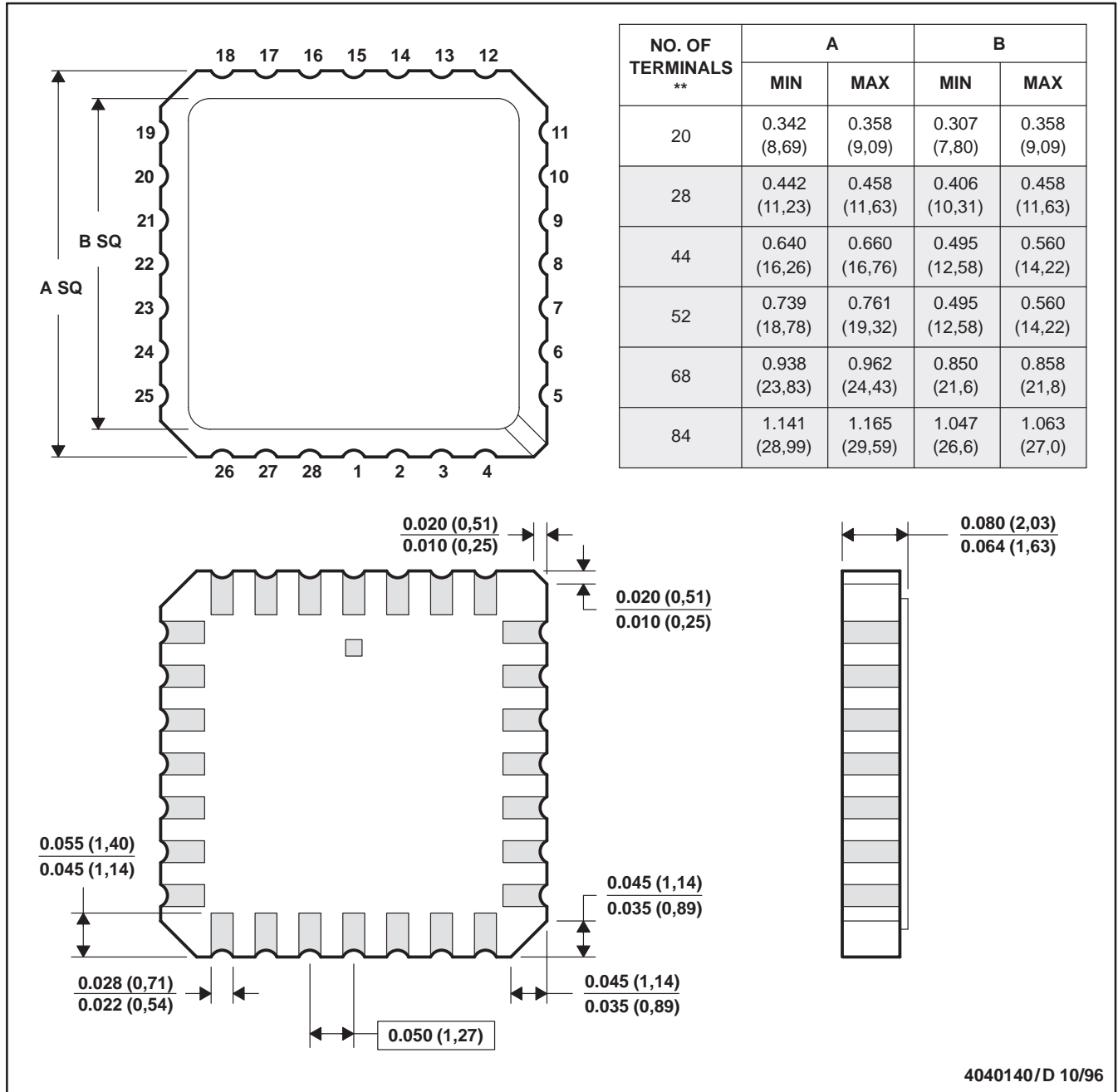

4040140/D 10/96

- NOTES: A. All linear dimensions are in inches (millimeters).  
 B. This drawing is subject to change without notice.  
 C. This package can be hermetically sealed with a metal lid.  
 D. The terminals are gold plated.  
 E. Falls within JEDEC MS-004

**TLC227x, TLC227xA**  
**Advanced LinCMOS™ RAIL-TO-RAIL**  
**OPERATIONAL AMPLIFIERS**

SLOS190B – FEBRUARY 1997 – REVISED JULY 1999

**MECHANICAL DATA**

**J (R-GDIP-T\*\*)**

**CERAMIC DUAL-IN-LINE PACKAGE**

14 PIN SHOWN

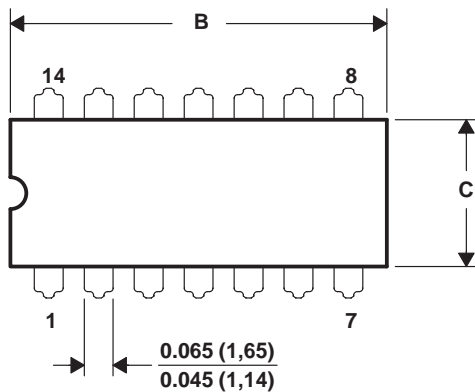

DIM \ PINS **	14	16	18	20
	A MAX	0.310 (7,87)	0.310 (7,87)	0.310 (7,87)
A MIN	0.290 (7,37)	0.290 (7,37)	0.290 (7,37)	0.290 (7,37)
B MAX	0.785 (19,94)	0.785 (19,94)	0.910 (23,10)	0.975 (24,77)
B MIN	0.755 (19,18)	0.755 (19,18)	—	0.930 (23,62)
C MAX	0.300 (7,62)	0.300 (7,62)	0.300 (7,62)	0.300 (7,62)
C MIN	0.245 (6,22)	0.245 (6,22)	0.245 (6,22)	0.245 (6,22)

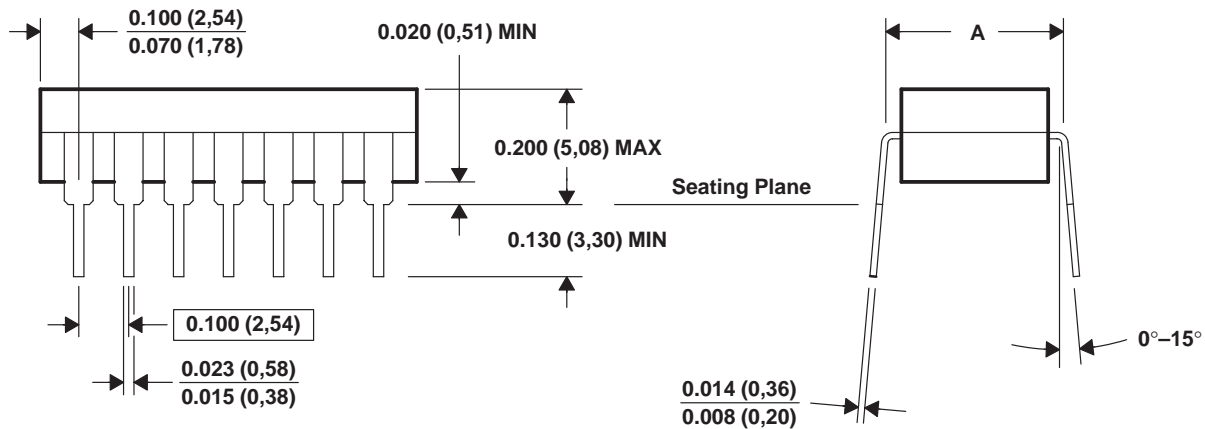

4040083/D 08/98

- NOTES: A. All linear dimensions are in inches (millimeters).  
 B. This drawing is subject to change without notice.  
 C. This package can be hermetically sealed with a ceramic lid using glass frit.  
 D. Index point is provided on cap for terminal identification only on press ceramic glass frit seal only.  
 E. Falls within MIL STD 1835 GDIP1-T14, GDIP1-T16, GDIP1-T18, GDIP1-T20, and GDIP1-T22.



MECHANICAL DATA

N (R-PDIP-T\*\*)

PLASTIC DUAL-IN-LINE PACKAGE

16 PIN SHOWN

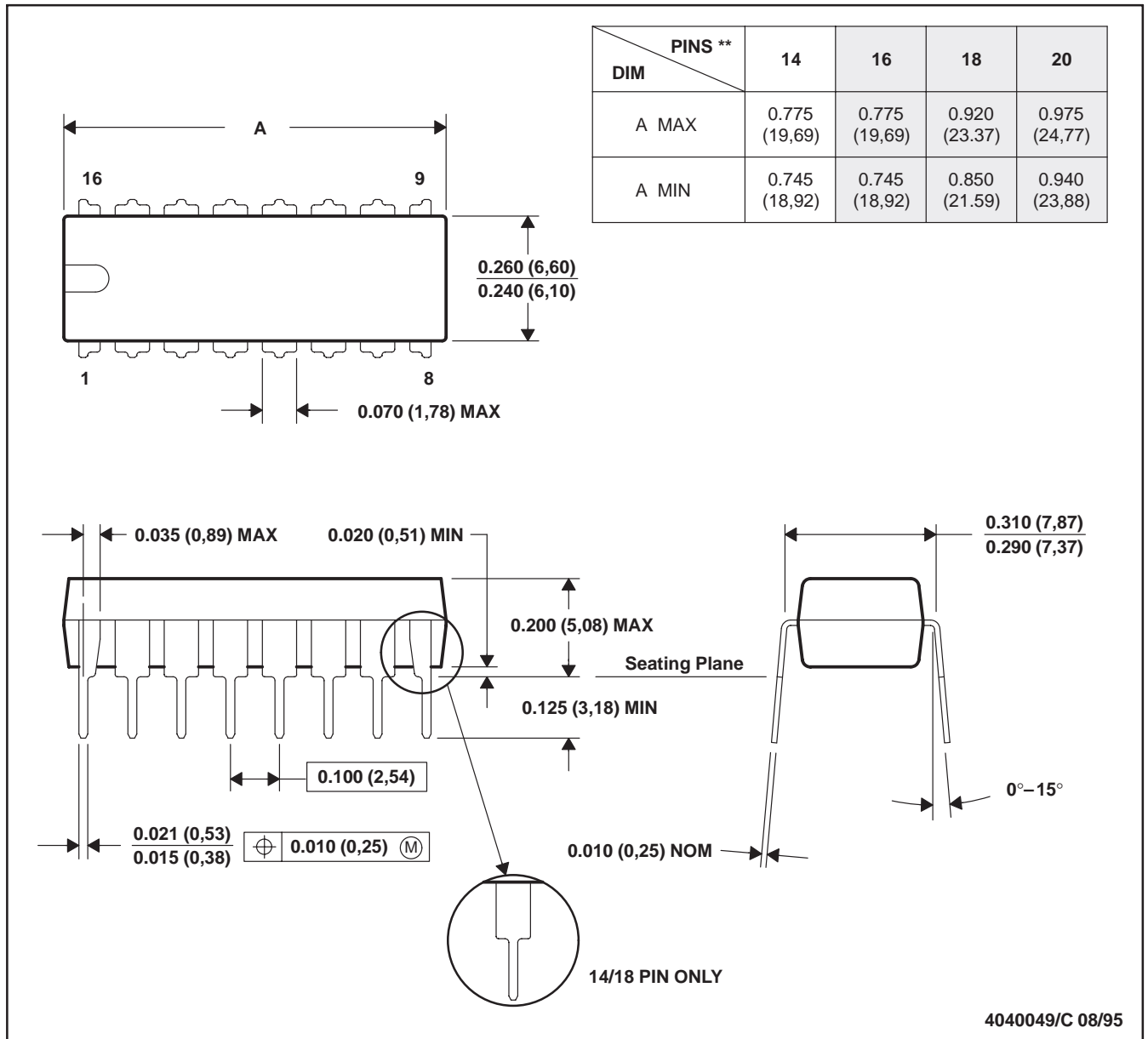

- NOTES: A. All linear dimensions are in inches (millimeters).  
 B. This drawing is subject to change without notice.  
 C. Falls within JEDEC MS-001 (20 pin package is shorter than MS-001.)

**TLC227x, TLC227xA**  
**Advanced LinCMOS™ RAIL-TO-RAIL**  
**OPERATIONAL AMPLIFIERS**

SLOS190B – FEBRUARY 1997 – REVISED JULY 1999

**MECHANICAL DATA**

**P (R-PDIP-T8)**

**PLASTIC DUAL-IN-LINE PACKAGE**

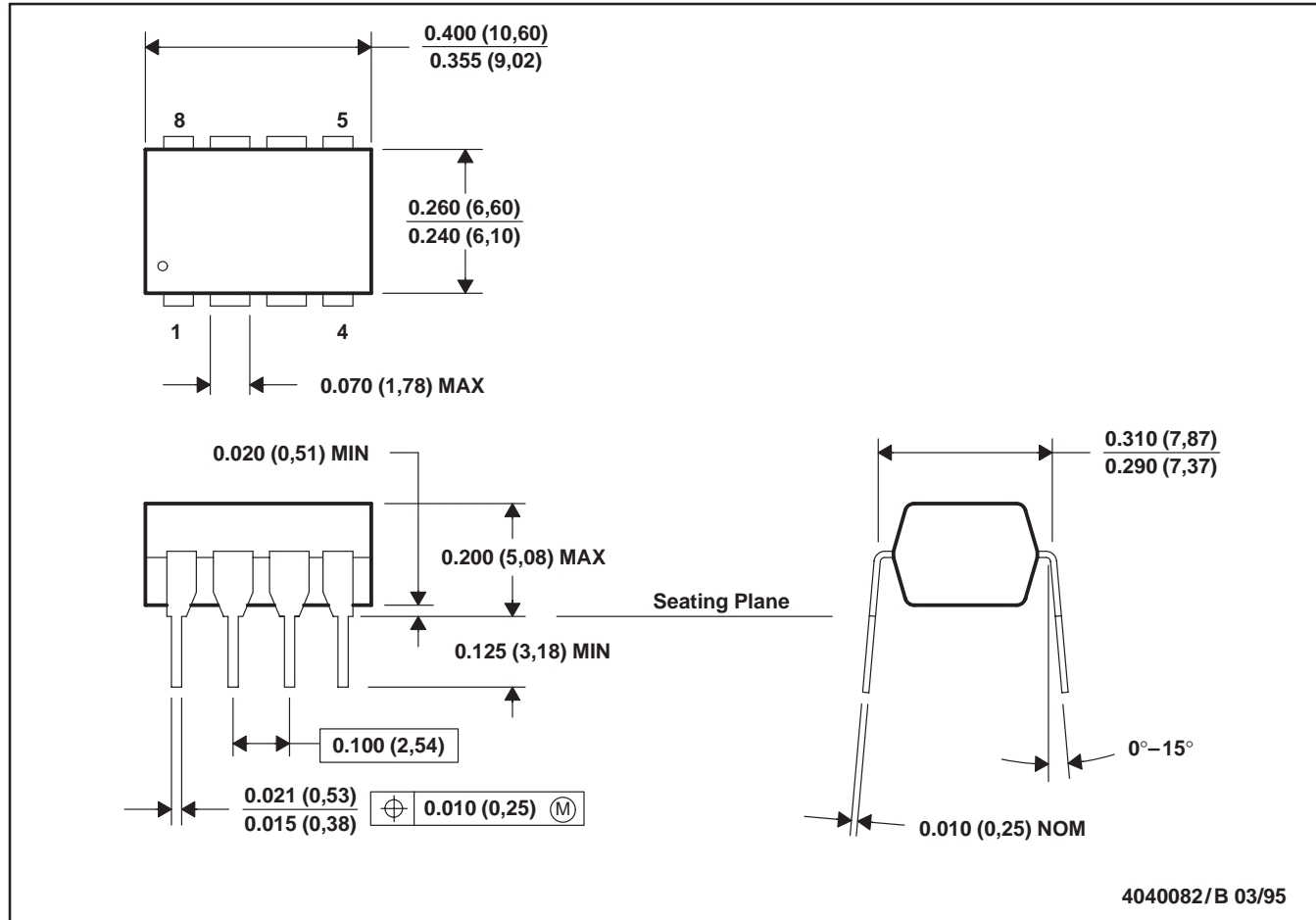

- NOTES: A. All linear dimensions are in inches (millimeters).  
 B. This drawing is subject to change without notice.  
 C. Falls within JEDEC MS-001

MECHANICAL DATA

PW (R-PDSO-G\*\*)

PLASTIC SMALL-OUTLINE PACKAGE

14 PIN SHOWN

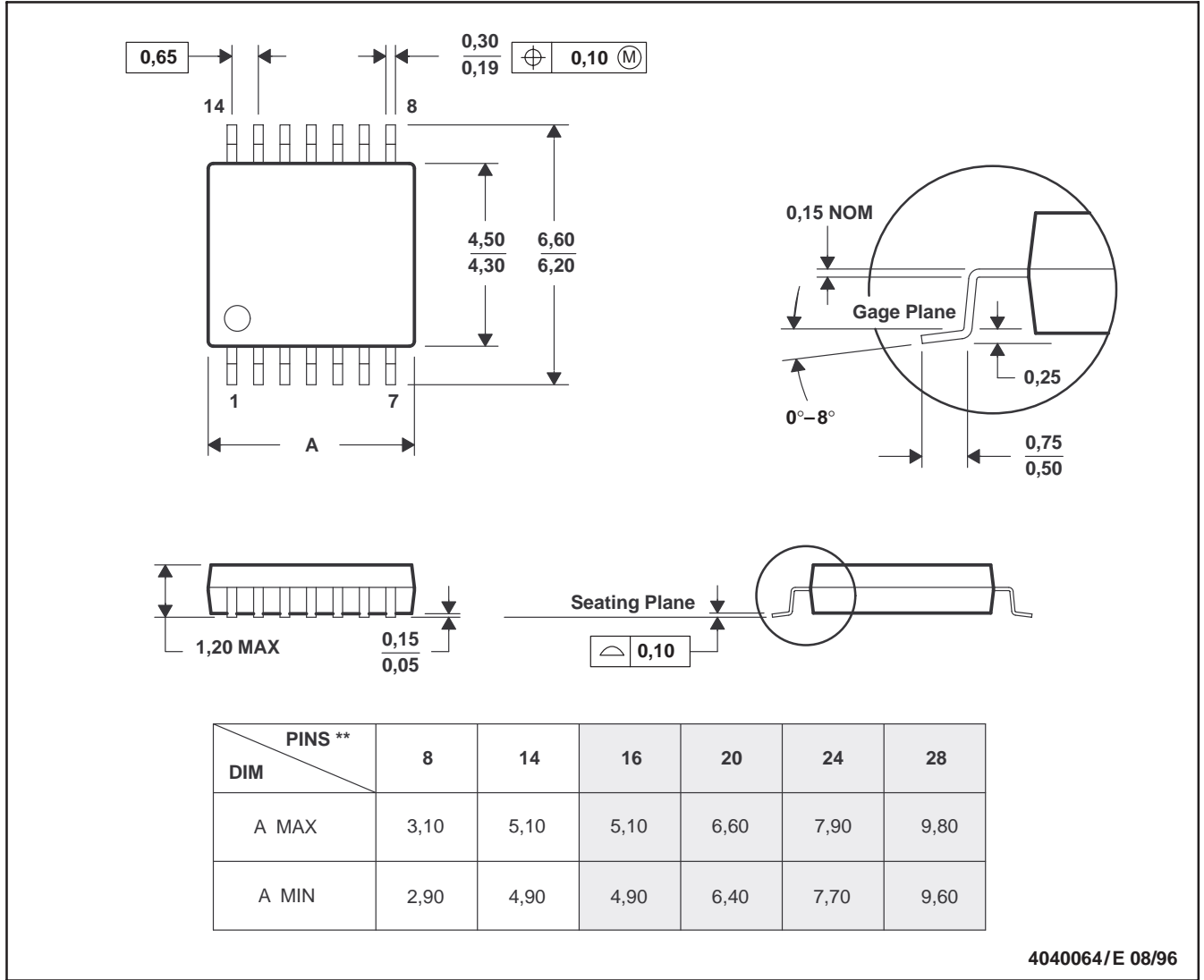

4040064/E 08/96

- NOTES: A. All linear dimensions are in millimeters.  
 B. This drawing is subject to change without notice.  
 C. Body dimensions do not include mold flash or protrusion not to exceed 0,15.  
 D. Falls within JEDEC MO-153

## IMPORTANT NOTICE

Texas Instruments and its subsidiaries (TI) reserve the right to make changes to their products or to discontinue any product or service without notice, and advise customers to obtain the latest version of relevant information to verify, before placing orders, that information being relied on is current and complete. All products are sold subject to the terms and conditions of sale supplied at the time of order acknowledgement, including those pertaining to warranty, patent infringement, and limitation of liability.

TI warrants performance of its semiconductor products to the specifications applicable at the time of sale in accordance with TI's standard warranty. Testing and other quality control techniques are utilized to the extent TI deems necessary to support this warranty. Specific testing of all parameters of each device is not necessarily performed, except those mandated by government requirements.

CERTAIN APPLICATIONS USING SEMICONDUCTOR PRODUCTS MAY INVOLVE POTENTIAL RISKS OF DEATH, PERSONAL INJURY, OR SEVERE PROPERTY OR ENVIRONMENTAL DAMAGE ("CRITICAL APPLICATIONS"). TI SEMICONDUCTOR PRODUCTS ARE NOT DESIGNED, AUTHORIZED, OR WARRANTED TO BE SUITABLE FOR USE IN LIFE-SUPPORT DEVICES OR SYSTEMS OR OTHER CRITICAL APPLICATIONS. INCLUSION OF TI PRODUCTS IN SUCH APPLICATIONS IS UNDERSTOOD TO BE FULLY AT THE CUSTOMER'S RISK.

In order to minimize risks associated with the customer's applications, adequate design and operating safeguards must be provided by the customer to minimize inherent or procedural hazards.

TI assumes no liability for applications assistance or customer product design. TI does not warrant or represent that any license, either express or implied, is granted under any patent right, copyright, mask work right, or other intellectual property right of TI covering or relating to any combination, machine, or process in which such semiconductor products or services might be or are used. TI's publication of information regarding any third party's products or services does not constitute TI's approval, warranty or endorsement thereof.