

TLC254, TLC254A, TLC254B, TLC254Y, TLC25L4, TLC25L4A, TLC25L4B TLC25L4Y, TLC25M4, TLC25M4A, TLC25M4B, TLC25M4Y LinCMOS™ QUAD OPERATIONAL AMPLIFIERS

SLOS003F – JUNE 1983 – REVISED AUGUST 1994

- **A-Suffix Versions Offer 5-mV V_{IO}**
- **B-Suffix Versions Offer 2-mV V_{IO}**
- **Wide Range of Supply Voltages
1.4 V to 16 V**
- **True Single-Supply Operation**
- **Common-Mode Input Voltage Includes the
Negative Rail**
- **Low Noise . . . 25 nV/ $\sqrt{\text{Hz}}$ Typ at $f = 1$ kHz
(High-Bias Version)**

**D, N, OR PW PACKAGE
(TOP VIEW)**

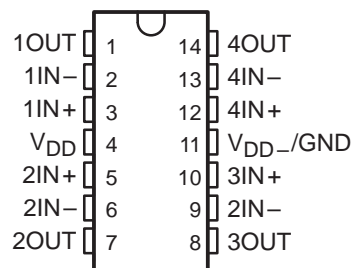

description

The TLC254, TLC254A, TLC254B, TLC25L4, TLC25L4A, TLC25L4B, TLC25M4, TLC25M4A and TLC25M4B are low-cost, low-power quad operational amplifiers designed to operate with single or dual supplies. These devices utilize the Texas Instruments silicon gate LinCMOS™

process, giving them stable input-offset voltages that are available in selected grades of 2, 5, or 10 mV maximum, very high input impedances, and extremely low input offset and bias currents. Because the input common-mode range extends to the negative rail and the power consumption is extremely low, this series is ideally suited for battery-powered or energy-conserving applications. The series offers operation down to a 1.4-V supply, is stable at unity gain, and has excellent noise characteristics.

symbol (each amplifier)

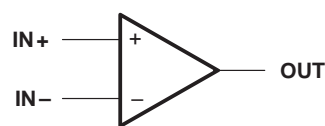

These devices have internal electrostatic-discharge (ESD) protection circuits that prevent catastrophic failures at voltages up to 2000 V as tested under MIL-STD-883C, Method 3015.1. However, care should be exercised in handling these devices as exposure to ESD may result in degradation of the device parametric performance.

Because of the extremely high input impedance and low input bias and offset currents, applications for these devices include many areas that have previously been limited to BIFET and NFET product types. Any circuit using high-impedance elements and requiring small offset errors is a good candidate for cost-effective use of these devices. Many features associated with bipolar technology are available with LinCMOS operational amplifiers without the power penalties of traditional bipolar devices.

Available options

T_A	V_{IOmax} AT 25°C	PACKAGED DEVICES			CHIP FORM (Y)
		SMALL OUTLINE (D)	PLASTIC DIP (N)	TSSOP (PW)	
0°C to 70°C	10 mV	TLC254CD	TLC254CN	TLC254CPW	TLC254Y
	5 mV	TLC254ACD	TLC254ACN	—	—
	2 mV	TLC254BCD	TLC254BCN	—	—
	10 mV	TLC25L4CD	TLC25L4CN	TLC25L4CPW	TLC25L4Y
	5 mV	TLC25L4ACD	TLC25L4ACN	—	—
	2 mV	TLC25L2BCD	TLC25L4BCN	—	—
	10 mV	TLC25M4CD	TLC25M4CN	TLC25M4CPW	TLC25M4Y
	5 mV	TLC25M4ACD	TLC25M4ACN	—	—
	2 mV	TLC25M4BCD	TLC25M4BCN	—	—

The D package is available taped and reeled. Add the suffix R to the device type (e.g., TLC254CDR). Chips are tested at 25°C.

LinCMOS is a trademark of Texas Instruments Incorporated.

PRODUCTION DATA information is current as of publication date. Products conform to specifications per the terms of Texas Instruments standard warranty. Production processing does not necessarily include testing of all parameters.



POST OFFICE BOX 655303 • DALLAS, TEXAS 75265

Copyright © 1994, Texas Instruments Incorporated

TLC254, TLC254A, TLC254B, TLC254Y, TLC25L4, TLC25L4A, TLC25L4B
 TLC25L4Y, TLC25M4, TLC25M4A, TLC25M4B, TLC25M4Y
 LinCMOS™ QUAD OPERATIONAL AMPLIFIERS

SLOS003F – JUNE 1983 – REVISED AUGUST 1994

chip information

These chips, when properly assembled, display characteristics similar to the TLC25_4C. Thermal compression or ultrasonic bonding may be used on the doped-aluminum bonding pads. Chips may be mounted with conductive epoxy or a gold-silicon preform.

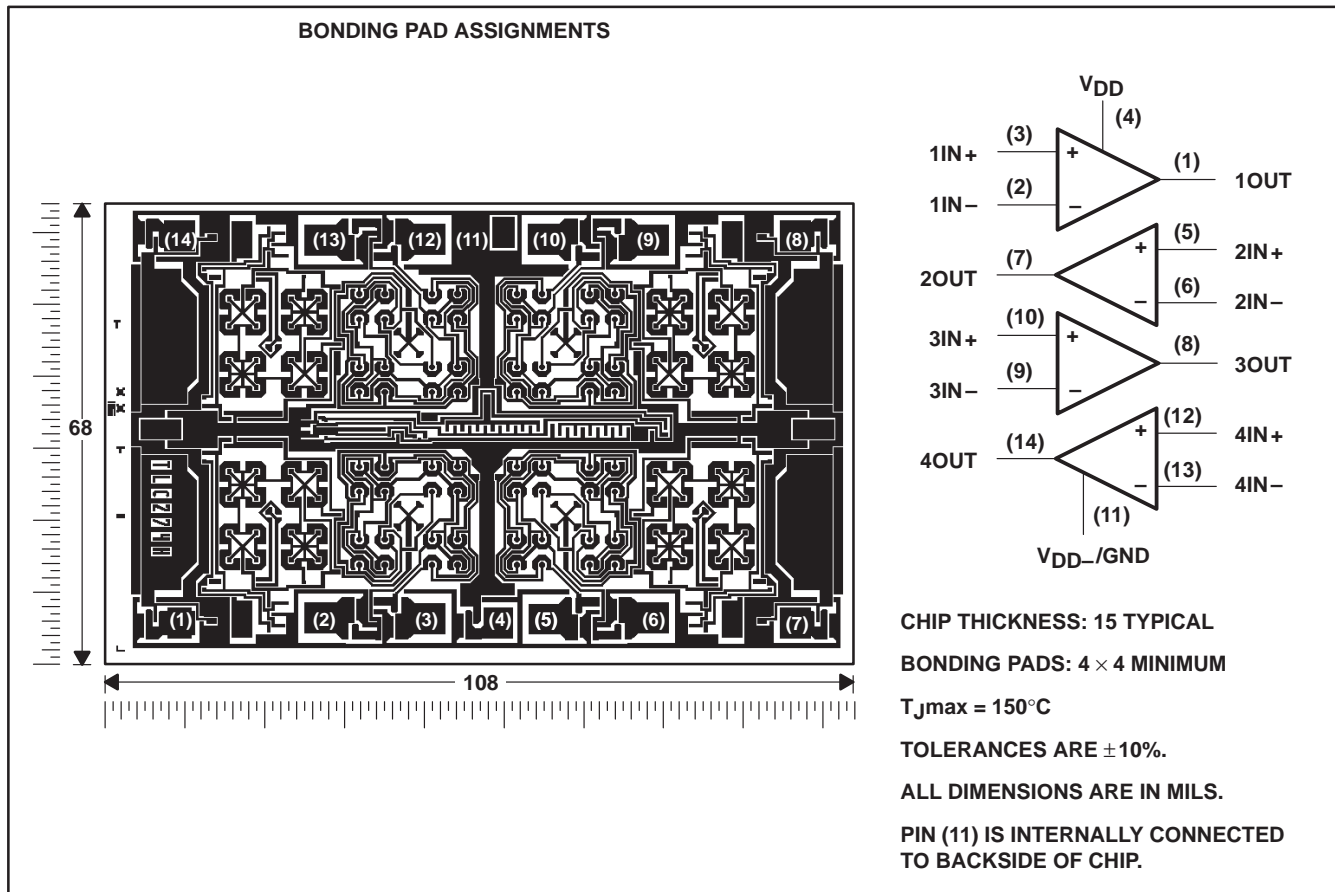

**TLC254, TLC254A, TLC254B, TLC254Y, TLC25L4, TLC25L4A, TLC25L4B
TLC25L4Y, TLC25M4, TLC25M4A, TLC25M4B, TLC25M4Y
LinCMOS™ QUAD OPERATIONAL AMPLIFIERS**

SLOS003F – JUNE 1983 – REVISED AUGUST 1994

absolute maximum ratings over operating free-air temperature range (unless otherwise noted)†

Supply voltage, V_{DD} (see Note 1)	18 V
Differential input voltage (see Note 2)	± 18 V
Input voltage range (any input)	-0.3 V to 18 V
Duration of short-circuit at (or below) 25°C free-air temperature (see Note 3)	unlimited
Continuous total dissipation	See Dissipation Rating Table
Operating free-air temperature range	0°C to 70°C
Storage temperature range	-65°C to 150°C
Lead temperature 1,6 mm (1/16 inch) from case for 10 seconds	260°C

† Stresses beyond those listed under “absolute maximum ratings” may cause permanent damage to the device. These are stress ratings only, and functional operation of the device at these or any other conditions beyond those indicated under “recommended operating conditions” is not implied. Exposure to absolute-maximum-rated conditions for extended periods may affect device reliability.

- NOTES: 1. All voltage values, except differential voltages, are with respect to V_{DD-}/GND .
 2. Differential voltages are at $IN+$, with respect to $IN-$.
 3. The output may be shorted to either supply. Temperature and/or supply voltages must be limited to ensure the maximum dissipation rating is not exceeded.

DISSIPATION RATING TABLE

PACKAGE	$T_A \leq 25^\circ\text{C}$ POWER RATING	DERATING FACTOR ABOVE $T_A = 25^\circ\text{C}$	$T_A = 70^\circ\text{C}$ POWER RATING
D	725 mW	5.8 mW/°C	464 mW
N	1050 mW	9.2 mW/°C	736 mW
PW	700 mW	5.6 mW/°C	448 mW

recommended operating conditions

		MIN	MAX	UNIT
Supply voltage, V_{DD}		1.4	16	V
Common-mode input voltage, V_{IC}	$V_{DD} = 1.4$ V	0	0.2	V
	$V_{DD} = 5$ V	-0.2	4	
	$V_{DD} = 10$ V	-0.2	9	
	$V_{DD} = 16$ V	-0.2	14	
Operating free-air temperature, T_A		0	70	°C



electrical characteristics at specified free-air temperature, $V_{DD} = 1.4\text{ V}$ (unless otherwise noted)

PARAMETER		TEST CONDITIONST	T _A	TLC254_C			TLC25L4_C			TLC25M4_C			UNIT
				MIN	TYP	MAX	MIN	TYP	MAX	MIN	TYP	MAX	
V _{IO}	Input offset voltage	TLC25_4C	V _O = 0.2 V, R _S = 50 Ω	25°C		10		10		10		mV	
				0°C to 70°C		12		12		12			
				TLC25_4AC	25°C		5		5		5		
					0°C to 70°C		6.5		6.5		6.5		
				TLC25_4BC	25°C		2		2		2		
					0°C to 70°C		3		3		3		
aV _{IO}	Average temperature coefficient of input offset voltage		25°C to 70°C		1		1		1		μV/°C		
I _{IO}	Input offset current	V _O = 0.2 V	25°C		1		1		1		pA		
			0°C to 70°C		300		300		300				
I _{IB}	Input bias current	V _O = 0.2 V	25°C		1		1		1		pA		
			0°C to 70°C		600		600		600				
V _{ICR}	Common-mode input voltage range		25°C	0 to 0.2		0 to 0.2		0 to 0.2			V		
V _{OM}	Peak output voltage swing‡	V _{ID} = 100 mV	25°C	450	700	450	700	450	700		mV		
A _{VD}	Large-signal differential voltage amplification	V _O = 100 to 300 mV, R _S = 50 Ω	25°C		10		20		20		V/mV		
CMRR	Common-mode rejection ratio	V _O = 0.2 V, V _{IC} = V _{ICR} min	25°C	60	77	60	77	60	77		dB		
I _{DD}	Supply current	V _O = 0.2 V, No load	25°C		600	750		50	68		400	500	μA

† All characteristics are measured under open-loop conditions with zero common-mode input voltage unless otherwise specified. Unless otherwise noted, an output load resistor is connected from the output to ground and has the following value: for low bias, R_L = 1 MΩ, for medium bias R_L = 100 kΩ, and for high bias R_L = 10 kΩ.

‡ The output swings to the potential of V_{DD-}/GND.

operating characteristics, $V_{DD} = 1.4\text{ V}$, T_A = 25°C

PARAMETER		TEST CONDITIONS	TLC254_C			TLC25L4_C			TLC25M4_C			UNIT
			MIN	TYP	MAX	MIN	TYP	MAX	MIN	TYP	MAX	
SR	Slew rate at unity gain	See Figure 1		0.1		0.001		0.01			V/μs	
B ₁	Unity-gain bandwidth	A _V = 40 dB, R _S = 50 Ω, C _L = 10 pF, See Figure 1		12		12		12			kHz	
	Overshoot factor	See Figure 1		30%		35%		35%				

**TLC254, TLC254A, TLC254B, TLC254Y, TLC25L4, TLC25L4A, TLC25L4B
TLC25L4Y, TLC25M4, TLC25M4A, TLC25M4B, TLC25M4Y
LinCMOS™ QUAD OPERATIONAL AMPLIFIERS**

SLOS003F – JUNE 1983 – REVISED AUGUST 1994

electrical characteristics at specified free-air temperature, $V_{DD} = 5\text{ V}$ (unless otherwise noted)

PARAMETER		TEST CONDITIONS	T_A †	TLC254, TLC254AC, TLC254BC			UNIT
				MIN	TYP	MAX	
V_{IO}	Input offset voltage	TLC254C $V_O = 1.4\text{ V}$, $R_S = 50\ \Omega$,	$V_{IC} = 0$, $R_L = 10\text{ k}\Omega$	25°C	1.1	10	mV
				Full range		12	
		TLC254AC $V_O = 1.4\text{ V}$, $R_S = 50\ \Omega$,	$V_{IC} = 0$, $R_L = 10\text{ k}\Omega$	25°C	0.9	5	
				Full range		6.5	
		TLC254BC $V_O = 1.4\text{ V}$, $R_S = 50\ \Omega$,	$V_{IC} = 0$, $R_L = 10\text{ k}\Omega$	25°C	0.34	2	
				Full range		3	
α_{VIO}	Average temperature coefficient of input offset voltage		25°C to 70°C	1.8		$\mu\text{V}/^\circ\text{C}$	
I_{IO}	Input offset current (see Note 4)	$V_O = 2.5\text{ V}$,	$V_{IC} = 2.5\text{ V}$	25°C	0.1		pA
				70°C	7	300	
I_{IB}	Input bias current (see Note 4)	$V_O = 2.5\text{ V}$,	$V_{IC} = 2.5\text{ V}$	25°C	0.6		pA
				70°C	40	600	
V_{ICR}	Common-mode input voltage range (see Note 5)			25°C	-0.2 to 4	-0.3 to 4.2	V
				Full range	-0.2 to 3.5		
V_{OH}	High-level output voltage	$V_{ID} = 100\text{ mV}$,	$R_L = 10\text{ k}\Omega$	0°C	3	3.8	V
				25°C	3.2	3.8	
				70°C	3	3.8	
V_{OL}	Low-level output voltage	$V_{ID} = -100\text{ mV}$,	$I_{OL} = 0$	0°C	0	50	mV
				25°C	0	50	
				70°C	0	50	
A_{VD}	Large-signal differential voltage amplification	$V_O = 0.25\text{ V to }2\text{ V}$,	$R_L = 10\text{ k}\Omega$	0°C	4	27	V/mV
				25°C	5	23	
				70°C	4	20	
CMRR	Common-mode rejection ratio	$V_{IC} = V_{ICRmin}$		0°C	60	84	dB
				25°C	65	80	
				70°C	60	85	
k_{SVR}	Supply-voltage rejection ratio ($\Delta V_{DD}/\Delta V_{IO}$)	$V_{DD} = 5\text{ V to }10\text{ V}$,	$V_O = 1.4\text{ V}$	0°C	60	94	dB
				25°C	65	95	
				70°C	60	96	
I_{DD}	Supply current (four amplifiers)	$V_O = 2.5\text{ V}$, No load	$V_{IC} = 2.5\text{ V}$,	0°C	3.1	7.2	mA
				25°C	2.7	6.4	
				70°C	2.3	5.2	

† Full range is 0°C to 70°C.

NOTES: 4. The typical values of input bias current and input offset current below 5 pA were determined mathematically.
5. This range also applies to each input individually.

**TLC254, TLC254A, TLC254B, TLC254Y, TLC25L4, TLC25L4A, TLC25L4B
TLC25L4Y, TLC25M4, TLC25M4A, TLC25M4B, TLC25M4Y
LinCMOS™ QUAD OPERATIONAL AMPLIFIERS**

SLOS003F – JUNE 1983 – REVISED AUGUST 1994

electrical characteristics at specified free-air temperature, $V_{DD} = 10\text{ V}$ (unless otherwise noted)

PARAMETER		TEST CONDITIONS		T_A †	TLC254C, TLC254AC, TLC254BC			UNIT
					MIN	TYP	MAX	
V_{IO}	Input offset voltage	TLC254C	$V_O = 1.4\text{ V},$ $R_S = 50\ \Omega,$	$V_{IC} = 0,$ $R_L = 10\text{ k}\Omega$	25°C	1.1	10	mV
					Full range		12	
		TLC254AC	$V_O = 1.4\text{ V},$ $R_S = 50\ \Omega,$	$V_{IC} = 0,$ $R_L = 10\text{ k}\Omega$	25°C	0.9	5	
					Full range		6.5	
		TLC254BC	$V_O = 1.4\text{ V},$ $R_S = 50\ \Omega,$	$V_{IC} = 0,$ $R_L = 10\text{ k}\Omega$	25°C	0.39	2	
					Full range		3	
∞V_{IO}	Average temperature coefficient of input offset voltage			25°C to 70°C		2	$\mu\text{V}/^\circ\text{C}$	
I_{IO}	Input offset current (see Note 4)	$V_O = 5\text{ V},$	$V_{IC} = 5\text{ V}$	25°C	0.1		pA	
				70°C	7	300		
I_{IB}	Input bias current (see Note 4)	$V_O = 5\text{ V},$	$V_{IC} = 5\text{ V}$	25°C	0.7		pA	
				70°C	50	600		
V_{ICR}	Common-mode input voltage range (see Note 5)			25°C	-0.2 to 9	-0.3 to 9.2	V	
				Full range	-0.2 to 8.5			
V_{OH}	High-level output voltage	$V_{ID} = 100\text{ mV},$	$R_L = 10\text{ k}\Omega$	0°C	7.8	8.5	V	
				25°C	8	8.5		
				70°C	7.8	8.4		
V_{OL}	Low-level output voltage	$V_{ID} = -100\text{ mV},$	$I_{OL} = 0$	0°C	0	50	mV	
				25°C	0	50		
				70°C	0	50		
A_{VD}	Large-signal differential voltage amplification	$V_O = 1\text{ V to }6\text{ V},$	$R_L = 10\text{ k}\Omega$	0°C	7.5	42	V/mV	
				25°C	10	36		
				70°C	7.5	32		
$CMRR$	Common-mode rejection ratio	$V_{IC} = V_{ICRmin}$		0°C	60	88	dB	
				25°C	65	85		
				70°C	60	88		
k_{SVR}	Supply-voltage rejection ratio ($\Delta V_{DD}/\Delta V_{IO}$)	$V_{DD} = 5\text{ V to }10\text{ V},$	$V_O = 1.4\text{ V}$	0°C	60	94	dB	
				25°C	65	95		
				70°C	60	96		
I_{DD}	Supply current (four amplifiers)	$V_O = 5\text{ V},$ No load	$V_{IC} = 5\text{ V},$	0°C	4.5	8.8	mA	
				25°C	3.8	8		
				70°C	3.2	6.8		

† Full range is 0°C to 70°C.

NOTES: 4. The typical values of input bias current and input offset current below 5 pA were determined mathematically.

5. This range also applies to each input individually.



TLC254, TLC254A, TLC254B, TLC254Y, TLC25L4, TLC25L4A, TLC25L4B
 TLC25L4Y, TLC25M4, TLC25M4A, TLC25M4B, TLC25M4Y
 LinCMOS™ QUAD OPERATIONAL AMPLIFIERS

SLOS003F – JUNE 1983 – REVISED AUGUST 1994

operating characteristics, $V_{DD} = 5\text{ V}$

PARAMETER	TEST CONDITIONS	T_A	TLC254C, TLC254AC, TLC254BC			UNIT
			MIN	TYP	MAX	
SR Slew rate at unity gain	$R_L = 10\text{ k}\Omega$, See Figure 1 $C_L = 20\text{ pF}$	$V_{I(PP)} = 1\text{ V}$	0°C	4		V/ μ s
			25°C	3.6		
		$V_{I(PP)} = 1\text{ V}$	70°C	3		
			$V_{I(PP)} = 2.5\text{ V}$	0°C	3.1	
		25°C		2.9		
		70°C		2.5		
V_n Equivalent input noise voltage	$f = 1\text{ kHz}$, $R_S = 20\ \Omega$, See Figure 2	25°C	25		nV/ $\sqrt{\text{Hz}}$	
B_{OM} Maximum output-swing bandwidth	$V_O = V_{OH}$, See Figure 1 $C_L = 20\text{ pF}$, $R_L = 10\text{ k}\Omega$	0°C	340		kHz	
		25°C	320			
		70°C	260			
B_1 Unity-gain bandwidth	$V_I = 10\text{ mV}$, $C_L = 20\text{ pF}$, See Figure 1	0°C	2		MHz	
		25°C	1.7			
		70°C	1.3			
ϕ_m Phase margin	$V_I = 10\text{ mV}$, See Figure 3 $f = B_1$, $C_L = 20\text{ pF}$	0°C	47°			
		25°C	46°			
		70°C	43°			

operating characteristics, $V_{DD} = 10\text{ V}$

PARAMETER	TEST CONDITIONS	T_A	TLC254C, TLC254AC, TLC254BC			UNIT
			MIN	TYP	MAX	
SR Slew rate at unity gain	$R_L = 10\text{ k}\Omega$, See Figure 1 $C_L = 20\text{ pF}$	$V_{I(PP)} = 1\text{ V}$	0°C	5.9		V/ μ s
			25°C	5.3		
			70°C	4.3		
		$V_{I(PP)} = 5.5\text{ V}$	0°C	5.1		
			25°C	4.6		
			70°C	3.8		
V_n Equivalent input noise voltage	$f = 1\text{ kHz}$, $R_S = 20\ \Omega$, See Figure 2	25°C	25		nV/ $\sqrt{\text{Hz}}$	
B_{OM} Maximum output-swing bandwidth	$V_O = V_{OH}$, See Figure 1 $C_L = 20\text{ pF}$, $R_L = 10\text{ k}\Omega$	0°C	220		kHz	
		25°C	200			
		70°C	140			
B_1 Unity-gain bandwidth	$V_I = 10\text{ mV}$, $C_L = 20\text{ pF}$, See Figure 1	0°C	2.5		MHz	
		25°C	2.2			
		70°C	1.8			
ϕ_m Phase margin	$V_I = 10\text{ mV}$, See Figure 3 $f = B_1$, $C_L = 20\text{ pF}$	0°C	50°			
		25°C	49°			
		70°C	46°			



TLC254, TLC254A, TLC254B, TLC254Y, TLC25L4, TLC25L4A, TLC25L4B
 TLC25L4Y, TLC25M4, TLC25M4A, TLC25M4B, TLC25M4Y
 LinCMOS™ QUAD OPERATIONAL AMPLIFIERS

SLOS003F – JUNE 1983 – REVISED AUGUST 1994

electrical characteristics at specified free-air temperature, $V_{DD} = 5\text{ V}$ (unless otherwise noted)

PARAMETER		TEST CONDITIONS	T_A †	TLC25L4C TLC25L4AC TLC25L4BC			UNIT
				MIN	TYP	MAX	
V_{IO}	Input offset voltage	TLC25L4C $V_O = 1.4\text{ V}$, $R_S = 50\ \Omega$, $V_{IC} = 0$, $R_L = 1\text{ M}\Omega$	25°C	1.1	10	mV	
			Full range		12		
		TLC25L4AC $V_O = 1.4\text{ V}$, $R_S = 50\ \Omega$, $V_{IC} = 0$, $R_L = 1\text{ M}\Omega$	25°C	0.9	5		
			Full range		6.5		
		TLC25L4BC $V_O = 1.4\text{ V}$, $R_S = 50\ \Omega$, $V_{IC} = 0$, $R_L = 1\text{ M}\Omega$	25°C	0.24	2		
			Full range		3		
$^{\circ}V_{IO}$	Average temperature coefficient of input offset voltage		25°C to 70°C	1.1		$\mu\text{V}/^{\circ}\text{C}$	
I_{IO}	Input offset current (see Note 4)	$V_O = 2.5\text{ V}$, $V_{IC} = 2.5\text{ V}$	25°C	0.1		pA	
			70°C	7	300		
I_{IB}	Input bias current (see Note 4)	$V_O = 2.5\text{ V}$, $V_{IC} = 2.5\text{ V}$	25°C	0.6		pA	
			70°C	40	600		
V_{ICR}	Common-mode input voltage range (see Note 5)		25°C	-0.2 to 4	-0.3 to 4.2	V	
			Full range	-0.2 to 3.5			
V_{OH}	High-level output voltage	$V_{ID} = 100\text{ mV}$, $R_L = 1\text{ M}\Omega$	0°C	3	4.1	V	
			25°C	3.2	4.1		
			70°C	3	4.2		
V_{OL}	Low-level output voltage	$V_{ID} = -100\text{ mV}$, $I_{OL} = 0$	0°C	0	50	mV	
			25°C	0	50		
			70°C	0	50		
A_{VD}	Large-signal differential voltage amplification	$V_O = 0.25\text{ V to }2\text{ V}$, $R_L = 1\text{ M}\Omega$	0°C	50	680	V/mV	
			25°C	50	520		
			70°C	50	380		
CMRR	Common-mode rejection ratio	$V_{IC} = V_{ICRmin}$	0°C	60	95	dB	
			25°C	65	94		
			70°C	60	95		
k_{SVR}	Supply-voltage rejection ratio ($\Delta V_{DD}/\Delta V_{IO}$)	$V_{DD} = 5\text{ V to }10\text{ V}$, $V_O = 1.4\text{ V}$	0°C	60	97	dB	
			25°C	70	98		
			70°C	60	97		
I_{DD}	Supply current (four amplifiers)	$V_O = 2.5\text{ V}$, No load $V_{IC} = 2.5\text{ V}$	0°C	48	84	μA	
			25°C	40	68		
			70°C	31	56		

† Full range is 0°C to 70°C.

NOTES: 4. The typical values of input bias current and input offset current below 5 pA were determined mathematically.

5. This range also applies to each input individually.



**TLC254, TLC254A, TLC254B, TLC254Y, TLC25L4, TLC25L4A, TLC25L4B
TLC25L4Y, TLC25M4, TLC25M4A, TLC25M4B, TLC25M4Y
LinCMOS™ QUAD OPERATIONAL AMPLIFIERS**

SLOS003F – JUNE 1983 – REVISED AUGUST 1994

electrical characteristics at specified free-air temperature, $V_{DD} = 10\text{ V}$ (unless otherwise noted)

PARAMETER		TEST CONDITIONS		T_A^\dagger	TLC25L4C TLC25L4AC TLC25L4BC			UNIT
					MIN	TYP	MAX	
V_{IO}	Input offset voltage	TLC25L4C	$V_O = 1.4\text{ V},$ $R_S = 50\ \Omega,$	$V_{IC} = 0,$ $R_L = 1\text{ M}\Omega$	25°C	1.1	10	mV
					Full range		12	
		TLC25L4AC	$V_O = 1.4\text{ V},$ $R_S = 50\ \Omega,$	$V_{IC} = 0,$ $R_L = 1\text{ M}\Omega$	25°C	0.9	5	
					Full range		6.5	
		TLC25L4BC	$V_O = 1.4\text{ V},$ $R_S = 50\ \Omega,$	$V_{IC} = 0,$ $R_L = 1\text{ M}\Omega$	25°C	0.26	2	
					Full range		3	
α_{VIO}	Average temperature coefficient of input offset voltage			25°C to 70°C	1		$\mu\text{V}/^\circ\text{C}$	
I_{IO}	Input offset current (see Note 4)	$V_O = 5\text{ V},$	$V_{IC} = 5\text{ V}$	25°C	0.1		pA	
				70°C	7	300		
I_{IB}	Input bias current (see Note 4)	$V_O = 5\text{ V},$	$V_{IC} = 5\text{ V}$	25°C	0.7		pA	
				70°C	50	600		
V_{ICR}	Common-mode input voltage range (see Note 5)			25°C	-0.2 to 9	-0.3 to 9.2	V	
				Full range	-0.2 to 8.5		V	
V_{OH}	High-level output voltage	$V_{ID} = 100\text{ mV},$	$R_L = 1\text{ M}\Omega$	0°C	7.8	8.9	V	
				25°C	8	8.9		
				70°C	7.8	8.9		
V_{OL}	Low-level output voltage	$V_{ID} = -100\text{ mV},$	$I_{OL} = 0$	0°C	0	50	mV	
				25°C	0	50		
				70°C	0	50		
A_{VD}	Large-signal differential voltage amplification	$V_O = 1\text{ V to }6\text{ V},$	$R_L = 1\text{ M}\Omega$	0°C	50	1025	V/mV	
				25°C	50	870		
				70°C	50	660		
CMRR	Common-mode rejection ratio	$V_{IC} = V_{ICRmin}$		0°C	60	97	dB	
				25°C	65	97		
				70°C	60	97		
k_{SVR}	Supply-voltage rejection ratio ($\Delta V_{DD}/\Delta V_{IO}$)	$V_{DD} = 5\text{ V to }10\text{ V},$	$V_O = 1.4\text{ V}$	0°C	60	97	dB	
				25°C	70	97		
				70°C	60	98		
I_{DD}	Supply current (four amplifiers)	$V_O = 5\text{ V},$ No load	$V_{IC} = 5\text{ V},$	0°C	72	132	μA	
				25°C	57	92		
				70°C	44	80		

† Full range is 0°C to 70°C.

NOTES: 4. The typical values of input bias current and input offset current below 5 pA were determined mathematically.

5. This range also applies to each input individually.



**TLC254, TLC254A, TLC254B, TLC254Y, TLC25L4, TLC25L4A, TLC25L4B
TLC25L4Y, TLC25M4, TLC25M4A, TLC25M4B, TLC25M4Y
LinCMOS™ QUAD OPERATIONAL AMPLIFIERS**

SLOS003F – JUNE 1983 – REVISED AUGUST 1994

operating characteristics, $V_{DD} = 5\text{ V}$

PARAMETER	TEST CONDITIONS	T_A	TLC25L4C TLC25L4AC TLC25L4BC			UNIT
			MIN	TYP	MAX	
SR Slew rate at unity gain	$R_L = 1\text{ M}\Omega$, See Figure 1 $C_L = 20\text{ pF}$	$V_{I(PP)} = 1\text{ V}$	0°C	0.04		V/ μ s
			25°C	0.03		
			70°C	0.03		
		$V_{I(PP)} = 2.5\text{ V}$	0°C	0.03		
			25°C	0.03		
			70°C	0.02		
V_n Equivalent input noise voltage	$f = 1\text{ kHz}$, $R_S = 20\ \Omega$, See Figure 2	25°C	70		nV/ $\sqrt{\text{Hz}}$	
B_{OM} Maximum output-swing bandwidth	$V_O = V_{OH}$, See Figure 1 $C_L = 20\text{ pF}$, $R_L = 1\text{ M}\Omega$	0°C	6		kHz	
		25°C	5			
		70°C	4.5			
B_1 Unity-gain bandwidth	$V_I = 10\text{ mV}$, $C_L = 20\text{ pF}$, See Figure 1	0°C	100		kHz	
		25°C	85			
		70°C	65			
ϕ_m Phase margin	$V_I = 10\text{ mV}$, See Figure 3 $f = B_1$, $C_L = 20\text{ pF}$	0°C	36°			
		25°C	34°			
		70°C	30°			

operating characteristics, $V_{DD} = 10\text{ V}$

PARAMETER	TEST CONDITIONS	T_A	TLC25L4C TLC25L4AC TLC25L4BC			UNIT
			MIN	TYP	MAX	
SR Slew rate at unity gain	$R_L = 1\text{ M}\Omega$, See Figure 1 $C_L = 20\text{ pF}$	$V_{I(PP)} = 1\text{ V}$	0°C	0.05		V/ μ s
			25°C	0.05		
			70°C	0.04		
		$V_{I(PP)} = 5.5\text{ V}$	0°C	0.05		
			25°C	0.04		
			70°C	0.04		
V_n Equivalent input noise voltage	$f = 1\text{ kHz}$, $R_S = 20\ \Omega$, See Figure 2	25°C	70		nV/ $\sqrt{\text{Hz}}$	
B_{OM} Maximum output-swing bandwidth	$V_O = V_{OH}$, See Figure 1 $C_L = 20\text{ pF}$, $R_L = 1\text{ M}\Omega$	0°C	1.3		kHz	
		25°C	1			
		70°C	0.9			
B_1 Unity-gain bandwidth	$V_I = 10\text{ mV}$, $C_L = 20\text{ pF}$, See Figure 1	0°C	125		kHz	
		25°C	110			
		70°C	90			
ϕ_m Phase margin	$V_I = 10\text{ mV}$, See Figure 3 $f = B_1$, $C_L = 20\text{ pF}$	0°C	40°			
		25°C	38°			
		70°C	34°			



**TLC254, TLC254A, TLC254B, TLC254Y, TLC25L4, TLC25L4A, TLC25L4B
TLC25L4Y, TLC25M4, TLC25M4A, TLC25M4B, TLC25M4Y
LinCMOS™ QUAD OPERATIONAL AMPLIFIERS**

SLOS003F – JUNE 1983 – REVISED AUGUST 1994

electrical characteristics at specified free-air temperature, $V_{DD} = 5\text{ V}$ (unless otherwise noted)

PARAMETER		TEST CONDITIONS		T_A †	TLC25M4C TLC25M4AC TLC25M4BC			UNIT
					MIN	TYP	MAX	
V_{IO}	Input offset voltage	TLC25M4C	$V_O = 1.4\text{ V}$, $R_S = 50\ \Omega$	$V_{IC} = 0$, $R_L = 100\text{ k}\Omega$	25°C	1.1	10	mV
					Full range		12	
		TLC25M4AC	$V_O = 1.4\text{ V}$, $R_S = 50\ \Omega$	$V_{IC} = 0$, $R_L = 100\text{ k}\Omega$	25°C	0.9	5	
					Full range		6.5	
		TLC25M4BC	$V_O = 1.4\text{ V}$, $R_S = 50\ \Omega$	$V_{IC} = 0$, $R_L = 100\text{ k}\Omega$	25°C	0.25	2	
					Full range		3	
∞V_{IO}	Average temperature coefficient of input offset voltage			25°C to 70°C	1.7		$\mu\text{V}/^\circ\text{C}$	
I_{IO}	Input offset current (see Note 4)	$V_O = 2.5\text{ V}$	$V_{IC} = 2.5\text{ V}$	25°C	0.1		pA	
				70°C	7	300		
I_{IB}	Input bias current (see Note 4)	$V_O = 2.5\text{ V}$	$V_{IC} = 2.5\text{ V}$	25°C	0.6		pA	
				70°C	40	600		
V_{ICR}	Common-mode input voltage range (see Note 5)			25°C	-0.2 to 4	-0.3 to 4.2	V	
				Full range	-0.2 to 3.5		V	
V_{OH}	High-level output voltage	$V_{ID} = 100\text{ mV}$	$R_L = 100\text{ k}\Omega$	0°C	3	3.9	V	
				25°C	3.2	3.9		
				70°C	3	4		
V_{OL}	Low-level output voltage	$V_{ID} = -100\text{ mV}$	$I_{OL} = 0$	0°C		0 50	mV	
				25°C		0 50		
				70°C		0 50		
A_{VD}	Large-signal differential voltage amplification	$V_O = 0.25\text{ V to }2\text{ V}$	$R_L = 100\text{ k}\Omega$	0°C	15	200	V/mV	
				25°C	25	170		
				70°C	15	140		
CMRR	Common-mode rejection ratio	$V_{IC} = V_{ICRmin}$		0°C	60	91	dB	
				25°C	65	91		
				70°C	60	92		
k_{SVR}	Supply-voltage rejection ratio ($\Delta V_{DD}/\Delta V_{IO}$)	$V_{DD} = 5\text{ V to }10\text{ V}$	$V_O = 1.4\text{ V}$	0°C	60	92	dB	
				25°C	70	93		
				70°C	60	94		
I_{DD}	Supply current (four amplifiers)	$V_O = 2.5\text{ V}$, No load	$V_{IC} = 2.5\text{ V}$	0°C	500	1280	μA	
				25°C	420	1120		
				70°C	340	880		

† Full range is 0°C to 70°C.

NOTES: 4. The typical values of input bias current and input offset current below 5 pA were determined mathematically.

5. This range also applies to each input individually.



TLC254, TLC254A, TLC254B, TLC254Y, TLC25L4, TLC25L4A, TLC25L4B
 TLC25L4Y, TLC25M4, TLC25M4A, TLC25M4B, TLC25M4Y
 LinCMOS™ QUAD OPERATIONAL AMPLIFIERS

SLOS003F – JUNE 1983 – REVISED AUGUST 1994

electrical characteristics at specified free-air temperature, $V_{DD} = 10\text{ V}$ (unless otherwise noted)

PARAMETER		TEST CONDITIONS		T_A †	TLC25M4C TLC25M4AC TLC25M4BC			UNIT
					MIN	TYP	MAX	
V_{IO}	Input offset voltage	TLC25M4C	$V_O = 1.4\text{ V}$, $R_S = 50\ \Omega$	$V_{IC} = 0$, $R_L = 100\text{ k}\Omega$	25°C	1.1	10	mV
					Full range		12	
		TLC25M4AC	$V_O = 1.4\text{ V}$, $R_S = 50\ \Omega$	$V_{IC} = 0$, $R_L = 100\text{ k}\Omega$	25°C	0.9	5	
					Full range		6.5	
		TLC25M4BC	$V_O = 1.4\text{ V}$, $R_S = 50\ \Omega$	$V_{IC} = 0$, $R_L = 100\text{ k}\Omega$	25°C	0.26	2	
					Full range		3	
α_{VIO}	Average temperature coefficient of input offset voltage			25°C to 70°C	2.1		$\mu\text{V}/^\circ\text{C}$	
I_{IO}	Input offset current (see Note 4)	$V_O = 5\text{ V}$	$V_{IC} = 5\text{ V}$	25°C	0.1		pA	
				70°C	7	300		
I_{IB}	Input bias current (see Note 4)	$V_O = 5\text{ V}$	$V_{IC} = 5\text{ V}$	25°C	0.7		pA	
				70°C	50	600		
V_{ICR}	Common-mode input voltage range (see Note 5)			25°C	-0.2 to 9	-0.3 to 9.2	V	
				Full range	-0.2 to 8.5		V	
V_{OH}	High-level output voltage	$V_{ID} = 100\text{ mV}$	$R_L = 100\text{ k}\Omega$	0°C	7.8	8.7	V	
				25°C	8	8.7		
				70°C	7.8	8.7		
V_{OL}	Low-level output voltage	$V_{ID} = -100\text{ mV}$	$I_{OL} = 0$	0°C	0	50	mV	
				25°C	0	50		
				70°C	0	50		
A_{VD}	Large-signal differential voltage amplification	$V_O = 1\text{ V to }6\text{ V}$	$R_L = 100\text{ k}\Omega$	0°C	15	320	V/mV	
				25°C	25	275		
				70°C	15	230		
CMRR	Common-mode rejection ratio	$V_{IC} = V_{ICRmin}$		0°C	60	94	dB	
				25°C	65	94		
				70°C	60	94		
k_{SVR}	Supply-voltage rejection ratio ($\Delta V_{DD}/\Delta V_{IO}$)	$V_{DD} = 5\text{ V to }10\text{ V}$	$V_O = 1.4\text{ V}$	0°C	60	92	dB	
				25°C	70	93		
				70°C	60	94		
I_{DD}	Supply current (four amplifiers)	$V_O = 5\text{ V}$, No load	$V_{IC} = 5\text{ V}$	0°C	690	1600	μA	
				25°C	570	1200		
				70°C	440	1120		

† Full range is 0°C to 70°C.

NOTES: 4. The typical values of input bias current and input offset current below 5 pA were determined mathematically.

5. This range also applies to each input individually.



TLC254, TLC254A, TLC254B, TLC254Y, TLC25L4, TLC25L4A, TLC25L4B
TLC25L4Y, TLC25M4, TLC25M4A, TLC25M4B, TLC25M4Y
LinCMOS™ QUAD OPERATIONAL AMPLIFIERS

SLOS003F – JUNE 1983 – REVISED AUGUST 1994

operating characteristics, $V_{DD} = 5\text{ V}$

PARAMETER	TEST CONDITIONS	T_A	TLC25M4C TLC25M4AC TLC25M4BC			UNIT
			MIN	TYP	MAX	
SR Slew rate at unity gain	$R_L = 100\text{ k}\Omega$, See Figure 1 $C_L = 20\text{ pF}$	$V_{I(PP)} = 1\text{ V}$	0°C	0.46		V/ μs
			25°C	0.43		V/ μs
			70°C	0.36		
		$V_{I(PP)} = 2.5\text{ V}$	0°C	0.43		V/ μs
			25°C	0.40		
			70°C	0.34		
V_n Equivalent input noise voltage	$f = 1\text{ kHz}$, $R_S = 20\ \Omega$, See Figure 2	25°C		32		nV/ $\sqrt{\text{Hz}}$
B_{OM} Maximum output-swing bandwidth	$V_O = V_{OH}$, See Figure 1 $C_L = 20\text{ pF}$, $R_L = 100\text{ k}\Omega$	0°C		60		kHz
		25°C		55		
		70°C		50		
B_1 Unity-gain bandwidth	$V_I = 10\text{ mV}$, $C_L = 20\text{ pF}$, See Figure 1	0°C		610		kHz
		25°C		525		
		70°C		400		
ϕ_m Phase margin	$V_I = 10\text{ mV}$, See Figure 3 $f = B_1$, $C_L = 20\text{ pF}$	0°C		41°		
		25°C		40°		
		70°C		39°		

operating characteristics, $V_{DD} = 10\text{ V}$

PARAMETER	TEST CONDITIONS	T_A	TLC25M4C TLC25M4AC TLC25M4BC			UNIT
			MIN	TYP	MAX	
SR Slew rate at unity gain	$R_L = 100\text{ k}\Omega$, See Figure 1 $C_L = 20\text{ pF}$	$V_{I(PP)} = 1\text{ V}$	0°C	0.67		V/ μs
			25°C	0.62		
			70°C	0.51		
		$V_{I(PP)} = 5.5\text{ V}$	0°C	0.61		
			25°C	0.56		
			70°C	0.46		
V_n Equivalent input noise voltage	$f = 1\text{ kHz}$, $R_S = 20\ \Omega$, See Figure 2	25°C		32		nV/ $\sqrt{\text{Hz}}$
B_{OM} Maximum output-swing bandwidth	$V_O = V_{OH}$, See Figure 1 $C_L = 20\text{ pF}$, $R_L = 100\text{ k}\Omega$	0°C		40		kHz
		25°C		35		
		70°C		30		
B_1 Unity-gain bandwidth	$V_I = 10\text{ mV}$, $C_L = 20\text{ pF}$, See Figure 1	0°C		710		kHz
		25°C		635		
		70°C		510		
ϕ_m Phase margin	$V_I = 10\text{ mV}$, See Figure 3 $f = B_1$, $C_L = 20\text{ pF}$	0°C		44°		
		25°C		43°		
		70°C		42°		



**TLC254, TLC254A, TLC254B, TLC254Y, TLC25L4, TLC25L4A, TLC25L4B
TLC25L4Y, TLC25M4, TLC25M4A, TLC25M4B, TLC25M4Y
LinCMOS™ QUAD OPERATIONAL AMPLIFIERS**

SLOS003F – JUNE 1983 – REVISED AUGUST 1994

electrical characteristics, $V_{DD} = 5\text{ V}$, $T_A = 25^\circ\text{C}$ (unless otherwise noted)

PARAMETER	TEST CONDITIONS	TLC254Y			TLC25L4Y			TLC25M4Y			UNIT
		MIN	TYP	MAX	MIN	TYP	MAX	MIN	TYP	MAX	
V_{IO} Input offset voltage	$V_O = 1.4\text{ V}$, $V_{IC} = 0\text{ V}$, $R_S = 50\ \Omega$, See Note 6		1.1	10		1.1	10		1.1	10	mV
α_{VIO} Average temperature coefficient of input offset voltage			1.8			1.1			1.7		$\mu\text{V}/^\circ\text{C}$
I_{IO} Input offset current (see Note 4)	$V_O = V_{DD}/2$, $V_{IC} = V_{DD}/2$		0.1			0.1			0.1		pA
I_{IB} Input bias current (see Note 4)	$V_O = V_{DD}/2$, $V_{IC} = V_{DD}/2$		0.6			0.6			0.6		pA
V_{ICR} Common-mode input voltage range (see Note 5)		-0.2 to 4	-0.3 to 4.2		-0.2 to 4	-0.3 to 4.2		-0.2 to 4	-0.3 to 4.2		V
V_{OH} High-level output voltage	$V_{ID} = 100\text{ mV}$, $R_L = 100\text{ k}\Omega$	3.2	3.8		3.2	4.1		3.2	3.9		V
V_{OL} Low-level output voltage	$V_{ID} = -100\text{ mV}$, $I_{OL} = 0$		0	50		0	50		0	50	mV
A_{VD} Large-signal differential voltage amplification	$V_O = 0.25\text{ V}$, See Note 6	5	23		50	520		25	170		V/mV
CMRR Common-mode rejection ratio	$V_{IC} = V_{ICRmin}$	65	80		65	94		65	91		dB
k_{SVR} Supply-voltage rejection ratio ($\Delta V_{DD}/\Delta V_{IO}$)	$V_{DD} = 5\text{ V to }10\text{ V}$, $V_O = 1.4\text{ V}$	65	95		70	97		70	93		dB
I_{DD} Supply current	$V_O = V_{DD}/2$, $V_{IC} = V_{DD}/2$, No load		2.7	6.4		0.04	0.068		0.42	1.12	mA

NOTES: 4. The typical values of input bias current and input offset current below 5 pA were determined mathematically.
5. This range also applies to each input individually.
6. For low-bias mode, $R_L = 1\text{ M}\Omega$, for medium-bias mode, $R_L = 100\text{ k}\Omega$, and for high-bias mode, $R_L = 10\text{ k}\Omega$.

operating characteristics, $V_{DD} = 5\text{ V}$, $T_A = 25^\circ\text{C}$

PARAMETER	TEST CONDITIONS	TLC254Y			TLC25L4Y			TLC25M4Y			UNIT
		MIN	TYP	MAX	MIN	TYP	MAX	MIN	TYP	MAX	
SR Slew rate at unity gain	$C_L = 20\text{ pF}$, See Note 6	$V_{I(PP)} = 1\text{ V}$	3.6		0.03		0.43				V/ μs
		$V_{I(PP)} = 2.5\text{ V}$	2.9		0.03		0.40				
V_n Equivalent input noise voltage	$f = 1\text{ kHz}$, $R_S = 20\ \Omega$		2.5			70			32		$\text{nV}/\sqrt{\text{Hz}}$
B_{OM} Maximum output-swing bandwidth	$V_O = V_{OH}$, $R_L = 10\text{ k}\Omega$		320			5			55		kHz
B_1 Unity-gain bandwidth	$V_I = 10\text{ mV}$, $C_L = 20\text{ pF}$		1.7			0.085			0.525		MHz
ϕ_m Phase margin	$f = B_1$, $C_L = 20\text{ pF}$		46°			34°			40°		

NOTE 6: For low-bias mode, $R_L = 1\text{ M}\Omega$, for medium-bias mode, $R_L = 100\text{ k}\Omega$, and for high-bias mode, $R_L = 10\text{ k}\Omega$.



PARAMETER MEASUREMENT INFORMATION

single-supply versus split-supply test circuits

Because the TLC25_4, TLC25_4A, and TLC25_4B are optimized for single-supply operation, circuit configurations used for the various tests often present some inconvenience since the input signal, in many cases, must be offset from ground. This inconvenience can be avoided by testing the device with split supplies and the output load tied to the negative rail. A comparison of single-supply versus split-supply test circuits is shown below. The use of either circuit gives the same result.

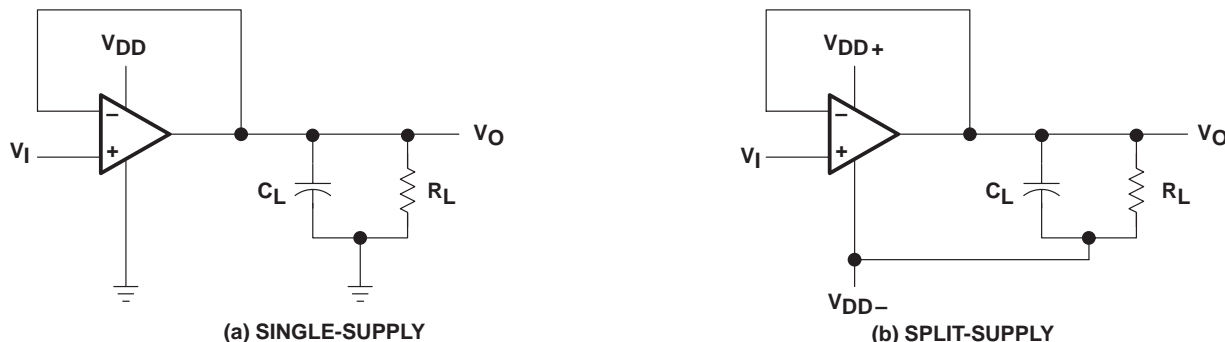

Figure 1. Unity-Gain Amplifier

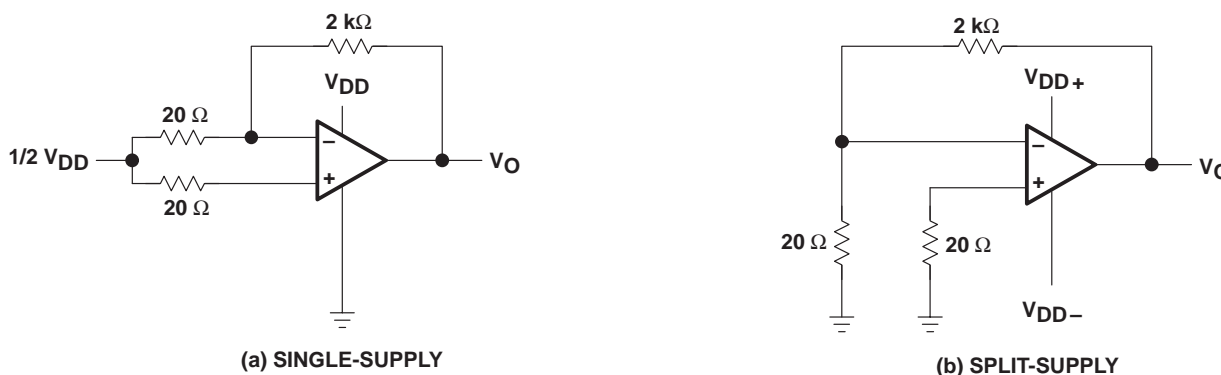

Figure 2. Noise-Test Circuit

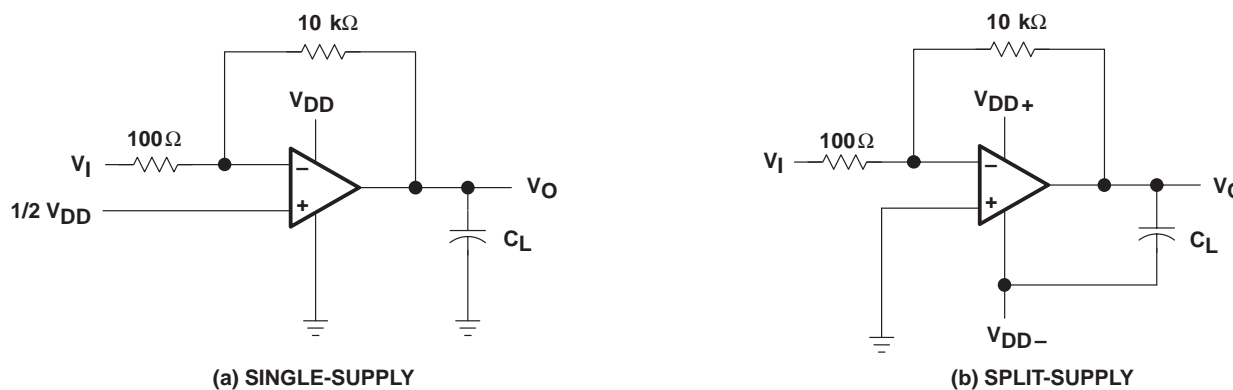

Figure 3. Gain-of-100 Inverting Amplifier

TYPICAL CHARACTERISTICS

Table of Graphs

			FIGURE
I _{DD}	Supply current	vs Supply voltage	4
		vs Free-air temperature	5
A _{VD}	Large-signal differential voltage amplification	Low bias vs Frequency	6
		Medium bias vs Frequency	7
		High bias vs Frequency	8
	Phase shift	Low bias vs Frequency	6
		Medium bias vs Frequency	7
		High bias vs Frequency	8

**SUPPLY CURRENT
vs
SUPPLY VOLTAGE**

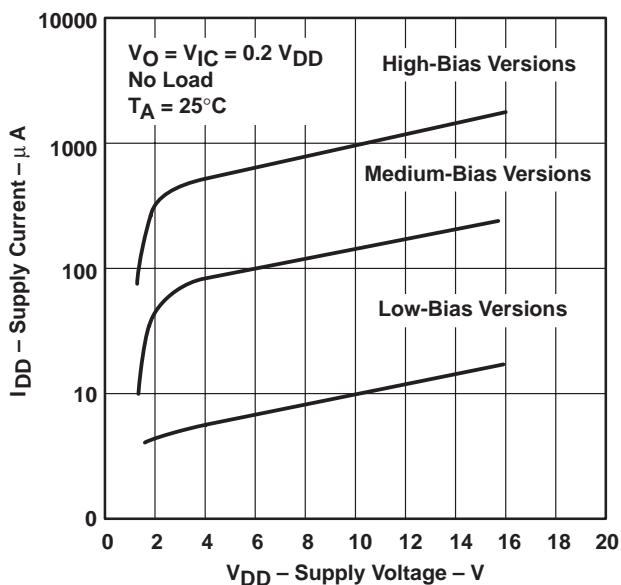

Figure 4

**SUPPLY CURRENT
vs
FREE-AIR TEMPERATURE**

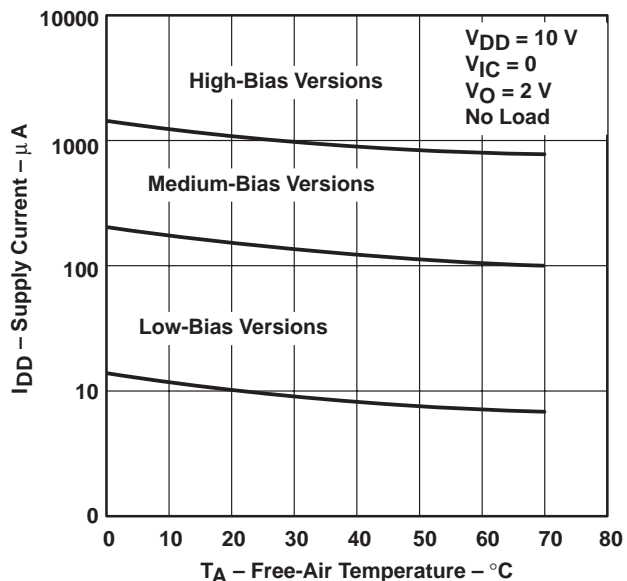

Figure 5

TYPICAL CHARACTERISTICS

LOW-BIAS LARGE-SIGNAL DIFFERENTIAL
 VOLTAGE AMPLIFICATION AND PHASE SHIFT

vs
 FREQUENCY

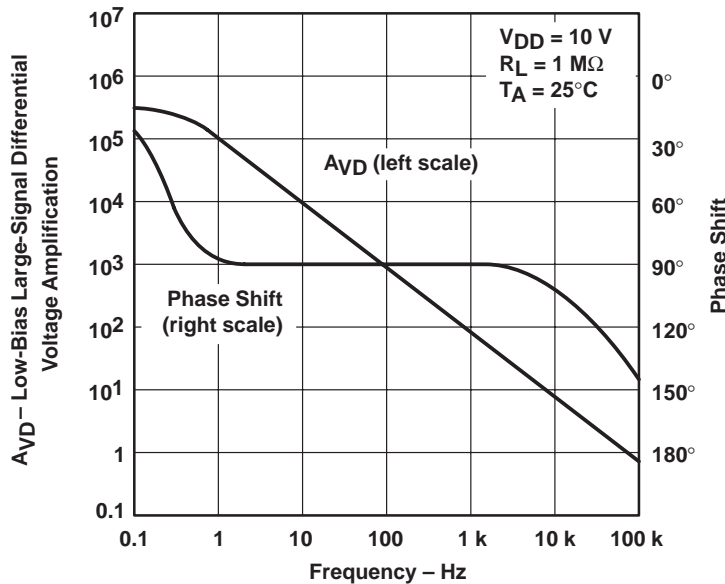

Figure 6

MEDIUM-BIAS LARGE-SIGNAL
 DIFFERENTIAL VOLTAGE AMPLIFICATION
 AND PHASE SHIFT

vs
 FREQUENCY

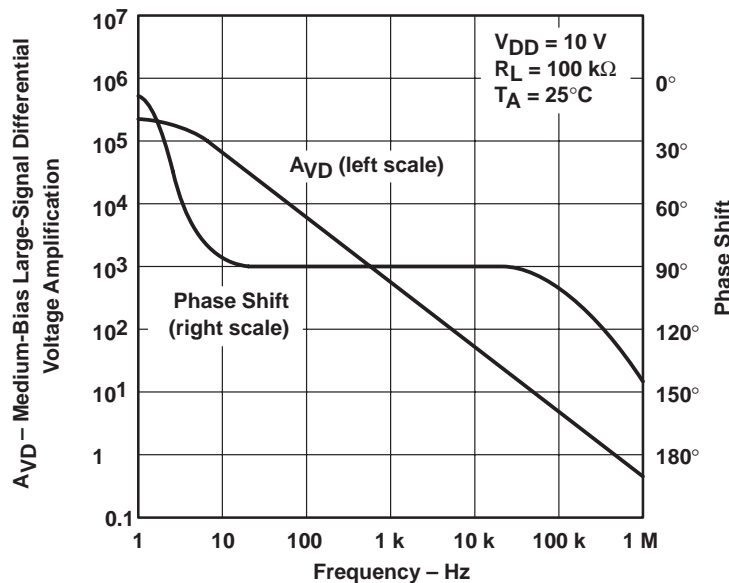

Figure 7

TYPICAL CHARACTERISTICS

HIGH-BIAS LARGE-SIGNAL
DIFFERENTIAL VOLTAGE AMPLIFICATION
AND PHASE SHIFT
VS
FREQUENCY

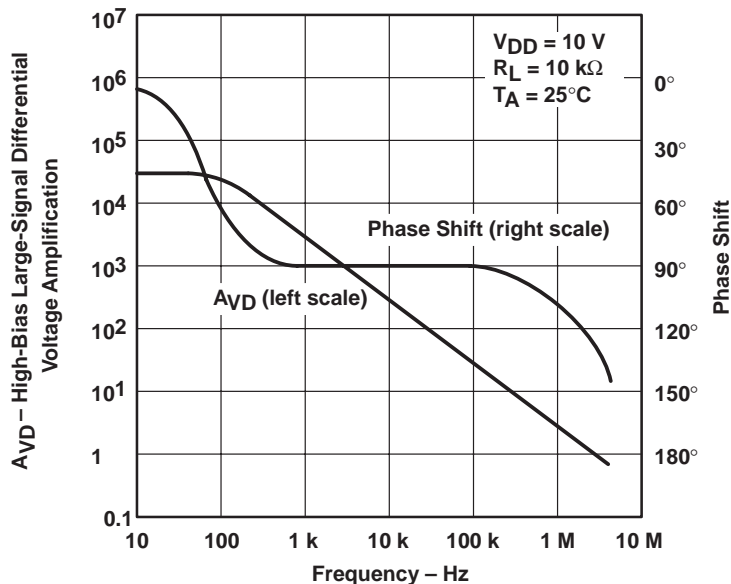

Figure 8

APPLICATION INFORMATION

latch-up avoidance

Junction-isolated CMOS circuits have an inherent parasitic PNP structure that can function as an SCR. Under certain conditions, this SCR may be triggered into a low-impedance state, resulting in excessive supply current. To avoid such conditions, no voltage greater than 0.3 V beyond the supply rails should be applied to any pin. In general, the operational amplifiers supplies should be established simultaneously with, or before, application of any input signals.

output stage considerations

The amplifier's output stage consists of a source-follower-connected pullup transistor and an open-drain pulldown transistor. The high-level output voltage (V_{OH}) is virtually independent of the I_{DD} selection and increases with higher values of V_{DD} and reduced output loading. The low-level output voltage (V_{OL}) decreases with reduced output current and higher input common-mode voltage. With no load, V_{OL} is essentially equal to the potential of V_{DD-}/GND .

supply configurations

Even though the TLC25_4C series is characterized for single-supply operation, they can be used effectively in a split-supply configuration if the input common-mode voltage (V_{ICR}), output swing (V_{OL} and V_{OH}), and supply voltage limits are not exceeded.

circuit layout precautions

Whenever extremely high circuit impedances are used, care must be exercised in layout, construction, board cleanliness, and supply filtering to avoid hum and noise pickup as well as excessive dc leakages.

IMPORTANT NOTICE

Texas Instruments and its subsidiaries (TI) reserve the right to make changes to their products or to discontinue any product or service without notice, and advise customers to obtain the latest version of relevant information to verify, before placing orders, that information being relied on is current and complete. All products are sold subject to the terms and conditions of sale supplied at the time of order acknowledgement, including those pertaining to warranty, patent infringement, and limitation of liability.

TI warrants performance of its semiconductor products to the specifications applicable at the time of sale in accordance with TI's standard warranty. Testing and other quality control techniques are utilized to the extent TI deems necessary to support this warranty. Specific testing of all parameters of each device is not necessarily performed, except those mandated by government requirements.

CERTAIN APPLICATIONS USING SEMICONDUCTOR PRODUCTS MAY INVOLVE POTENTIAL RISKS OF DEATH, PERSONAL INJURY, OR SEVERE PROPERTY OR ENVIRONMENTAL DAMAGE ("CRITICAL APPLICATIONS"). TI SEMICONDUCTOR PRODUCTS ARE NOT DESIGNED, AUTHORIZED, OR WARRANTED TO BE SUITABLE FOR USE IN LIFE-SUPPORT DEVICES OR SYSTEMS OR OTHER CRITICAL APPLICATIONS. INCLUSION OF TI PRODUCTS IN SUCH APPLICATIONS IS UNDERSTOOD TO BE FULLY AT THE CUSTOMER'S RISK.

In order to minimize risks associated with the customer's applications, adequate design and operating safeguards must be provided by the customer to minimize inherent or procedural hazards.

TI assumes no liability for applications assistance or customer product design. TI does not warrant or represent that any license, either express or implied, is granted under any patent right, copyright, mask work right, or other intellectual property right of TI covering or relating to any combination, machine, or process in which such semiconductor products or services might be or are used. TI's publication of information regarding any third party's products or services does not constitute TI's approval, warranty or endorsement thereof.