

# TLE2027, TLE2037, TLE2027A, TLE2037A, TLE2027Y, TLE2037Y EXCALIBUR LOW-NOISE HIGH-SPEED PRECISION OPERATIONAL AMPLIFIERS

SLOS192A – FEBRUARY 1997 REVISED MARCH 2002

- Outstanding Combination of dc Precision and AC Performance:

Unity-Gain Bandwidth . . . 15 MHz Typ

$V_n$  . . . . 3.3 nV/ $\sqrt{\text{Hz}}$  at  $f = 10$  Hz Typ,  
2.5 nV/ $\sqrt{\text{Hz}}$  at  $f = 1$  kHz Typ

$V_{IO}$  . . . . 25  $\mu\text{V}$  Max

$A_{VD}$  . . . 45 V/ $\mu\text{V}$  Typ With  $R_L = 2$  k $\Omega$ ,  
19 V/ $\mu\text{V}$  Typ With  $R_L = 600$   $\Omega$

- Available in Standard-Pinout Small-Outline Package
- Output Features Saturation Recovery Circuitry
- Macromodels and Statistical information

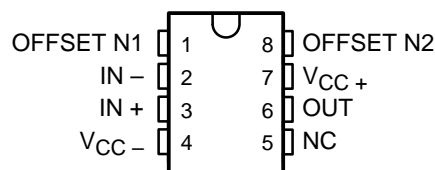
## description

The TLE20x7 and TLE20x7A contain innovative circuit design expertise and high-quality process control techniques to produce a level of ac performance and dc precision previously unavailable in single operational amplifiers. Manufactured using Texas Instruments state-of-the-art Excalibur process, these devices allow upgrades to systems that use lower-precision devices.

In the area of dc precision, the TLE20x7 and TLE20x7A offer maximum offset voltages of 100  $\mu\text{V}$  and 25  $\mu\text{V}$ , respectively, common-mode rejection ratio of 131 dB (typ), supply voltage rejection ratio of 144 dB (typ), and dc gain of 45 V/ $\mu\text{V}$  (typ).

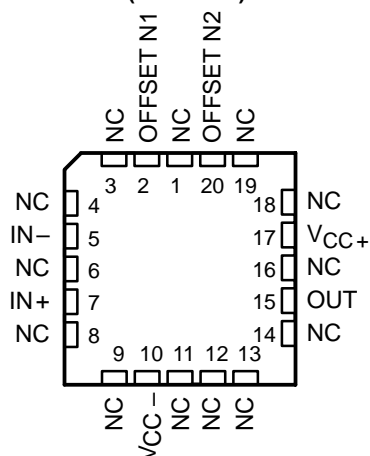
D, JG, OR P PACKAGE

(TOP VIEW)



FK PACKAGE

(TOP VIEW)



## AVAILABLE OPTIONS

$T_A$	$V_{IOmax}$ AT 25°C	PACKAGED DEVICES				CHIP FORM <sup>‡</sup> (Y)
		SMALL OUTLINE <sup>†</sup> (D)	CHIP CARRIER (FK)	CERAMIC DIP (JG)	PLASTIC DIP (P)	
0°C to 70°C	25 $\mu\text{V}$	TLE2027ACD TLE2037ACD	—	—	TLE2027ACP TLE2037ACP	TLE2027Y TLE2037Y
	100 $\mu\text{V}$	TLE2027CD TLE2037CD	—	—	TLE2027CP TLE2037CP	TLE2027Y TLE2037Y
-40°C to 105°C	25 $\mu\text{V}$	TLE2027AID TLE2037AID	—	—	TLE2027AIP TLE2037AIP	—
	100 $\mu\text{V}$	TLE2027ID TLE2037ID	—	—	TLE2027IP TLE2037IP	—
-55°C to 125°C	25 $\mu\text{V}$	TLE2027AMD TLE2037AMD	TLE2027AMFK TLE2037AMFK	TLE2027AMJG TLE2037AMJG	TLE2027AMP TLE2037AMP	—
	100 $\mu\text{V}$	TLE2027MD TLE2037MD	TLE2027MFK TLE2037MFK	TLE2027MJG TLE2037MJG	TLE2027MP TLE2037MP	—

<sup>†</sup> The D packages are available taped and reeled. Add R suffix to device type (e.g., TLE2027ACDR).

<sup>‡</sup> Chip forms are tested at 25°C only.



Please be aware that an important notice concerning availability, standard warranty, and use in critical applications of Texas Instruments semiconductor products and disclaimers thereto appears at the end of this data sheet.

PRODUCTION DATA information is current as of publication date. Products conform to specifications per the terms of Texas Instruments standard warranty. Production processing does not necessarily include testing of all parameters.

TEXAS  
INSTRUMENTS

POST OFFICE BOX 655303 • DALLAS, TEXAS 75265

Copyright © 2002, Texas Instruments Incorporated

# TLE2027, TLE2037, TLE2027A, TLE2037A, TLE2027Y, TLE2037Y EXCALIBUR LOW-NOISE HIGH-SPEED PRECISION OPERATIONAL AMPLIFIERS

SLOS192A – FEBRUARY 1997 REVISED MARCH 2002

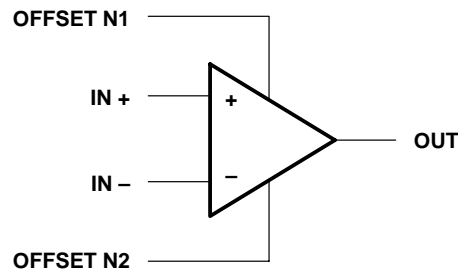
---

## description (continued)

The ac performance of the TLE2027 and TLE2037 is highlighted by a typical unity-gain bandwidth specification of 15 MHz, 55° of phase margin, and noise voltage specifications of 3.3 nV/ $\sqrt{\text{Hz}}$  and 2.5 nV/ $\sqrt{\text{Hz}}$  at frequencies of 10 Hz and 1 kHz respectively. The TLE2037 and TLE2037A have been decompensated for faster slew rate ( $-7.5 \text{ V}/\mu\text{s}$ , typical) and wider bandwidth (50 MHz). To ensure stability, the TLE2037 and TLE2037A should be operated with a closed-loop gain of 5 or greater.

Both the TLE20x7 and TLE20x7A are available in a wide variety of packages, including the industry-standard 8-pin small-outline version for high-density system applications. The C-suffix devices are characterized for operation from 0°C to 70°C. The I-suffix devices are characterized for operation from  $-40^\circ\text{C}$  to 105°C. The M-suffix devices are characterized for operation over the full military temperature range of  $-55^\circ\text{C}$  to 125°C.

## symbol

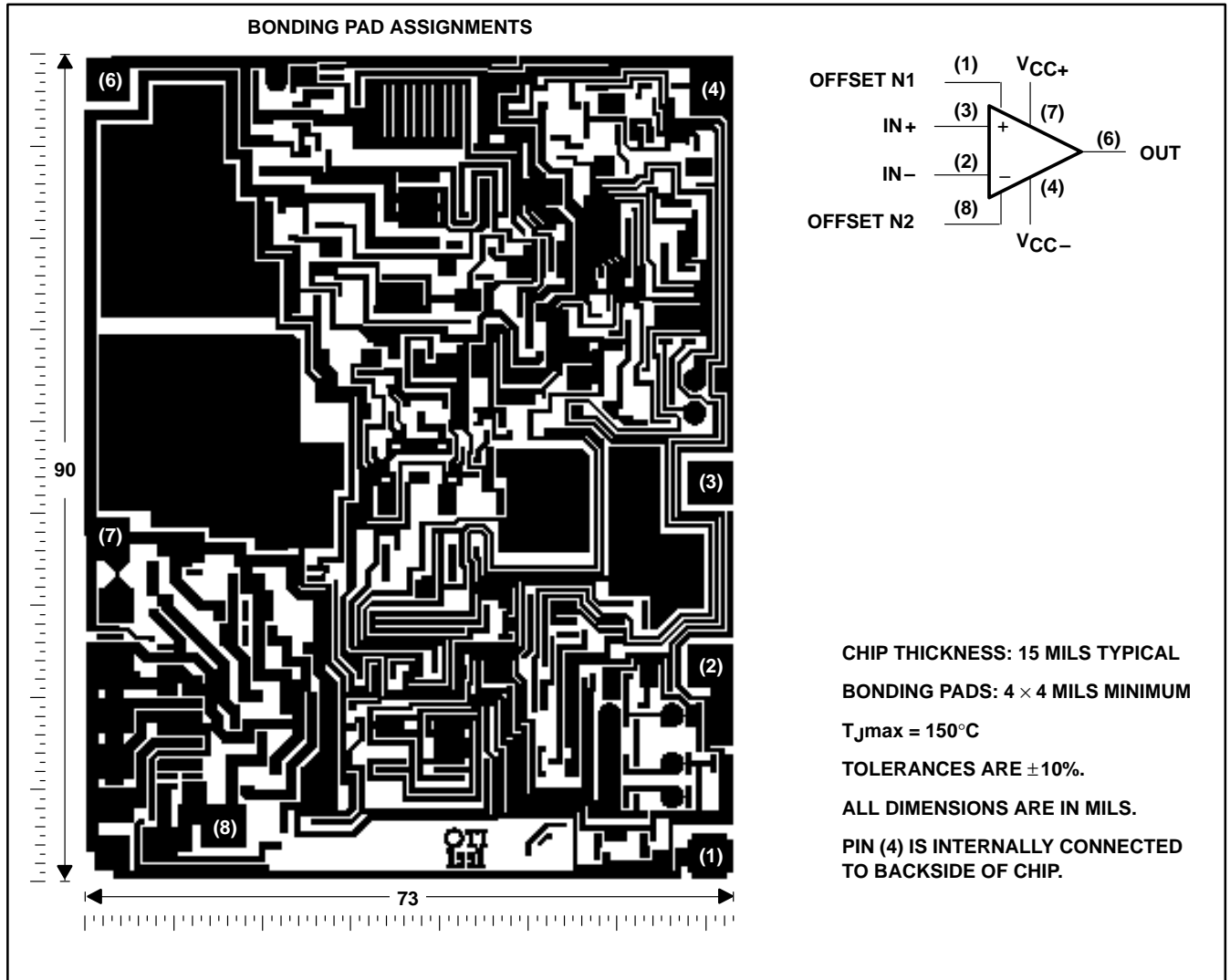


TLE2027, TLE2037, TLE2027A, TLE2037A, TLE2027Y, TLE2037Y  
**EXCALIBUR LOW-NOISE HIGH-SPEED  
 PRECISION OPERATIONAL AMPLIFIERS**

SLOS192A – FEBRUARY 1997 REVISED MARCH 2002

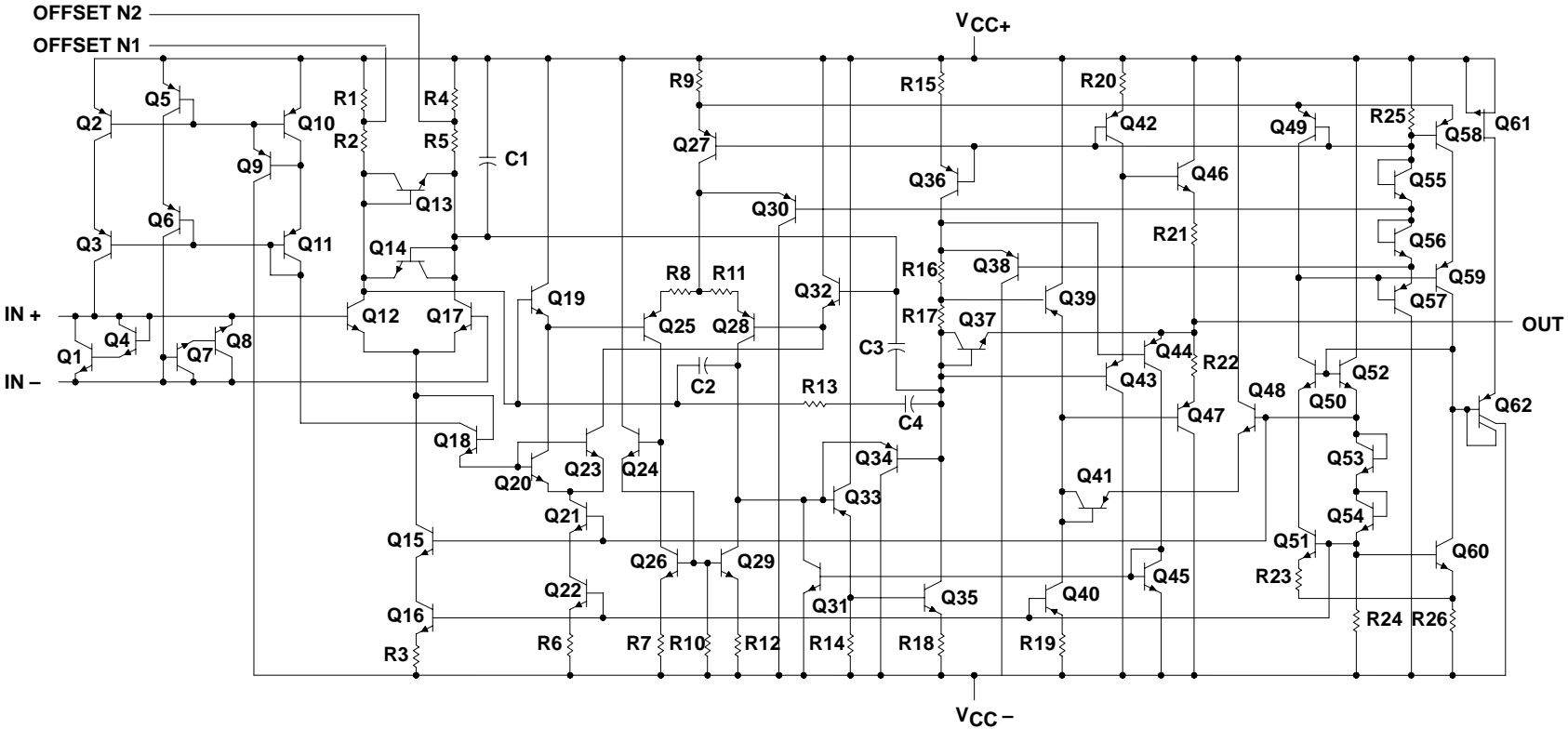
**TLE202xY chip information**

This chip, when properly assembled, displays characteristics similar to the TLE202xC. Thermal compression or ultrasonic bonding may be used on the doped-aluminum bonding pads. The chip may be mounted with conductive epoxy or a gold-silicon preform.



**TLE2027, TLE2037, TLE2027A, TLE2037A, TLE2027Y, TLE2037Y**  
**EXCALIBUR LOW-NOISE HIGH-SPEED**  
**PRECISION OPERATIONAL AMPLIFIERS**  
 SLOS192A - FEBRUARY 1997 REVISED MARCH 2002

**equivalent schematic**



ACTUAL DEVICE COMPONENT COUNT		
COMPONENT	TLE2027	TLE2037
Transistors	61	61
Resistors	26	26
epiFET	1	1
Capacitors	4	4

# TLE2027, TLE2037, TLE2027A, TLE2037A, TLE2027Y, TLE2037Y EXCALIBUR LOW-NOISE HIGH-SPEED PRECISION OPERATIONAL AMPLIFIERS

SLOS192A – FEBRUARY 1997 REVISED MARCH 2002

## absolute maximum ratings over operating free-air temperature range (unless otherwise noted)†

Supply voltage, $V_{CC+}$ (see Note 1)	19 V
Supply voltage, $V_{CC-}$	– 19 V
Differential input voltage, $V_{ID}$ (see Note 2)	$\pm 1.2$ V
Input voltage range, $V_I$ (any input)	$V_{CC\pm}$
Input current, $I_I$ (each Input)	$\pm 1$ mA
Output current, $I_O$	$\pm 50$ mA
Total current into $V_{CC+}$	50 mA
Total current out of $V_{CC-}$	50 mA
Duration of short-circuit current at (or below) 25°C (see Note 3)	unlimited
Continuous total power dissipation	See Dissipation Rating Table
Operating free-air temperature range, $T_A$ : C suffix	0°C to 70°C
I suffix	– 40°C to 105°C
M suffix	– 55°C to 125°C
Storage temperature range, $T_{stg}$	– 65°C to 150°C
Case temperature for 60 seconds, $T_C$ : FK package	260°C
Lead temperature 1,6 mm (1/16 inch) from case for 10 seconds: D or P package	260°C
Lead temperature 1,6 mm (1/16 inch) from case for 60 seconds: JG package	300°C

† Stresses beyond those listed under “absolute maximum ratings” may cause permanent damage to the device. These are stress ratings only, and functional operation of the device at these or any other conditions beyond those indicated under “recommended operating conditions” is not implied. Exposure to absolute-maximum-rated conditions for extended periods may affect device reliability.

- NOTES:
1. All voltage values, except differential voltages, are with respect to the midpoint between  $V_{CC+}$  and  $V_{CC-}$ .
  2. Differential voltages are at  $IN+$  with respect to  $IN-$ . Excessive current flows if a differential input voltage in excess of approximately  $\pm 1.2$  V is applied between the inputs unless some limiting resistance is used.
  3. The output may be shorted to either supply. Temperature and/or supply voltages must be limited to ensure that the maximum dissipation rating is not exceeded.

**DISSIPATION RATING TABLE**

PACKAGE	$T_A \leq 25^\circ\text{C}$	DERATING FACTOR ABOVE $T_A = 25^\circ\text{C}$	$T_A = 70^\circ\text{C}$	$T_A = 105^\circ\text{C}$	$T_A = 125^\circ\text{C}$
	POWER RATING		POWER RATING	POWER RATING	POWER RATING
D	725 mW	5.8 mW/°C	464 mW	261 mW	145 mW
FK	1375 mW	11.0 mW/°C	880 mW	495 mW	275 mW
JG	1050 mW	8.4 mW/°C	672 mW	378 mW	210 mW
P	1000 mW	8.0 mW/°C	640 mW	360 mW	200 mW

## recommended operating conditions

		C SUFFIX		I SUFFIX		M SUFFIX		UNIT
		MIN	MAX	MIN	MAX	MIN	MAX	
Supply voltage, $V_{CC\pm}$		$\pm 4$	$\pm 19$	$\pm 4$	$\pm 19$	$\pm 4$	$\pm 19$	V
Common-mode input voltage, $V_{IC}$	$T_A = 25^\circ\text{C}$	–11	11	–11	11	–11	11	V
	$T_A = \text{Full range}^\ddagger$	–10.5	10.5	–10.4	10.4	–10.2	10.2	
Operating free-air temperature, $T_A$		0	70	–40	105	–55	125	°C

‡ Full range is 0°C to 70°C for C-suffix devices, –40°C to 105°C for I-suffix devices, and –55°C to 125°C for M-suffix devices.



# TLE2027, TLE2037, TLE2027A, TLE2037A, TLE2027Y, TLE2037Y EXCALIBUR LOW-NOISE HIGH-SPEED PRECISION OPERATIONAL AMPLIFIERS

SLOS192A – FEBRUARY 1997 REVISED MARCH 2002

**TLE20x7C electrical characteristics at specified free-air temperature,  $V_{CC\pm} = \pm 15\text{ V}$  (unless otherwise noted)**

PARAMETER	TEST CONDITIONS	$T_A$ †	TLE20x7C			TLE20x7AC			UNIT
			MIN	TYP	MAX	MIN	TYP	MAX	
$V_{IO}$ Input offset voltage	$V_{IC} = 0, R_S = 50\ \Omega$	25°C	20	100		10	25	$\mu\text{V}$	
		Full range			145		70		
$\alpha_{VIO}$ Temperature coefficient of input offset voltage		Full range	0.4	1		0.2	1	$\mu\text{V}/^\circ\text{C}$	
Input offset voltage long-term drift (see Note 4)		25°C	0.006	1		0.006	1	$\mu\text{V}/\text{mo}$	
$I_{IO}$ Input offset current		25°C	6	90		6	90	nA	
		Full range			150		150		
$I_{IB}$ Input bias current	25°C	15	90		15	90	nA		
	Full range			150		150			
$V_{ICR}$ Common-mode input voltage range	$R_S = 50\ \Omega$	25°C	-11 to 11	-13 to 13		-11 to 11	-13 to 13	V	
		Full range	-10.5 to 10.5			-10.5 to 10.5			
$V_{OM+}$ Maximum positive peak output voltage swing	$R_L = 600\ \Omega$	25°C	10.5	12.9		10.5	12.9	V	
		Full range	10			10			
	$R_L = 2\ \text{k}\Omega$	25°C	12	13.2		12	13.2		
		Full range	11			11			
$V_{OM-}$ Maximum negative peak output voltage swing	$R_L = 600\ \Omega$	25°C	-10.5	-13		-10.5	-13	V	
		Full range	-10			-10			
	$R_L = 2\ \text{k}\Omega$	25°C	-12	-13.5		-12	-13.5		
		Full range	-11			-11			
$A_{VD}$ Large-signal differential voltage amplification	$V_O = \pm 11\ \text{V}, R_L = 2\ \text{k}\Omega$	25°C	5	45		10	45	$\text{V}/\mu\text{V}$	
	$V_O = \pm 10\ \text{V}, R_L = 2\ \text{k}\Omega$	Full range	2			4			
	$V_O = \pm 10\ \text{V}, R_L = 1\ \text{k}\Omega$	25°C	3.5	38		8	38		
		Full range	1			2.5			
	$V_O = \pm 10\ \text{V}, R_L = 600\ \Omega$	25°C	2	19		5	19		
		Full range	0.5			2			
$C_i$ Input capacitance		25°C	8		8		pF		
$z_o$ Open-loop output impedance	$I_O = 0$	25°C	50		50		$\Omega$		
CMRR Common-mode rejection ratio	$V_{IC} = V_{ICRmin}, R_S = 50\ \Omega$	25°C	100	131		117	131	dB	
		Full range	98			114			
$k_{SVR}$ Supply-voltage rejection ratio ( $\Delta V_{CC\pm} / \Delta V_{IO}$ )	$V_{CC\pm} = \pm 4\ \text{V to } \pm 18\ \text{V}, R_S = 50\ \Omega$	25°C	94	144		110	144	dB	
	$V_{CC\pm} = \pm 4\ \text{V to } \pm 18\ \text{V}, R_S = 50\ \Omega$	Full range	92			106			
$I_{CC}$ Supply current	$V_O = 0, \text{ No load}$	25°C	3.8	5.3		3.8	5.3	mA	
		Full range			5.6		5.6		

† Full range is 0°C to 70°C.

NOTE 4: Typical values are based on the input offset voltage shift observed through 168 hours of operating life test at  $T_A = 150^\circ\text{C}$  extrapolated to  $T_A = 25^\circ\text{C}$  using the Arrhenius equation and assuming an activation energy of 0.96 eV.



**TLE2027, TLE2037, TLE2027A, TLE2037A, TLE2027Y, TLE2037Y**  
**EXCALIBUR LOW-NOISE HIGH-SPEED**  
**PRECISION OPERATIONAL AMPLIFIERS**

SLOS192A – FEBRUARY 1997 REVISED MARCH 2002

**TLE20x7C operating characteristics at specified free-air temperature,  $V_{CC \pm} = \pm 15\text{ V}$ ,  $T_A = 25^\circ\text{C}$  (unless otherwise specified)**

PARAMETER	TEST CONDITIONS		TLE20x7C			TLE20x7AC			UNIT
			MIN	TYP	MAX	MIN	TYP	MAX	
SR	Slew rate at unity gain	$R_L = 2\text{ k}\Omega$ , $C_L = 100\text{ pF}$ , See Figure 1	TLE2027	1.7	2.8		1.7	2.8	V/ $\mu$ s
			TLE2037	6	7.5		6	7.5	
	$R_L = 2\text{ k}\Omega$ , $C_L = 100\text{ pF}$ , $T_A = 0^\circ\text{C}$ to $70^\circ\text{C}$ , See Figure 1	TLE2027	1.2			1.2			
		TLE2037	5			5			
$V_n$	Equivalent input noise voltage (see Figure 2)	$R_S = 20\ \Omega$ , $f = 10\text{ Hz}$		3.3	8		3.3	4.5	nV/ $\sqrt{\text{Hz}}$
			$R_S = 20\ \Omega$ , $f = 1\text{ kHz}$		2.5	4.5		2.5	
$V_N(\text{PP})$	Peak-to-peak equivalent input noise voltage	$f = 0.1\text{ Hz}$ to $10\text{ Hz}$		50	250		50	130	nV
$I_n$	Equivalent input noise current	$f = 10\text{ Hz}$		10	25		10	25	pA/ $\sqrt{\text{Hz}}$
		$f = 1\text{ kHz}$		0.8	1.8		0.8	1.8	
THD	Total harmonic distortion	$V_O = +10\text{ V}$ , $A_{VD} = 1$ , See Note 5	TLE2027	<0.002%			<0.002%		
		$V_O = +10\text{ V}$ , $A_{VD} = 5$ , See Note 5	TLE2037	<0.002%			<0.002%		
$B_1$	Unity-gain bandwidth (see Figure 3)	$R_L = 2\text{ k}\Omega$ , $C_L = 100\text{ pF}$	TLE2027	7	13		9	13	MHz
			TLE2037	35	50		35	50	
$B_{\text{OM}}$	Maximum output-swing bandwidth	$R_L = 2\text{ k}\Omega$	TLE2027	30			30		kHz
			TLE2037	80			80		
$\phi_m$	Phase margin at unity gain (see Figure 3)	$R_L = 2\text{ k}\Omega$ , $C_L = 100\text{ pF}$	TLE2027	$55^\circ$			$55^\circ$		
			TLE2037	$50^\circ$			$50^\circ$		

NOTE 5: Measured distortion of the source used in the analysis was 0.002%.

**TLE2027, TLE2037, TLE2027A, TLE2037A, TLE2027Y, TLE2037Y**  
**EXCALIBUR LOW-NOISE HIGH-SPEED**  
**PRECISION OPERATIONAL AMPLIFIERS**

SLOS192A – FEBRUARY 1997 REVISED MARCH 2002

**TLE20x7I electrical characteristics at specified free-air temperature,  $V_{CC\pm} = \pm 15\text{ V}$  (unless otherwise noted)**

PARAMETER	TEST CONDITIONS	$T_A$ †	TLE20x7I			TLE20x7AI			UNIT
			MIN	TYP	MAX	MIN	TYP	MAX	
$V_{IO}$ Input offset voltage	$V_{IC} = 0, R_S = 50\ \Omega$	25°C	20	100		10	25	$\mu\text{V}$	
		Full range			180		105		
$\alpha_{VIO}$ Temperature coefficient of input offset voltage		Full range	0.4	1		0.2	1	$\mu\text{V}/^\circ\text{C}$	
Input offset voltage long-term drift (see Note 4)		25°C	0.006	1		0.006	1	$\mu\text{V}/\text{mo}$	
$I_{IO}$ Input offset current		25°C	6	90		6	90	nA	
		Full range			150		150		
$I_{IB}$ Input bias current		25°C	15	90		15	90	nA	
		Full range			150		150		
$V_{ICR}$ Common-mode input voltage range	$R_S = 50\ \Omega$	25°C	-11 to 11	-13 to 13		-11 to 11	-13 to 13	V	
		Full range	-10.4 to 10.4			-10.4 to 10.4			
$V_{OM+}$ Maximum positive peak output voltage swing	$R_L = 600\ \Omega$	25°C	10.5	12.9		10.5	12.9	V	
		Full range	10			10			
	$R_L = 2\ \text{k}\Omega$	25°C	12	13.2		12	13.2		
		Full range	11			11			
$V_{OM-}$ Maximum negative peak output voltage swing	$R_L = 600\ \Omega$	25°C	-10.5	-13		-10.5	-13	V	
		Full range	-10			-10			
	$R_L = 2\ \text{k}\Omega$	25°C	-12	-13.5		-12	-13.5		
		Full range	-11			-11			
$A_{VD}$ Large-signal differential voltage amplification	$V_O = \pm 11\ \text{V}, R_L = 2\ \text{k}\Omega$	25°C	5	45		10	45	$\text{V}/\mu\text{V}$	
	$V_O = \pm 10\ \text{V}, R_L = 2\ \text{k}\Omega$	Full range	2			3.5			
	$V_O = \pm 10\ \text{V}, R_L = 1\ \text{k}\Omega$	25°C	3.5	38		8	38		
		Full range	1			2.2			
	$V_O = \pm 10\ \text{V}, R_L = 600\ \Omega$	25°C	2	19		5	19		
		Full range	0.5			1.1			
$C_i$ Input capacitance		25°C		8		8	pF		
$z_o$ Open-loop output impedance	$I_O = 0$	25°C		50		50	$\Omega$		
CMRR Common-mode rejection ratio	$V_{IC} = V_{ICRmin}, R_S = 50\ \Omega$	25°C	100	131		117	131	dB	
		Full range	96			113			
$k_{SVR}$ Supply-voltage rejection ratio ( $\Delta V_{CC\pm} / \Delta V_{IO}$ )	$V_{CC\pm} = \pm 4\ \text{V to } \pm 18\ \text{V}, R_S = 50\ \Omega$	25°C	94	144		110	144	dB	
	$V_{CC\pm} = \pm 4\ \text{V to } \pm 18\ \text{V}, R_S = 50\ \Omega$	Full range	90			105			
$I_{CC}$ Supply current	$V_O = 0, \text{ No load}$	25°C	3.8	5.3		3.8	5.3	mA	
		Full range			5.6		5.6		

† Full range is -40°C to 105°C.

NOTE 4: Typical values are based on the input offset voltage shift observed through 168 hours of operating life test at  $T_A = 150^\circ\text{C}$  extrapolated to  $T_A = 25^\circ\text{C}$  using the Arrhenius equation and assuming an activation energy of 0.96 eV.



**TLE2027, TLE2037, TLE2027A, TLE2037A, TLE2027Y, TLE2037Y**  
**EXCALIBUR LOW-NOISE HIGH-SPEED**  
**PRECISION OPERATIONAL AMPLIFIERS**

SLOS192A – FEBRUARY 1997 REVISED MARCH 2002

**TLE20x7I operating characteristics at specified free-air temperature,  $V_{CC \pm} = \pm 15\text{ V}$ ,  $T_A = 25^\circ\text{C}$  (unless otherwise specified)**

PARAMETER	TEST CONDITIONS		TLE20x7I			TLE20x7AI			UNIT
			MIN	TYP	MAX	MIN	TYP	MAX	
SR	Slew rate at unity gain	$R_L = 2\text{ k}\Omega$ , $C_L = 100\text{ pF}$ , See Figure 1	TLE2027	1.7	2.8		1.7	2.8	V/ $\mu\text{s}$
			TLE2037	6	7.5		6	7.5	
	$R_L = 2\text{ k}\Omega$ , $C_L = 100\text{ pF}$ , $T_A = -40^\circ\text{C}$ to $85^\circ\text{C}$ , See Figure 1	TLE2027	1.1			1.1			
		TLE2037	4.7			4.7			
$V_n$	Equivalent input noise voltage (see Figure 2)	$R_S = 20\ \Omega$ , $f = 10\text{ Hz}$		3.3	8		3.3	4.5	nV/ $\sqrt{\text{Hz}}$
			$R_S = 20\ \Omega$ , $f = 1\text{ kHz}$		2.5	4.5		2.5	
$V_N(\text{PP})$	Peak-to-peak equivalent input noise voltage	$f = 0.1\text{ Hz}$ to $10\text{ Hz}$		50	250		50	130	nV
$I_n$	Equivalent input noise current	$f = 10\text{ Hz}$		10	25		10	25	pA/ $\sqrt{\text{Hz}}$
		$f = 1\text{ kHz}$		0.8	1.8		0.8	1.8	
THD	Total harmonic distortion	$V_O = +10\text{ V}$ , $A_{VD} = 1$ , See Note 5	TLE2027	< 0.002%			< 0.002%		
		$V_O = +10\text{ V}$ , $A_{VD} = 5$ , See Note 5	TLE2037	< 0.002%			< 0.002%		
$B_1$	Unity-gain bandwidth (see Figure 3)	$R_L = 2\text{ k}\Omega$ , $C_L = 100\text{ pF}$	TLE2027	7	13		9	13	MHz
			TLE2037	35	50		35	50	
$B_{OM}$	Maximum output-swing bandwidth	$R_L = 2\text{ k}\Omega$	TLE2027	30			30		kHz
			TLE2037	80			80		
$\phi_m$	Phase margin at unity gain (see Figure 3)	$R_L = 2\text{ k}\Omega$ , $C_L = 100\text{ pF}$	TLE2027	55°			55°		
			TLE2037	50°			50°		

NOTE 5: Measured distortion of the source used in the analysis was 0.002%.

**TLE2027, TLE2037, TLE2027A, TLE2037A, TLE2027Y, TLE2037Y**  
**EXCALIBUR LOW-NOISE HIGH-SPEED**  
**PRECISION OPERATIONAL AMPLIFIERS**

SLOS192A – FEBRUARY 1997 REVISED MARCH 2002

**TLE20x7M electrical characteristics at specified free-air temperature,  $V_{CC\pm} = \pm 15\text{ V}$  (unless otherwise noted)**

PARAMETER	TEST CONDITIONS	$T_A$ †	TLE20x7M			TLE20x7AM			UNIT
			MIN	TYP	MAX	MIN	TYP	MAX	
$V_{IO}$ Input offset voltage	$V_{IC} = 0, R_S = 50\ \Omega$	25°C	20	100		10	25	$\mu\text{V}$	
		Full range			200		105		
$\alpha_{VIO}$ Temperature coefficient of input offset voltage		Full range	0.4	1*		0.2	1*	$\mu\text{V}/^\circ\text{C}$	
Input offset voltage long-term drift (see Note 4)		25°C	0.006	1*		0.006	1*	$\mu\text{V}/\text{mo}$	
$I_{IO}$ Input offset current		25°C	6	90		6	90	nA	
		Full range			150		150		
$I_{IB}$ Input bias current	25°C	15	90		15	90	nA		
	Full range			150		150			
$V_{ICR}$ Common-mode input voltage range	$R_S = 50\ \Omega$	25°C	-11 to 11	-13 to 13		-11 to 11	-13 to 13	V	
		Full range	-10.3 to 10.3			-10.4 to 10.4			
$V_{OM+}$ Maximum positive peak output voltage swing	$R_L = 600\ \Omega$	25°C	10.5	12.9		10.5	12.9	V	
		Full range	10			10			
	$R_L = 2\ \text{k}\Omega$	25°C	12	13.2		12	13.2		
		Full range	11			11			
$V_{OM-}$ Maximum negative peak output voltage swing	$R_L = 600\ \Omega$	25°C	-10.5	-13		-10.5	-13	V	
		Full range	-10			-10			
	$R_L = 2\ \text{k}\Omega$	25°C	-12	-13.5		-12	-13.5		
		Full range	-11			-11			
$A_{VD}$ Large-signal differential voltage amplification	$V_O = \pm 11\ \text{V}, R_L = 2\ \text{k}\Omega$	25°C	5	45		10	45	$\text{V}/\mu\text{V}$	
	$V_O = \pm 10\ \text{V}, R_L = 2\ \text{k}\Omega$	Full range	2.5			3.5			
	$V_O = \pm 10\ \text{V}, R_L = 1\ \text{k}\Omega$	25°C	3.5	38		8	38		
		Full range	1.8			2.2			
	$V_O = \pm 10\ \text{V}, R_L = 600\ \Omega$	25°C	2	19		5	19		
$C_i$ Input capacitance		25°C	8			8	pF		
$z_o$ Open-loop output impedance	$I_O = 0$	25°C	50			50	$\Omega$		
CMRR Common-mode rejection ratio	$V_{IC} = V_{ICRmin}, R_S = 50\ \Omega$	25°C	100	131		117	131	dB	
		Full range	96			113			
$k_{SVR}$ Supply-voltage rejection ratio ( $\Delta V_{CC\pm} / \Delta V_{IO}$ )	$V_{CC\pm} = \pm 4\ \text{V to } \pm 18\ \text{V}, R_S = 50\ \Omega$	25°C	94	144		110	144	dB	
	$V_{CC\pm} = \pm 4\ \text{V to } \pm 18\ \text{V}, R_S = 50\ \Omega$	Full range	90			105			
$I_{CC}$ Supply current	$V_O = 0, \text{ No load}$	25°C	3.8	5.3		3.8	5.3	mA	
		Full range			5.6		5.6		

\* On products compliant to MIL-PRF-38535, this parameter is not production tested.

† Full range is -55°C to 125°C.

NOTE 4: Typical values are based on the input offset voltage shift observed through 168 hours of operating life test at  $T_A = 150^\circ\text{C}$  extrapolated to  $T_A = 25^\circ\text{C}$  using the Arrhenius equation and assuming an activation energy of 0.96 eV.



**TLE2027, TLE2037, TLE2027A, TLE2037A, TLE2027Y, TLE2037Y**  
**EXCALIBUR LOW-NOISE HIGH-SPEED**  
**PRECISION OPERATIONAL AMPLIFIERS**

SLOS192A – FEBRUARY 1997 REVISED MARCH 2002

**TLE20x7M operating characteristics at specified free-air temperature,  $V_{CC} \pm = \pm 15\text{ V}$ ,  $T_A = 25^\circ\text{C}$  (unless otherwise specified)**

PARAMETER	TEST CONDITIONS		TLE20x7M			TLE20x7AM			UNIT
			MIN	TYP	MAX	MIN	TYP	MAX	
SR	Slew rate at unity gain	$R_L = 2\text{ k}\Omega$ , $C_L = 100\text{ pF}$ , See Figure 1	TLE2027	1.7	2.8		1.7	2.8	V/ $\mu$ s
			TLE2037	6*	7.5		6*	7.5	
	$R_L = 2\text{ k}\Omega$ , $C_L = 100\text{ pF}$ , $T_A = -55^\circ\text{C}$ to $125^\circ\text{C}$ , See Figure 1	TLE2027	1			1			
		TLE2037	4.4*			4.4*			
$V_n$	Equivalent input noise voltage (see Figure 2)	$R_S = 20\ \Omega$ , $f = 10\text{ Hz}$		3.3	8*		3.3	4.5*	nV/ $\sqrt{\text{Hz}}$
			$R_S = 20\ \Omega$ , $f = 1\text{ kHz}$		2.5	4.5*		2.5	
$V_N(\text{PP})$	Peak-to-peak equivalent input noise voltage	$f = 0.1\text{ Hz}$ to $10\text{ Hz}$		50	250*		50	130*	nV
$I_n$	Equivalent input noise current	$f = 10\text{ Hz}$		1.5	4*		1.5	4*	pA/ $\sqrt{\text{Hz}}$
		$f = 1\text{ kHz}$		0.4	0.6*		0.4	0.6*	
THD	Total harmonic distortion	$V_O = +10\text{ V}$ , $A_{VD} = 1$ , See Note 5	TLE2027	< 0.002%			< 0.002%		
		$V_O = +10\text{ V}$ , $A_{VD} = 5$ , See Note 5	TLE2037	< 0.002%			< 0.002%		
$B_1$	Unity-gain bandwidth (see Figure 3)	$R_L = 2\text{ k}\Omega$ , $C_L = 100\text{ pF}$	TLE2027	7*	13		9*	13	MHz
			TLE2037	35	50		35	50	
$B_{OM}$	Maximum output-swing bandwidth	$R_L = 2\text{ k}\Omega$	TLE2027	30			30		kHz
			TLE2037	80			80		
$\phi_m$	Phase margin at unity gain (see Figure 3)	$R_L = 2\text{ k}\Omega$ , $C_L = 100\text{ pF}$	TLE2027	$55^\circ$			$55^\circ$		
			TLE2037	$50^\circ$			$50^\circ$		

\* On products compliant to MIL-PRF-38535, this parameter is not production tested.

NOTE 5: Measured distortion of the source used in the analysis was 0.002%.

**TLE2027, TLE2037, TLE2027A, TLE2037A, TLE2027Y, TLE2037Y**  
**EXCALIBUR LOW-NOISE HIGH-SPEED**  
**PRECISION OPERATIONAL AMPLIFIERS**

SLOS192A – FEBRUARY 1997 REVISED MARCH 2002

**TLE20x7Y electrical characteristics,  $V_{CC\pm} = \pm 15\text{ V}$ ,  $T_A = 25^\circ\text{C}$  (unless otherwise noted)**

PARAMETER	TEST CONDITIONS	TLE20x7Y			UNIT
		MIN	TYP	MAX	
$V_{IO}$ Input offset voltage	$V_{IC} = 0, \quad R_S = 50\ \Omega$	20			$\mu\text{V}$
Input offset voltage long-term drift (see Note 4)		0.006			$\mu\text{V}/\text{mo}$
$I_{IO}$ Input offset current		6			nA
$I_{IB}$ Input bias current		15			nA
$V_{ICR}$ Common-mode input voltage range	$R_S = 50\ \Omega$	-13 to 13			V
$V_{OM+}$ Maximum positive peak output voltage swing	$R_L = 600\ \Omega$	12.9			V
	$R_L = 2\ \text{k}\Omega$	13.2			
$V_{OM-}$ Maximum negative peak output voltage swing	$R_L = 600\ \Omega$	-13			V
	$R_L = 2\ \text{k}\Omega$	-13.5			
$A_{VD}$ Large-signal differential voltage amplification	$V_O = \pm 11\ \text{V}, \quad R_L = 2\ \text{k}\Omega$	45			V/ $\mu\text{V}$
	$V_O = \pm 10\ \text{V}, \quad R_L = 1\ \text{k}\Omega$	38			
	$V_O = \pm 10\ \text{V}, \quad R_L = 600\ \Omega$	19			
$C_i$ Input capacitance		8			pF
$z_o$ Open-loop output impedance	$I_O = 0$	50			$\Omega$
CMRR Common-mode rejection ratio	$V_{IC} = V_{ICRmin}, \quad R_S = 50\ \Omega$	131			dB
$k_{SVR}$ Supply-voltage rejection ratio ( $\Delta V_{CC\pm} / \Delta V_{IO}$ )	$V_{CC\pm} = \pm 4\ \text{V to } \pm 18\ \text{V}, \quad R_S = 50\ \Omega$	144			dB
$I_{CC}$ Supply current	$V_O = 0, \quad \text{No load}$	3.8			mA

NOTE 4: Typical values are based on the input offset voltage shift observed through 168 hours of operating life test at  $T_A = 150^\circ\text{C}$  extrapolated to  $T_A = 25^\circ\text{C}$  using the Arrhenius equation and assuming an activation energy of 0.96 eV.



**TLE2027, TLE2037, TLE2027A, TLE2037A, TLE2027Y, TLE2037Y**  
**EXCALIBUR LOW-NOISE HIGH-SPEED**  
**PRECISION OPERATIONAL AMPLIFIERS**

SLOS192A – FEBRUARY 1997 REVISED MARCH 2002

**TLE20x7Y operating characteristics at specified free-air temperature,  $V_{CC \pm} = \pm 15\text{ V}$**

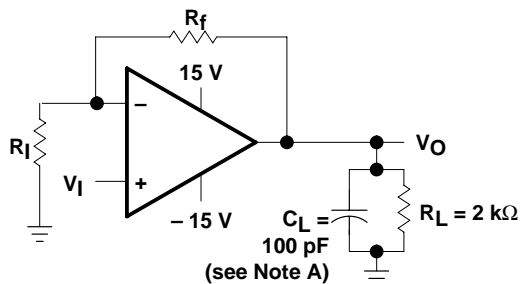
PARAMETER		TEST CONDITIONS		TLE20x7Y			UNIT
				MIN	TYP	MAX	
SR	Slew rate at unity gain	$R_L = 2\text{ k}\Omega$ , $C_L = 100\text{ pF}$ , See Figure 1	TLE2027	2.8		V/ $\mu\text{s}$	
			TLE2037	7.5			
$V_n$	Equivalent input noise voltage (see Figure 2)	$R_S = 20\ \Omega$ , $f = 10\text{ Hz}$	3.3		nV/ $\sqrt{\text{Hz}}$		
			$R_S = 20\ \Omega$ , $f = 1\text{ kHz}$	2.5			
$V_{N(PP)}$	Peak-to-peak equivalent input noise voltage	$f = 0.1\text{ Hz to }10\text{ Hz}$	50		nV		
$I_n$	Equivalent input noise current	$f = 10\text{ Hz}$	10		pA/ $\sqrt{\text{Hz}}$		
		$f = 1\text{ kHz}$	0.8				
THD	Total harmonic distortion	$V_O = +10\text{ V}$ , $A_{VD} = 1$ , See Note 5	TLE2027	<0.002%			
		$V_O = +10\text{ V}$ , $A_{VD} = 5$ , See Note 5	TLE2037	<0.002%			
$B_1$	Unity-gain bandwidth (see Figure 3)	$R_L = 2\text{ k}\Omega$ , $C_L = 100\text{ pF}$	TLE2027	13		MHz	
			TLE2037	50			
$B_{OM}$	Maximum output-swing bandwidth	$R_L = 2\text{ k}\Omega$	TLE2027	30		kHz	
			TLE2037	80			
$\phi_m$	Phase margin at unity gain (see Figure 3)	$R_L = 2\text{ k}\Omega$ , $C_L = 100\text{ pF}$	TLE2027	55°			
			TLE2037	50°			

NOTE 5: Measured distortion of the source used in the analysis was 0.002%.

**TLE2027, TLE2037, TLE2027A, TLE2037A, TLE2027Y, TLE2037Y**  
**EXCALIBUR LOW-NOISE HIGH-SPEED**  
**PRECISION OPERATIONAL AMPLIFIERS**

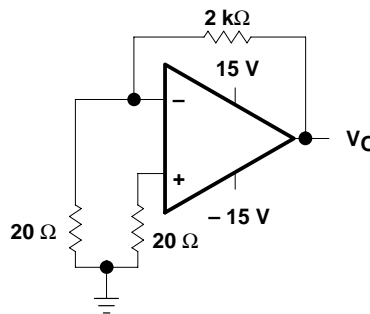
SLOS192A – FEBRUARY 1997 REVISED MARCH 2002

**PARAMETER MEASUREMENT INFORMATION**

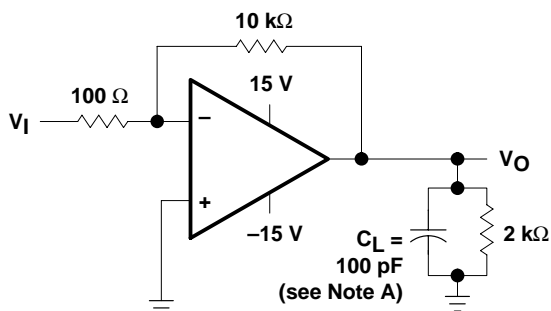


NOTE A:  $C_L$  includes fixture capacitance.

**Figure 1. Slew-Rate Test Circuit**

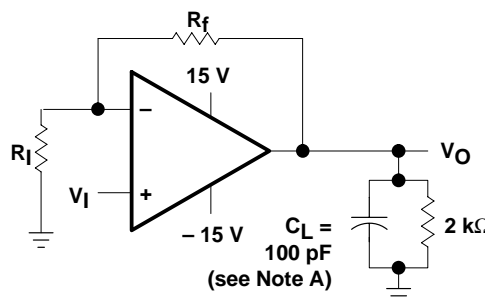


**Figure 2. Noise-Voltage Test Circuit**



NOTE A:  $C_L$  includes fixture capacitance.

**Figure 3. Unity-Gain Bandwidth and Phase-Margin Test Circuit (TLE2027 Only)**



NOTES: A.  $C_L$  includes fixture capacitance.  
 B. For the TLE2037 and TLE2037A,  $A_{VD}$  must be  $\geq 5$ .

**Figure 4. Small-Signal Pulse-Response Test Circuit**

**typical values**

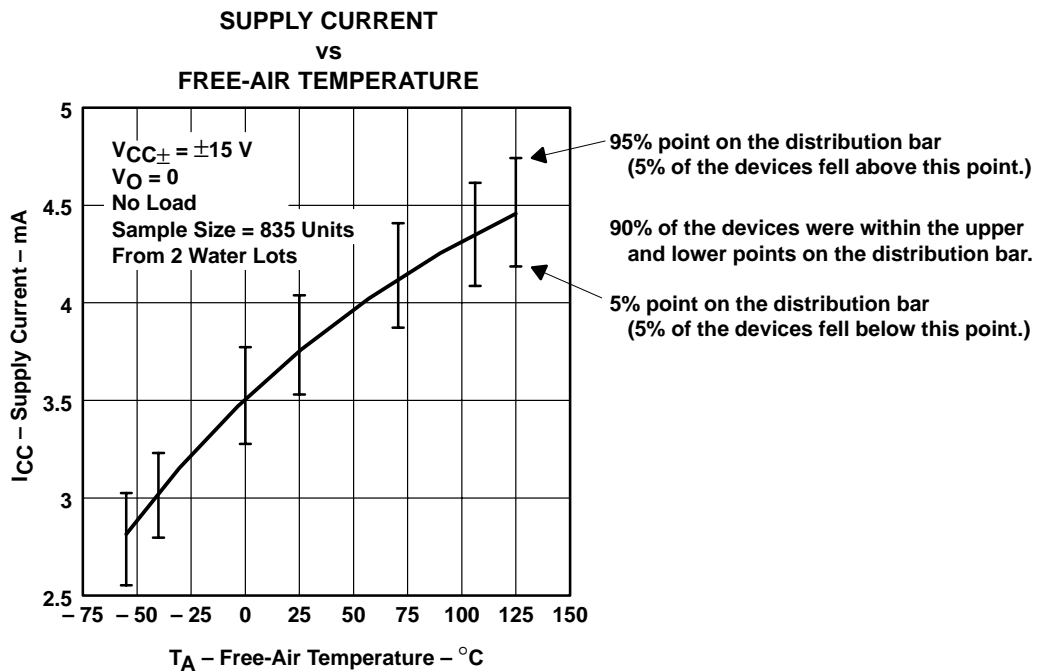
Typical values presented in this data sheet represent the median (50% point) of device parametric performance.

**initial estimates of parameter distributions**

In the ongoing program of improving data sheets and supplying more information to our customers, Texas Instruments has added an estimate of not only the typical values but also the spread around these values. These are in the form of distribution bars that show the 95% (upper) points and the 5% (lower) points from the characterization of the initial wafer lots of this new device type (see Figure 5). The distribution bars are shown at the points where data was actually collected. The 95% and 5% points are used instead of  $\pm 3$  sigma since some of the distributions are not true Gaussian distributions.

The number of units tested and the number of different wafer lots used are on all of the graphs where distribution bars are shown. As noted in Figure 5, there were a total of 835 units from two wafer lots. In this case, there is a good estimate for the within-lot variability and a possibly poor estimate of the lot-to-lot variability. This is always the case on newly released products since there can only be data available from a few wafer lots.

The distribution bars are not intended to replace the minimum and maximum limits in the electrical tables. Each distribution bar represents 90% of the total units tested at a specific temperature. While 10% of the units tested fell outside any given distribution bar, this should not be interpreted to mean that the same individual devices fell outside every distribution bar.



**Figure 5. Sample Graph With Distribution Bars**

**TLE2027, TLE2037, TLE2027A, TLE2037A, TLE2027Y, TLE2037Y**  
**EXCALIBUR LOW-NOISE HIGH-SPEED**  
**PRECISION OPERATIONAL AMPLIFIERS**

SLOS192A – FEBRUARY 1997 REVISED MARCH 2002

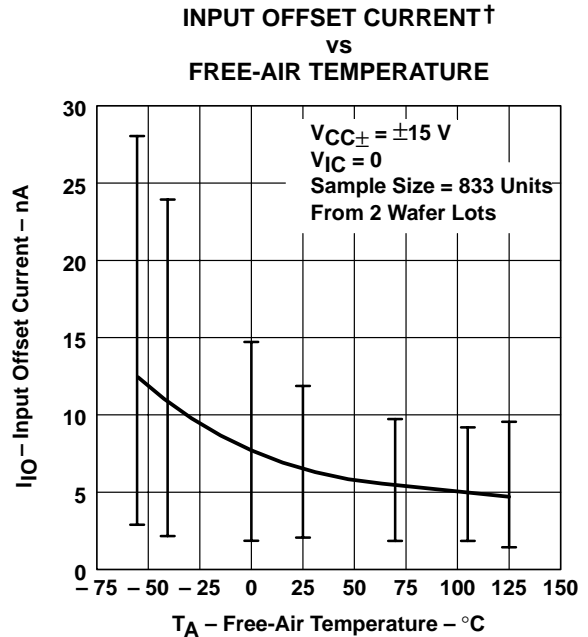
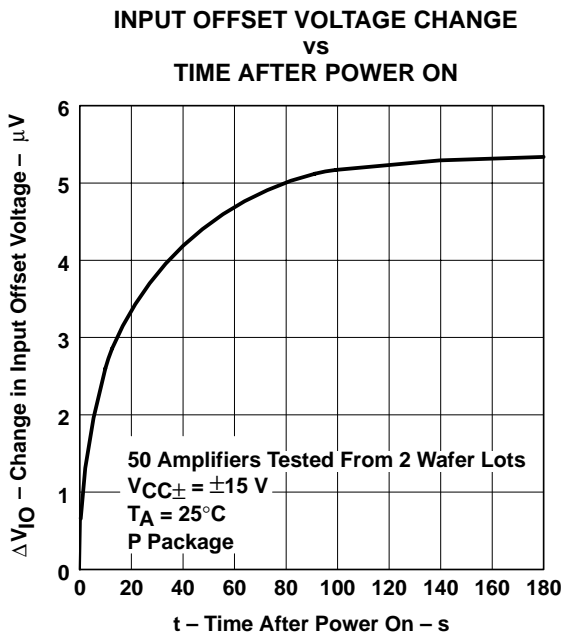
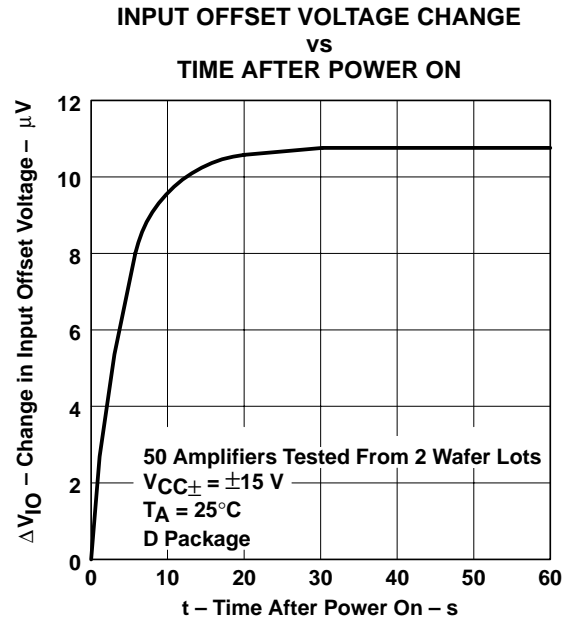
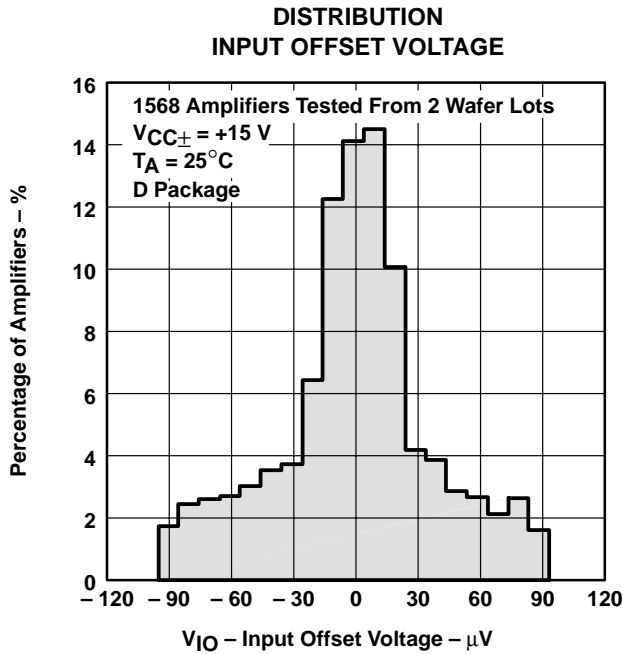
**TYPICAL CHARACTERISTICS**

**Table of Graphs**

		<b>FIGURE</b>	
$V_{IO}$	Input offset voltage	Distribution	6, 7
$\Delta V_{IO}$	Input offset voltage change	vs Time after power on	8, 9
$I_{IO}$	Input offset current	vs Free-air temperature	10
$I_{IB}$	Input bias current	vs Free-air temperature vs Common-mode input voltage	11 12
$I_I$	Input current	vs Differential input voltage	13
$V_{O(PP)}$	Maximum peak-to-peak output voltage	vs Frequency	14, 15
$V_{OM}$	Maximum (positive/negative) peak output voltage	vs Load resistance vs Free-air temperature	16, 17 18, 19
$A_{VD}$	Large-signal differential voltage amplification	vs Supply voltage vs Load resistance vs Frequency vs Free-air temperature	20 21 22 – 25 26
$z_o$	Output impedance	vs Frequency	27
CMRR	Common-mode rejection ratio	vs Frequency	28
$k_{SVR}$	Supply-voltage rejection ratio	vs Frequency	29
$I_{OS}$	Short-circuit output current	vs Supply voltage vs Elapsed time vs Free-air temperature	30, 31 32, 33 34, 35
$I_{CC}$	Supply current	vs Supply voltage vs Free-air temperature	36 37
	Voltage-follower pulse response	Small signal Large signal	38, 40 39, 41
$V_n$	Equivalent input noise voltage	vs Frequency	42
	Noise voltage (referred to input)	Over 10-second interval	43
$B_1$	Unity-gain bandwidth	vs Supply voltage vs Load capacitance	44 45
	Gain bandwidth product	vs Supply voltage vs Load capacitance	46 47
SR	Slew rate	vs Free-air temperature	48, 49
$\phi_m$	Phase margin	vs Supply voltage vs Load capacitance vs Free-air temperature	50, 51 52, 53 54, 55
	Phase shift	vs Frequency	22 – 25



**TYPICAL CHARACTERISTICS**

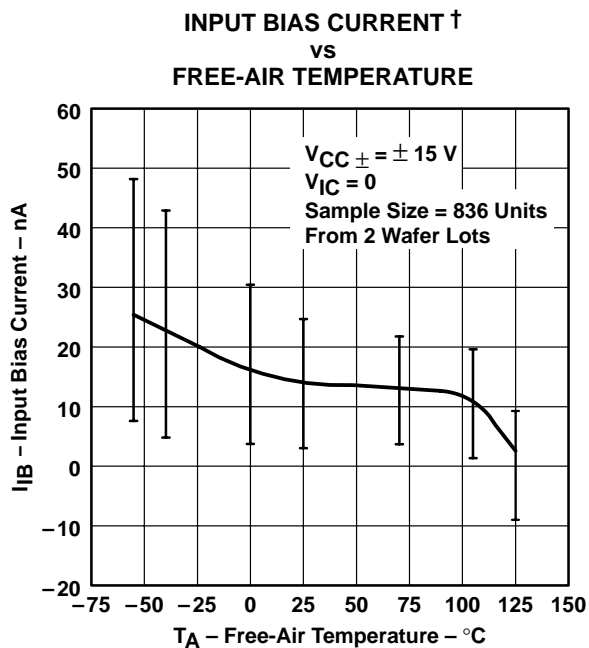


† Data at high and low temperatures are applicable only within the rated operating free-air temperature ranges of the various devices.

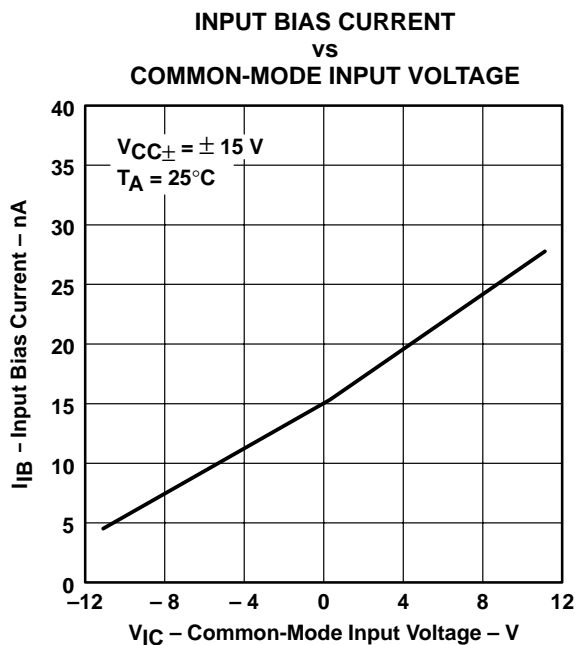
**TLE2027, TLE2037, TLE2027A, TLE2037A, TLE2027Y, TLE2037Y**  
**EXCALIBUR LOW-NOISE HIGH-SPEED**  
**PRECISION OPERATIONAL AMPLIFIERS**

SLOS192A – FEBRUARY 1997 REVISED MARCH 2002

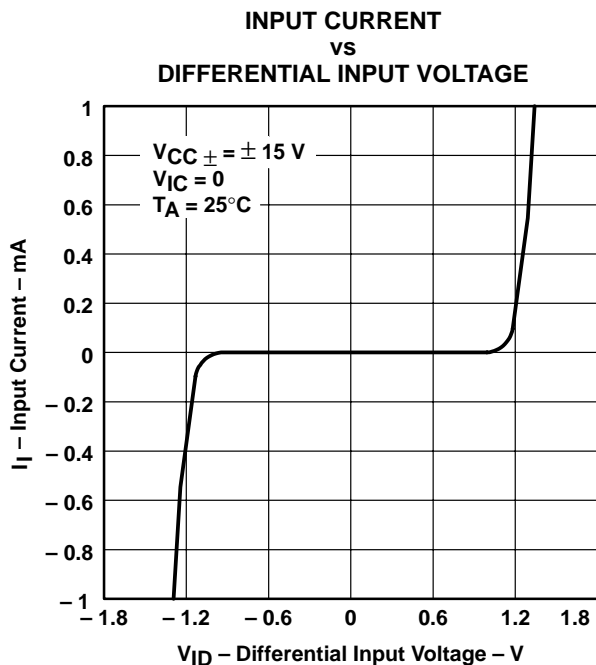
**TYPICAL CHARACTERISTICS**



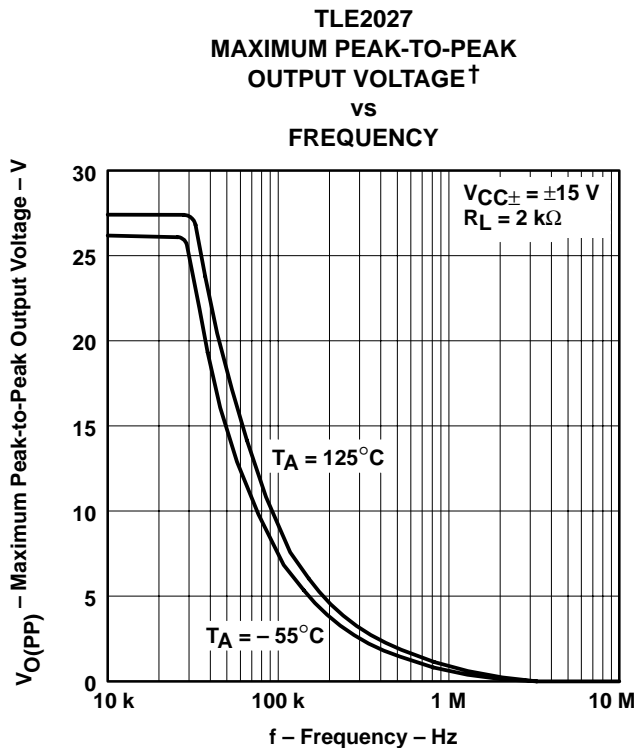
**Figure 10**



**Figure 11**



**Figure 12**



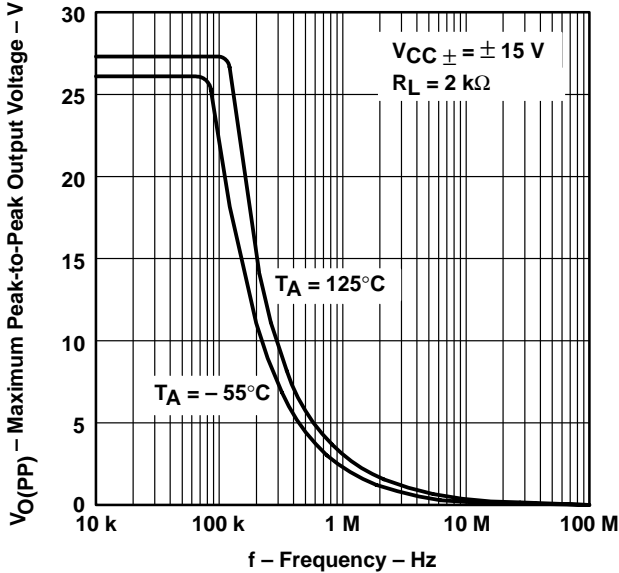
**Figure 13**

† Data at high and low temperatures are applicable only within the rated operating free-air temperature ranges of the various devices.



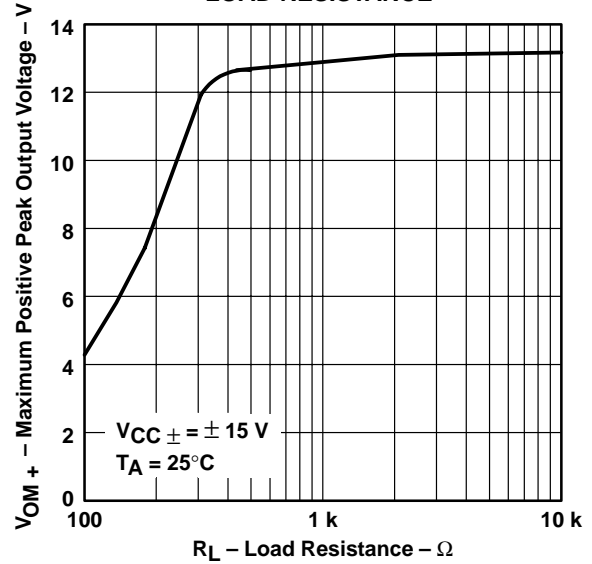
**TYPICAL CHARACTERISTICS**

**TLE2037  
 MAXIMUM PEAK-TO-PEAK  
 OUTPUT VOLTAGE†  
 vs  
 FREQUENCY**



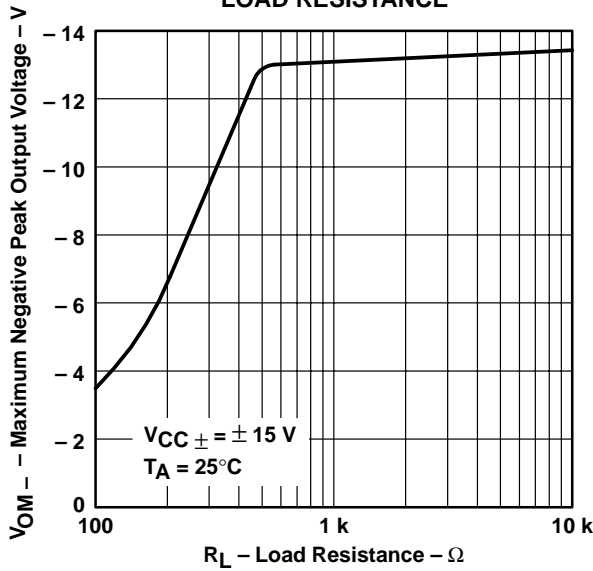
**Figure 14**

**MAXIMUM POSITIVE PEAK  
 OUTPUT VOLTAGE  
 vs  
 LOAD RESISTANCE**



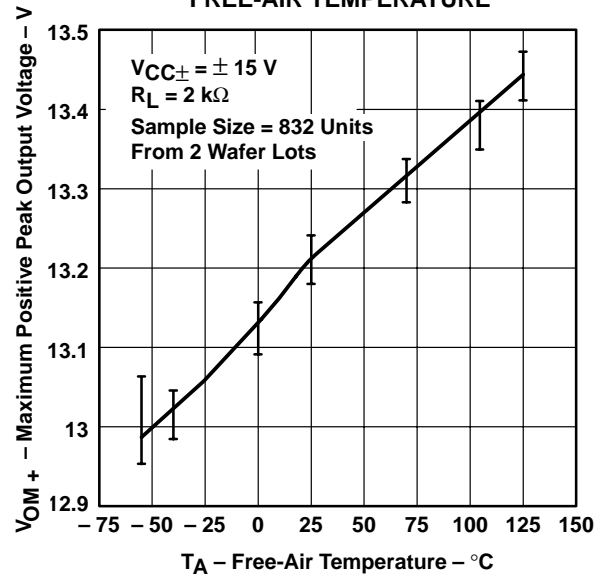
**Figure 15**

**MAXIMUM NEGATIVE PEAK  
 OUTPUT VOLTAGE  
 vs  
 LOAD RESISTANCE**



**Figure 16**

**MAXIMUM POSITIVE PEAK  
 OUTPUT VOLTAGE†  
 vs  
 FREE-AIR TEMPERATURE**



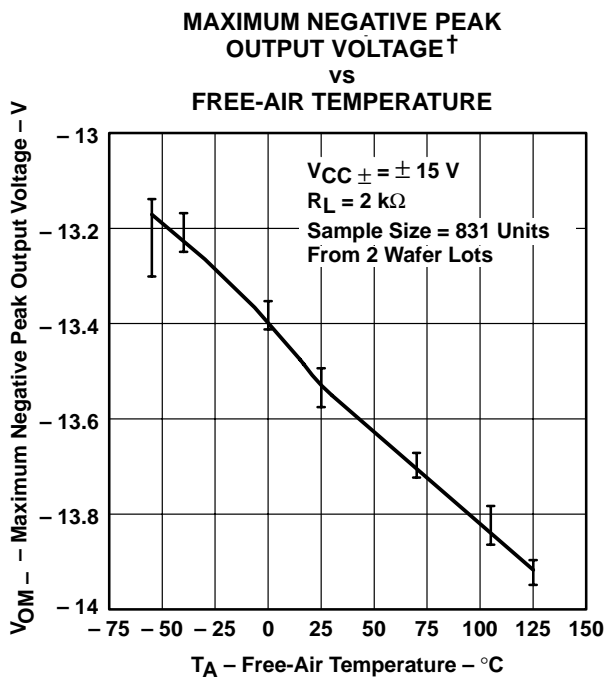
**Figure 17**

† Data at high and low temperatures are applicable only within the rated operating free-air temperature ranges of the various devices.

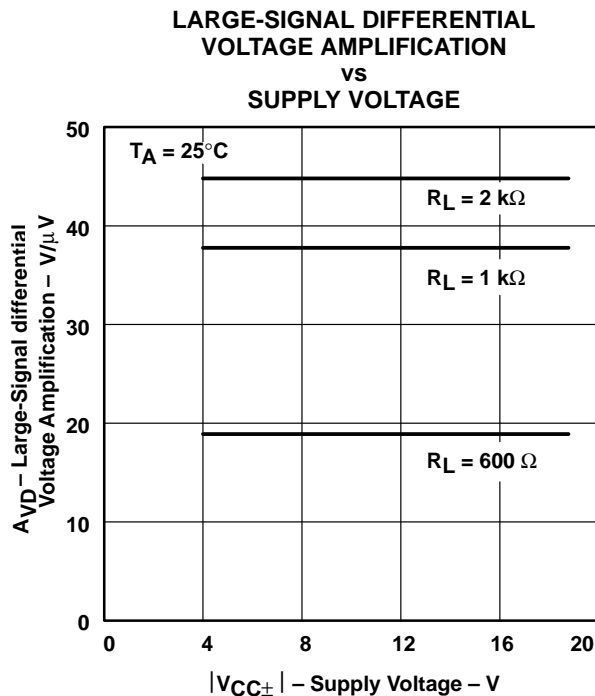
**TLE2027, TLE2037, TLE2027A, TLE2037A, TLE2027Y, TLE2037Y**  
**EXCALIBUR LOW-NOISE HIGH-SPEED**  
**PRECISION OPERATIONAL AMPLIFIERS**

SLOS192A – FEBRUARY 1997 REVISED MARCH 2002

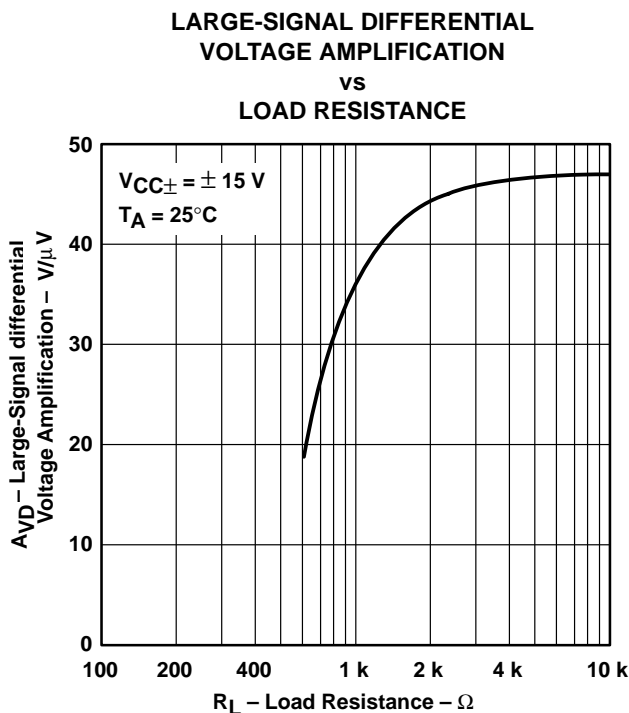
**TYPICAL CHARACTERISTICS**



**Figure 18**



**Figure 19**



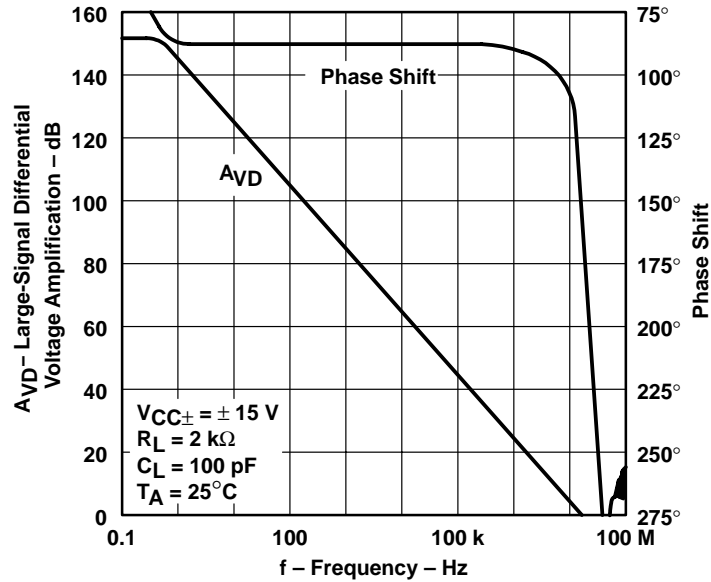
**Figure 20**

† Data at high and low temperatures are applicable only within the rated operating free-air temperature ranges of the various devices.



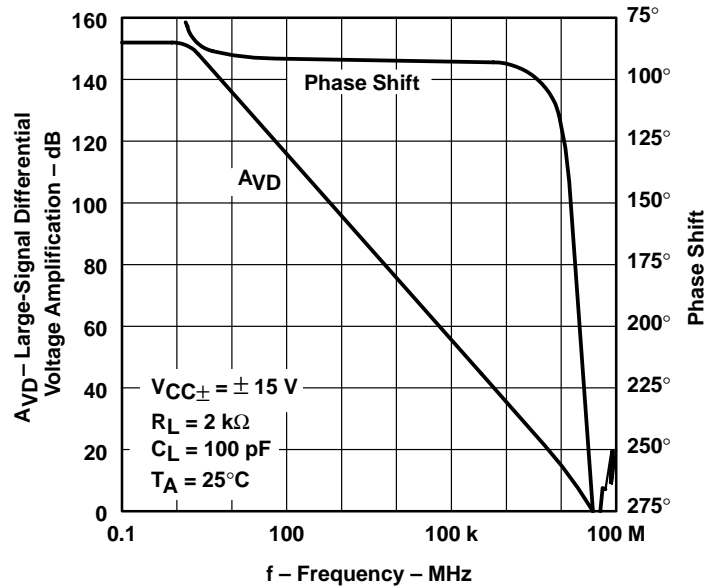
**TYPICAL CHARACTERISTICS**

**TLE2027  
 LARGE-SIGNAL DIFFERENTIAL VOLTAGE  
 AMPLIFICATION AND PHASE SHIFT  
 vs  
 FREQUENCY**



**Figure 21**

**TLE2037  
 LARGE-SIGNAL DIFFERENTIAL VOLTAGE  
 AMPLIFICATION AND PHASE SHIFT  
 vs  
 FREQUENCY**



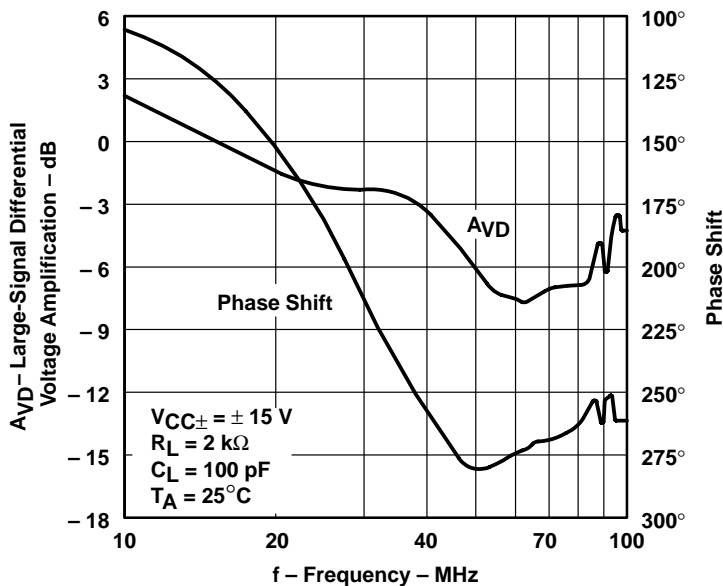
**Figure 22**

**TLE2027, TLE2037, TLE2027A, TLE2037A, TLE2027Y, TLE2037Y**  
**EXCALIBUR LOW-NOISE HIGH-SPEED**  
**PRECISION OPERATIONAL AMPLIFIERS**

SLOS192A – FEBRUARY 1997 REVISED MARCH 2002

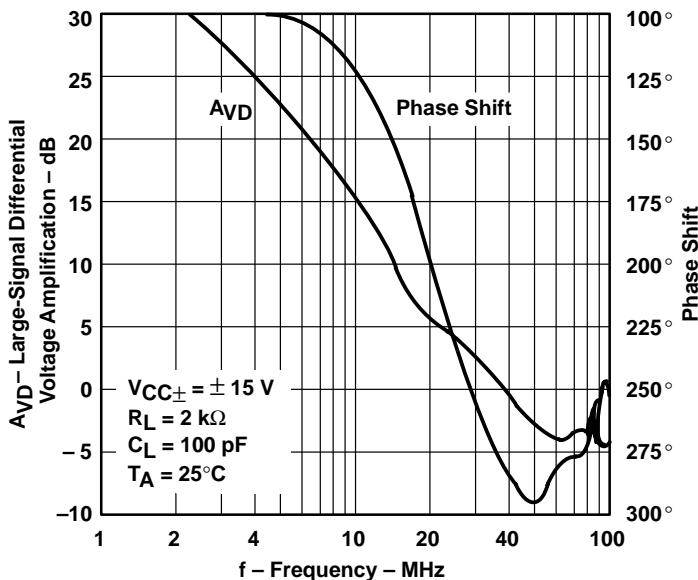
**TYPICAL CHARACTERISTICS**

**TLE2027**  
**LARGE-SIGNAL DIFFERENTIAL VOLTAGE**  
**AMPLIFICATION AND PHASE SHIFT**  
**vs**  
**FREQUENCY**



**Figure 23**

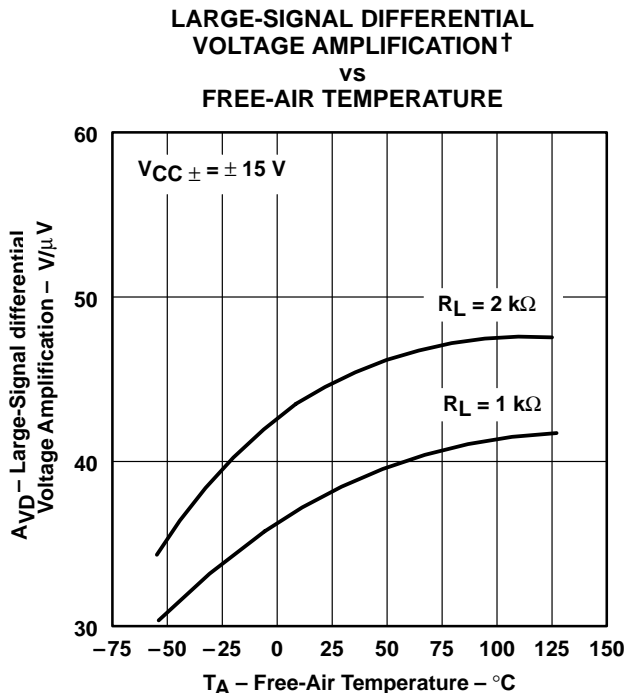
**TLE2037**  
**LARGE-SIGNAL DIFFERENTIAL VOLTAGE**  
**AMPLIFICATION AND PHASE SHIFT**  
**vs**  
**FREQUENCY**



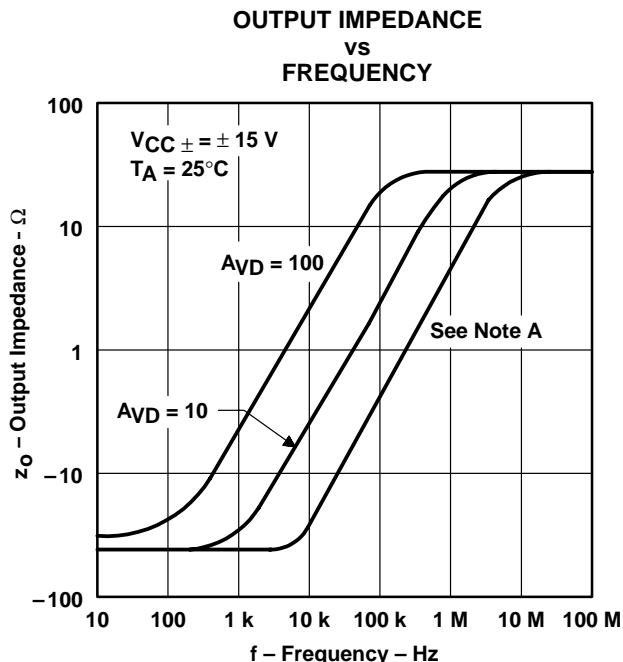
**Figure 24**



**TYPICAL CHARACTERISTICS**

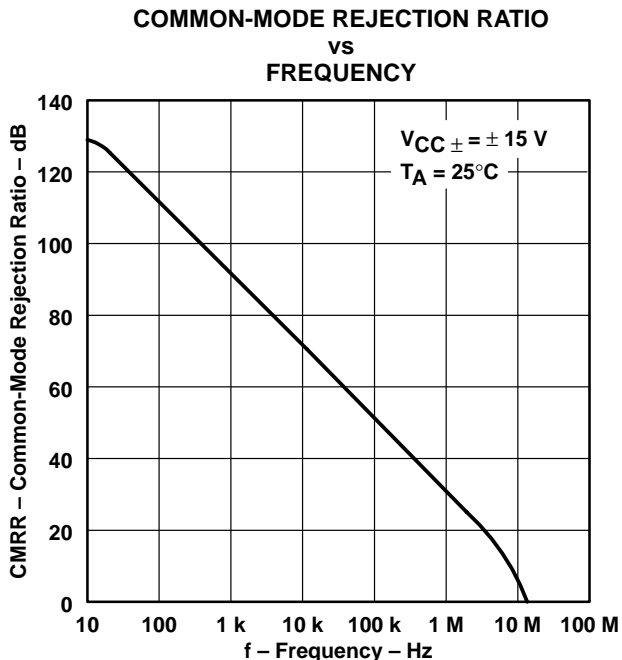


**Figure 25**

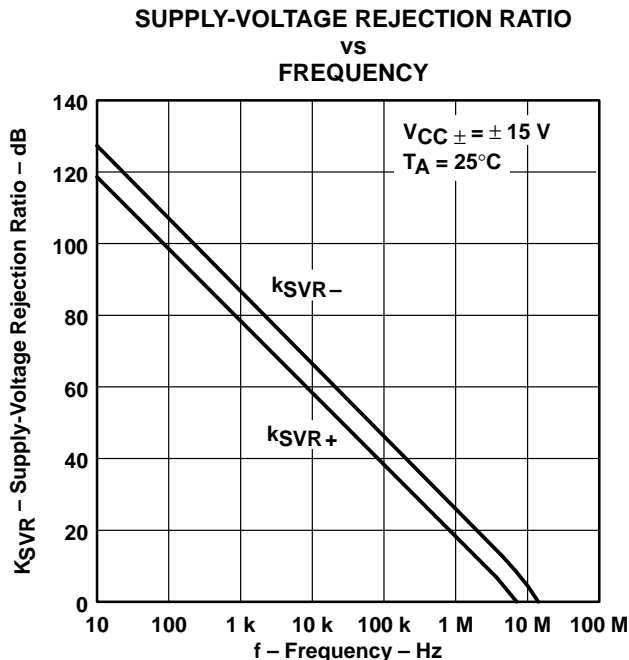


NOTE A: For this curve, the TLE2027 is  $A_{VD} = 1$  and the TLE2037 is  $A_{VD} = 5$ .

**Figure 26**



**Figure 27**

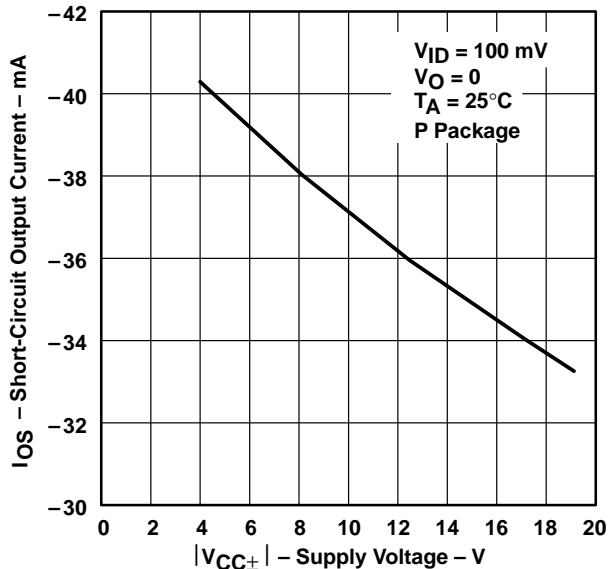


**Figure 28**

† Data at high and low temperatures are applicable only within the rated operating free-air temperature ranges of the various devices.

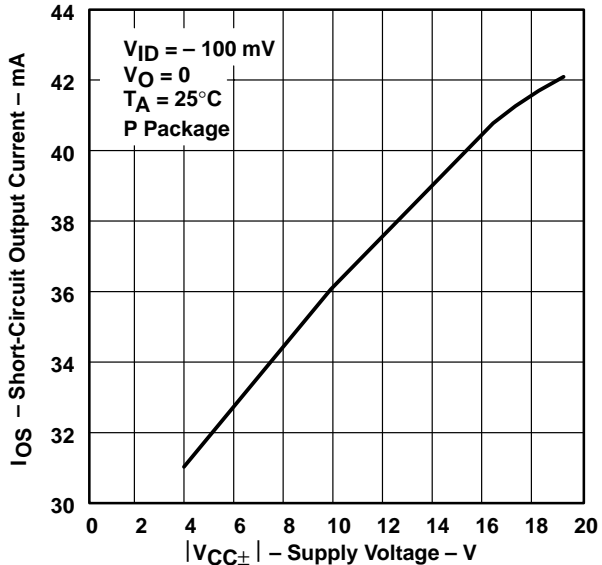
**TYPICAL CHARACTERISTICS**

**SHORT-CIRCUIT OUTPUT CURRENT  
 vs  
 SUPPLY VOLTAGE**



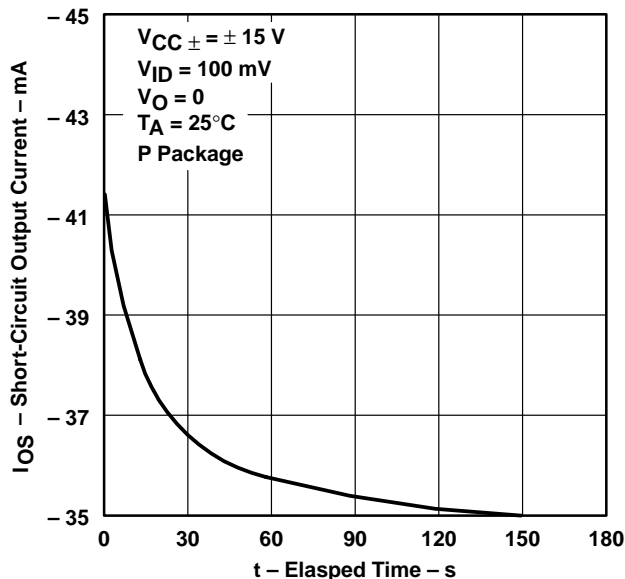
**Figure 29**

**SHORT-CIRCUIT OUTPUT CURRENT  
 vs  
 SUPPLY VOLTAGE**



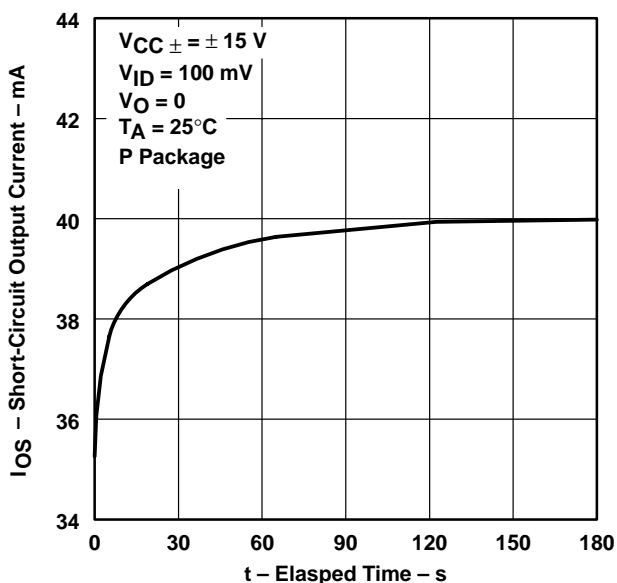
**Figure 30**

**SHORT-CIRCUIT OUTPUT CURRENT  
 vs  
 ELAPSED TIME**



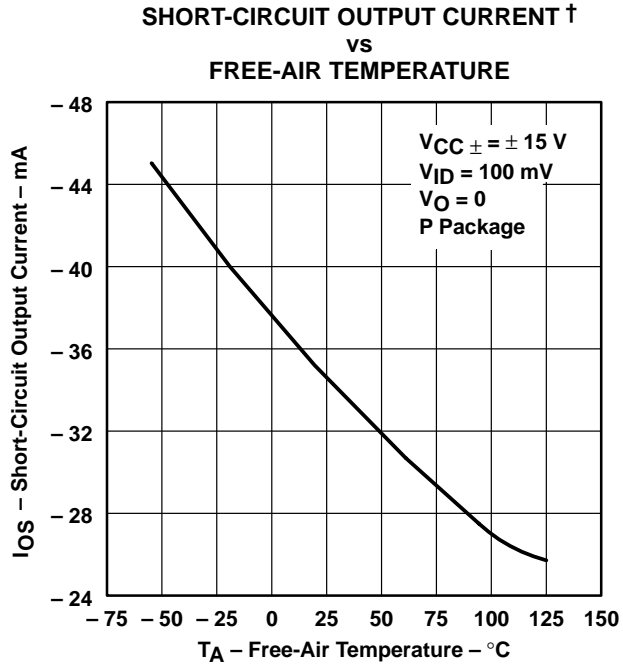
**Figure 31**

**SHORT-CIRCUIT OUTPUT CURRENT  
 vs  
 ELAPSED TIME**

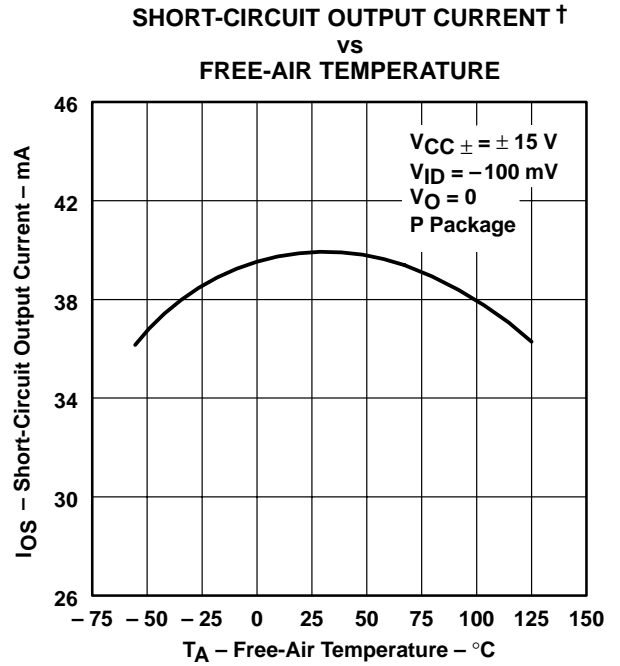


**Figure 32**

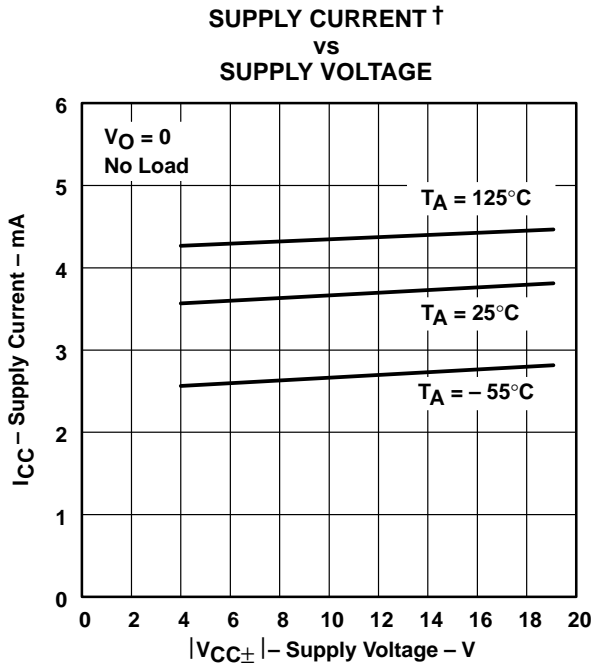
**TYPICAL CHARACTERISTICS**



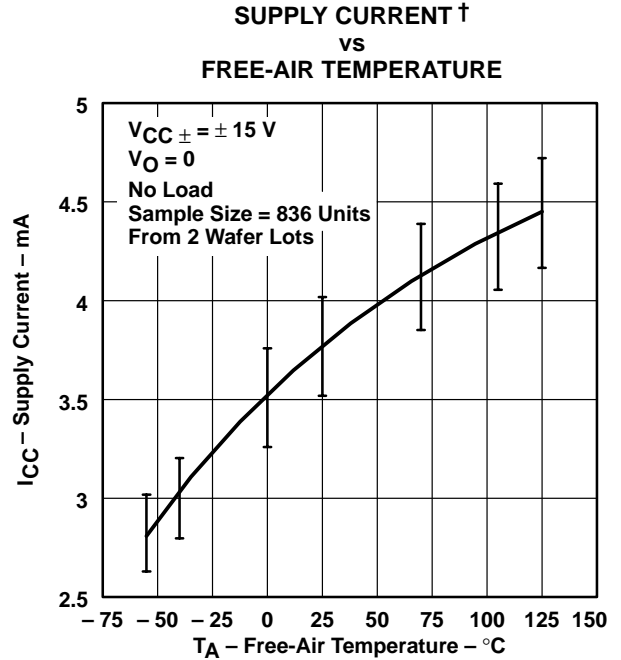
**Figure 33**



**Figure 34**



**Figure 35**



**Figure 36**

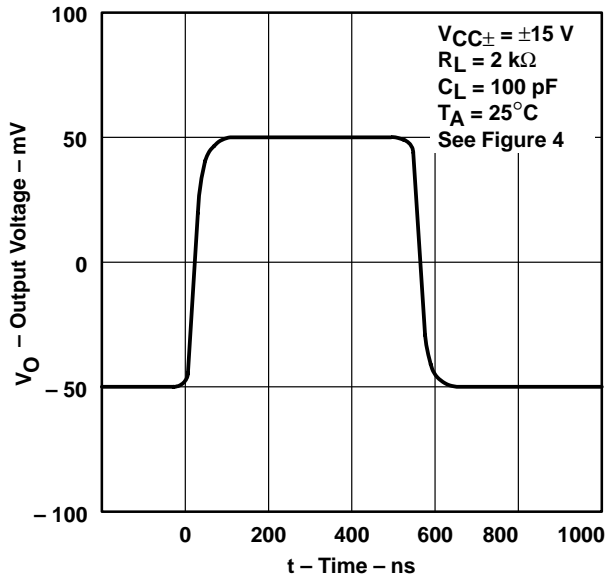
† Data at high and low temperatures are applicable only within the rated operating free-air temperature ranges of the various devices.

**TLE2027, TLE2037, TLE2027A, TLE2037A, TLE2027Y, TLE2037Y**  
**EXCALIBUR LOW-NOISE HIGH-SPEED**  
**PRECISION OPERATIONAL AMPLIFIERS**

SLOS192A – FEBRUARY 1997 REVISED MARCH 2002

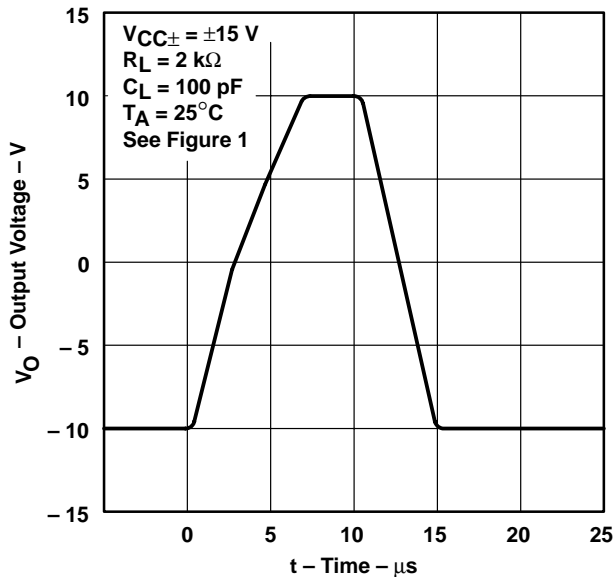
**TYPICAL CHARACTERISTICS**

**TLE2027**  
**VOLTAGE-FOLLOWER**  
**SMALL-SIGNAL**  
**PULSE RESPONSE**



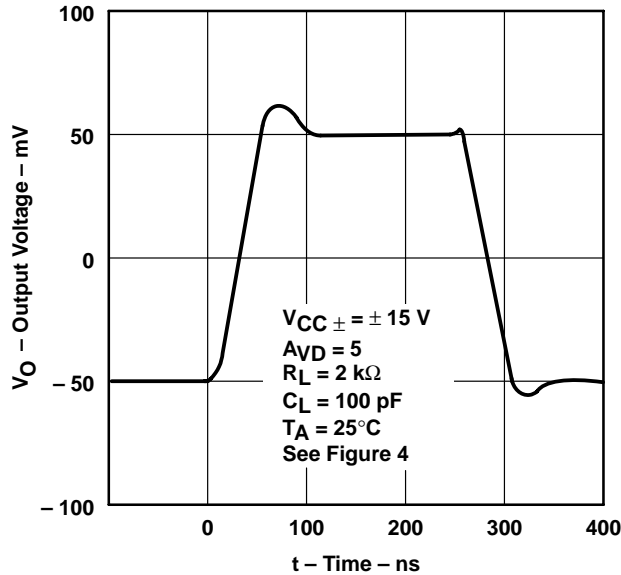
**Figure 37**

**TLE2027**  
**VOLTAGE-FOLLOWER**  
**LARGE-SIGNAL**  
**PULSE RESPONSE**



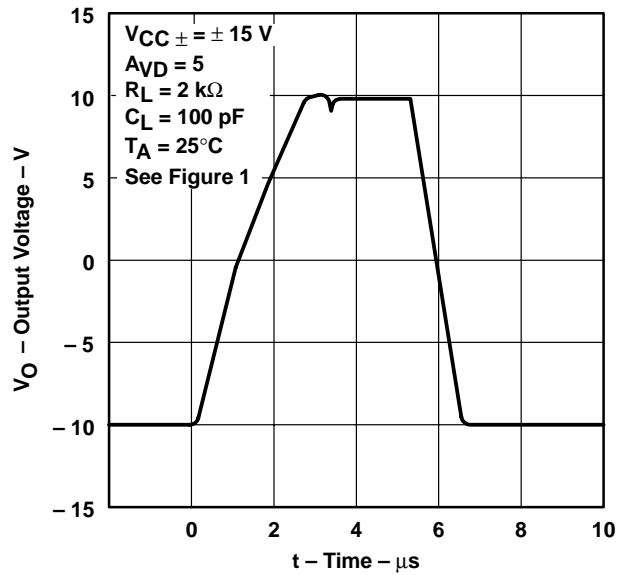
**Figure 38**

**TLE2037**  
**VOLTAGE-FOLLOWER**  
**SMALL-SIGNAL**  
**PULSE RESPONSE**



**Figure 39**

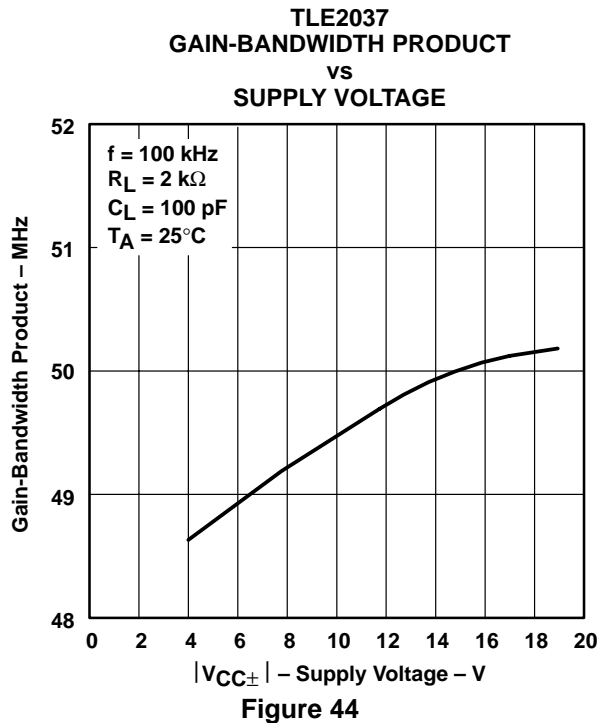
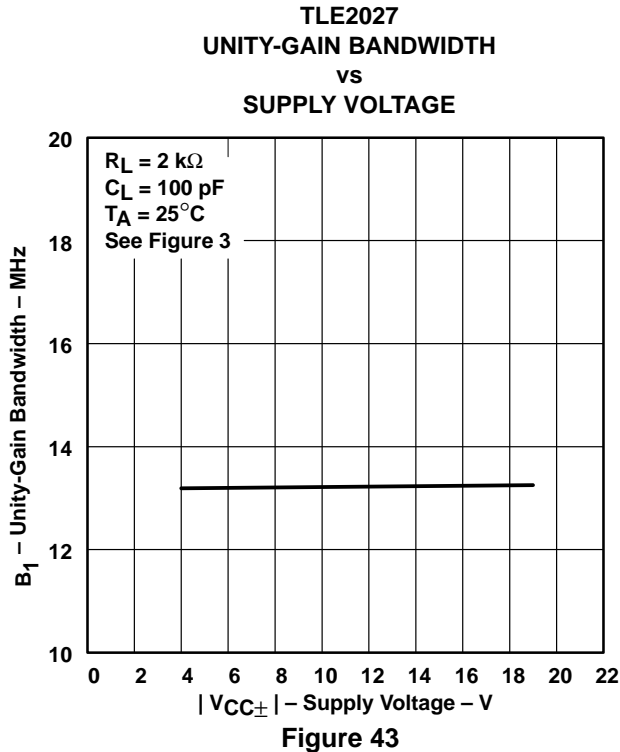
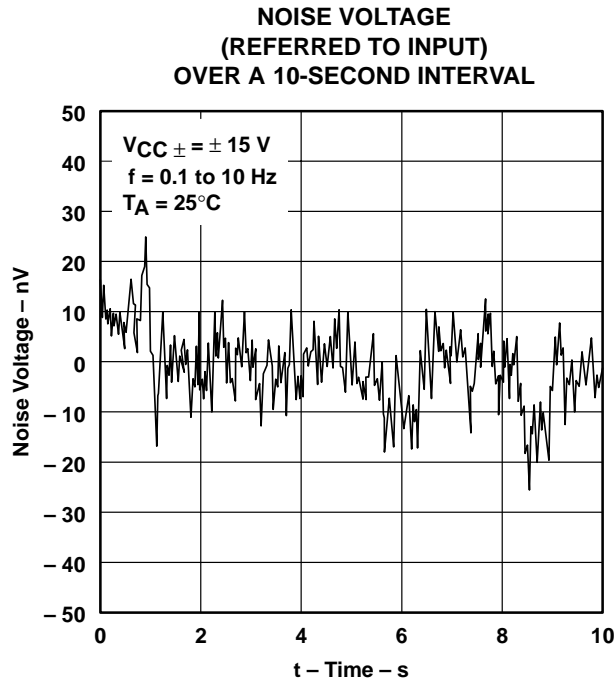
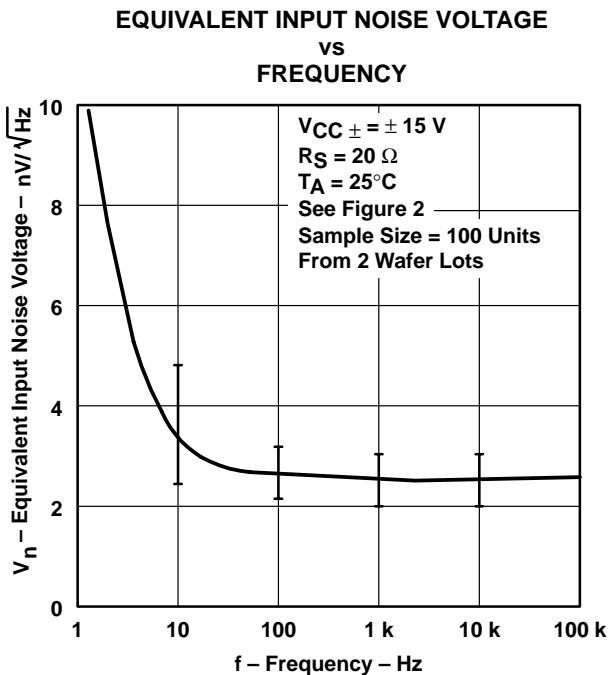
**TLE2037**  
**VOLTAGE-FOLLOWER**  
**LARGE-SIGNAL**  
**PULSE RESPONSE**



**Figure 40**



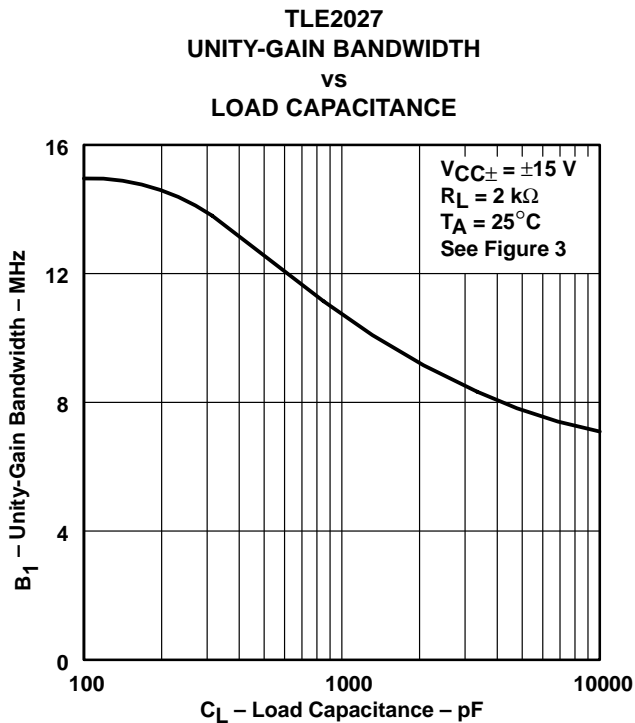
**TYPICAL CHARACTERISTICS**



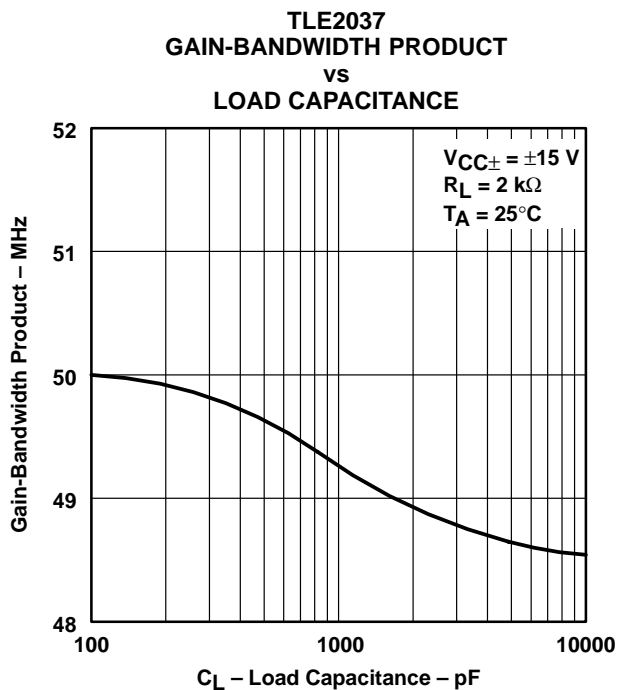
**TLE2027, TLE2037, TLE2027A, TLE2037A, TLE2027Y, TLE2037Y**  
**EXCALIBUR LOW-NOISE HIGH-SPEED**  
**PRECISION OPERATIONAL AMPLIFIERS**

SLOS192A – FEBRUARY 1997 REVISED MARCH 2002

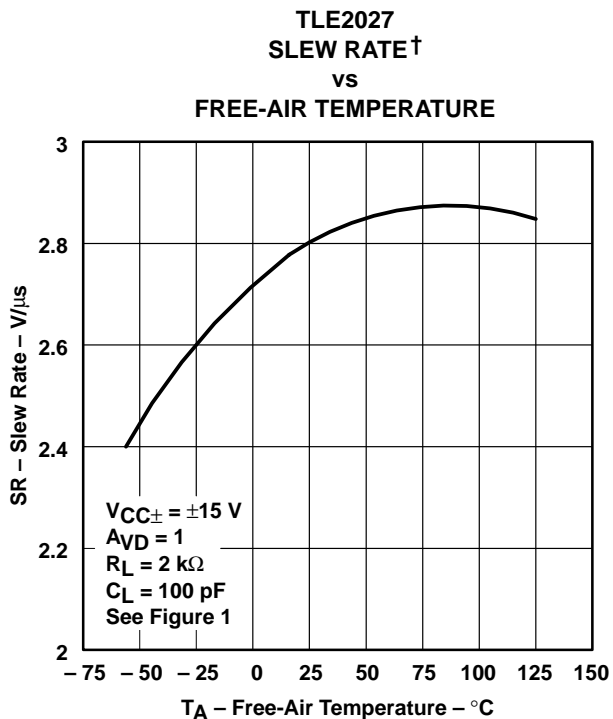
**TYPICAL CHARACTERISTICS**



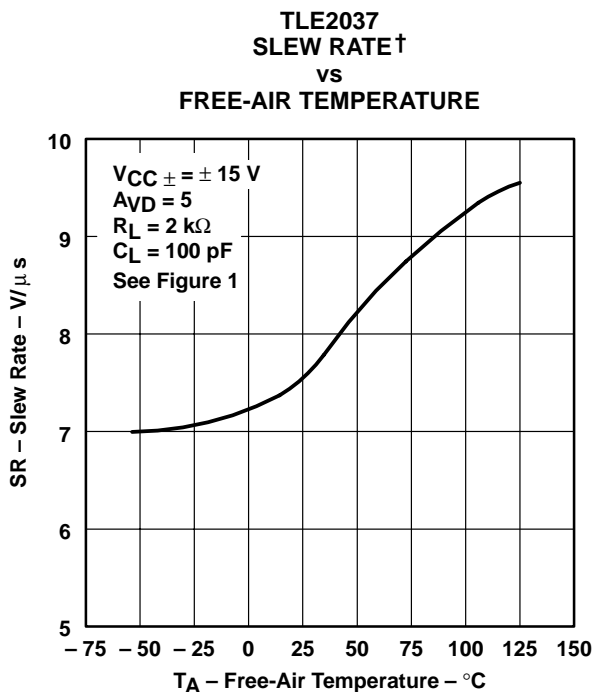
**Figure 45**



**Figure 46**



**Figure 47**



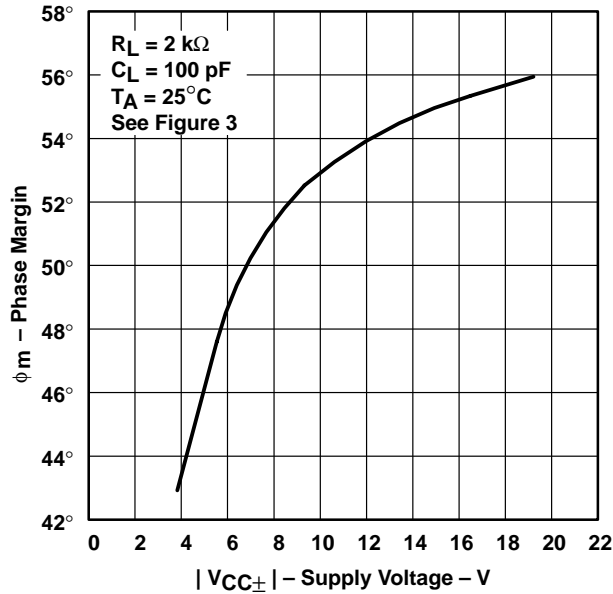
**Figure 48**

† Data at high and low temperatures are applicable only within the rated operating free-air temperature ranges of the various devices.



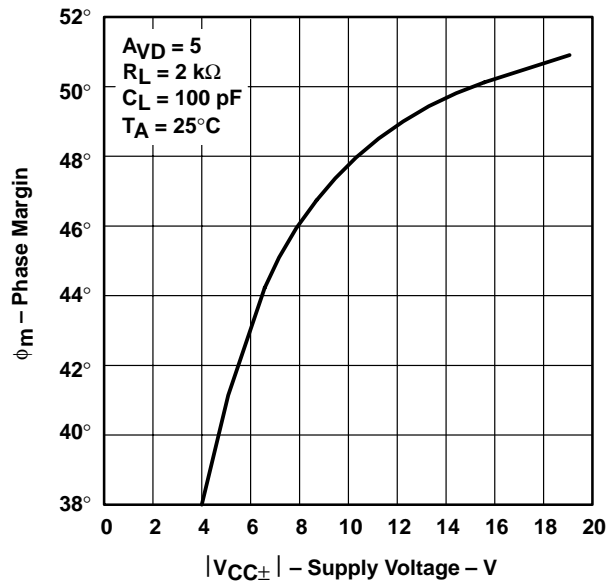
**TYPICAL CHARACTERISTICS**

**TLE2027  
 PHASE MARGIN  
 vs  
 SUPPLY VOLTAGE**



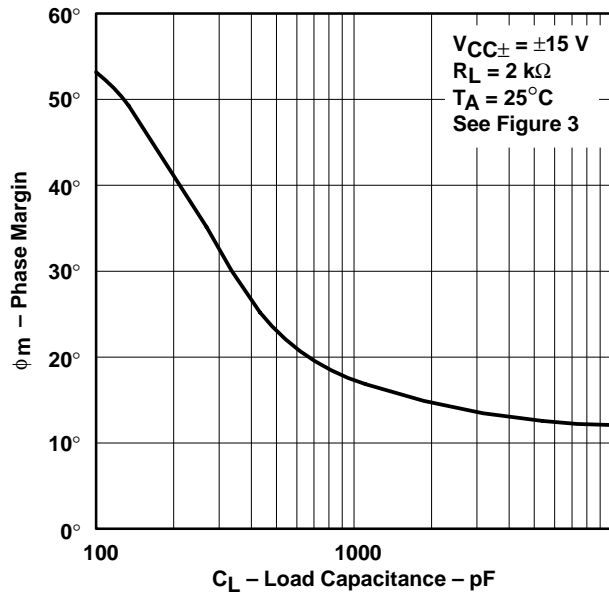
**Figure 49**

**TLE2037  
 PHASE MARGIN  
 vs  
 SUPPLY VOLTAGE**



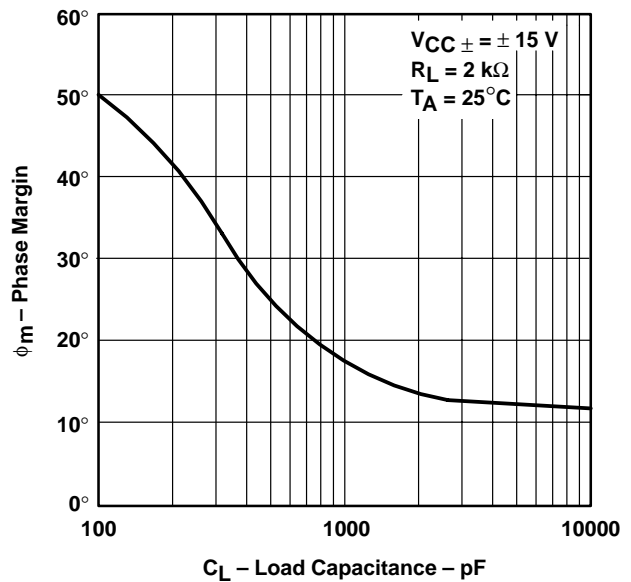
**Figure 50**

**TLE2027  
 PHASE MARGIN  
 vs  
 LOAD CAPACITANCE**



**Figure 51**

**TLE2037  
 PHASE MARGIN  
 vs  
 LOAD CAPACITANCE**



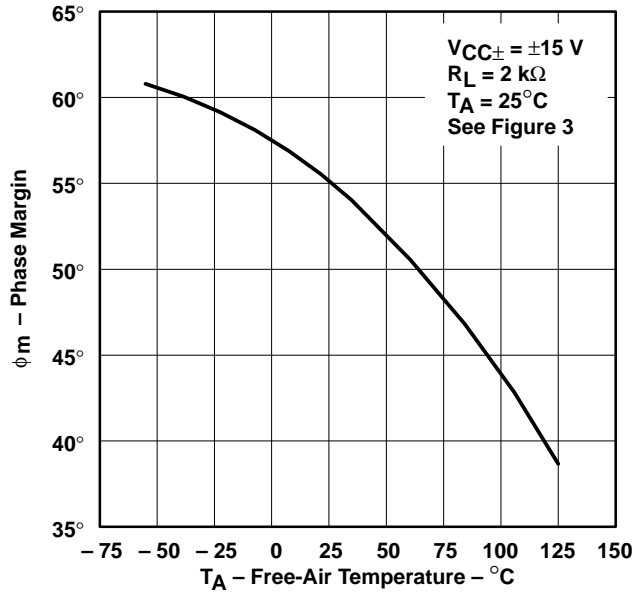
**Figure 52**

**TLE2027, TLE2037, TLE2027A, TLE2037A, TLE2027Y, TLE2037Y**  
**EXCALIBUR LOW-NOISE HIGH-SPEED**  
**PRECISION OPERATIONAL AMPLIFIERS**

SLOS192A – FEBRUARY 1997 REVISED MARCH 2002

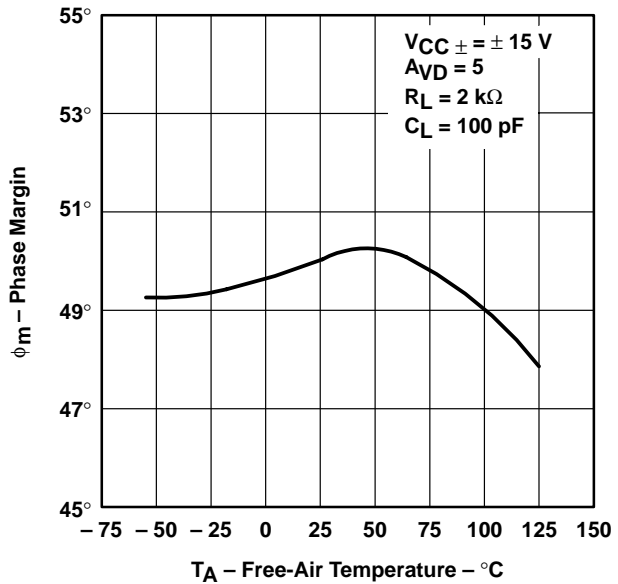
**TYPICAL CHARACTERISTICS**

**TLE2027**  
**PHASE MARGIN†**  
**vs**  
**FREE-AIR TEMPERATURE**



**Figure 53**

**TLE2037**  
**PHASE MARGIN†**  
**vs**  
**FREE-AIR TEMPERATURE**



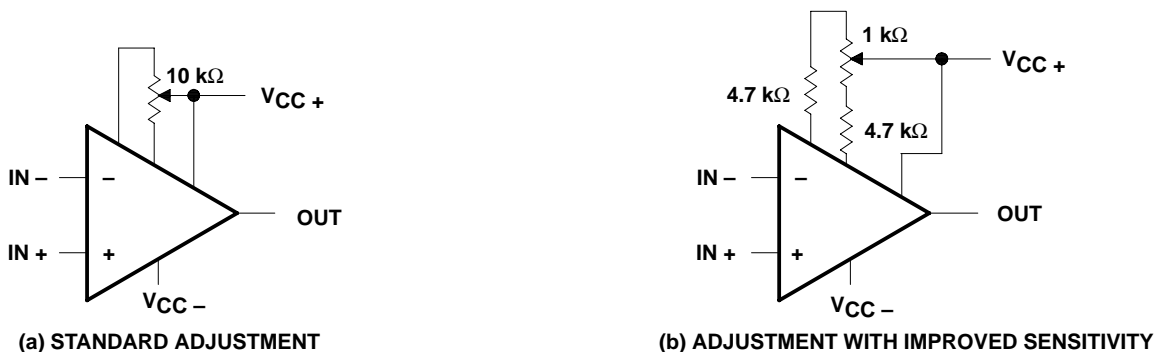
**Figure 54**

† Data at high and low temperatures are applicable only within the rated operating free-air temperature ranges of the various devices.

**APPLICATION INFORMATION**

**input offset voltage nulling**

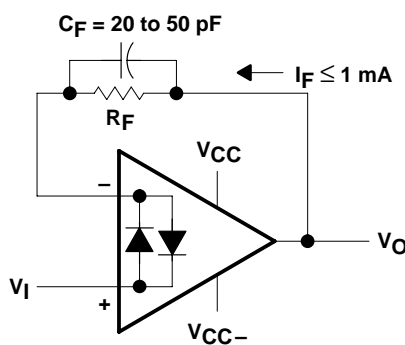
The TLE2027 and TLE2037 series offers external null pins that can be used to further reduce the input offset voltage. The circuits of Figure 55 can be connected as shown if the feature is desired. If external nulling is not needed, the null pins may be left disconnected.



**Figure 55. Input Offset Voltage Nulling Circuits**

**voltage-follower applications**

The TLE2027 circuitry includes input-protection diodes to limit the voltage across the input transistors; however, no provision is made in the circuit to limit the current if these diodes are forward biased. This condition can occur when the device is operated in the voltage-follower configuration and driven with a fast, large-signal pulse. It is recommended that a feedback resistor be used to limit the current to a maximum of 1 mA to prevent degradation of the device. Also, this feedback resistor forms a pole with the input capacitance of the device. For feedback resistor values greater than 10 kΩ, this pole degrades the amplifier phase margin. This problem can be alleviated by adding a capacitor (20 pF to 50 pF) in parallel with the feedback resistor (see Figure 56).



**Figure 56. Voltage Follower**

# TLE2027, TLE2037, TLE2027A, TLE2037A, TLE2027Y, TLE2037Y EXCALIBUR LOW-NOISE HIGH-SPEED PRECISION OPERATIONAL AMPLIFIERS

SLOS192A – FEBRUARY 1997 REVISED MARCH 2002

## APPLICATION INFORMATION

### macromodel information

Macromodel information provided was derived using Microsim *Parts*™, the model generation software used with Microsim *PSpice*™. The Boyle macromodel (see Note 6) and subcircuit in Figure 57, Figure 58, and Figure 59 were generated using the TLE20x7 typical electrical and operating characteristics at 25°C. Using this information, output simulations of the following key parameters can be generated to a tolerance of 20% (in most cases):

- Maximum positive output voltage swing
- Maximum negative output voltage swing
- Slew rate
- Quiescent power dissipation
- Input bias current
- Open-loop voltage amplification
- Gain-bandwidth product
- Common-mode rejection ratio
- Phase margin
- DC output resistance
- AC output resistance
- Short-circuit output current limit

NOTE 6: G. R. Boyle, B. M. Cohn, D. O. Pederson, and J. E. Solomon, "Macromodeling of Integrated Circuit Operational Amplifiers", IEEE Journal of Solid-State Circuits, SC-9, 353 (1974).

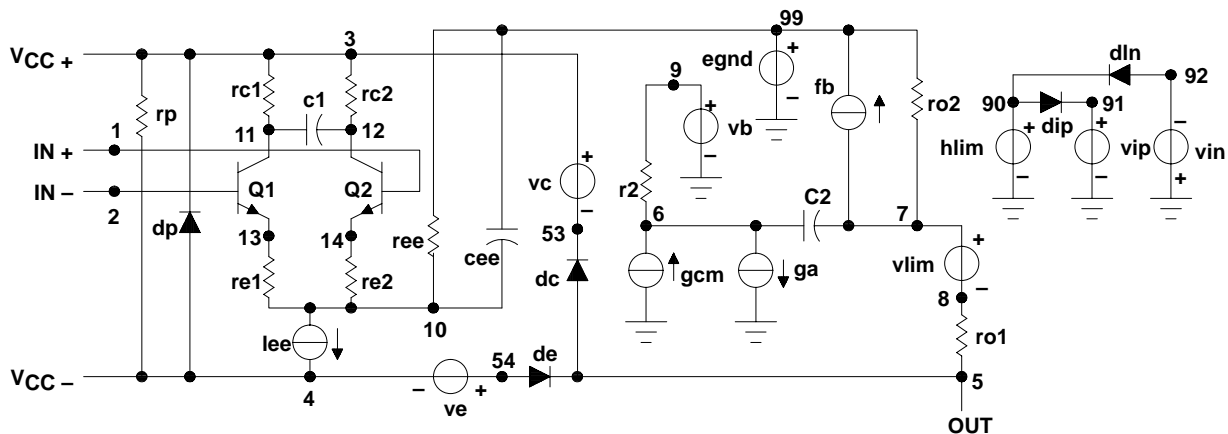


Figure 57. Boyle Macromodel

*PSpice* and *Parts* are trademarks of MicroSim Corporation.



POST OFFICE BOX 655303 • DALLAS, TEXAS 75265

**APPLICATION INFORMATION**

**macromodel information (continued)**

```
.subckt TLE2027 1 2 3 4 5
*
c1      11  12  4.003E-12
c2      6   7   20.00E-12
dc      5  53  dz
de      54  5   dz
dlp     90  91  dz
dln     92  90  dx
dp      4   3   dz
egnd    99   0  poly(2) (3,0)
(4,0) 0 5 .5
fb      7   99  poly(5) vb vc
ve vlp vln 0 954.8E6 -1E9 1E9 1E9
-1E9
ga      6   0  11  12
2.062E-3
gcm     0   6  10  99
531.3E-12
iee     10  4   dc 56.01E-6
hlim    90  0   vlim 1K
ql      11  2   13 qx
q2      12  1   14 qx
r2      6   9   100.0E3
rc1     3  11  530.5
rc2     3  12  530.5
re1     13  10 -393.2
re2     14  10 -393.2
ree     10  99 3.571E6
ro1     8   5   25
ro2     7  99  25
rp      3   4   8.013E3
vb      9   0   dc 0
vc      3  53  dc 2.400
ve      54  4   dc 2.100
vlim    7   8   dc 0
vlp     91  0   dc 40
vln     0  92  dc 40
.modeldx D(Is=800.0E-18)
.modelqx NPN(Is=800.0E-18
Bf=7.000E3)
.ends
```

**Figure 58. TLE2027 Macromodel Subcircuit**

```
.subckt TLE2037 1 2 3 4 5
*
c1      11  12  4.003E-12
c2      6   7   7.500E-12
dc      5  53  dz
de      54  5   dz
dlp     90  91  dz
dln     92  90  dx
dp      4   3   dz
egnd    99   0  poly(2) (3,0)
(4,0) 0 .5 .5
fb      7   99  poly(5) vb vc
ve vip vln 0 923.4E6 A800E6
800E6 800E6 A800E6
ga      6   0  11  12 2.121E-3
gcm     0   6  10  99 597.7E-12
iee     10  4   dc 56.26E-6
hlim    90  0   vlim 1K
ql      11  2   13 qx
q2      12  1   14 qz
r2      6   9   100.0E3
rc1     3  11  471.5
rc2     3  12  471.5
re1     13  10 A448
re2     14  10 A448
ree     10  99 3.555E6
ro1     8   5   25
ro2     7  99  25
rp      3   4   8.013E3
vb      9   0   dc 0
vc      3  53  dc 2.400
ve      54  4   dc 2.100
vlim    7   8   dc 0
vlp     91  0   dc 40
vln     0  92  dc 40
.model  dxD(Is=800.0E-18)
.model  qxNPN(Is=800.0E-18
Bf=7.031E3)
.ends
```

**Figure 59. TLE2037 Macromodel Subcircuit**



## IMPORTANT NOTICE

Texas Instruments Incorporated and its subsidiaries (TI) reserve the right to make corrections, modifications, enhancements, improvements, and other changes to its products and services at any time and to discontinue any product or service without notice. Customers should obtain the latest relevant information before placing orders and should verify that such information is current and complete. All products are sold subject to TI's terms and conditions of sale supplied at the time of order acknowledgment.

TI warrants performance of its hardware products to the specifications applicable at the time of sale in accordance with TI's standard warranty. Testing and other quality control techniques are used to the extent TI deems necessary to support this warranty. Except where mandated by government requirements, testing of all parameters of each product is not necessarily performed.

TI assumes no liability for applications assistance or customer product design. Customers are responsible for their products and applications using TI components. To minimize the risks associated with customer products and applications, customers should provide adequate design and operating safeguards.

TI does not warrant or represent that any license, either express or implied, is granted under any TI patent right, copyright, mask work right, or other TI intellectual property right relating to any combination, machine, or process in which TI products or services are used. Information published by TI regarding third-party products or services does not constitute a license from TI to use such products or services or a warranty or endorsement thereof. Use of such information may require a license from a third party under the patents or other intellectual property of the third party, or a license from TI under the patents or other intellectual property of TI.

Reproduction of information in TI data books or data sheets is permissible only if reproduction is without alteration and is accompanied by all associated warranties, conditions, limitations, and notices. Reproduction of this information with alteration is an unfair and deceptive business practice. TI is not responsible or liable for such altered documentation.

Resale of TI products or services with statements different from or beyond the parameters stated by TI for that product or service voids all express and any implied warranties for the associated TI product or service and is an unfair and deceptive business practice. TI is not responsible or liable for any such statements.

### Mailing Address:

Texas Instruments  
Post Office Box 655303  
Dallas, Texas 75265