

TLE2227, TLE2227Y, TLE2237, TLE2237Y EXCALIBUR LOW-NOISE HIGH-SPEED PRECISION DUAL OPERATIONAL AMPLIFIERS

SLOS184 – FEBRUARY 1997

- Outstanding Combination of DC Precision and AC Performance:

Unity-Gain Bandwidth . . . 15 MHz Typ

V_n . . . 3.3 nV/ $\sqrt{\text{Hz}}$ at $f = 10$ Hz Typ,

2.5 nV/ $\sqrt{\text{Hz}}$ at $f = 1$ kHz Typ

V_{IO} . . . 100 μV Typ

A_{VD} . . . 45 V/ μV Typ With $R_L = 2$ k Ω

38 V/ μV Typ With $R_L = 1$ k Ω

- Available in 16-Pin Small-Outline Wide-Body Package
- Macromodels and Statistical Information Included
- Output Features Saturation Recovery Circuitry

description

The TLE22x7C combines innovative circuit design expertise and high-quality process control techniques to produce a level of ac performance and dc precision previously unavailable in dual operational amplifiers. This device allows upgrades to systems that use lower-precision devices and is manufactured using Texas Instruments state-of-the-art Excalibur process.

In the area of dc precision, the TLE22x7C offers a typical offset voltage of 100 μV , a common-mode rejection ratio of 115 dB (typ), a supply voltage rejection ratio of 120 dB (typ), and a dc gain of 45 V/ μV (typ).

The ac performance is highlighted by a typical unity-gain bandwidth specification of 15 MHz, 55° of phase margin, and noise voltage specifications of 3.3 nV/ $\sqrt{\text{Hz}}$ and 2.5 nV/ $\sqrt{\text{Hz}}$ at frequencies of 10 Hz and 1 kHz, respectively.

The TLE22x7C is available in a wide variety of packages, including the industry standard 16-pin small-outline wide-body version for high-density system applications. This device is characterized for operation from 0°C to 70°C.

P PACKAGE
(TOP VIEW)

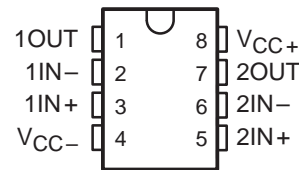

DW PACKAGE
(TOP VIEW)

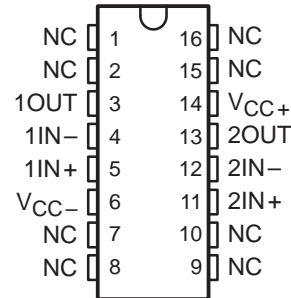

NC – No internal connection

AVAILABLE OPTIONS

T_A	V_{IO} typ AT 25°C	PACKAGED DEVICES		CHIP FORM‡ (Y)
		SMALL OUTLINE† (DW)	PLASTIC DIP (P)	
0°C to 70°C	100 μV	TLE2227CDW	TLE2227CP	TLE2227Y
	100 μV	TLE2237CDW	TLE2237CP	TLE2237Y

† The DW package is available taped and reeled. Add R suffix to device type (e.g., TLE2227CDWR).

‡ Chip forms are tested at 25°C only.



Please be aware that an important notice concerning availability, standard warranty, and use in critical applications of Texas Instruments semiconductor products and disclaimers thereto appears at the end of this data sheet.

PRODUCTION DATA information is current as of publication date. Products conform to specifications per the terms of Texas Instruments standard warranty. Production processing does not necessarily include testing of all parameters.

 **TEXAS
INSTRUMENTS**

POST OFFICE BOX 655303 • DALLAS, TEXAS 75265

Copyright © 1997, Texas Instruments Incorporated

TLE2227, TLE2227Y, TLE2237, TLE2237Y EXCALIBUR LOW-NOISE HIGH-SPEED PRECISION DUAL OPERATIONAL AMPLIFIERS

SLOS184 – FEBRUARY 1997

symbol (each amplifier)

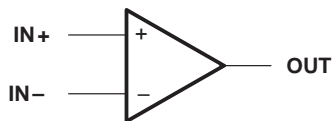

TLE2227Y chip information

This chip, properly assembled, displays characteristics similar to the TLE2227C. Thermal compression or ultrasonic bonding may be used on the doped-aluminum bonding pads. Chips may be mounted with conductive epoxy or a gold-silicon preform.

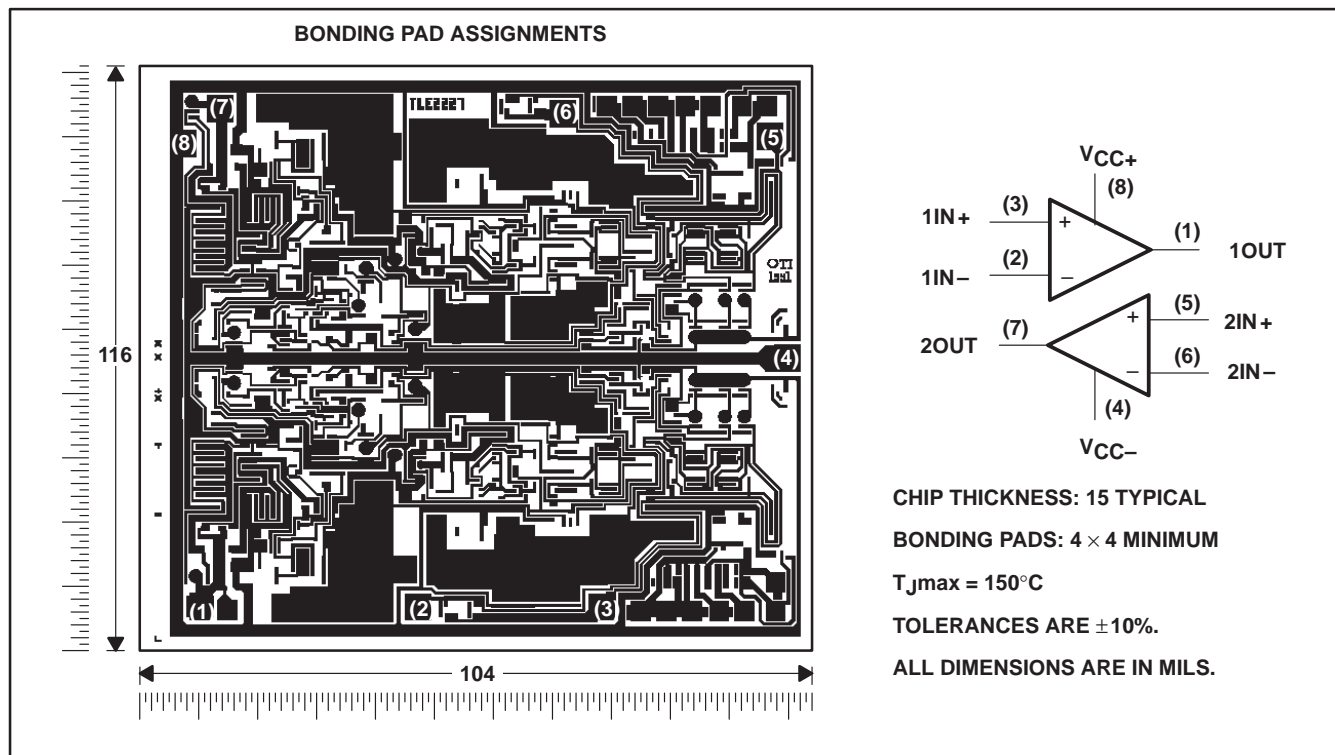

TLE2227, TLE2227Y, TLE2237, TLE2237Y
 EXCALIBUR LOW-NOISE HIGH-SPEED
 PRECISION DUAL OPERATIONAL AMPLIFIERS

SLOS184 – FEBRUARY 1997

TLE2237Y chip information

This chip, when properly assembled, displays characteristics similar to TLE2237. Thermal compression or ultrasonic bonding may be used on the doped-aluminum bonding pads. The chip may be mounted with conductive epoxy or a gold-silicon preform.

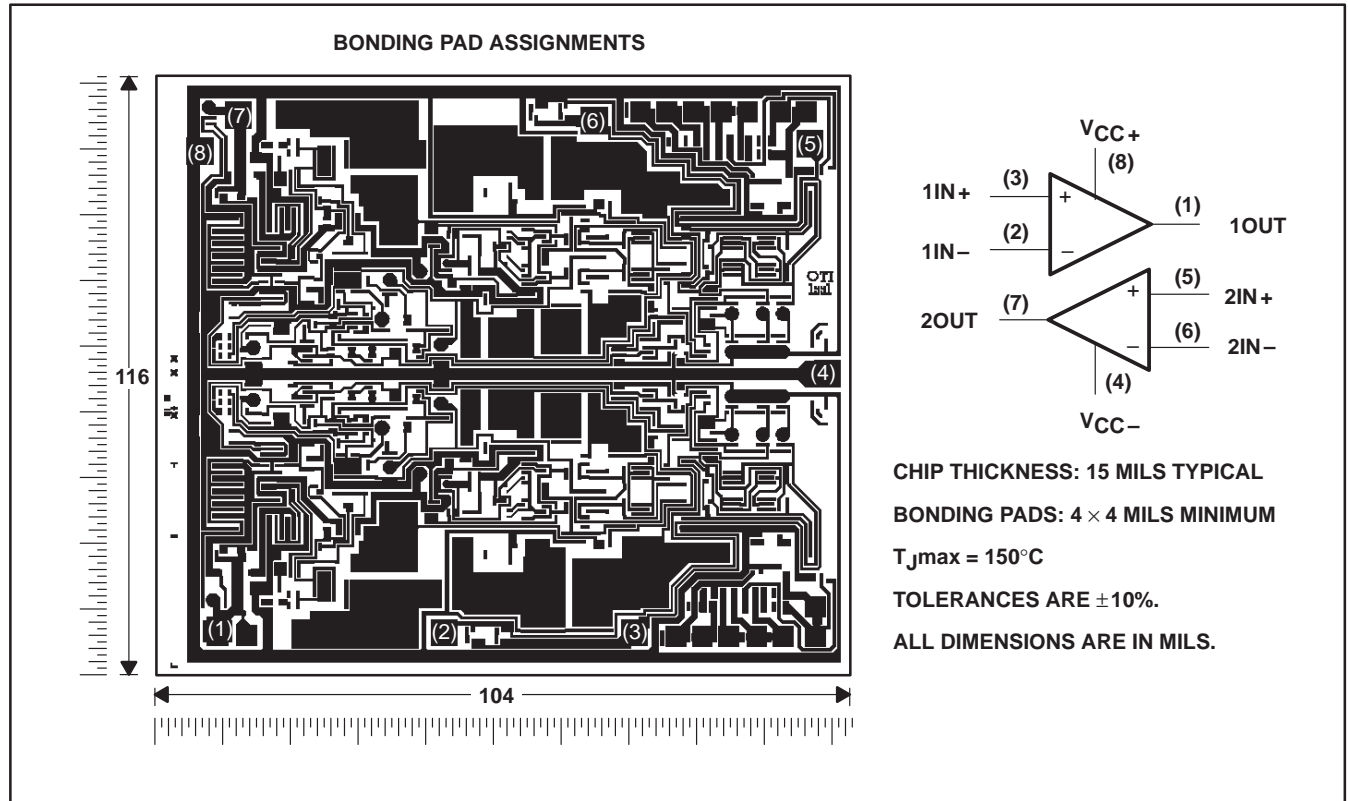

TLE2227, TLE2227Y, TLE2237, TLE2237Y
EXCALIBUR LOW-NOISE HIGH-SPEED
PRECISION DUAL OPERATIONAL AMPLIFIERS
 SLOS184 - FEBRUARY 1997

equivalent schematic (each amplifier)

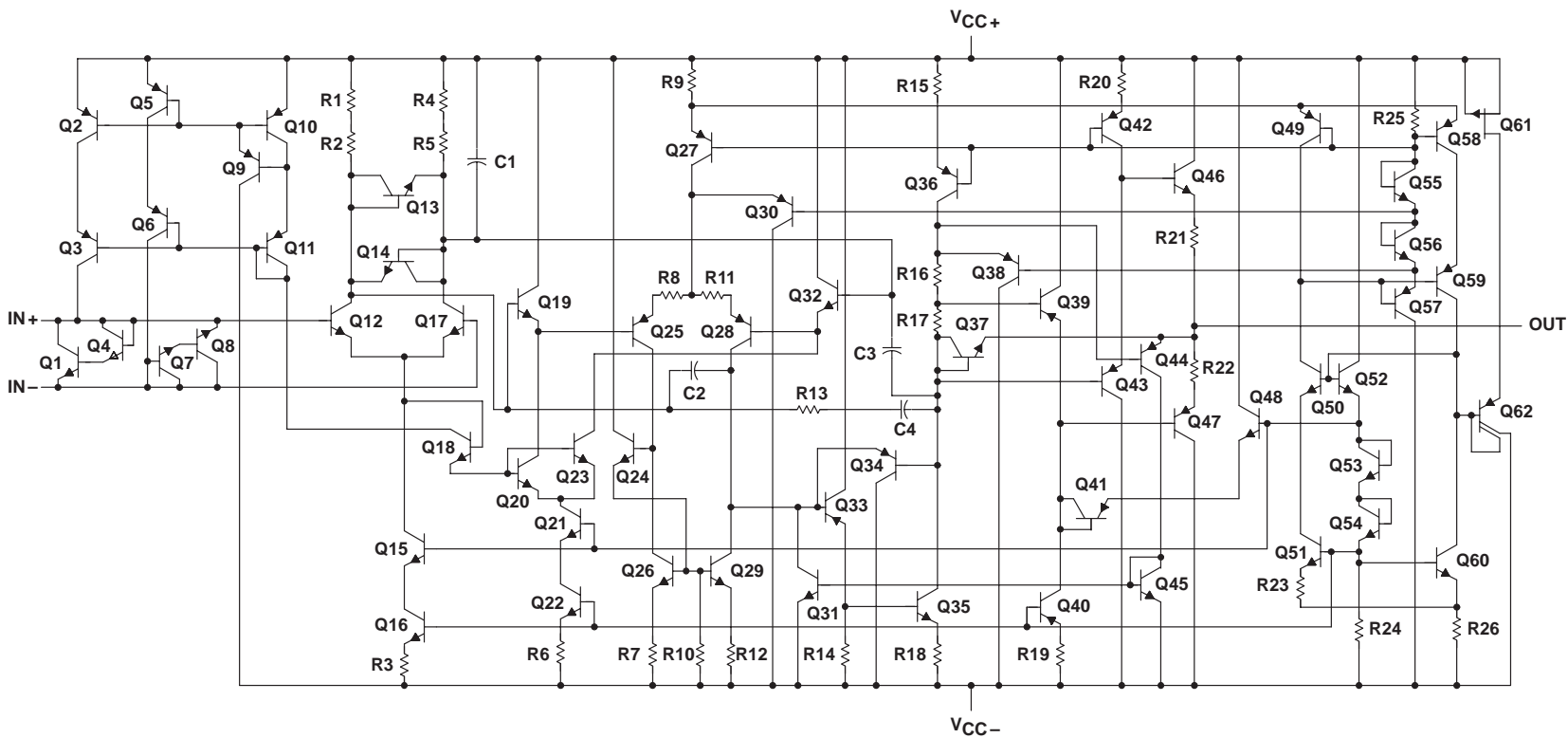

ACTUAL DEVICE COMPONENT COUNT		
COMPONENT	TLE2227	TLE2237
Transistors	62	62
Resistors	24	24
Diodes	0	0
Capacitors	4	4

TLE2227, TLE2227Y, TLE2237, TLE2237Y
EXCALIBUR LOW-NOISE HIGH-SPEED
PRECISION DUAL OPERATIONAL AMPLIFIERS

SLOS184 – FEBRUARY 1997

absolute maximum ratings over operating free-air temperature range (unless otherwise noted)†

Supply voltage, V_{CC+} (see Note 1)	19 V
Supply voltage, V_{CC-}	-19 V
Differential input voltage, V_{ID} (see Note 2)	± 1.2 V
Input voltage range, V_I (any input)	$V_{CC\pm}$
Input current, I_I (each input)	± 1 mA
Output current, I_O	± 50 mA
Total current into V_{CC+}	50 mA
Total current out of V_{CC-}	50 mA
Duration of short-circuit current at (or below) 25°C (see Note 3)	unlimited
Continuous total dissipation	See Dissipation Rating Table
Operating free-air temperature range, T_A	0°C to 70°C
Lead temperature 1,6 mm (1/16 inch) from case for 10 seconds	260°C

† Stresses beyond those listed under “absolute maximum ratings” may cause permanent damage to the device. These are stress ratings only, and functional operation of the device at these or any other conditions beyond those indicated under “recommended operating conditions” is not implied. Exposure to absolute-maximum-rated conditions for extended periods may affect device reliability.

- NOTES:
1. All voltage values, except differential voltages, are with respect to the midpoint between V_{CC+} and V_{CC-} .
 2. Differential voltages are at $IN+$ with respect to $IN-$. Excessive current flows if a differential input voltage in excess of approximately ± 1.2 V is applied between the inputs unless some limiting resistance is used.
 3. The output can be shorted to either supply. Temperature and/or supply voltages must be limited to ensure that the maximum dissipation rating is not exceeded.

DISSIPATION RATING TABLE

PACKAGE	$T_A \leq 25^\circ\text{C}$ POWER RATING	DERATING FACTOR ABOVE $T_A = 25^\circ\text{C}$	$T_A = 70^\circ\text{C}$ POWER RATING
DW	1025 mW	8.2 mW/°C	656 mW
P	1000 mW	8.0 mW/°C	640 mW

recommended operating conditions

	MIN	MAX	UNIT
Supply voltage, $V_{CC\pm}$	± 4	± 19	V
Common-mode input voltage, V_{IC}	$T_A = 25^\circ\text{C}$		V
	$T_A = \text{Full range}^\dagger$		
Operating free-air temperature, T_A	0	70	°C

† Full range is 0°C to 70°C.



TLE2227, TLE2227Y, TLE2237, TLE2237Y
EXCALIBUR LOW-NOISE HIGH-SPEED
PRECISION DUAL OPERATIONAL AMPLIFIERS

SLOS184 – FEBRUARY 1997

electrical characteristics at specified free-air temperature, $V_{CC\pm} = \pm 15\text{ V}$ (unless otherwise noted)

PARAMETER	TEST CONDITIONS	T_A †	TLE2227C			UNIT
			MIN	TYP	MAX	
V_{IO} Input offset voltage	$V_{IC} = 0,$ $R_S = 50\ \Omega$	25°C	100	350	μV	
		Full range	500			
α_{VIO} Temperature coefficient of input offset voltage		Full range	0.4	1	$\mu\text{V}/^\circ\text{C}$	
Input offset voltage long-term drift (see Note 4)		25°C	0.006	1	$\mu\text{V}/\text{mo}$	
I_{IO} Input offset current		25°C	7.5	90	nA	
		Full range	150			
I_{IB} Input bias current	25°C	15	90	nA		
	Full range	150				
V_{ICR} Common-mode input voltage range	$R_S = 50\ \Omega$	25°C	-11 to 11	-13 to 13	V	
		Full range	-10.5 to 10.5			
V_{OM+} Maximum positive peak output voltage swing	$R_L = 1\ \text{k}\Omega$	25°C	10.5		V	
		Full range	10			
	$R_L = 2\ \text{k}\Omega$	25°C	12			
		Full range	11			
V_{OM-} Maximum negative peak output voltage swing	$R_L = 1\ \text{k}\Omega$	25°C	-10.5	-13	V	
		Full range	-10			
	$R_L = 2\ \text{k}\Omega$	25°C	-12	-13.5		
		Full range	-11			
A_{VD} Large-signal differential voltage amplification	$V_O = \pm 11\ \text{V},$ $R_L = 2\ \text{k}\Omega$	25°C	2.5	45	$\text{V}/\mu\text{V}$	
		Full range	2			
	$V_O = \pm 10\ \text{V},$ $R_L = 1\ \text{k}\Omega$	25°C	3.5	38		
		Full range	1			
c_i Input capacitance		25°C	8		pF	
z_o Open-loop output impedance	$I_O = 0$	25°C	50		Ω	
CMRR Common-mode rejection ratio	$V_{IC} = V_{ICRmin},$ $R_S = 50\ \Omega$	25°C	98	115	dB	
		Full range	95			
k_{SVR} Supply-voltage rejection ratio ($\Delta V_{CC\pm}/\Delta V_{IO}$)	$V_{CC\pm} = \pm 4\ \text{V to } \pm 18\ \text{V},$ $R_S = 50\ \Omega$	25°C	94	120	dB	
		Full range	92			
I_{CC} Supply current	$V_O = 0,$ No load	25°C	7.3	10.6	mA	
		Full range	11.2			

† Full range is 0°C to 70°C.

NOTE 4: Typical values are based on the input offset voltage shift observed through 168 hours of operating life test at $T_A = 150^\circ\text{C}$ extrapolated to $T_A = 25^\circ\text{C}$ using the Arrhenius equation and assuming an activation energy of 0.96 eV.



TLE2227, TLE2227Y, TLE2237, TLE2237Y
EXCALIBUR LOW-NOISE HIGH-SPEED
PRECISION DUAL OPERATIONAL AMPLIFIERS

SLOS184 – FEBRUARY 1997

operating characteristics at specified free-air temperature, $V_{CC\pm} = \pm 15\text{ V}$

PARAMETER		TEST CONDITIONS	T_A †	TLE2227C			UNIT
				MIN	TYP	MAX	
SR	Slew rate	$R_L = 2\text{ k}\Omega$, $C_L = 100\text{ pF}$	25°C	1.7	2.5		V/ μ s
			Full range	1.2			
V_n	Equivalent input noise voltage	$R_S = 20\ \Omega$, $f = 10\text{ Hz}$	25°C	3.3		8	nV/ $\sqrt{\text{Hz}}$
		$R_S = 20\ \Omega$, $f = 1\text{ kHz}$		2.5			
$V_{N(PP)}$	Peak-to-peak equivalent input noise voltage	$f = 0.1\text{ Hz to }10\text{ Hz}$	25°C	50	250		nV
I_n	Equivalent input noise current	$f = 10\text{ Hz}$	25°C	1.5		4	pA/ $\sqrt{\text{Hz}}$
		$f = 1\text{ kHz}$		0.4			
THD	Total harmonic distortion	$V_O = \pm 10\text{ V}$, $A_{VD} = 1$, See Note 5	25°C	<0.002%			
B_1	Unity-gain bandwidth	$R_L = 2\text{ k}\Omega$, $C_L = 100\text{ pF}$	25°C	7	13		MHz
B_{OM}	Maximum output-swing bandwidth	$R_L = 2\text{ k}\Omega$	25°C	30			kHz
ϕ_m	Phase margin	$R_L = 2\text{ k}\Omega$, $C_L = 100\text{ pF}$	25°C	40°			

† Full range is 0°C to 70°C.

NOTE 5: Measured distortion of the source used in the analysis is 0.002%.

TLE2227, TLE2227Y, TLE2237, TLE2237Y
EXCALIBUR LOW-NOISE HIGH-SPEED
PRECISION DUAL OPERATIONAL AMPLIFIERS

SLOS184 – FEBRUARY 1997

electrical characteristics at specified free-air temperature, $V_{CC\pm} = \pm 15\text{ V}$ (unless otherwise noted)

PARAMETER	TEST CONDITIONS	T_A^\dagger	TLE2237C			UNIT
			MIN	TYP	MAX	
V_{IO} Input offset voltage	$V_{IC} = 0, R_S = 50\ \Omega$	25°C	100	350		μV
		Full range		500		$\mu\text{V}/^\circ\text{C}$
α_{VIO} Temperature coefficient of input offset voltage		Full range	0.4	1		$\mu\text{V}/\text{mo}$
Input offset voltage long-term drift (see Note 4)		25°C	0.006	1		$\mu\text{V}/\text{mo}$
I_{IO} Input offset current		25°C	7.5	90		nA
		Full range		150		nA
I_{IB} Input bias current	25°C	15	90		nA	
	Full range		150		nA	
V_{ICR} Common-mode input voltage range	$R_S = 50\ \Omega$	25°C	-11 to 11	-13 to 13		V
		Full range	-10.5 to 10.5			V
V_{OM+} Maximum positive peak output voltage swing	$R_L = 1\ \text{k}\Omega$	25°C	10.5			V
		Full range	10			V
	$R_L = 2\ \text{k}\Omega$	25°C	12			V
		Full range	11			V
V_{OM-} Maximum negative peak output voltage swing	$R_L = 1\ \text{k}\Omega$	25°C	-10.5	-13		V
		Full range	-10			V
	$R_L = 2\ \text{k}\Omega$	25°C	-12	-13.5		V
		Full range	-11			V
A_{VD} Large-signal differential voltage amplification	$V_O = \pm 11\text{ V}, R_L = 2\ \text{k}\Omega$	25°C	2.5	45		$\text{V}/\mu\text{V}$
		Full range	2			$\text{V}/\mu\text{V}$
	$V_O = \pm 10\ \text{V}, R_L = 2\ \text{k}\Omega$	25°C	3.5	38		$\text{V}/\mu\text{V}$
		Full range	1			$\text{V}/\mu\text{V}$
C_i Input capacitance		25°C	8		pF	
z_O Open-loop output impedance	$I_O = 0$	25°C	50		Ω	
CMRR Common-mode rejection ratio	$V_{IC} = V_{ICRmin}, R_S = 50\ \Omega$	25°C	98	115		dB
		Full range	95			dB
k_{SVR} Supply-voltage rejection ratio ($\Delta V_{CC\pm}/\Delta V_{IO}$)	$V_{CC\pm} = \pm 4\ \text{V to } \pm 18\ \text{V}, R_S = 50\ \Omega$	25°C	94	120		dB
		Full range	92			dB
I_{CC} Supply current	$V_O = 0, \text{ No load}$	25°C	7.3	10.6		mA
		Full range		11.2		mA

† Full range is 0°C to 70°C.

NOTE 4. Typical values are based on the input offset voltage shift observed through 168 hours of operating life test at $T_A = 150^\circ\text{C}$ extrapolated to $T_A = 25^\circ\text{C}$ using the Arrhenius equation and assuming an activation energy of 0.96 eV.



TLE2227, TLE2227Y, TLE2237, TLE2237Y
EXCALIBUR LOW-NOISE HIGH-SPEED
PRECISION DUAL OPERATIONAL AMPLIFIERS

SLOS184 – FEBRUARY 1997

operating characteristics at specified free-air temperature, $V_{CC\pm} = \pm 15\text{ V}$

PARAMETER		TEST CONDITIONS	T_A †	TLE2237C			UNIT
				MIN	TYP	MAX	
SR	Slew rate	$A_{VD} = 5$, $R_L = 2\text{ k}\Omega$, $C_L = 100\text{ pF}$	25°C	4	5		V/ μ s
			Full range	3			
V_n	Equivalent input noise voltage	$R_S = 20\ \Omega$, $f = 10\text{ Hz}$	25°C		3.3	8	nV/ $\sqrt{\text{Hz}}$
					2.5	4.5	
$V_{n(PP)}$	Peak-to-peak equivalent input noise voltage	$f = 0.1\text{ Hz to }10\text{ Hz}$	25°C		50	250	nV
I_n	Equivalent input noise current	$f = 10\text{ Hz}$	25°C		1.5	4	pA/ $\sqrt{\text{Hz}}$
					0.4	0.6	
THD	Total harmonic distortion	$V_O = \pm 10\text{ V}$, $A_{VD} = 5\text{ V}$, See Note 5	25°C	<0.002%			
GBP	Gain-bandwidth product	$f = 100\text{ kHz}$, $R_L = 2\text{ k}\Omega$, $C_L = 100\text{ pF}$	25°C	35	50		MHz
B _{OM}	Maximum output-swing bandwidth	$R_L = 2\text{ k}\Omega$	25°C	80			kHz
ϕ_m	Phase margin	$R_L = 2\text{ k}\Omega$, $C_L = 100\text{ pF}$	25°C	40°			

† Full range is 0°C to 70°C.

NOTE 5. Measured distortion of the source used in the analysis was 0.002%.

TLE2227, TLE2227Y, TLE2237, TLE2237Y
EXCALIBUR LOW-NOISE HIGH-SPEED
PRECISION DUAL OPERATIONAL AMPLIFIERS

SLOS184 – FEBRUARY 1997

electrical characteristics, $V_{CC\pm} = \pm 15\text{ V}$, $T_A = 25^\circ\text{C}$ (unless otherwise noted)

PARAMETER	TEST CONDITIONS	TLE2227Y			UNIT
		MIN	TYP	MAX	
V_{IO} Input offset voltage	$V_{IC} = 0$, $R_S = 50\ \Omega$		100	350	μV
Input offset voltage long-term drift (see Note 4)			0.006	1	$\mu\text{V}/\text{mo}$
I_{IO} Input offset current			7.5	90	nA
I_{IB} Input bias current			15	90	nA
V_{ICR} Common-mode input voltage range	$R_S = 50\ \Omega$	-11 to 11	-13 to 13		V
V_{OM+} Maximum positive peak output voltage swing	$R_L = 1\ \text{k}\Omega$ $R_L = 2\ \text{k}\Omega$		10.5 12		V
V_{OM-} Maximum negative peak output voltage swing	$R_L = 1\ \text{k}\Omega$ $R_L = 2\ \text{k}\Omega$	-10.5 -12	-13 -13.5		V
A_{VD} Large-signal differential voltage amplification	$V_O = \pm 11\ \text{V}$, $R_L = 2\ \text{k}\Omega$ $V_O = \pm 10\ \text{V}$, $R_L = 1\ \text{k}\Omega$	2.5 3.5	45 38		$\text{V}/\mu\text{V}$
c_i Input capacitance			8		pF
z_o Open-loop output impedance	$I_O = 0$		50		Ω
CMRR Common-mode rejection ratio	$V_{IC} = V_{ICR\text{min}}$, $R_S = 50\ \Omega$	98	115		dB
k_{SVR} Supply-voltage rejection ratio ($\Delta V_{CC\pm}/\Delta V_{IO}$)	$V_{CC\pm} = \pm 4\ \text{V}$ to $\pm 18\ \text{V}$, $R_S = 50\ \Omega$	94	120		dB
I_{CC} Supply current	$V_O = 0$, No load	7.3	10.6		mA

NOTE 4. Typical values are based on the input offset voltage shift observed through 168 hours of operating life test at $T_A = 150^\circ\text{C}$ extrapolated to $T_A = 25^\circ\text{C}$ using the Arrhenius equation and assuming an activation energy of 0.96 eV.

operating characteristics, $V_{CC\pm} = \pm 15\ \text{V}$, $T_A = 25^\circ\text{C}$

PARAMETER	TEST CONDITIONS	TLE2227Y			UNIT
		MIN	TYP	MAX	
SR Slew rate	$R_L = 2\ \text{k}\Omega$, $C_L = 100\ \text{pF}$	1.7	2.5		$\text{V}/\mu\text{s}$
V_n Equivalent input noise voltage	$R_S = 20\ \Omega$, $f = 10\ \text{Hz}$ $R_S = 20\ \Omega$, $f = 1\ \text{kHz}$		3.3 2.5	8 4.5	$\text{nV}/\sqrt{\text{Hz}}$
$V_{N(PP)}$ Peak-to-peak equivalent input noise voltage	$f = 0.1\ \text{Hz}$ to $10\ \text{Hz}$		50	250	nV
I_n Equivalent input noise current	$f = 10\ \text{Hz}$ $f = 1\ \text{kHz}$		1.5 0.4	4 0.6	$\text{pA}/\sqrt{\text{Hz}}$
THD Total harmonic distortion	$V_O = \pm 10\ \text{V}$, $A_{VD} = 1$, See Note 5		<0.002%		
B_1 Unity-gain bandwidth	$R_L = 2\ \text{k}\Omega$, $C_L = 100\ \text{pF}$	7	13		MHz
B_{OM} Maximum output-swing bandwidth	$R_L = 2\ \text{k}\Omega$		30		kHz
ϕ_m Phase margin	$R_L = 2\ \text{k}\Omega$, $C_L = 100\ \text{pF}$		40°		

NOTE 5 Measured distortion of the source used in the analysis is 0.002%.



TLE2227, TLE2227Y, TLE2237, TLE2237Y
EXCALIBUR LOW-NOISE HIGH-SPEED
PRECISION DUAL OPERATIONAL AMPLIFIERS

SLOS184 – FEBRUARY 1997

electrical characteristics at specified free-air temperature $V_{CC\pm} = \pm 15$ V (unless otherwise noted)

PARAMETER		TEST CONDITIONS	TLE2237Y			UNIT
			MIN	TYP	MAX	
V_{IO}	Input offset voltage	$V_{IC} = 0,$ $R_S = 50 \Omega$		100	350	μ V
	Input offset voltage long-term drift (see Note 4)			0.006	1	μ V/mo
I_{IO}	Input offset current			7.5	90	nA
I_{IB}	Input bias current			15	90	nA
V_{ICR}	Common-mode input voltage range	$R_S = 50 \Omega$	-11 to 11	-13 to 13		V
V_{OM+}	Maximum positive peak output voltage swing	$R_L = 1 \text{ k}\Omega$	10.5			V
		$R_L = 2 \text{ k}\Omega$	12			
V_{OM-}	Maximum negative peak output voltage swing	$R_L = 1 \text{ k}\Omega$	-10.5	-13		V
		$R_L = 2 \text{ k}\Omega$	-12	-13.5		
A_{VD}	Large-signal differential voltage amplification	$V_O = \pm 11 \text{ V},$ $R_L = 2 \text{ k}\Omega$	2.5	45		V/ μ V
		$V_O = \pm 10 \text{ V},$ $R_L = 1 \text{ k}\Omega$	3.5	38		
C_i	Input capacitance		8			pF
z_O	Open-loop output impedance	$I_O = 0$	50			Ω
CMRR	Common-mode rejection ratio	$V_{IC} = V_{ICRmin},$ $R_S = 50 \Omega$	98	115		dB
k_{SVR}	Supply-voltage rejection ratio ($\Delta V_{CC\pm}/\Delta V_{IO}$)	$V_{CC\pm} = \pm 4 \text{ V to } \pm 18 \text{ V},$ $R_S = 50 \Omega$	94	120		dB
I_{CC}	Supply current	$V_O = 0,$ No load	7.3	10.6		mA

NOTE 4. Typical values are based on the input offset voltage shift observed through 168 hours of operating life test at $T_A = 150^\circ\text{C}$ extrapolated to $T_A = 25^\circ\text{C}$ using the Arrhenius equation and assuming an activation energy of 0.96 eV.

operating characteristics at specified free-air temperature $V_{CC\pm} = \pm 15$ V

PARAMETER		TEST CONDITIONS	TLE2237Y			UNIT
			MIN	TYP	MAX	
SR	Slew rate	$R_L = 2 \text{ k}\Omega,$ $C_L = 100 \text{ pF}$	4	5		V/ μ s
V_n	Equivalent input noise voltage	$R_S = 20 \Omega,$ $f = 10 \text{ Hz}$		3.3	8	nV/ $\sqrt{\text{Hz}}$
		$R_S = 20 \Omega,$ $f = 1 \text{ kHz}$		2.5	4.5	
$V_{n(PP)}$	Peak-to-peak equivalent input noise voltage	$f = 0.1 \text{ Hz to } 10 \text{ Hz}$		50	250	nV
I_n	Equivalent input noise current	$f = 10 \text{ Hz}$		1.5	4	pA/ $\sqrt{\text{Hz}}$
		$f = 1 \text{ kHz}$		0.4	0.6	
THD	Total harmonic distortion	$V_O = \pm 10 \text{ V},$ $A_{VD} = 1,$ See Note 5	<0.002%			
B_1	Unity-gain bandwidth	$R_L = 2 \text{ k}\Omega,$ $C_L = 100 \text{ pF}$	35	50		MHz
B_{OM}	Maximum output-swing bandwidth	$R_L = 2 \text{ k}\Omega$	80			kHz
ϕ_m	Phase margin	$R_L = 2 \text{ k}\Omega,$ $C_L = 100 \text{ pF}$	40°			

NOTE 5. Measured distortion of the source used in the analysis is 0.002%.



PARAMETER MEASUREMENT INFORMATION

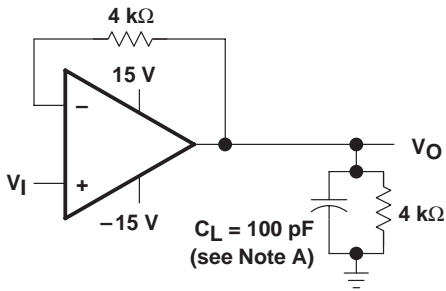

NOTE A: C_L includes fixture capacitance.

Figure 1. Slew-Rate Test Circuit

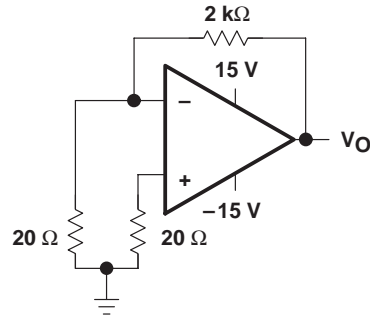
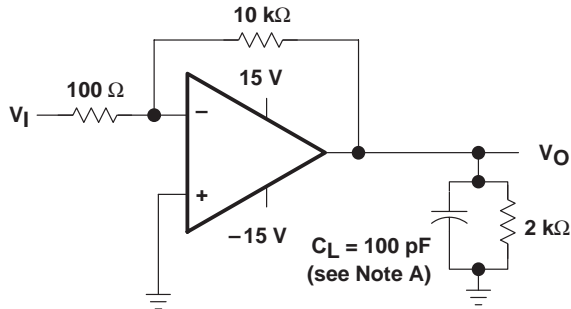
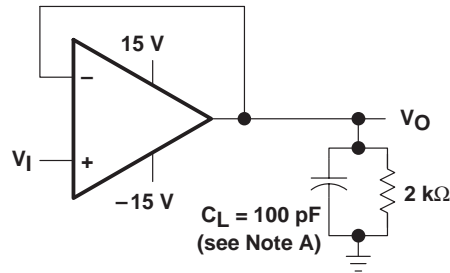

Figure 2. Noise-Voltage Test Circuit



NOTE A: C_L includes fixture capacitance.

Figure 3. Unity-Gain Bandwidth and Phase-Margin Test Circuit



NOTE A: C_L includes fixture capacitance.

Figure 4. Small-Signal Pulse-Response Test Circuit

TYPICAL CHARACTERISTICS

Table of Graphs

			FIGURE
V_{IO}	Input offset voltage	Distribution	5
ΔV_{IO}	Input offset voltage change	vs Time after power on	6, 7
I_{IO}	Input offset current	vs Free-air temperature	8
I_{IB}	Input bias current	vs Common-mode input voltage vs Free-air temperature	9 10
I_I	Input current	vs Differential input voltage	11
$V_{O(PP)}$	Maximum peak-to-peak output voltage	vs Frequency	12
V_{OM}	Maximum peak positive output voltage	vs Load resistance vs Free-air temperature	13 15
V_{OM}	Maximum peak negative output voltage	vs Load resistance vs Free-air temperature	14 16
A_{VD}	Large-signal differential voltage amplification	vs Supply voltage vs Load resistance vs Frequency vs Free-air temperature	17 19 18, 20, 21 22
z_o	Output impedance	vs Frequency	23
CMRR	Common-mode rejection ratio	vs Frequency	24
kSVR	Supply-voltage rejection ratio	vs Frequency	25
I_{OS}	Short-circuit output current	vs Supply voltage vs Elapsed time vs Free-air temperature	26, 27 28, 29 30, 31
I_{CC}	Supply current	vs Supply voltage vs Free-air temperature	32 33
	Voltage-follower small-signal pulse response	vs Time	34, 35
	Voltage-follower large-signal pulse response	vs Time	36, 37
V_n	Equivalent input noise voltage	vs Frequency	38
	Noise voltage (referred to input)	Over 10-second interval	39
B_1	Unity-gain bandwidth	vs Supply voltage vs Load capacitance	40, 41 42, 43
SR	Slew rate	vs Free-air temperature	44, 45
ϕ_m	Phase margin	vs Supply voltage vs Load capacitance	46 47, 48
	Phase shift	vs Frequency	18, 20, 21

TYPICAL CHARACTERISTICS

DISTRIBUTION OF
 INPUT OFFSET VOLTAGE

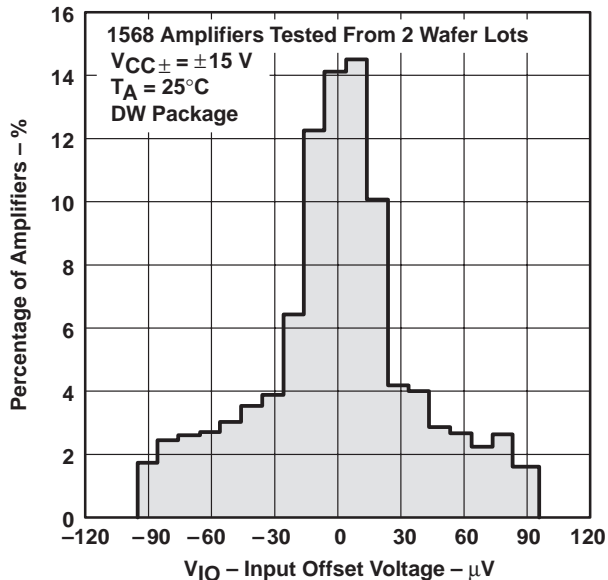

Figure 5

INPUT OFFSET VOLTAGE CHANGE
 vs
 TIME AFTER POWER ON

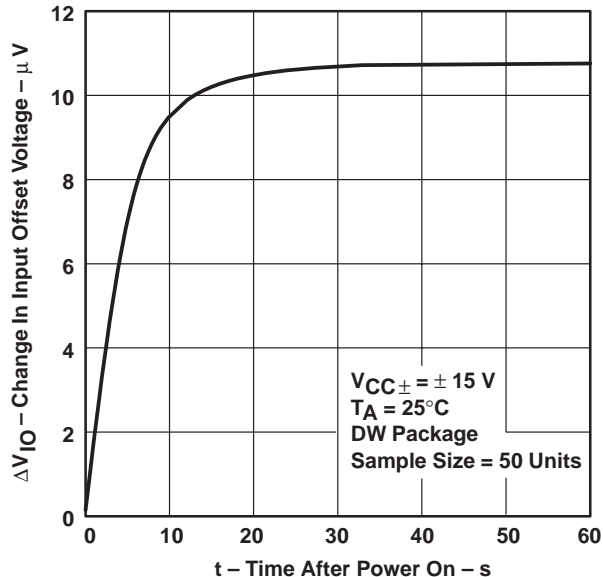

Figure 6

INPUT OFFSET VOLTAGE CHANGE
 vs
 TIME AFTER POWER ON

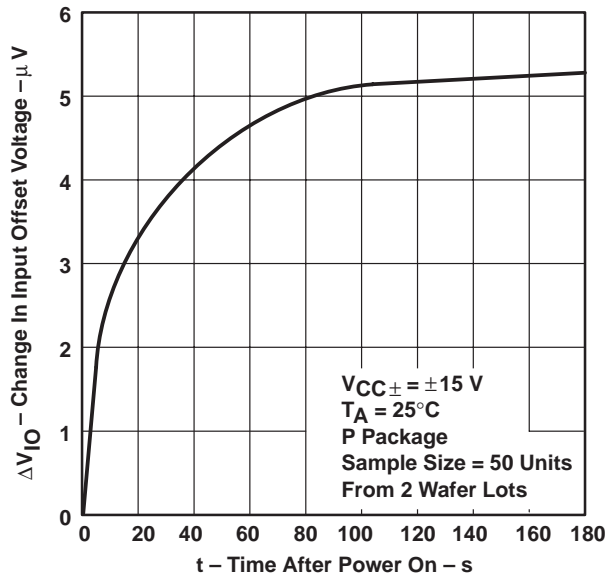

Figure 7

INPUT OFFSET CURRENT
 vs
 FREE-AIR TEMPERATURE

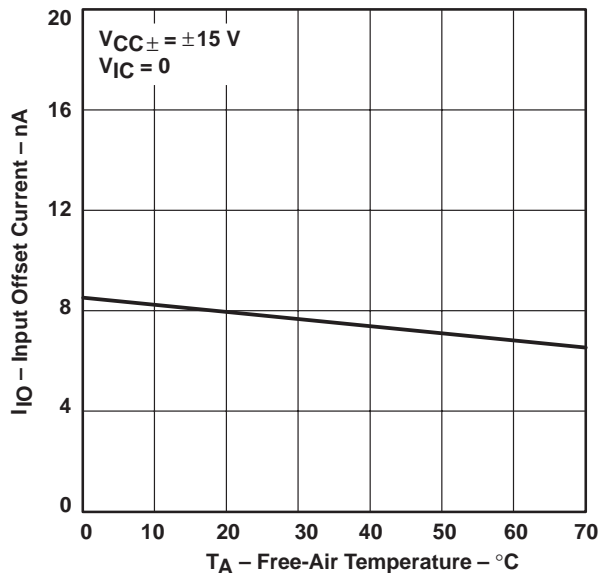

Figure 8

TYPICAL CHARACTERISTICS

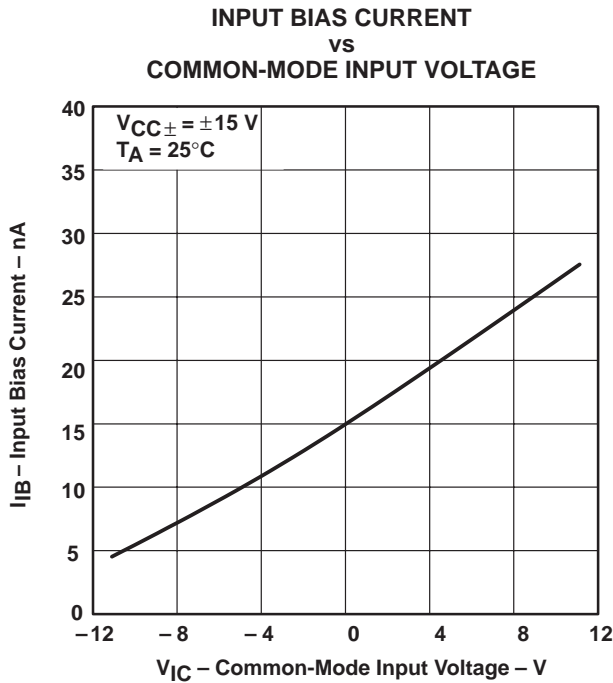

Figure 9

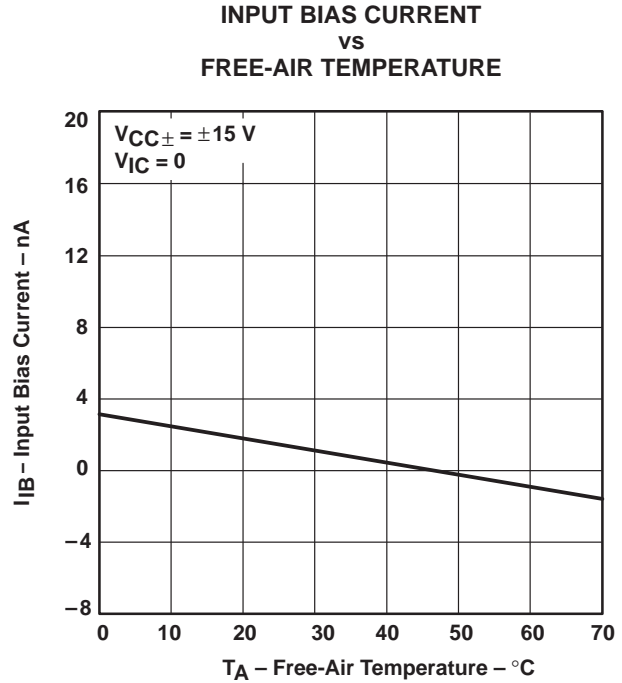

Figure 10

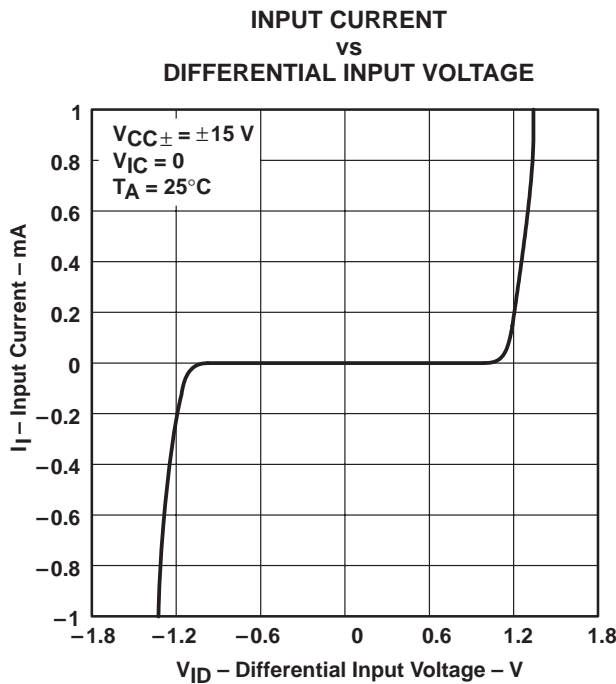

Figure 11

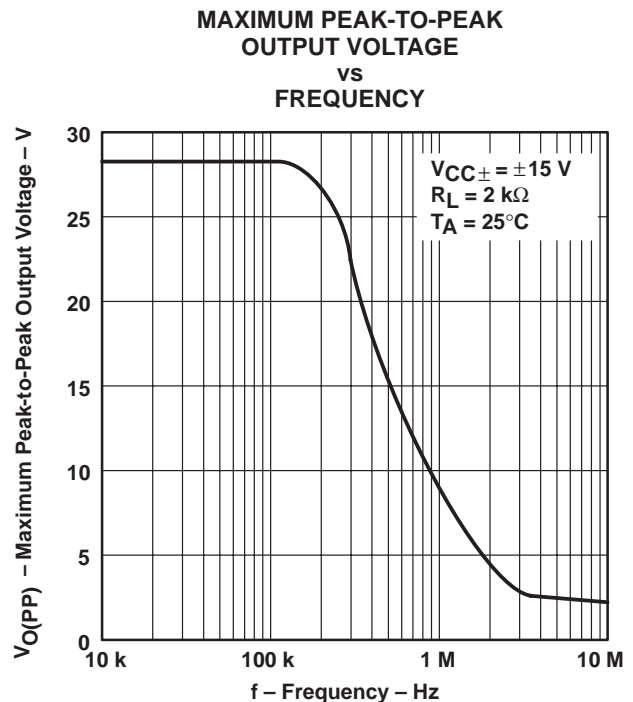

Figure 12

TYPICAL CHARACTERISTICS

MAXIMUM POSITIVE PEAK
 OUTPUT VOLTAGE
 VS
 LOAD RESISTANCE

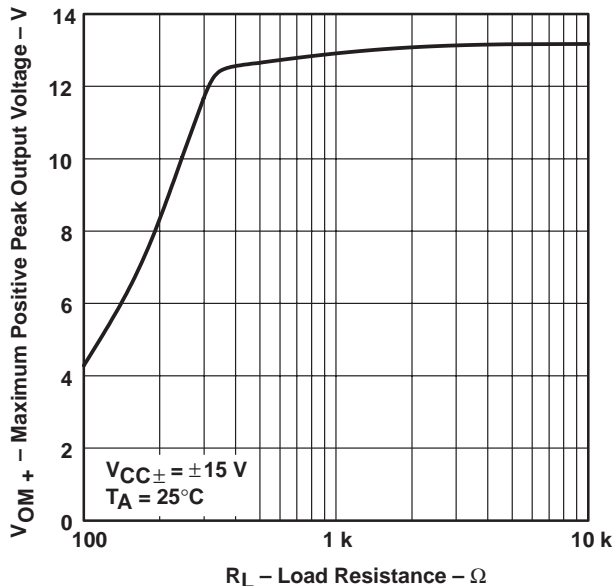

Figure 13

MAXIMUM NEGATIVE PEAK
 OUTPUT VOLTAGE
 VS
 LOAD RESISTANCE

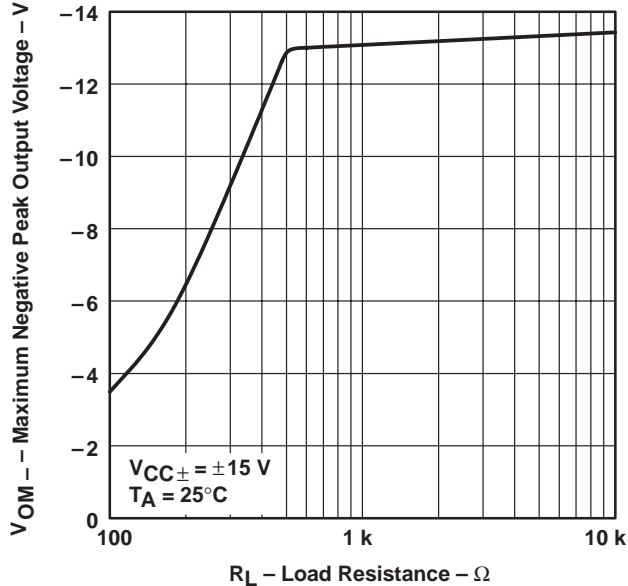

Figure 14

MAXIMUM POSITIVE PEAK
 OUTPUT VOLTAGE
 VS
 FREE-AIR TEMPERATURE

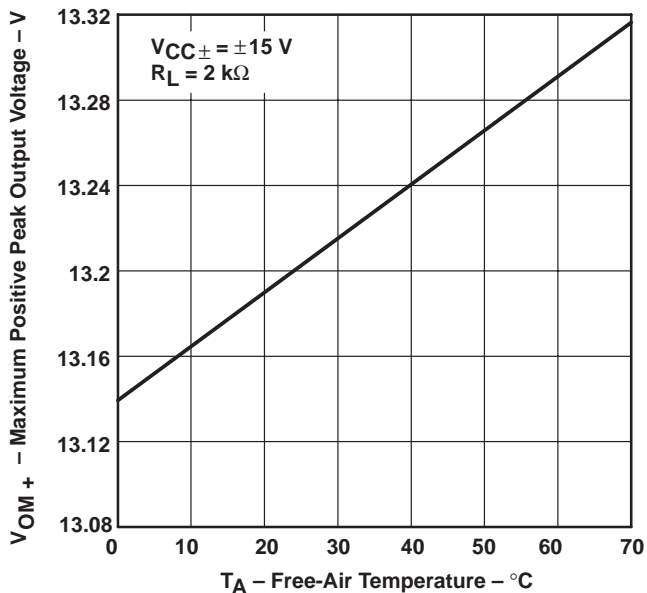

Figure 15

MAXIMUM NEGATIVE PEAK
 OUTPUT VOLTAGE
 VS
 FREE-AIR TEMPERATURE

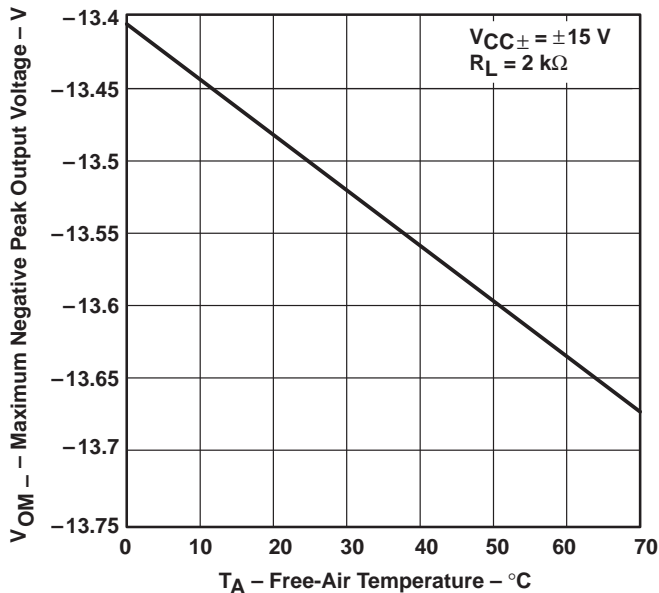

Figure 16



TYPICAL CHARACTERISTICS

LARGE-SIGNAL DIFFERENTIAL
 VOLTAGE AMPLIFICATION

vs
 SUPPLY VOLTAGE

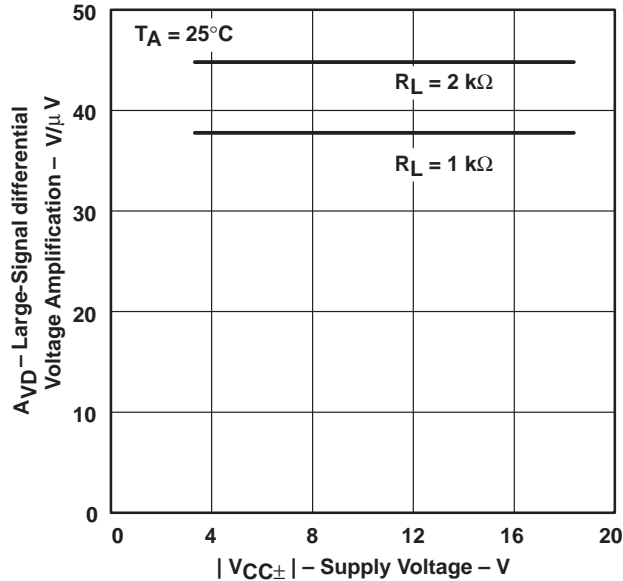

Figure 17

LARGE-SIGNAL DIFFERENTIAL VOLTAGE
 AMPLIFICATION AND PHASE SHIFT

vs
 FREQUENCY

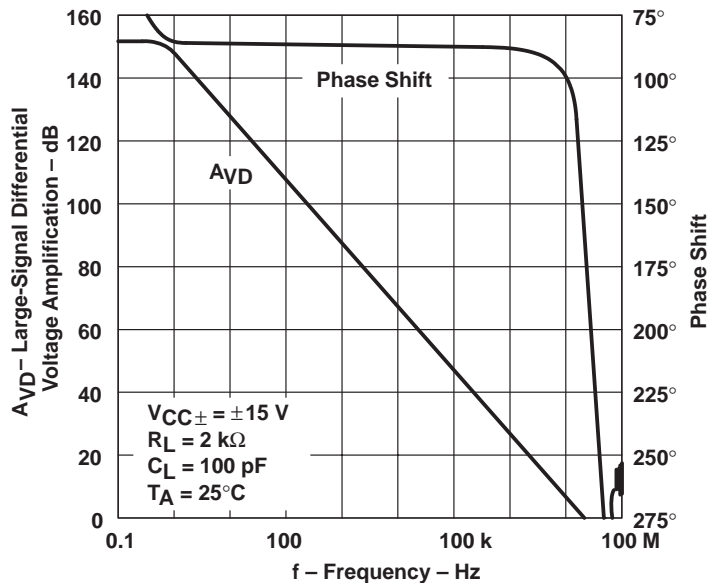

Figure 18

TYPICAL CHARACTERISTICS

LARGE-SIGNAL DIFFERENTIAL
 VOLTAGE AMPLIFICATION

vs
 LOAD RESISTANCE

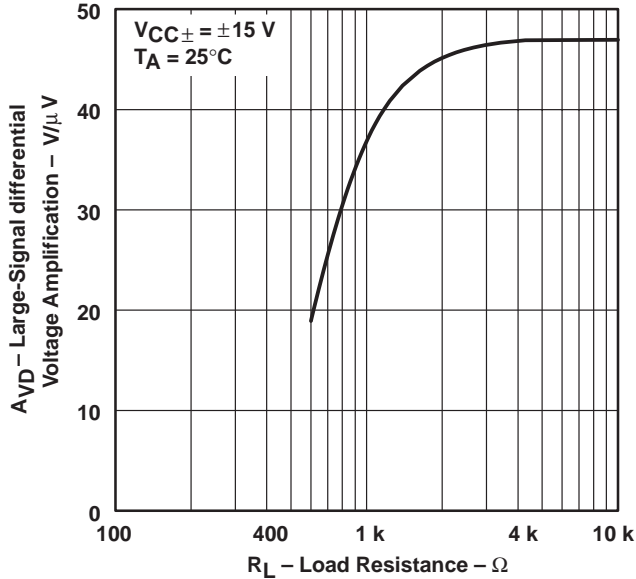

Figure 19

TLE2227
 LARGE-SIGNAL DIFFERENTIAL VOLTAGE
 AMPLIFICATION AND PHASE SHIFT

vs
 FREQUENCY

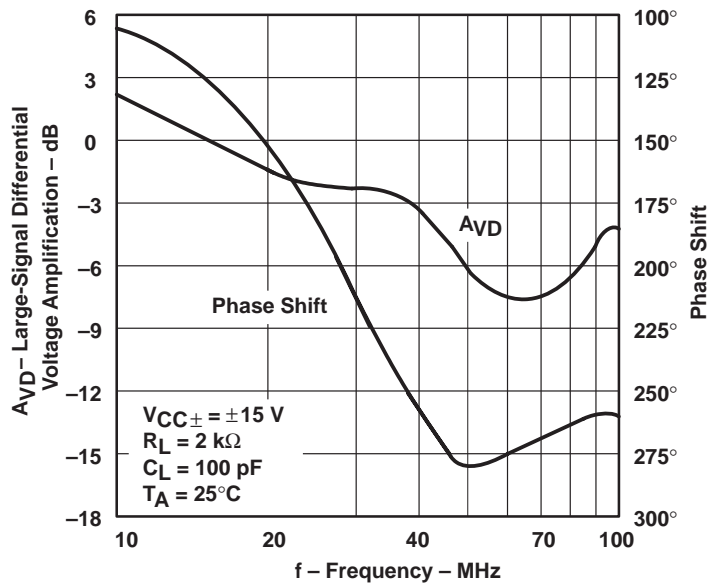

Figure 20

TYPICAL CHARACTERISTICS

TLE2037
 LARGE-SIGNAL DIFFERENTIAL VOLTAGE
 AMPLIFICATION AND PHASE SHIFT
 VS
 FREQUENCY

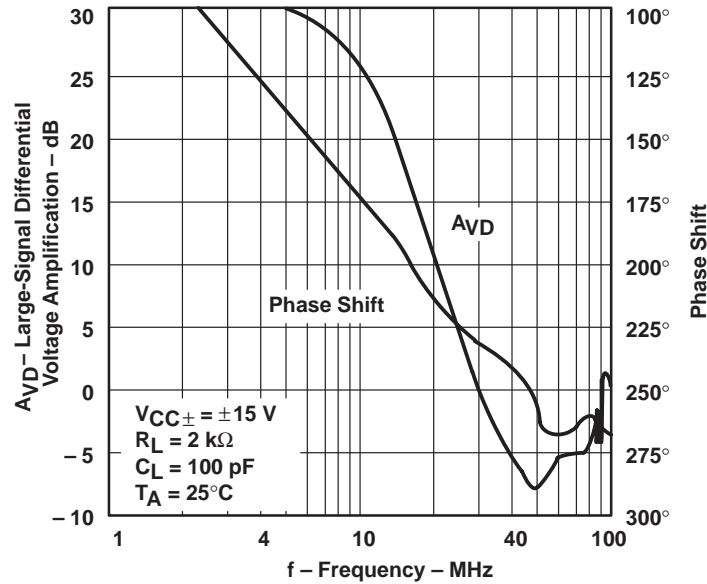

Figure 21

LARGE-SCALE DIFFERENTIAL
 VOLTAGE AMPLIFICATION
 VS
 FREE-AIR TEMPERATURE

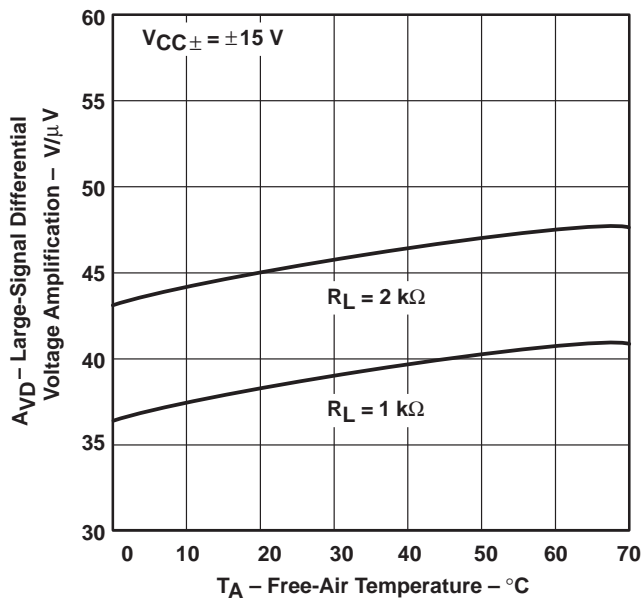

Figure 22

OUTPUT IMPEDANCE
 VS
 FREQUENCY

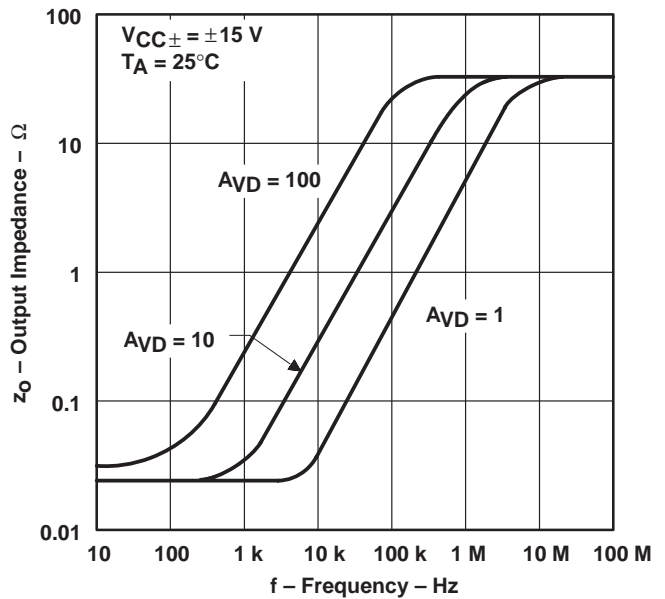

Figure 23

TYPICAL CHARACTERISTICS

COMMON-MODE REJECTION RATIO
 VS
 FREQUENCY

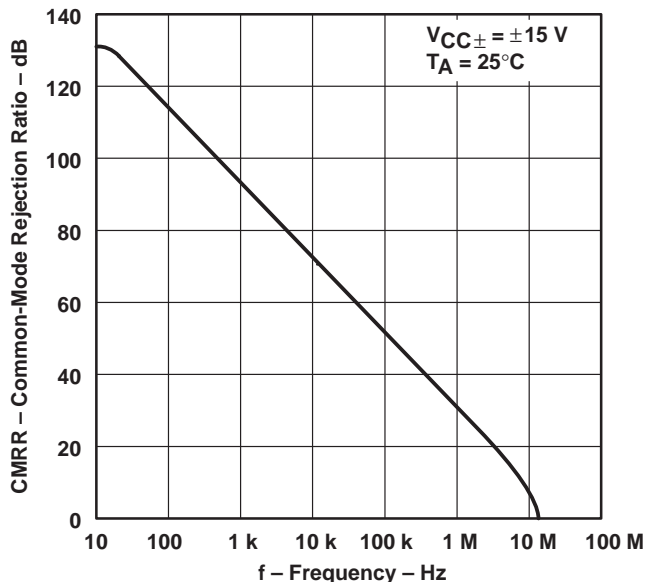

Figure 24

SUPPLY-VOLTAGE REJECTION RATIO
 VS
 FREQUENCY

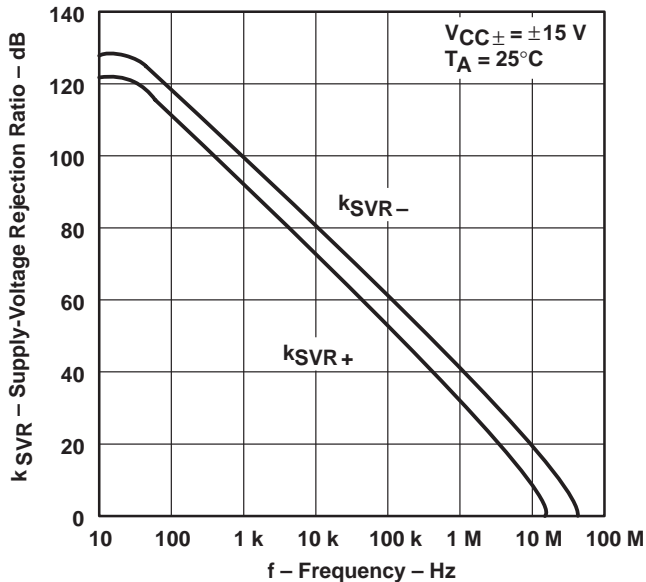

Figure 25

SHORT-CIRCUIT OUTPUT CURRENT
 VS
 SUPPLY VOLTAGE

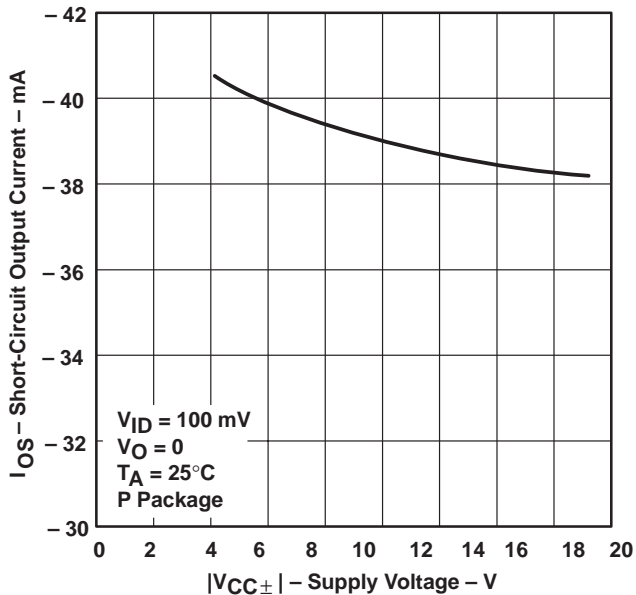

Figure 26

SHORT-CIRCUIT OUTPUT CURRENT
 VS
 SUPPLY VOLTAGE

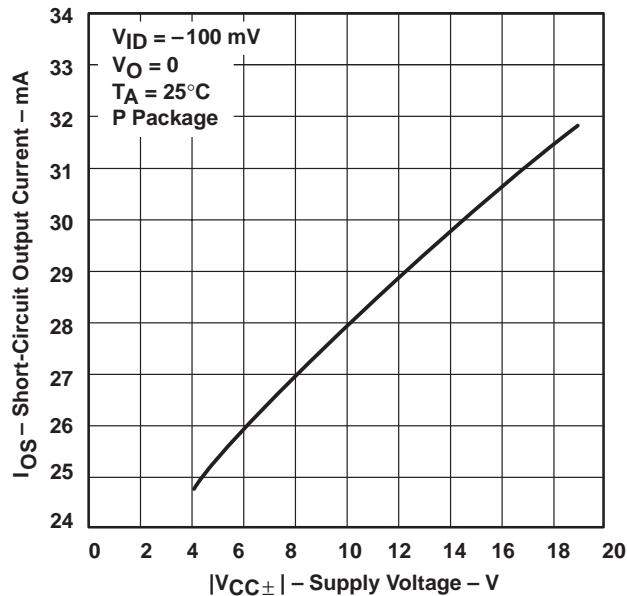

Figure 27

TYPICAL CHARACTERISTICS

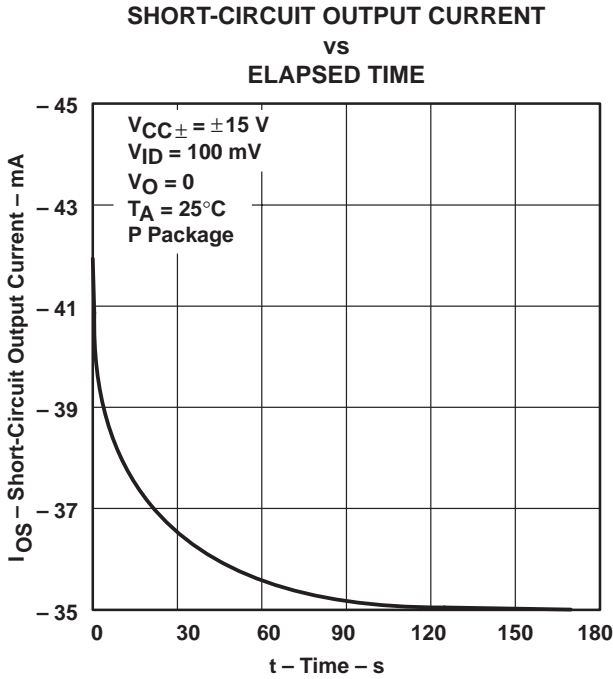

Figure 28

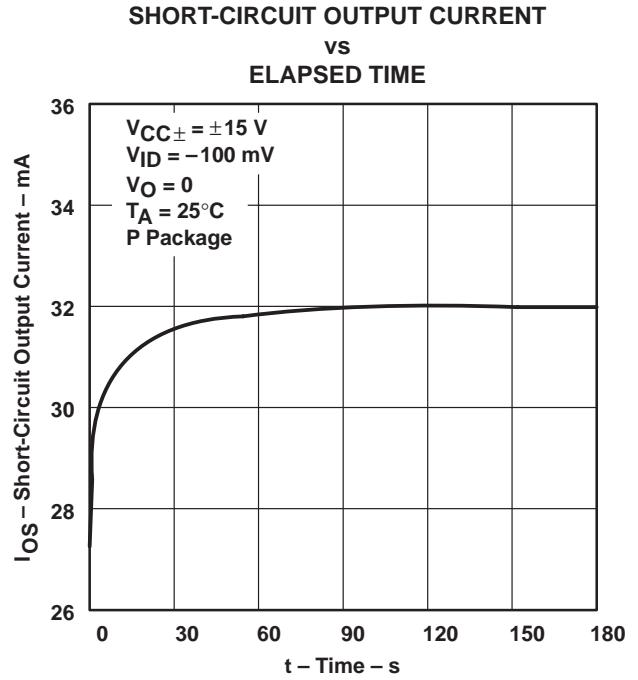

Figure 29

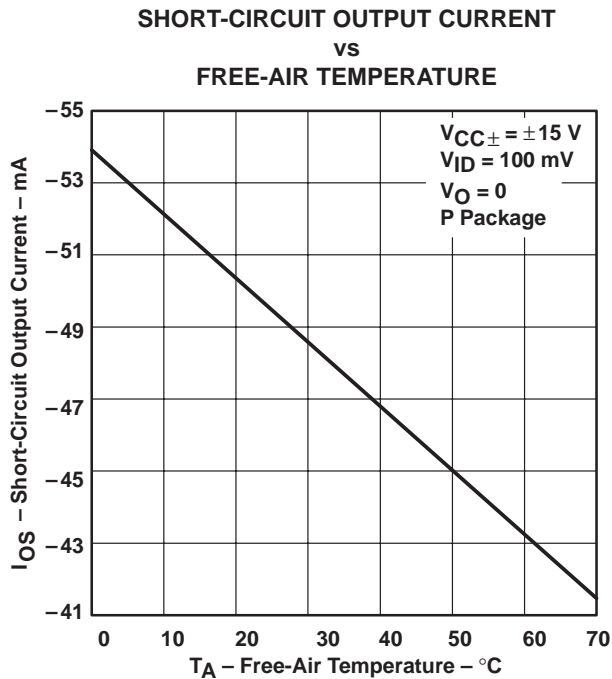

Figure 30

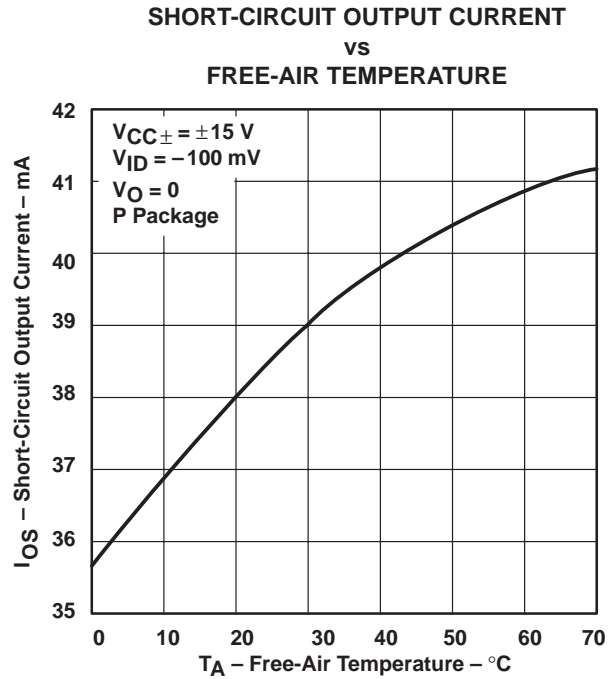
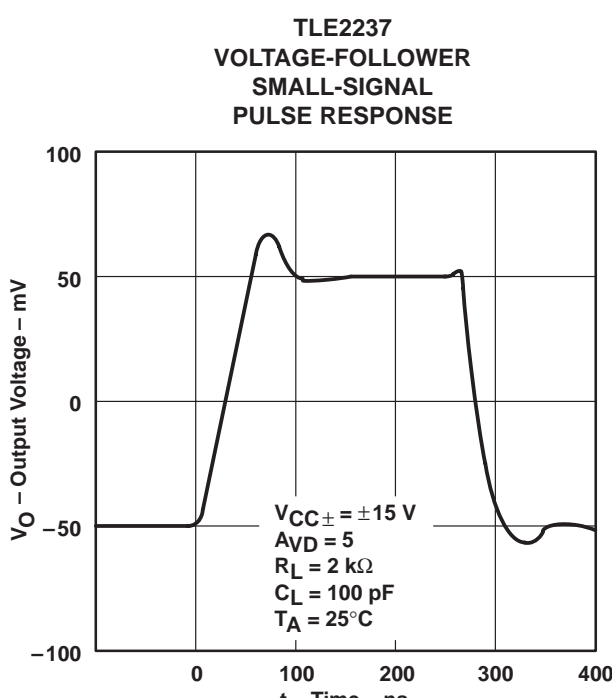
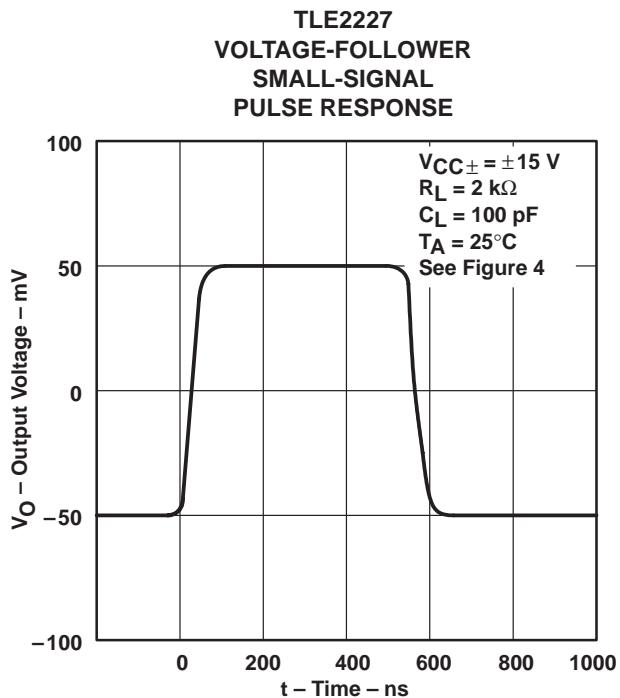
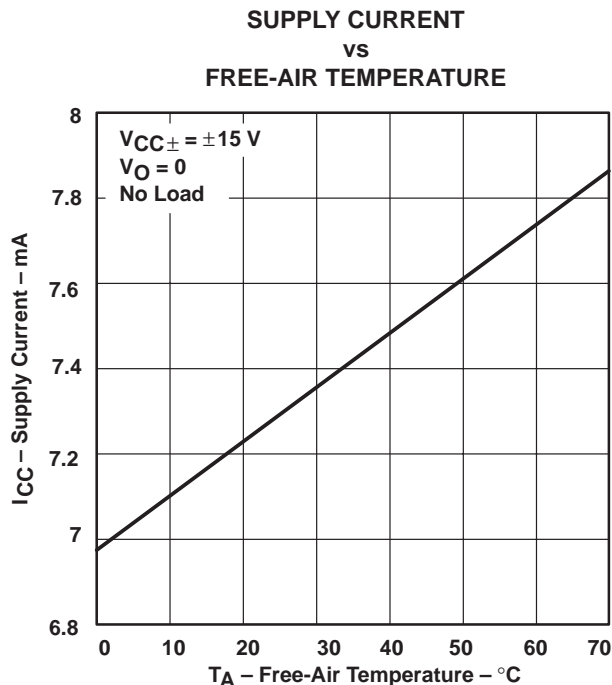
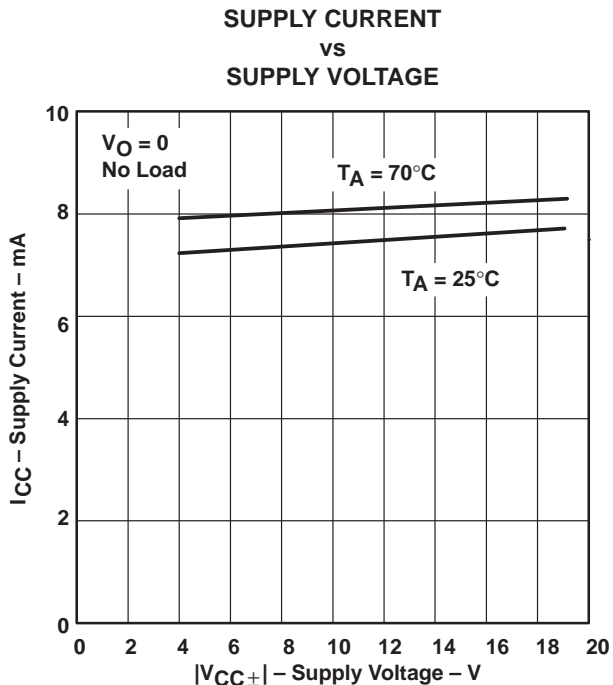

Figure 31

TYPICAL CHARACTERISTICS



TYPICAL CHARACTERISTICS

TLE2227
 VOLTAGE-FOLLOWER
 LARGE-SIGNAL
 PULSE RESPONSE

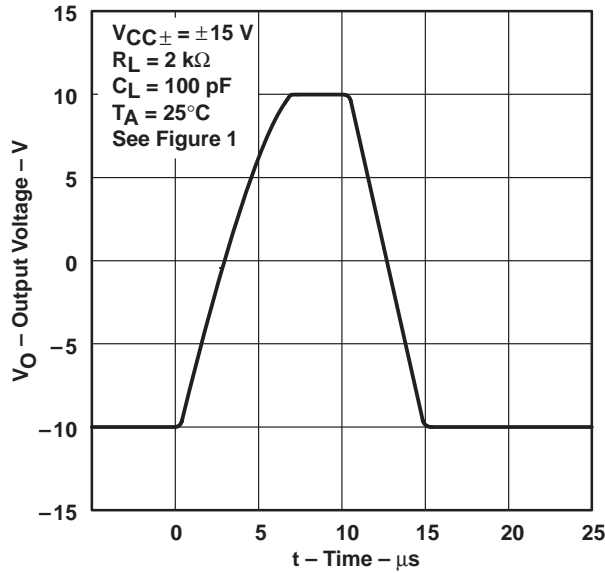

Figure 36

TLE2237
 VOLTAGE-FOLLOWER
 LARGE-SIGNAL
 PULSE RESPONSE

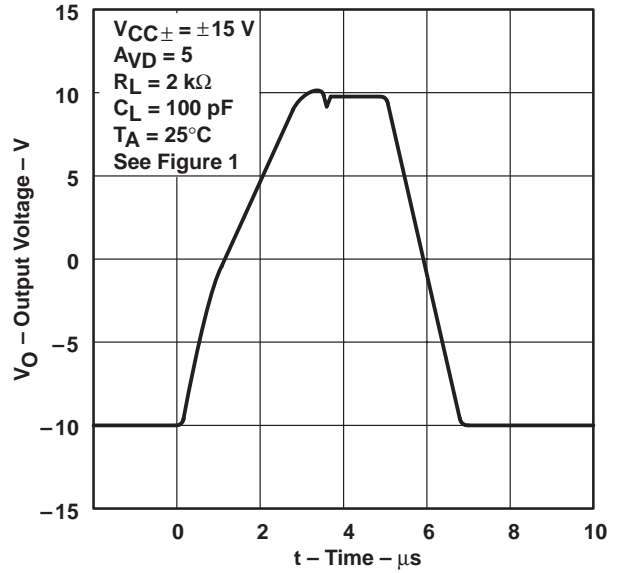

Figure 37

EQUIVALENT INPUT NOISE VOLTAGE
 vs
 FREQUENCY

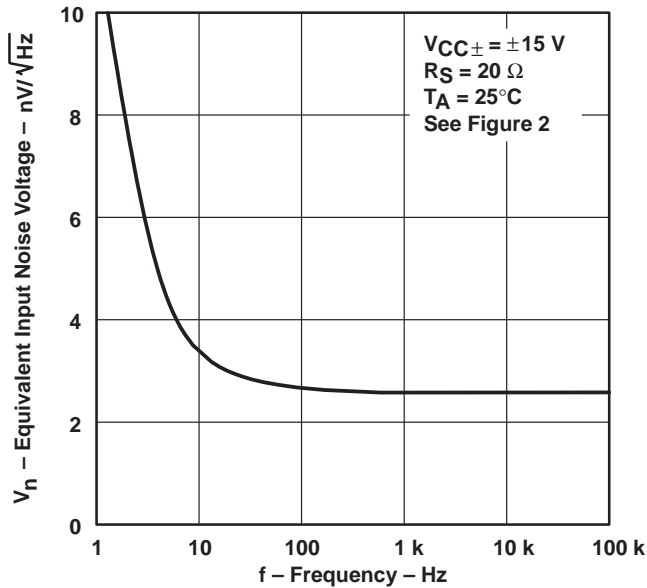

Figure 38

NOISE VOLTAGE
 (REFERRED TO INPUT)
 OVER A 10-SECOND INTERVAL

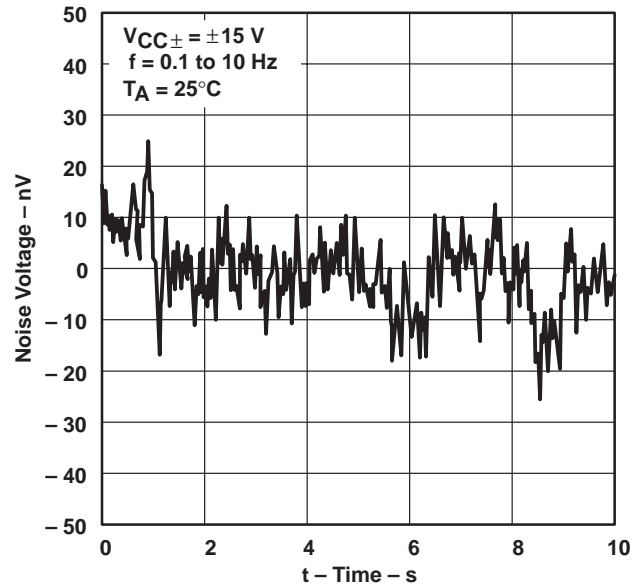

Figure 39

TYPICAL CHARACTERISTICS

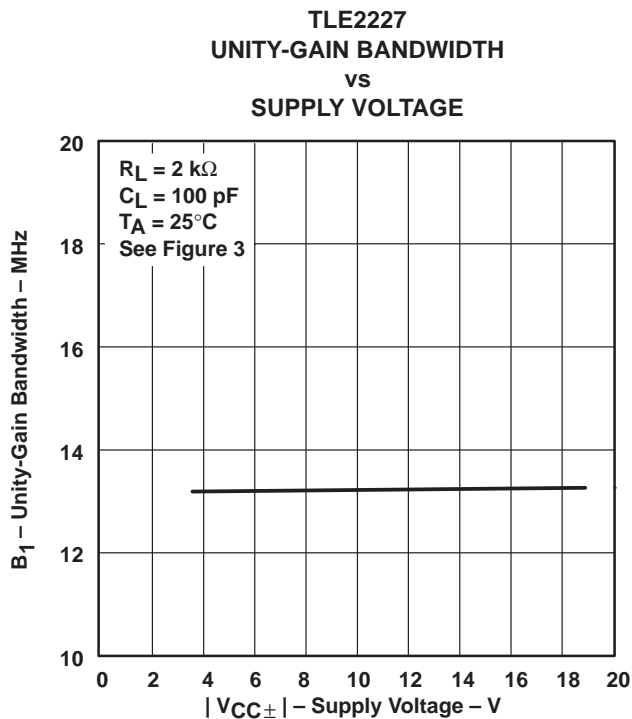

Figure 40

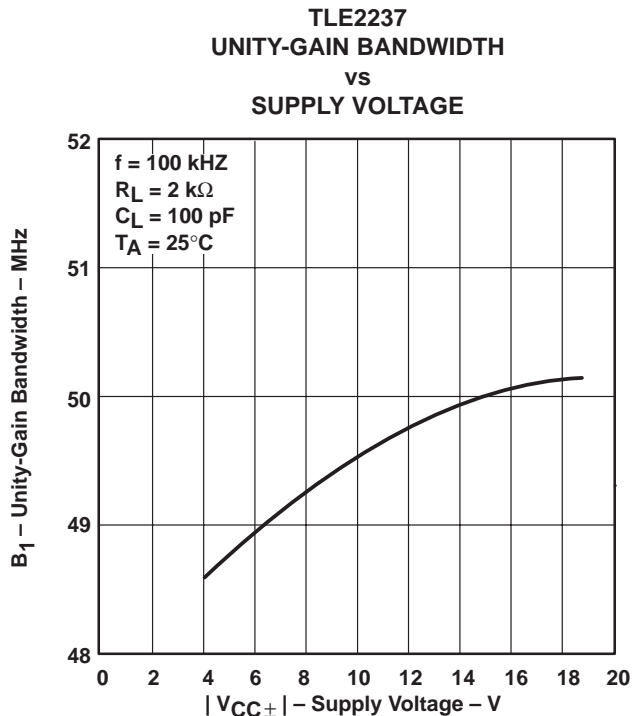

Figure 41

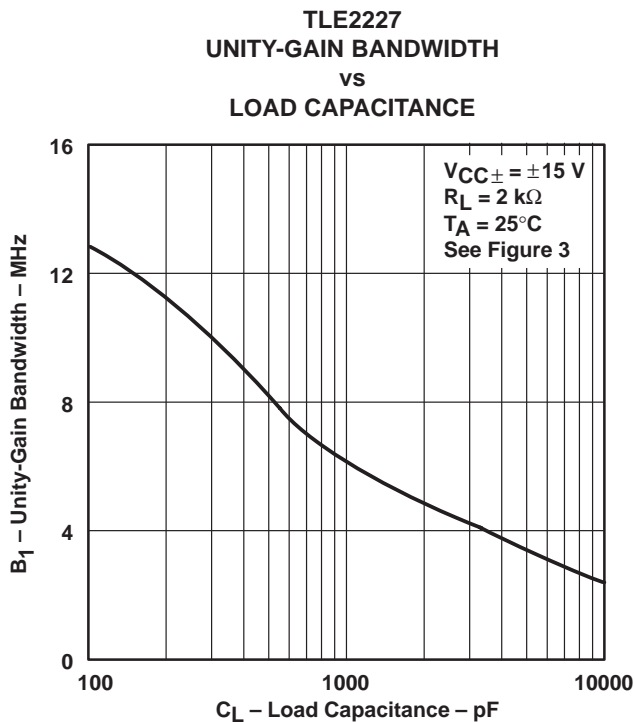

Figure 42

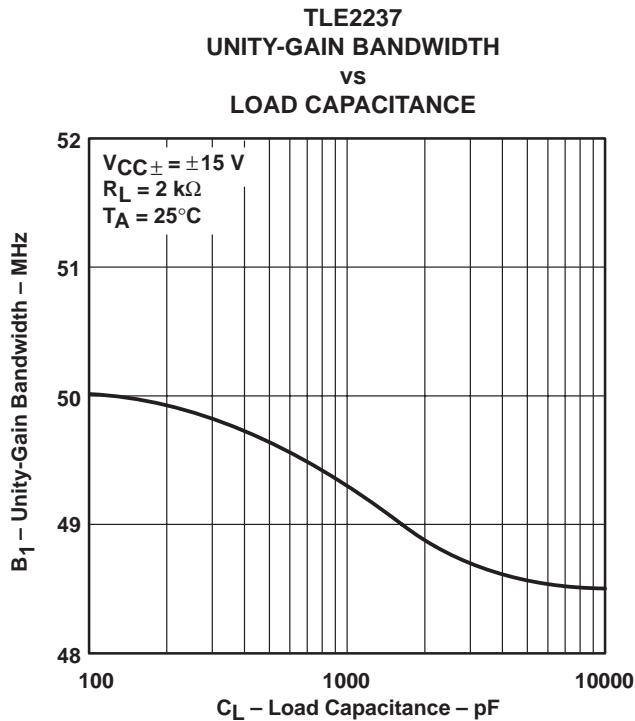

Figure 43

TYPICAL CHARACTERISTICS

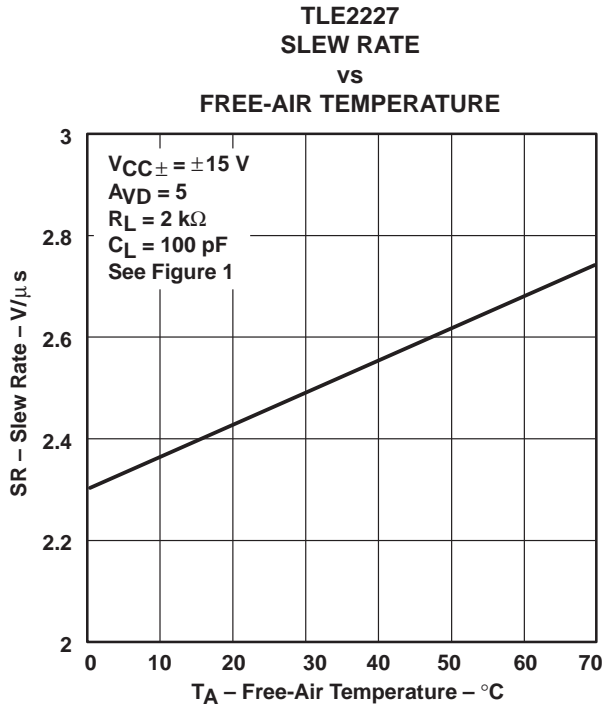

Figure 44

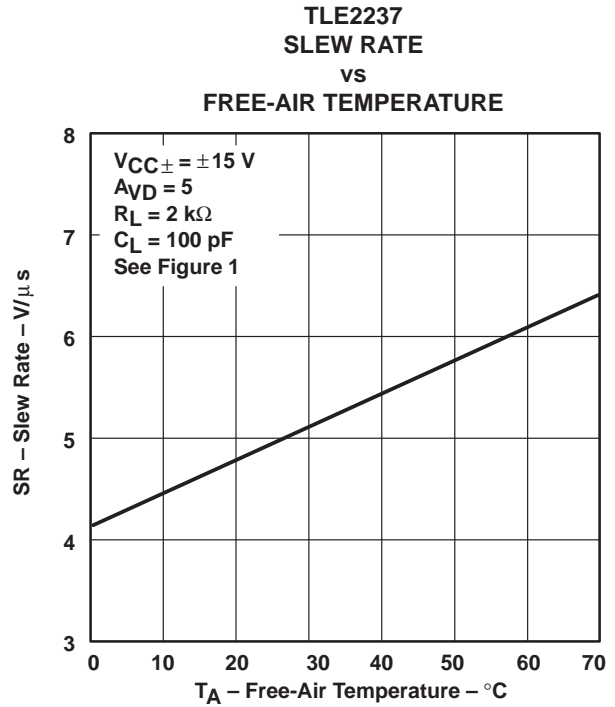

Figure 45

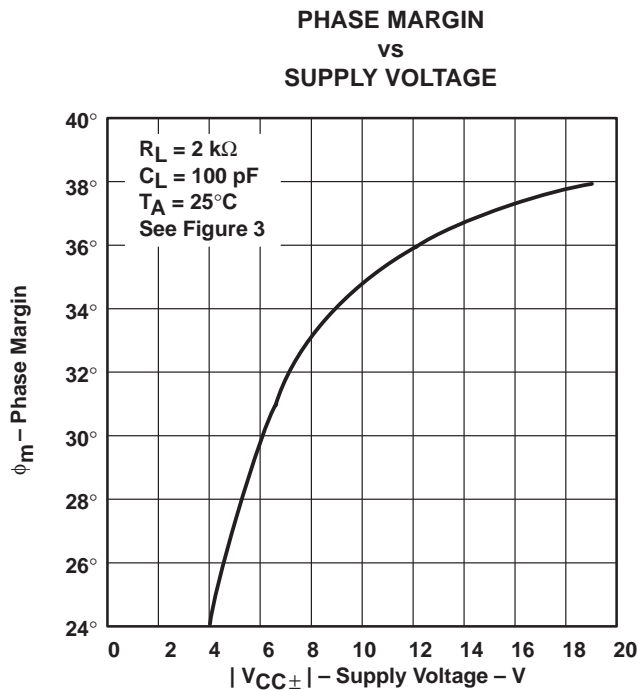

Figure 46

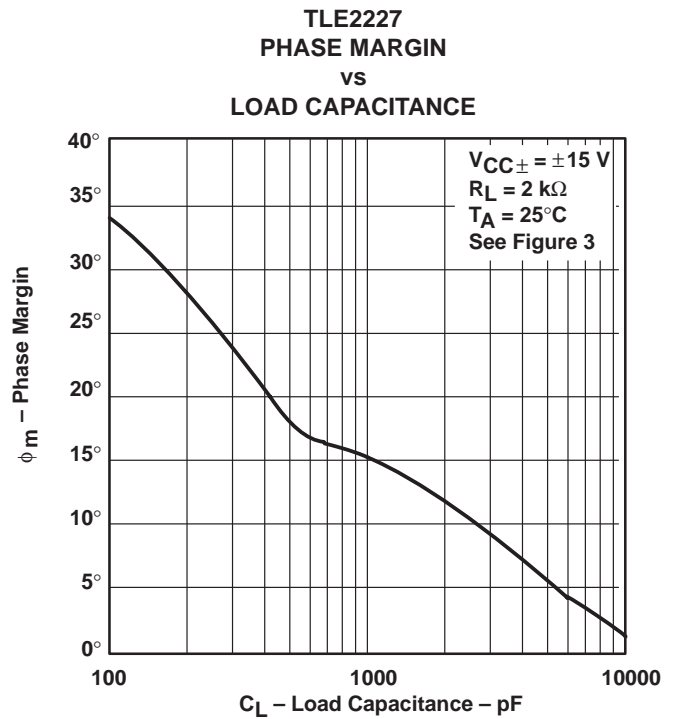

Figure 47

TLE2227, TLE2227Y, TLE2237, TLE2237Y EXCALIBUR LOW-NOISE HIGH-SPEED PRECISION DUAL OPERATIONAL AMPLIFIERS

SLOS184 – FEBRUARY 1997

TYPICAL CHARACTERISTICS

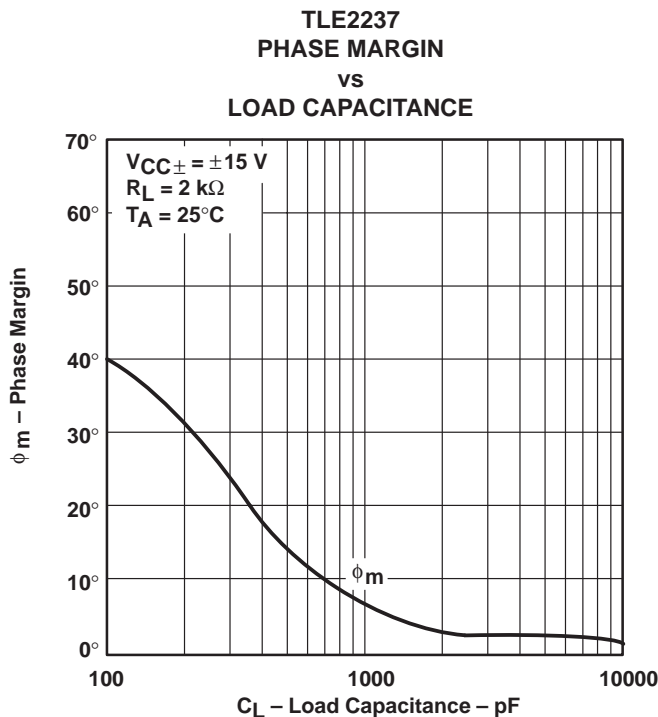

Figure 48

APPLICATION INFORMATION

TLE2227 macromodel information

Macromodel information provided was derived using Microsim *Parts*[™], the model generation software used with Microsim *PSpice*[™]. The Boyle macromodel (see Note 6) and subcircuit in Figure 49 and Figure 50 are generated using the TLE2227C typical electrical and operating characteristics at 25°C. Using this information, output simulations of the following key parameters can be generated to a tolerance of 20% (in most cases):

- Maximum positive output voltage swing
- Maximum negative output voltage swing
- Slew rate
- Quiescent power dissipation
- Input bias current
- Open-loop voltage amplification
- Unity-gain bandwidth
- Common-mode rejection ratio
- Phase margin
- DC output resistance
- AC output resistance
- Short-circuit output current limit

NOTE 6: G. R. Boyle, B. M. Cohn, D. O. Pederson, and J. E. Solomon, "Macromodeling of Integrated Circuit Operational Amplifiers", *IEEE Journal of Solid-State Circuits*, SC-9, 353 (1974).

PSpice and *Parts* are trademarks of MicroSim Corporation.

Macromodels, simulation models, or other models provided by TI, directly or indirectly, are not warranted by TI as fully representing all of the specification and operating characteristics of the semiconductor product to which the model relates.



POST OFFICE BOX 655303 • DALLAS, TEXAS 75265

APPLICATION INFORMATION

TLE2227 macromodel information (continued)

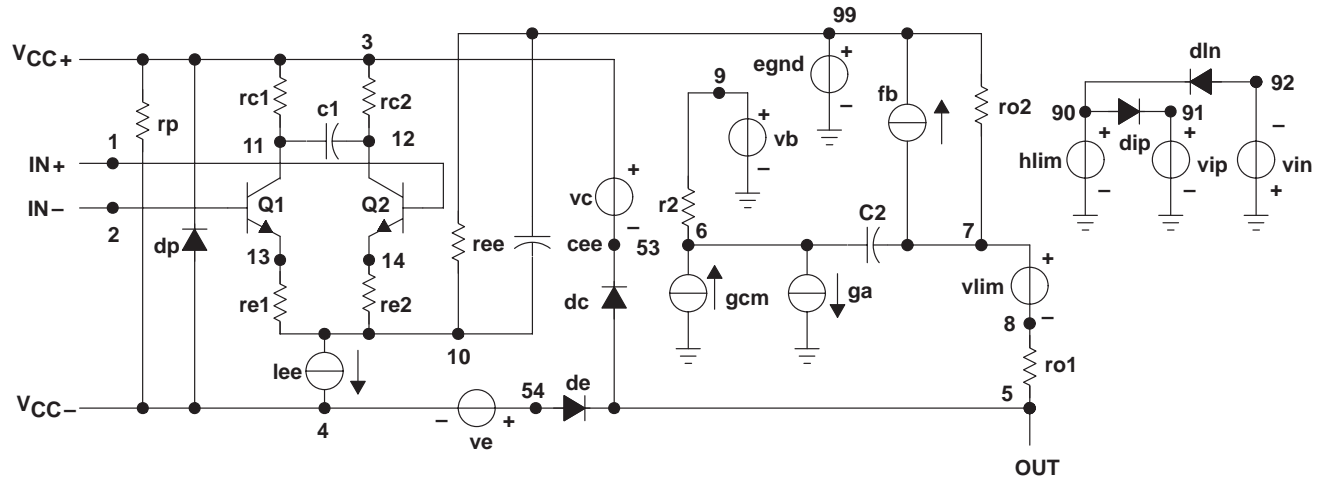

Figure 49. Boyle Macromodel

```
.subckt TLE2227 1 2 3 4 5
*
c1      11  12  4.003E-12
c2      6   7  20.00E-12
dc      5   53 dx
de      54  5  dx
dip     90  91 dx
dln     92  90 dx
dp      4   3  dx
egnd    99  0  poly(2)  (3,0) (4,0) 0 .5 .5
fb      7   99 poly(5)  vb vc ve vlp vln 0 954.8E6 -1E9 1E9 1E9 -1E9
ga      6   0  11 12 2.062E-3
gcm     0   6  10 99 531.3E-12
iee     10  4  dc 56.01E-6
hlim    90  0  vlim 1K
q1      11  2  13 qx
q2      12  1  14 qx
r2      6   9  100.0E3
rc1     3   11 530.5
rc2     3   12 530.5
re1     13  10 -393.2
re2     14  10 -393.2
ree     10  99 3.571E6
ro1     8   5  25
ro2     7   99 25
rp      3   4  8.013E3
vb      9   0  dc 0
vc      3   53 dc 2.400
ve      54  4  dc 2.100
vlim    7   8  dc 0
vlp     91  0  dc 40
vln     0   92 dc 40
.model  dx D(Is=800.0E-18)
.model  qx NPN(Is=800.0E-18 Bf=7.000E3)
.ends
```

Figure 50. TLE2227 Macromodel Subcircuit

TLE2227, TLE2227Y, TLE2237, TLE2237Y EXCALIBUR LOW-NOISE HIGH-SPEED PRECISION DUAL OPERATIONAL AMPLIFIERS

SLOS184 – FEBRUARY 1997

TLE2037 macromodel information

Macromodel information provided is derived using *PSpice™ Parts™* model generation software. The Boyle macromodel (see Note 6) and subcircuit in Figure 51 and Figure 52 are generated using the TLE2237C typical electrical and operating characteristics at 25°C. Using this information, output simulations of the following key parameters can be generated to a tolerance of 20% (in most cases):

- Maximum positive output voltage swing
- Maximum negative output voltage swing
- Slew rate
- Quiescent power dissipation
- Input bias current
- Open-loop voltage amplification
- Unity-gain bandwidth
- Common-mode rejection ratio
- Phase margin
- DC output resistance
- AC output resistance
- Short-circuit output current limit

NOTE 6. G. R. Boyle, B. M. Cohn, D. O. Pederson, and J. E. Solomon, "Macromodeling of Integrated Circuit Operational Amplifiers," *IEEE Journal of Solid-State Circuits*, SC-9, 353 (1974).

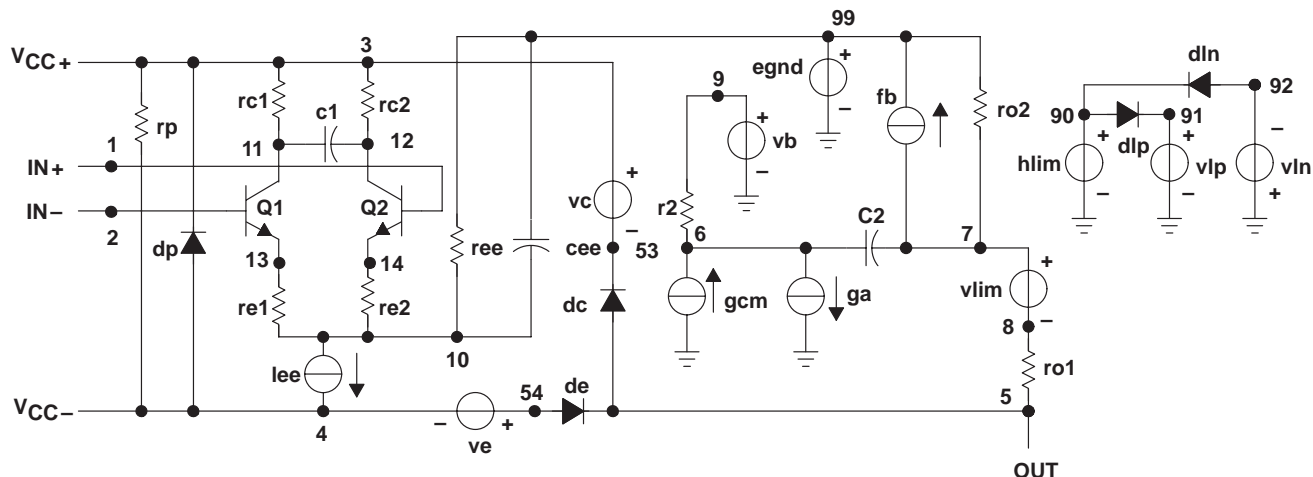

Figure 51. Boyle Macromodel

APPLICATION INFORMATION

TLE2037 macromodel information (continued)

```
.subckt TLE2227 1 2 3 4 5
*
c1 11 12 4.003E-12
c2 6 7 20.00E-12
dc 5 53 dx
de 54 5 dx
dlp 90 91 dx
dln 92 90 dx
dp 4 3 dx
egnd 99 0 poly(2) (3,0) (4,0) 0 .5 .5
fb 7 99 poly(5) vb vc ve vlp vln 0 954.8E6 -1E9 1E9 1E9 -1E9
ga 6 0 11 12 2.062E-3
gcm 0 6 10 99 531.3E-12
iee 10 4 dc 56.01E-6
hlim 90 0 vlim 1K
q1 11 2 13 qx
q2 12 1 14 qx
r2 6 9 100.0E3
rc1 3 11 530.5
rc2 3 12 530.5
re1 13 10 -393.2
re2 14 10 -393.2
ree 10 99 3.571E6
ro1 8 5 25
ro2 7 99 25
rp 3 4 8.013E3
vb 9 0 dc 0
vc 3 53 dc 2.400
ve 54 4 dc 2.100
vlim 7 8 dc 0
vlp 91 0 dc 40
vln 0 92 dc 40
.model dx D(Is=800.0E-18)
.model qx NPN(Is=800.0E-18 Bf=7.000E3)
.ends
```

Figure 52. TLE2237 Macromodel Subcircuit

APPLICATION INFORMATION

voltage-follower applications

The TLE22x7C circuitry includes input-protection diodes to limit the voltage across the input transistors; however, no provision is made in the circuit to limit the current if these diodes are forward biased. This condition can occur when the device is operated in the voltage-follower configuration and driven with a fast, large-signal pulse. A feedback resistor is recommended to limit the current to a maximum of 1 mA to prevent degradation of the device. Also, this feedback resistor forms a pole with the input capacitance of the device. For feedback resistor values greater than 10 k Ω , this pole degrades the amplifier's phase margin. This problem can be alleviated by adding a capacitor (20 pF to 50 pF) in parallel with the feedback resistor (see Figure 53).

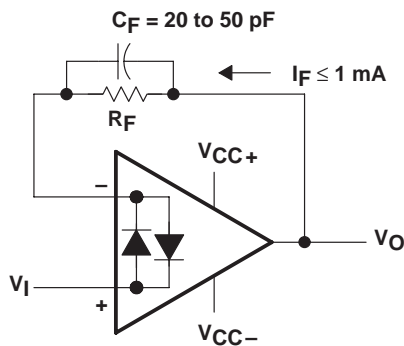

Figure 53. Voltage-Follower Circuit

IMPORTANT NOTICE

Texas Instruments and its subsidiaries (TI) reserve the right to make changes to their products or to discontinue any product or service without notice, and advise customers to obtain the latest version of relevant information to verify, before placing orders, that information being relied on is current and complete. All products are sold subject to the terms and conditions of sale supplied at the time of order acknowledgement, including those pertaining to warranty, patent infringement, and limitation of liability.

TI warrants performance of its semiconductor products to the specifications applicable at the time of sale in accordance with TI's standard warranty. Testing and other quality control techniques are utilized to the extent TI deems necessary to support this warranty. Specific testing of all parameters of each device is not necessarily performed, except those mandated by government requirements.

CERTAIN APPLICATIONS USING SEMICONDUCTOR PRODUCTS MAY INVOLVE POTENTIAL RISKS OF DEATH, PERSONAL INJURY, OR SEVERE PROPERTY OR ENVIRONMENTAL DAMAGE ("CRITICAL APPLICATIONS"). TI SEMICONDUCTOR PRODUCTS ARE NOT DESIGNED, AUTHORIZED, OR WARRANTED TO BE SUITABLE FOR USE IN LIFE-SUPPORT DEVICES OR SYSTEMS OR OTHER CRITICAL APPLICATIONS. INCLUSION OF TI PRODUCTS IN SUCH APPLICATIONS IS UNDERSTOOD TO BE FULLY AT THE CUSTOMER'S RISK.

In order to minimize risks associated with the customer's applications, adequate design and operating safeguards must be provided by the customer to minimize inherent or procedural hazards.

TI assumes no liability for applications assistance or customer product design. TI does not warrant or represent that any license, either express or implied, is granted under any patent right, copyright, mask work right, or other intellectual property right of TI covering or relating to any combination, machine, or process in which such semiconductor products or services might be or are used. TI's publication of information regarding any third party's products or services does not constitute TI's approval, warranty or endorsement thereof.