

TLV2450, TLV2451, TLV2452, TLV2453, TLV2454, TLV2455, TLV245xA FAMILY OF 23- μ A 220-KHz RAIL-TO-RAIL INPUT/OUTPUT OPERATIONAL AMPLIFIERS WITH SHUTDOWN

SLOS218B – DECEMBER 1998 – REVISED JUNE 1999

- Supply Current . . . 23 μ A/Channel
- Gain-Bandwidth Product . . . 220 kHz
- Output Drive Capability . . . \pm 10 mA
- Input Offset Voltage . . . 20 μ V (typ)
- V_{DD} Range . . . 2.7 V to 6 V
- Power Supply Rejection Ratio . . . 106 dB
- Ultra-Low Power Shutdown Mode
 I_{DD} . . . 16 nA/ch
- Rail-To-Rail Input/Output (RRIO)
- Ultra-Small Packaging
 - 5 or 6 Pin SOT-23 (TLV2450/1)
 - 8 or 10 Pin MSOP (TLV2452/3)

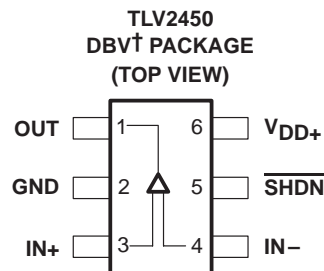

\dagger This device is in the Product Preview stage of development. Please contact your local TI sales office for availability.

description

The TLV245x is a family of rail-to-rail input/output operational amplifiers that set a new performance point for supply current and ac performance. These devices consume a mere 23 μ A/channel while offering 220 kHz of gain bandwidth product; much higher than competitive devices with similar supply current levels. Along with increased ac performance, the amplifier provides high output drive capability, solving a major shortcoming of older micropower rail-to-rail input/output operational amplifiers. The TLV245x can swing to within 250 mV of each supply rail while driving a 2.5-mA load. Both the inputs and outputs swing rail-to-rail for increased dynamic range in low-voltage applications. This performance makes the TLV245x family ideal for portable medical equipment, patient monitoring systems, and data acquisition circuits.

Three members of the family (TLV2450/3/5) offer a shutdown terminal for conserving battery life in portable applications. During shutdown, the outputs are placed in a high-impedance state and the amplifier consumes only 16 nA/channel. The family is fully specified at 3 V and 5 V across an expanded industrial temperature range (-40°C to 125°C). The singles and duals are available in the SOT23 and MSOP packages, while the quads are available in TSSOP. The TLV2450 offers an amplifier with shutdown functionality all in a 6-pin SOT23 package, making it perfect for high density circuits.

FAMILY PACKAGE TABLE

DEVICE	NUMBER OF CHANNELS	PACKAGE TYPES					SHUTDOWN	UNIVERSAL EVM BOARD
		PDIP	SOIC	SOT-23	TSSOP	MSOP		
TLV2450	1	8	8	6 \ddagger	—	—	Yes	UNIV-OPAMP-2
TLV2451	1	8	8	5	—	—	—	UNIV-OPAMP-1
TLV2452	2	8	8	—	—	8	—	UNIV-OPAMP-1
TLV2453	2	14	14	—	—	10	Yes	UNIV-OPAMP-2
TLV2454	4	14	14	—	14	—	—	—
TLV2455	4	16	16	—	16	—	Yes	—

\ddagger This device is in the Product Preview stage of development. Contact your local TI sales office for availability.



Please be aware that an important notice concerning availability, standard warranty, and use in critical applications of Texas Instruments semiconductor products and disclaimers thereto appears at the end of this data sheet.

This document contains information on products in more than one phase of development. The status of each device is indicated on the page(s) specifying its electrical characteristics.

 **TEXAS
INSTRUMENTS**

POST OFFICE BOX 655303 • DALLAS, TEXAS 75265

Copyright © 1999, Texas Instruments Incorporated

TLV2450, TLV2451, TLV2452, TLV2453, TLV2454, TLV2455, TLV245xA

FAMILY OF 23- μ A 220-kHz RAIL-TO-RAIL INPUT/OUTPUT OPERATIONAL AMPLIFIERS WITH SHUTDOWN

SLOS218B – DECEMBER 1998 – REVISED JUNE 1999

TLV2450 and TLV2451 AVAILABLE OPTIONS

T _A	PACKAGED DEVICES				CHIP FORM‡ (Y)
	SMALL OUTLINE (D)†	SOT-23		PLASTIC DIP (P)	
		(DBV)†	SYMBOL		
0°C to 70°C	TLV2450CD§ TLV2451CD	TLV2450CDBV TLV2451CDBV	VAQC VARC	TLV2450CP TLV2451CP	TLV2450Y TLV2451Y
-40°C to 125°C	TLV2450ID§ TLV2451ID	TLV2450IDBV TLV2451IDBV	VAQI VARI	TLV2450IP TLV2451IP	— —
	TLV2450AID TLV2451AID	— —	— —	TLV2450AIP TLV2451AIP	— —

† This package is available taped and reeled. To order this packaging option, add an R suffix to the part number (e.g., TLV2450CDR).

‡ Chip forms are tested at T_A = 25°C only.

§ This device is in the Product Preview stage of development. Contact your local TI sales office for availability.

TLV2452 and TLV2453 AVAILABLE OPTIONS

T _A	PACKAGED DEVICES						CHIP FORM‡ (Y)	
	SMALL OUTLINE (D)†	MSOP				PLASTIC DIP (N)		PLASTIC DIP (P)
		(DGK)†	SYMBOL§	(DGS)†	SYMBOL§			
0°C to 70°C	TLV2452CD TLV2453CD	TLV2452CDGK —	xxTIABI —	— TLV2453CDGS	— xxTIABK	— TLV2453CN	TLV2452CP — TLV2453Y	
-40°C to 125°C	TLV2452ID TLV2453ID	TLV2452IDGK —	xxTIABJ —	— TLV2453IDGS	— xxTIABL	— TLV2453IN	TLV2452IP — —	
	TLV2452AID TLV2453AID	— —	— —	— —	— —	— TLV2453AIN	TLV2452AIP — —	

† This package is available taped and reeled. To order this packaging option, add an R suffix to the part number (e.g., TLV2452CDR).

‡ Chip forms are tested at T_A = 25°C only.

§ xx represents the device date code.

TLV2454 and TLV2455 AVAILABLE OPTIONS

T _A	PACKAGED DEVICES			CHIP FORM‡ (Y)
	SMALL OUTLINE (D)†	PLASTIC DIP (N)	TSSOP (PW)†	
0°C to 70°C	TLV2454CD TLV2455CD	TLV2454CN TLV2455CN	TLV2454CPW TLV2455CPW	TLV2454Y TLV2455Y
-40°C to 125°C	TLV2454ID TLV2455ID	TLV2454IN TLV2455IN	TLV2454IPW TLV2455IPW	— —
	TLV2454AID TLV2455AID	TLV2454AIN TLV2455AIN	TLV2454AIPW TLV2455AIPW	— —

† This package is available taped and reeled. To order this packaging option, add an R suffix to the part number (e.g., TLV2454CDR).

‡ Chip forms are tested at T_A = 25°C only.



TLV2450, TLV2451, TLV2452, TLV2453, TLV2454, TLV2455, TLV245xA
 FAMILY OF 23- μ A 220-kHz RAIL-TO-RAIL INPUT/OUTPUT
 OPERATIONAL AMPLIFIERS WITH SHUTDOWN

SLOS218B – DECEMBER 1998 – REVISED JUNE 1999

TLV245x PACKAGE PINOUTS

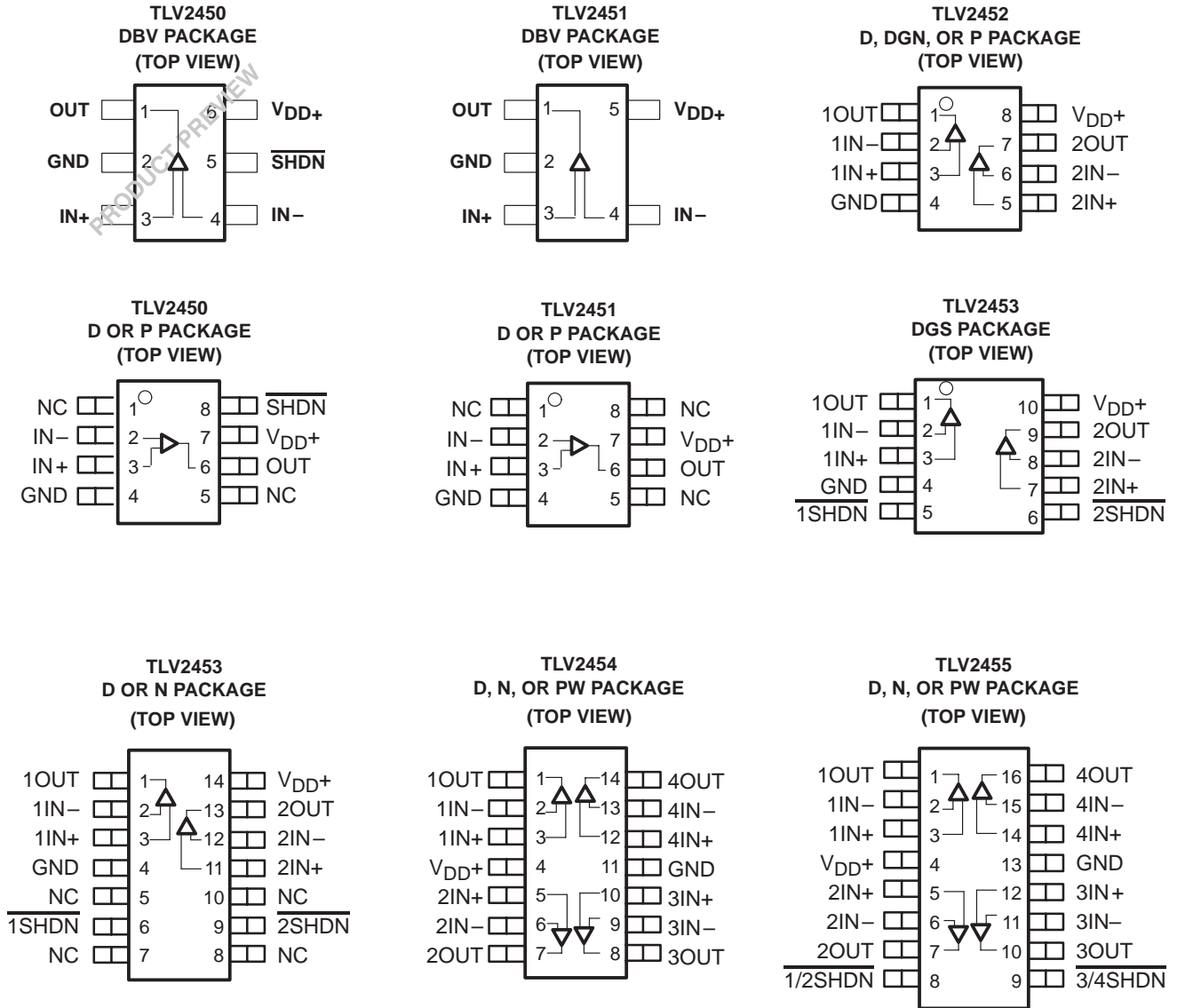

NC – No internal connection

TLV2450, TLV2451, TLV2452, TLV2453, TLV2454, TLV2455, TLV245xA

FAMILY OF 23- μ A 220-kHz RAIL-TO-RAIL INPUT/OUTPUT OPERATIONAL AMPLIFIERS WITH SHUTDOWN

SLOS218B – DECEMBER 1998 – REVISED JUNE 1999

absolute maximum ratings over operating free-air temperature range (unless otherwise noted)[†]

Supply voltage, V_{DD} (see Note 1)	7 V
Differential input voltage, V_{ID}	$\pm V_{DD}$
Continuous total power dissipation	See Dissipation Rating Table
Operating free-air temperature range, T_A : C suffix	0°C to 70°C
I suffix	-40°C to 125°C
Maximum junction temperature, T_J	150°C
Storage temperature range, T_{stg}	-65°C to 150°C
Lead temperature 1,6 mm (1/16 inch) from case for 10 seconds	260°C

[†] Stresses beyond those listed under “absolute maximum ratings” may cause permanent damage to the device. These are stress ratings only, and functional operation of the device at these or any other conditions beyond those indicated under “recommended operating conditions” is not implied. Exposure to absolute-maximum-rated conditions for extended periods may affect device reliability.

NOTE: All voltage values, except differential voltages, are with respect to V_{DD-} .

DISSIPATION RATING TABLE

PACKAGE	θ_{JC} (°C/W)	θ_{JA} (°C/W)	$T_A \leq 25^\circ\text{C}$ POWER RATING
D (8)	38.3	176	710 mW
D (14)	26.9	122.3	1022 mW
D (16)	25.7	114.7	1090 mW
DBV (5)	55	324.1	385 mW
DBV (6)	55	294.3	425 mW
DGK (8)	54.2	259.9	481 mW
DGS (10)	54.1	257.7	485 mW
N (14, 16)	32	78	1600 mW
P (8)	41	104	1200 mW
PW (14)	29.3	173.6	720 mW
PW (16)	28.7	161.4	774 mW

recommended operating conditions

		MIN	MAX	UNIT
Supply voltage, V_{DD}	Single supply	2.7	6	V
	Split supply	± 1.35	± 3	
Common-mode input voltage range, V_{ICR}		V_{DD-}	V_{DD+}	V
Operating free-air temperature, T_A	C-suffix	0	70	°C
	I-suffix	-40	125	



TLV2450, TLV2451, TLV2452, TLV2453, TLV2454, TLV2455, TLV245xA
FAMILY OF 23- μ A 220-KHz RAIL-TO-RAIL INPUT/OUTPUT
OPERATIONAL AMPLIFIERS WITH SHUTDOWN

SLOS218B – DECEMBER 1998 – REVISED JUNE 1999

electrical characteristics at specified free-air temperature, $V_{DD} = 3$ V (unless otherwise noted)

PARAMETER		TEST CONDITIONS		T_A^\dagger	MIN	TYP	MAX	UNIT					
V_{IO}	Input offset voltage	TLV245x	$V_{DD} = \pm 1.5$ V $V_{IC} = 0,$	$V_O = 0,$ $R_S = 50 \Omega$	25°C	20	1500	μ V					
					Full range		2000						
		TLV245xA			25°C	20	1000						
					Full range		1300						
α_{VIO}	Temperature coefficient of input offset voltage				0.3		μ V/°C						
I_{IO}	Input offset current				25°C	0.3	4.5	nA					
					Full range		5.5						
I_{IB}	Input bias current				25°C	0.9	5	nA					
					Full range		7						
V_{ICR}	Common-mode input voltage range	CMRR > 70 dB	$R_S = 50 \Omega$	25°C	0 to 3		V						
		CMRR > 52 dB	$R_S = 50 \Omega$	Full range	0 to 3								
V_{OH}	High-level output voltage	$V_{IC} = 1.5$ V,	$I_{OH} = -500 \mu$ A		25°C	2.85	2.95	V					
					Full range	2.83							
V_{OL}	Low-level output voltage				$V_{IC} = 1.5$ V,	$I_{OL} = 500 \mu$ A		25°C	0.09	0.16	V		
								Full range		0.2			
I_{OS}	Short-circuit output current	Sourcing						25°C	4	12	mA		
								Full range	3				
		Sinking			25°C	2	7						
					Full range	1							
I_O	Output current	$V_O = 0.5$ V from rail		25°C		± 4	mA						
A_{VD}	Large-signal differential voltage amplification	$V_{O(PP)} = 1$ V,	$R_L = 10$ k Ω		25°C	96	110	dB					
					Full range	91							
$r_{i(d)}$	Differential input resistance						25°C		10^9	Ω			
C_{IC}	Common-mode input capacitance				$f = 10$ kHz		25°C		4.5	pF			
z_o	Closed-loop output impedance	$f = 10$ kHz,	$A_V = 10$	25°C		80	Ω						
CMRR	Common-mode rejection ratio	$V_{IC} = 0$ to 3 V, $R_S = 50 \Omega$			Full range	TLV245xC	60	dB					
						TLV245xI	52						
k_{SVR}	Supply voltage rejection ratio ($\Delta V_{DD} / \Delta V_{IO}$)					$V_{DD} = 2.7$ V to 6 V, No load	$V_{IC} = V_{DD}/2,$			25°C	76	89	dB
										Full range	74		
		$V_{DD} = 3$ V to 5 V, No load	25°C	88	106								
			Full range	84									

† Full range is 0°C to 70°C for C suffix and -40°C to 125°C for I suffix.



TLV2450, TLV2451, TLV2452, TLV2453, TLV2454, TLV2455, TLV245xA
FAMILY OF 23- μ A 220-kHz RAIL-TO-RAIL INPUT/OUTPUT
OPERATIONAL AMPLIFIERS WITH SHUTDOWN

SLOS218B – DECEMBER 1998 – REVISED JUNE 1999

electrical characteristics at specified free-air temperature, $V_{DD} = 3$ V (unless otherwise noted)
(continued)

PARAMETER		TEST CONDITIONS		T_A †	MIN	TYP	MAX	UNIT
I_{DD}	Supply current (per channel)	$V_O = 1.5$ V, No load		25°C		23	35	μ A
			TLV245xC	Full range			40	
			TLV245xI	Full range				
$V_{(ON)}$	Turnon voltage level	$A_V = 1$		25°C		1.73		V
$V_{(OFF)}$	Turnoff voltage level	$A_V = 1$		25°C		1.45		V
$I_{DD}(SHDN)$	Supply current in shutdown mode (TLV2450, TLV2453, TLV2455) (per channel)	$\overline{SHDN} = < 1.45$ V		25°C		12	70	nA
			TLV245xC	Full range			70	
			TLV245xI	Full range				

† Full range is 0°C to 70°C for C suffix and –40°C to 125°C for I suffix.

operating characteristics at specified free-air temperature, $V_{DD} = 3$ V (unless otherwise noted)

PARAMETER		TEST CONDITIONS		T_A †	MIN	TYP	MAX	UNIT
SR	Slew rate at unity gain	$V_{O(PP)} = 0.8$ V, $R_L = 10$ k Ω	$C_L = 150$ pF,	25°C	0.05	0.11		V/ μ s
				Full range	0.02			
V_n	Equivalent input noise voltage	$f = 100$ Hz		25°C		49		nV/ $\sqrt{\text{Hz}}$
				25°C		51		
I_n	Equivalent input noise current	$f = 1$ kHz		25°C		3.5		pA/ $\sqrt{\text{Hz}}$
THD + N	Total harmonic distortion plus noise	$V_{O(PP)} = 1.5$ V, $R_L = 10$ k Ω , $f = 1$ kHz		$A_V = 1$	25°C	0.04%		
				$A_V = 10$		0.3%		
				$A_V = 100$		1.5%		
$t_{(on)}$	Amplifier turnon time	$A_V = 5$,	$R_L = \text{OPEN}$,	25°C		59		μ s
$t_{(off)}$	Amplifier turnoff time	Measured at 50% point		25°C		836		ns
	Gain-bandwidth product	$f = 10$ kHz,	$R_L = 10$ k Ω	25°C		200		kHz
t_s	Settling time	$V_{(STEP)PP} = 2$ V, $A_V = -1$, $C_L = 10$ pF, $R_L = 10$ k Ω		0.1%	25°C	26	μ s	
				0.01%		31		
		$V_{(STEP)PP} = 2$ V, $A_V = -1$, $C_L = 56$ pF, $R_L = 10$ k Ω		0.1%		26		
				0.01%		31		
ϕ_m	Phase margin	$R_L = 10$ k Ω ,	$C_L = 1000$ pF	25°C		56°		
	Gain margin	$R_L = 10$ k Ω ,	$C_L = 1000$ pF	25°C		7		dB

† Full range is 0°C to 70°C for C suffix and –40°C to 125°C for I suffix.



TLV2450, TLV2451, TLV2452, TLV2453, TLV2454, TLV2455, TLV245xA
FAMILY OF 23- μ A 220-KHz RAIL-TO-RAIL INPUT/OUTPUT
OPERATIONAL AMPLIFIERS WITH SHUTDOWN

SLOS218B – DECEMBER 1998 – REVISED JUNE 1999

electrical characteristics at specified free-air temperature, $V_{DD} = 5$ V (unless otherwise noted)

PARAMETER		TEST CONDITIONS		T_A^\dagger	MIN	TYP	MAX	UNIT
V_{IO}	Input offset voltage	TLV245x	$V_{DD} = \pm 2.5$ V $V_{IC} = 0,$ $V_O = 0,$ $R_S = 50 \Omega$	25°C	20	1500		μ V
				Full range		2000		
		TLV245xA		25°C	20	1000		
				Full range		1300		
α_{VIO}	Temperature coefficient of input offset voltage				0.3		μ V/°C	
I_{IO}	Input offset current			25°C	0.3	4.5		nA
				Full range		5.5		
I_{IB}	Input bias current			25°C	0.5	5		nA
				Full range		7		
V_{ICR}	Common-mode input voltage range	CMRR > 70 dB	$R_S = 50 \Omega$	25°C	0 to 5			V
		CMRR > 52 dB	$R_S = 50 \Omega$	Full range	0 to 5			
V_{OH}	High-level output voltage	$V_{IC} = 2.5$ V,	$I_{OH} = -500 \mu$ A	25°C	4.87	4.97		V
				Full range	4.85			
V_{OL}	Low-level output voltage	$V_{IC} = 2.5$ V,	$I_{OL} = 500 \mu$ A	25°C	0.07	0.15		V
				Full range		0.16		
I_{OS}	Short-circuit output current	Sourcing		25°C	20	32		mA
				Full range	18			
		Sinking		25°C	12	18		
				Full range	10			
I_O	Output current	$V_O = 0.5$ V from rail		25°C	± 10		mA	
A_{VD}	Large-signal differential voltage amplification	$V_{O(PP)} = 3$ V,	$R_L = 10$ k Ω	25°C	96	103		dB
				Full range	91			
$r_{i(d)}$	Differential input resistance			25°C		10^9		Ω
C_{IC}	Common-mode input capacitance	$f = 10$ kHz		25°C		4.5		pF
z_o	Closed-loop output impedance	$f = 10$ kHz,	$A_V = 10$	25°C		45		Ω
CMRR	Common-mode rejection ratio	$V_{IC} = 0$ to 5 V, $R_S = 50 \Omega$	TLV245xC	Full range	66			dB
			TLV245xI		52			
k_{SVR}	Supply voltage rejection ratio ($\Delta V_{DD} / \Delta V_{IO}$)	$V_{DD} = 2.7$ V to 6 V, No load	$V_{IC} = V_{DD}/2,$	25°C	76	89		dB
				Full range	74			
		$V_{DD} = 3$ V to 5 V, No load	$V_{IC} = V_{DD}/2,$	25°C	88	106		
				Full range	84			

† Full range is 0°C to 70°C for C suffix and -40°C to 125°C for I suffix.

TLV2450, TLV2451, TLV2452, TLV2453, TLV2454, TLV2455, TLV245xA
FAMILY OF 23- μ A 220-kHz RAIL-TO-RAIL INPUT/OUTPUT
OPERATIONAL AMPLIFIERS WITH SHUTDOWN

SLOS218B – DECEMBER 1998 – REVISED JUNE 1999

electrical characteristics at specified free-air temperature, $V_{DD} = 5$ V (unless otherwise noted)
(continued)

PARAMETER		TEST CONDITIONS		T_A †	MIN	TYP	MAX	UNIT
I_{DD}	Supply current (per channel)	$V_O = 2.5$ V, No load		25°C		23	42	μ A
			TLV245xC	Full range			44	
			TLV245xI	Full range				
$V_{(ON)}$	Turnon voltage level	$A_V = 1$		25°C		1.73		V
$V_{(OFF)}$	Turnoff voltage level	$A_V = 1$		25°C		1.45		V
$I_{DD}(SHDN)$	Supply current in shutdown mode (TLV2450, TLV2453, TLV2455) (per channel)	$\overline{SHDN} = < 1.45$ V		25°C		16	65	nA
			TLV245xC	Full range			65	
			TLV245xI	Full range				

† Full range is 0°C to 70°C for C suffix and –40°C to 125°C for I suffix.

operating characteristics at specified free-air temperature, $V_{DD} = 5$ V (unless otherwise noted)

PARAMETER		TEST CONDITIONS		T_A †	MIN	TYP	MAX	UNIT
SR	Slew rate at unity gain	$V_{O(PP)} = 2$ V, $R_L = 10$ k Ω	$C_L = 150$ pF,	25°C	0.05	0.11		V/ μ s
				Full range	0.02			
V_n	Equivalent input noise voltage	$f = 100$ Hz		25°C		49		nV/ $\sqrt{\text{Hz}}$
				25°C		52		
I_n	Equivalent input noise current	$f = 1$ kHz		25°C		3.5		pA/ $\sqrt{\text{Hz}}$
THD + N	Total harmonic distortion plus noise	$V_{O(PP)} = 3$ V, $R_L = 10$ k Ω , $f = 1$ kHz		$A_V = 1$	25°C	0.02%		
				$A_V = 10$		0.18%		
				$A_V = 100$		0.9%		
$t_{(on)}$	Amplifier turnon time	$A_V = 5$,	$R_L = \text{OPEN}$,	25°C		59		μ s
$t_{(off)}$	Amplifier turnoff time	Measured at 50% point		25°C		836		ns
	Gain-bandwidth product	$f = 10$ kHz,	$R_L = 10$ k Ω	25°C		220		kHz
t_s	Settling time	$V_{(STEP)PP} = 2$ V, $A_V = -1$, $C_L = 10$ pF, $R_L = 10$ k Ω		0.1%	25°C	24		μ s
				0.01%		30		
		$V_{(STEP)PP} = 2$ V, $A_V = -1$, $C_L = 56$ pF, $R_L = 10$ k Ω		0.1%		25		
				0.01%		30		
ϕ_m	Phase margin	$R_L = 10$ k Ω ,	$C_L = 1000$ pF	25°C		56°		
	Gain margin	$R_L = 10$ k Ω ,	$C_L = 1000$ pF	25°C		7		dB

† Full range is 0°C to 70°C for C suffix and –40°C to 125°C for I suffix.



TLV2450, TLV2451, TLV2452, TLV2453, TLV2454, TLV2455, TLV245xA
FAMILY OF 23- μ A 220-KHz RAIL-TO-RAIL INPUT/OUTPUT
OPERATIONAL AMPLIFIERS WITH SHUTDOWN

SLOS218B – DECEMBER 1998 – REVISED JUNE 1999

TYPICAL CHARACTERISTICS

Table of Graphs

		FIGURE	
V_{IO}	Input offset voltage	vs Common-mode input voltage	1, 2
I_{IO}	Input offset current	vs Common-mode input voltage vs Free-air temperature	3, 4 7, 8
I_{IB}	Input bias current	vs Common-mode input voltage vs Free-air temperature	5, 6 7, 8
A_{VD}	Differential voltage amplification	vs Frequency	9, 10
	Phase	vs Frequency	9, 10
V_{OL}	Low-level output voltage	vs Low-level output current	11, 13
V_{OH}	High-level output voltage	vs High-level output current	12, 14
Z_o	Output impedance	vs Frequency	15, 16
CMRR	Common-mode rejection ratio	vs Frequency	17
PSRR	Power supply rejection ratio	vs Frequency	18
I_{DD}	Supply current	vs Supply voltage	19
I_{DD}	Supply current	vs Free-air temperature	20
V_n	Equivalent input noise voltage	vs Frequency	21
THD + N	Total harmonic distortion plus noise	vs Frequency	22, 23
ϕ_m	Phase margin	vs Load capacitance	24
	Gain-bandwidth product	vs Supply voltage	25
SR	Slew rate	vs Supply voltage vs Free-air temperature	26 27
$V_{O(PP)}$	Maximum peak-to-peak output voltage	vs Frequency	28
	Crosstalk	vs Frequency	29, 30
	Small-signal follower pulse response	vs Time	31, 33
	Large-signal follower pulse response	vs Time	32, 34
	Shutdown on supply current	vs Time	35
	Shutdown off supply current	vs Time	36
	Shutdown supply current	vs Free-air temperature	37
	Shutdown supply current	vs Time	38 – 41
	Shutdown pulse	vs Time	38 – 41
	Shutdown off pulse response	vs Time	42, 43
	Shutdown on pulse response	vs Time	44, 45
	Shutdown reverse isolation	vs Frequency	46
	Shutdown forward isolation	vs Frequency	47



TLV2450, TLV2451, TLV2452, TLV2453, TLV2454, TLV2455, TLV245xA
 FAMILY OF 23- μ A 220-kHz RAIL-TO-RAIL INPUT/OUTPUT
 OPERATIONAL AMPLIFIERS WITH SHUTDOWN

SLOS218B – DECEMBER 1998 – REVISED JUNE 1999

TYPICAL CHARACTERISTICS

INPUT OFFSET VOLTAGE
 vs
 COMMON-MODE INPUT VOLTAGE

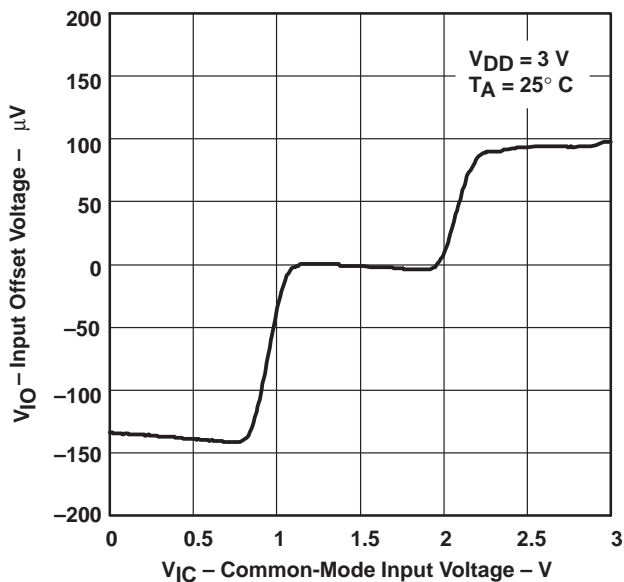

Figure 1

INPUT OFFSET VOLTAGE
 vs
 COMMON-MODE INPUT VOLTAGE

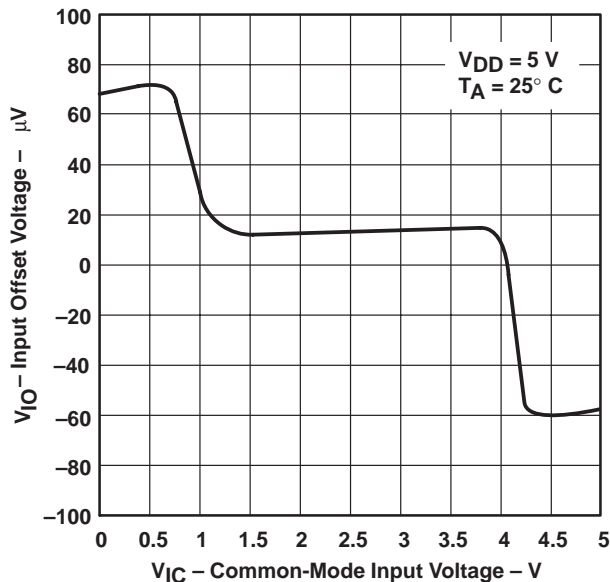

Figure 2

INPUT OFFSET CURRENT
 vs
 COMMON-MODE INPUT VOLTAGE

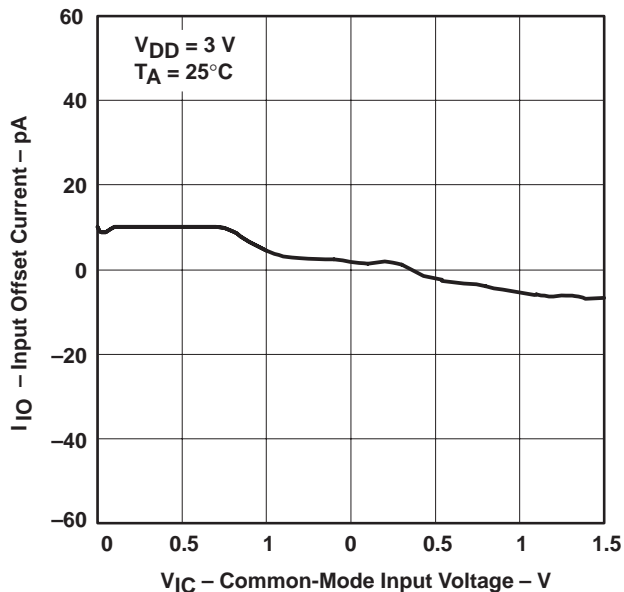

Figure 3

INPUT OFFSET CURRENT
 vs
 COMMON-MODE INPUT VOLTAGE

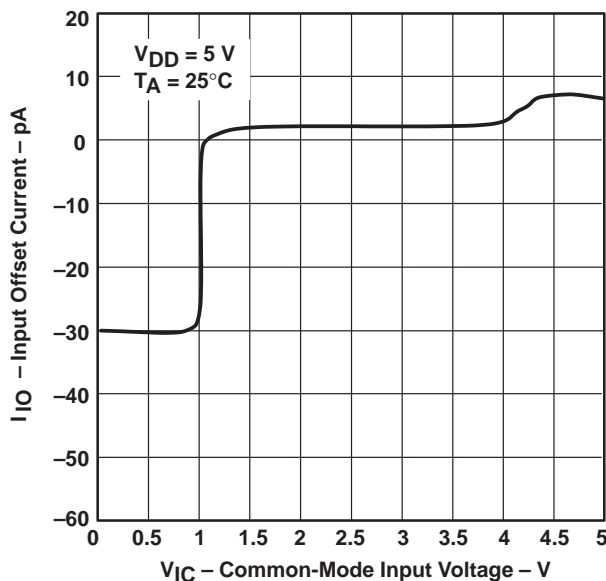
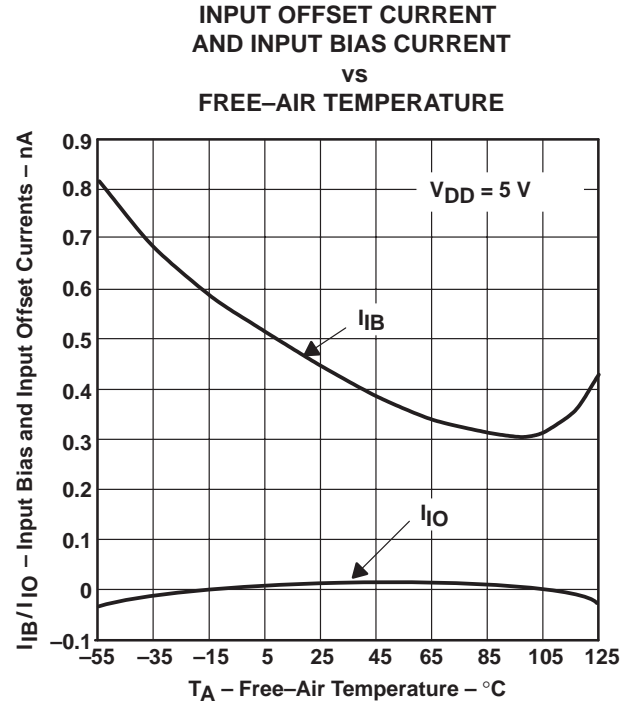
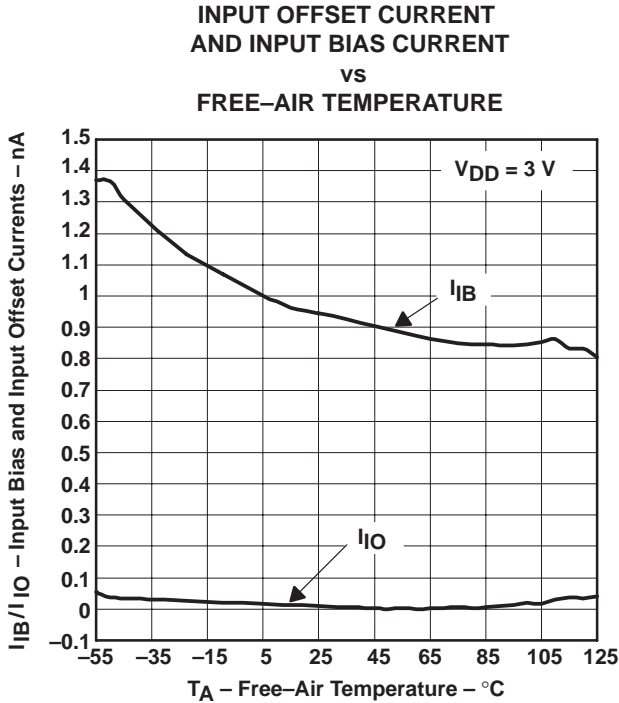
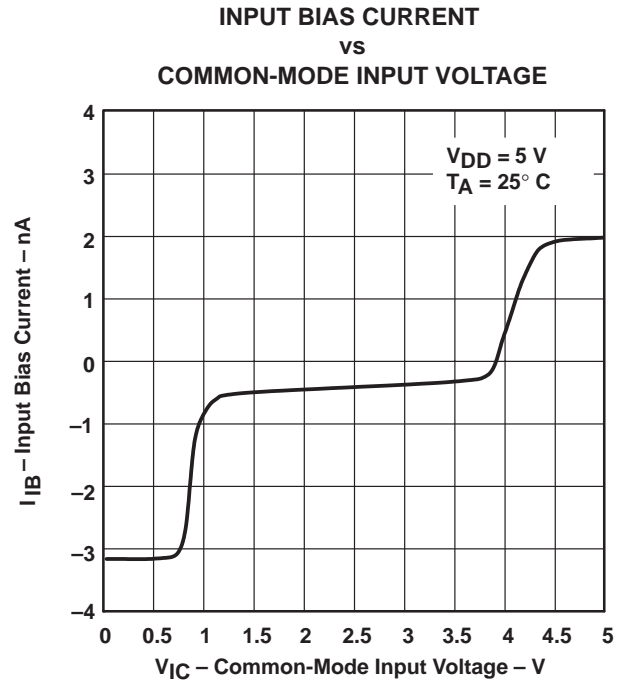
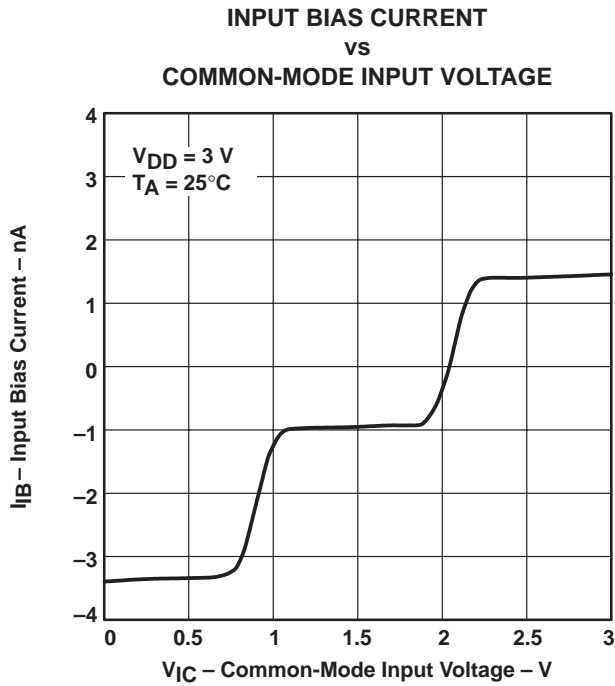

Figure 4



TYPICAL CHARACTERISTICS



TLV2450, TLV2451, TLV2452, TLV2453, TLV2454, TLV2455, TLV245xA
FAMILY OF 23- μ A 220-kHz RAIL-TO-RAIL INPUT/OUTPUT
OPERATIONAL AMPLIFIERS WITH SHUTDOWN

SLOS218B – DECEMBER 1998 – REVISED JUNE 1999

TYPICAL CHARACTERISTICS

DIFFERENTIAL VOLTAGE AMPLIFICATION AND PHASE
vs
FREQUENCY

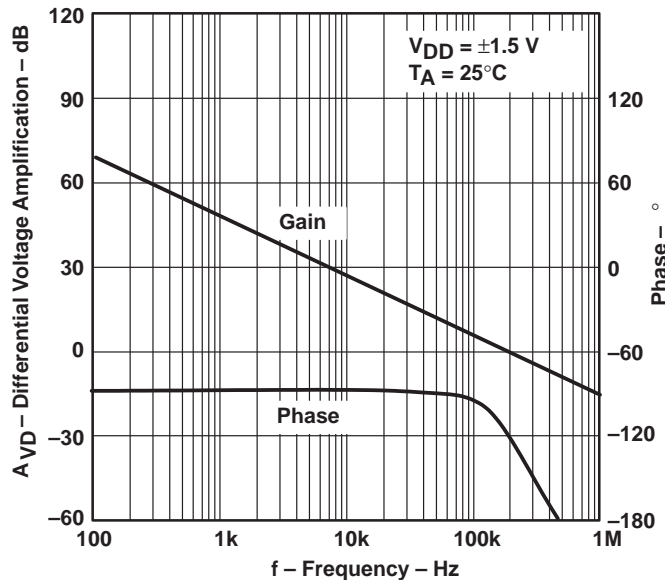

Figure 9

DIFFERENTIAL VOLTAGE AMPLIFICATION AND PHASE
vs
FREQUENCY

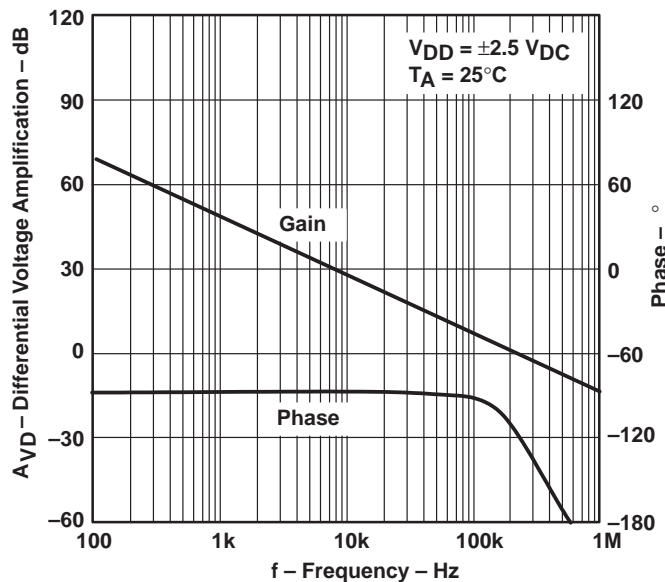

Figure 10



TLV2450, TLV2451, TLV2452, TLV2453, TLV2454, TLV2455, TLV245xA
 FAMILY OF 23- μ A 220-KHz RAIL-TO-RAIL INPUT/OUTPUT
 OPERATIONAL AMPLIFIERS WITH SHUTDOWN

SLOS218B – DECEMBER 1998 – REVISED JUNE 1999

TYPICAL CHARACTERISTICS

LOW-LEVEL OUTPUT VOLTAGE
 vs
 LOW-LEVEL OUTPUT CURRENT

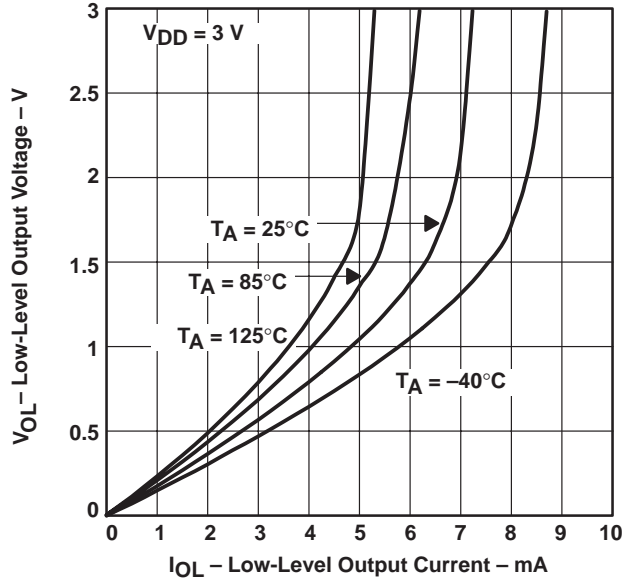

Figure 11

HIGH-LEVEL OUTPUT VOLTAGE
 vs
 HIGH-LEVEL OUTPUT CURRENT

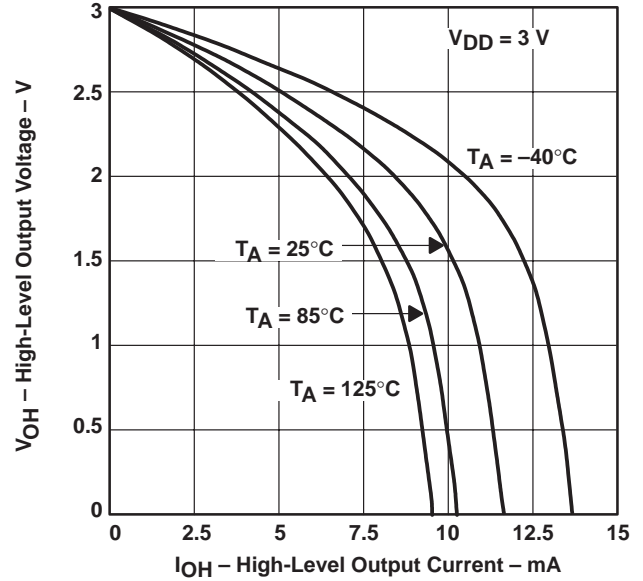

Figure 12

LOW-LEVEL OUTPUT VOLTAGE
 vs
 LOW-LEVEL OUTPUT CURRENT

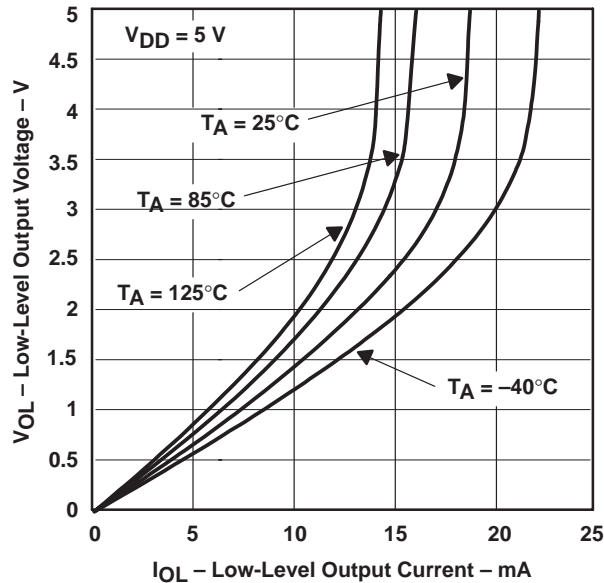

Figure 13

HIGH-LEVEL OUTPUT VOLTAGE
 vs
 HIGH-LEVEL OUTPUT CURRENT

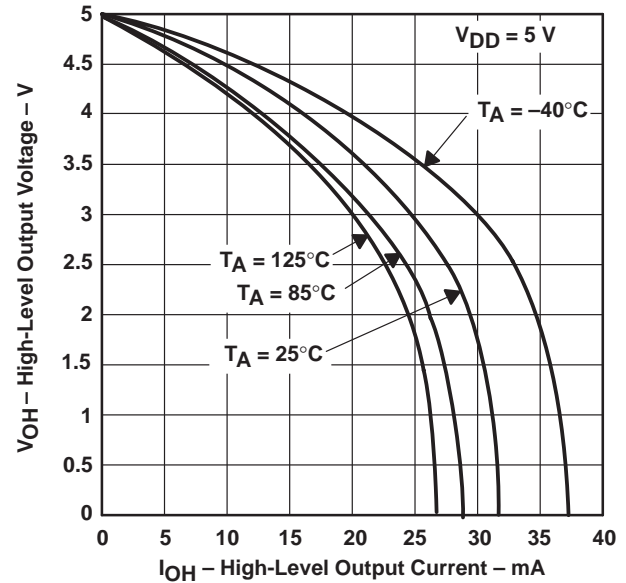

Figure 14

TLV2450, TLV2451, TLV2452, TLV2453, TLV2454, TLV2455, TLV245xA
FAMILY OF 23- μ A 220-kHz RAIL-TO-RAIL INPUT/OUTPUT
OPERATIONAL AMPLIFIERS WITH SHUTDOWN

SLOS218B – DECEMBER 1998 – REVISED JUNE 1999

TYPICAL CHARACTERISTICS

**OUTPUT IMPEDANCE
vs
FREQUENCY**

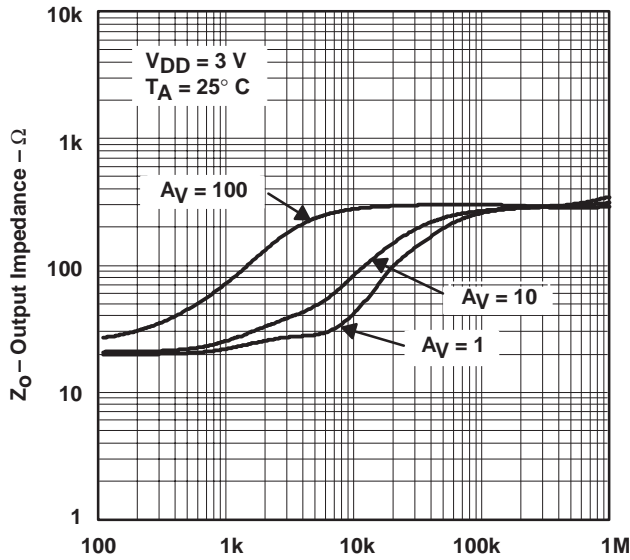

Figure 15

**OUTPUT IMPEDANCE
vs
FREQUENCY**

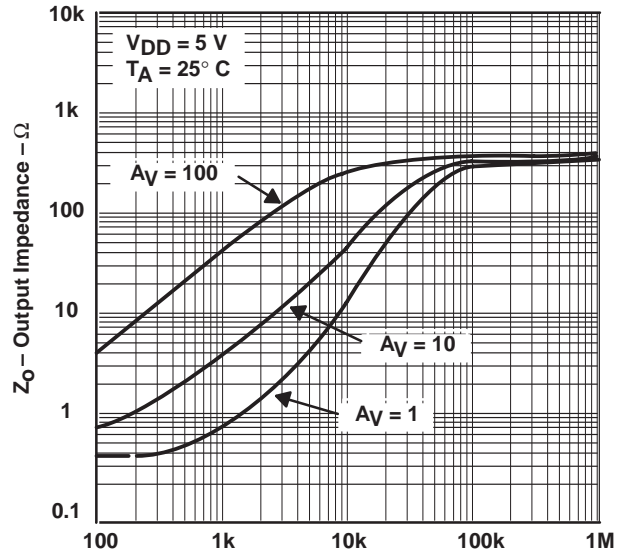

Figure 16

**COMMON-MODE REJECTION RATIO
vs
FREQUENCY**

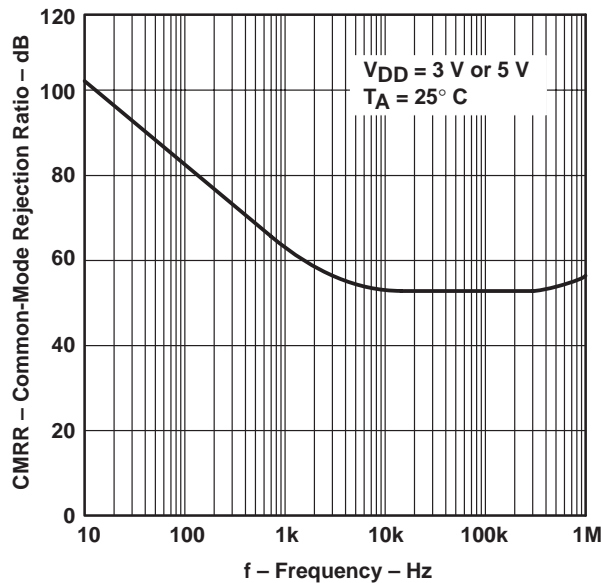

Figure 17



TLV2450, TLV2451, TLV2452, TLV2453, TLV2454, TLV2455, TLV245xA
 FAMILY OF 23- μ A 220-KHz RAIL-TO-RAIL INPUT/OUTPUT
 OPERATIONAL AMPLIFIERS WITH SHUTDOWN

SLOS218B – DECEMBER 1998 – REVISED JUNE 1999

TYPICAL CHARACTERISTICS

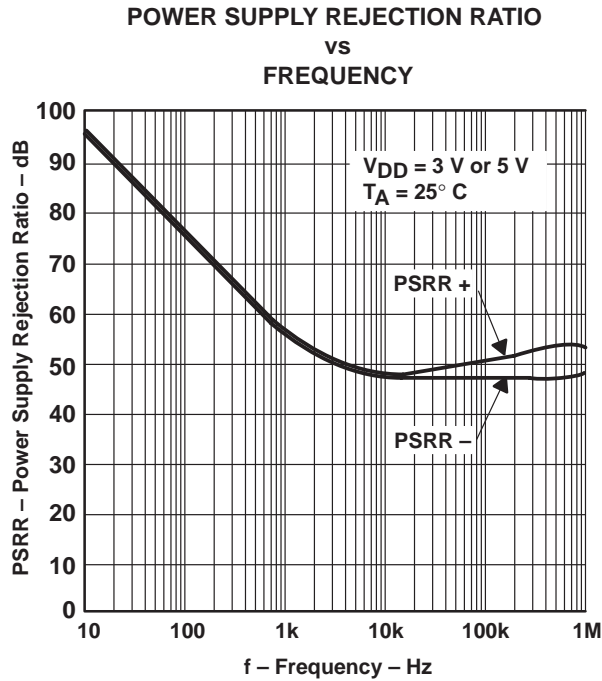

Figure 18

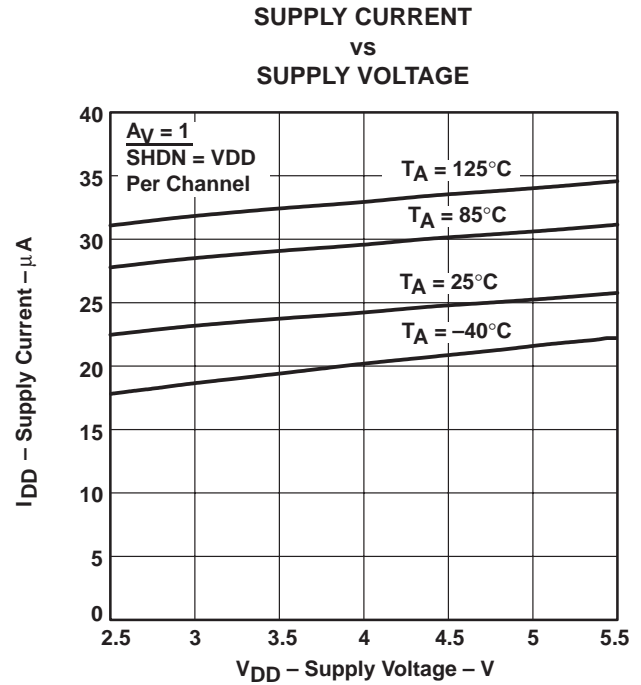

Figure 19

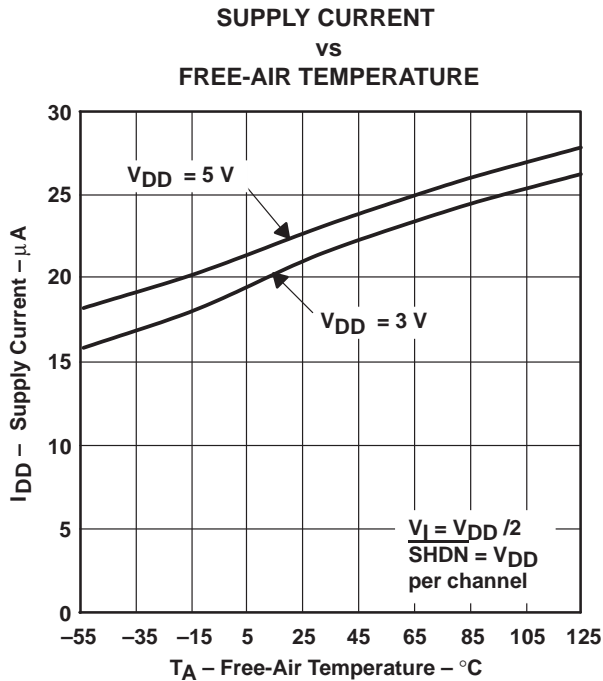

Figure 20

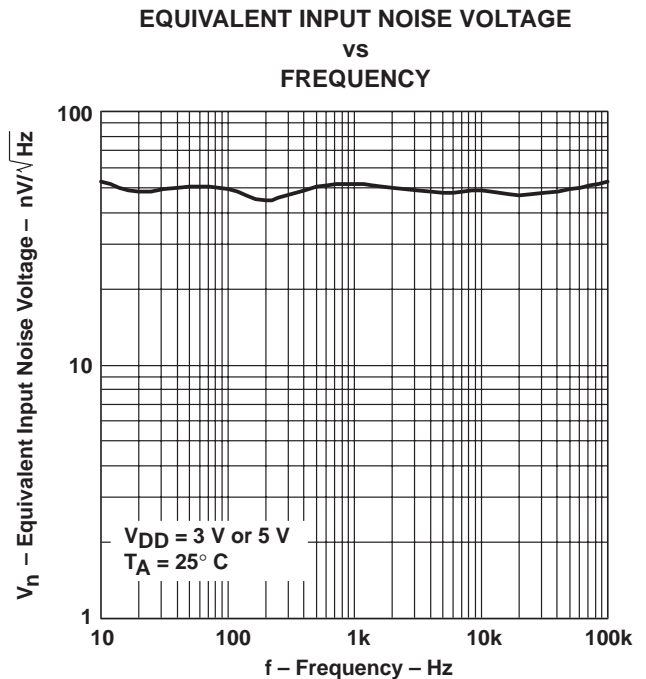

Figure 21



TLV2450, TLV2451, TLV2452, TLV2453, TLV2454, TLV2455, TLV245xA
FAMILY OF 23- μ A 220-kHz RAIL-TO-RAIL INPUT/OUTPUT
OPERATIONAL AMPLIFIERS WITH SHUTDOWN

SLOS218B – DECEMBER 1998 – REVISED JUNE 1999

TYPICAL CHARACTERISTICS

TOTAL HARMONIC DISTORTION PLUS NOISE
VS
FREQUENCY

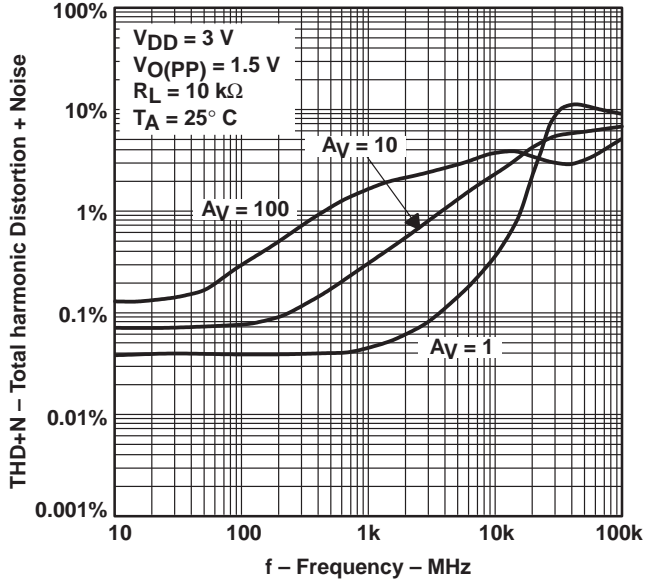

Figure 22

TOTAL HARMONIC DISTORTION PLUS NOISE
VS
FREQUENCY

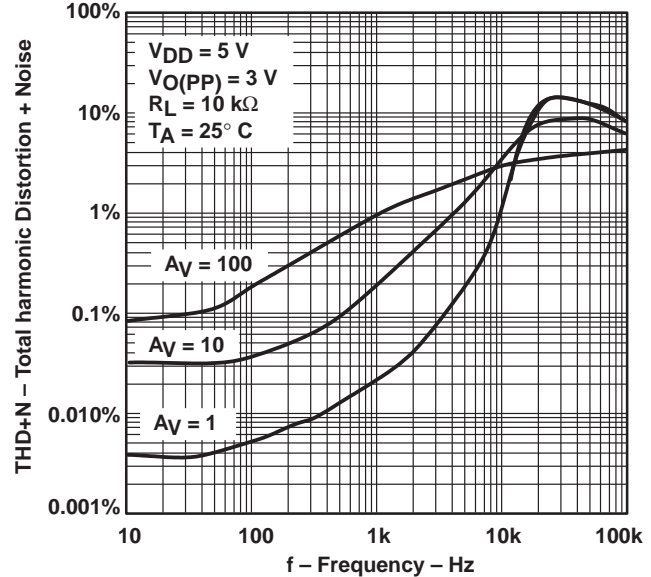

Figure 23

PHASE MARGIN
VS
LOAD CAPACITANCE

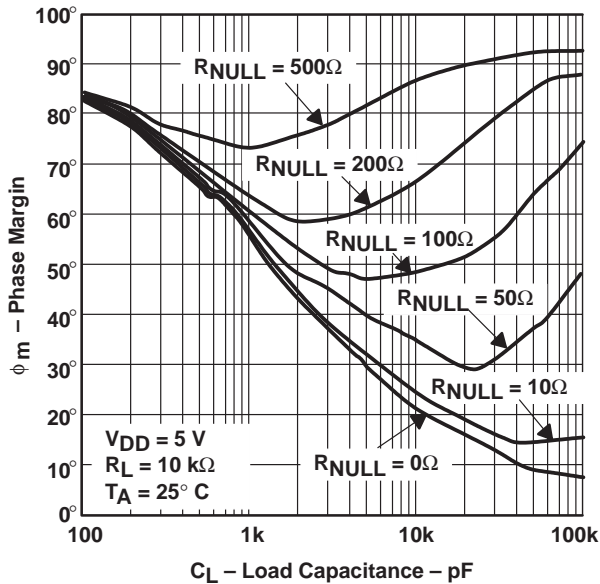

Figure 24

GAIN BANDWIDTH PRODUCT
VS
SUPPLY VOLTAGE

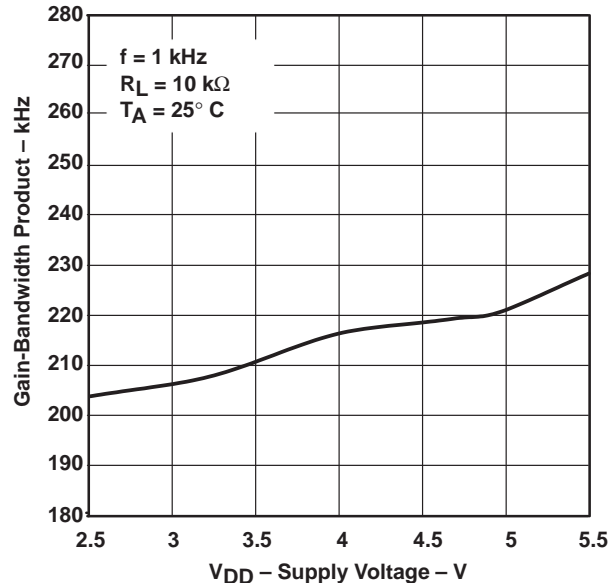

Figure 25



TYPICAL CHARACTERISTICS

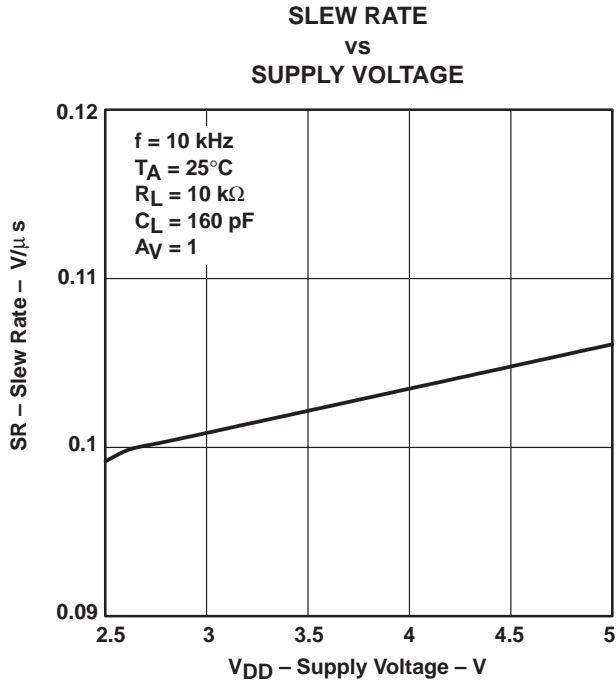

Figure 26

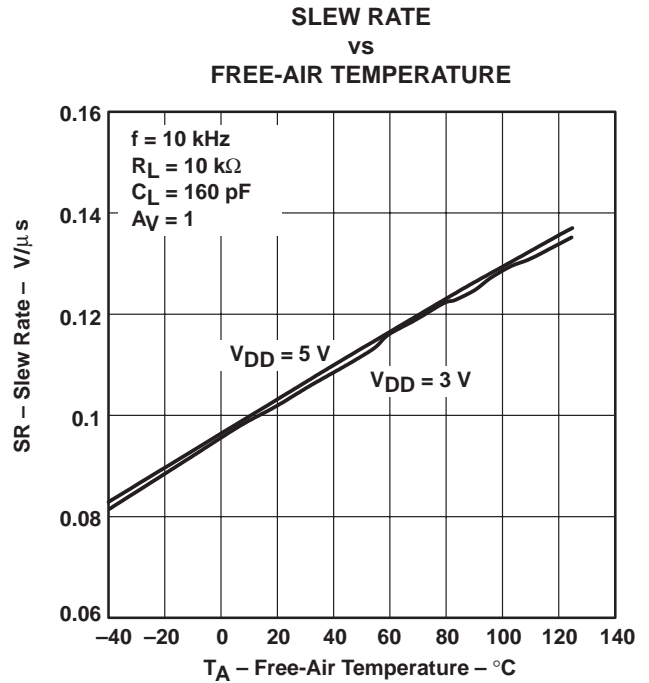

Figure 27

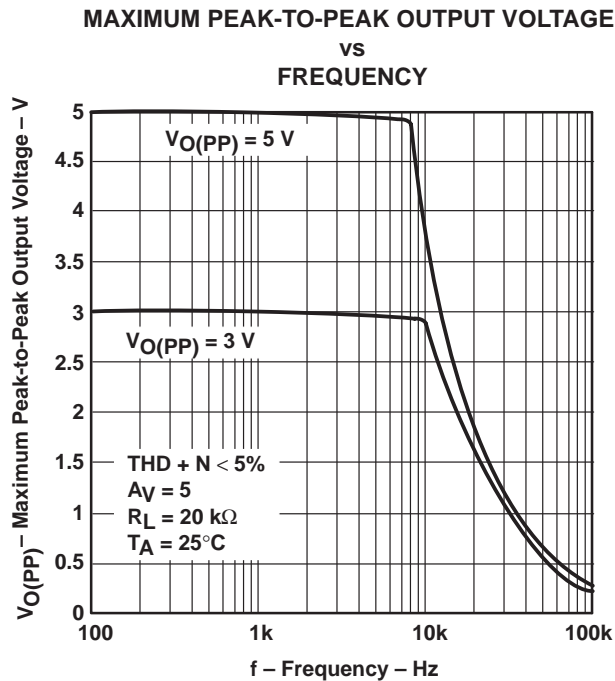

Figure 28

TLV2450, TLV2451, TLV2452, TLV2453, TLV2454, TLV2455, TLV245xA
FAMILY OF 23- μ A 220-kHz RAIL-TO-RAIL INPUT/OUTPUT
OPERATIONAL AMPLIFIERS WITH SHUTDOWN

SLOS218B – DECEMBER 1998 – REVISED JUNE 1999

TYPICAL CHARACTERISTICS

CROSSTALK
vs
FREQUENCY

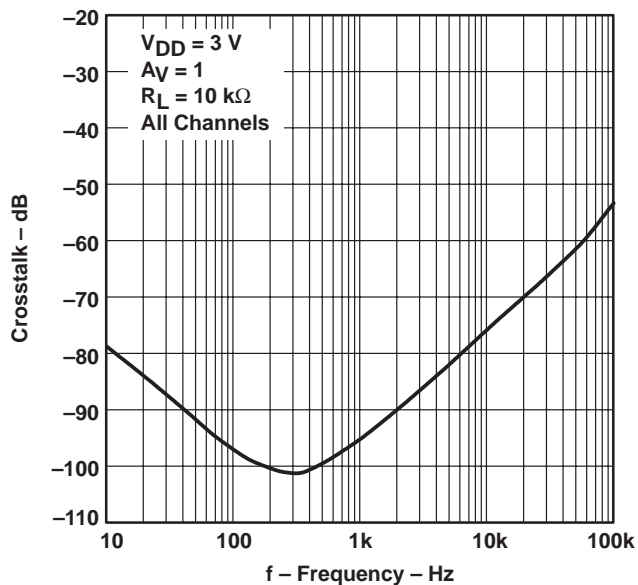

Figure 29

CROSSTALK
vs
FREQUENCY

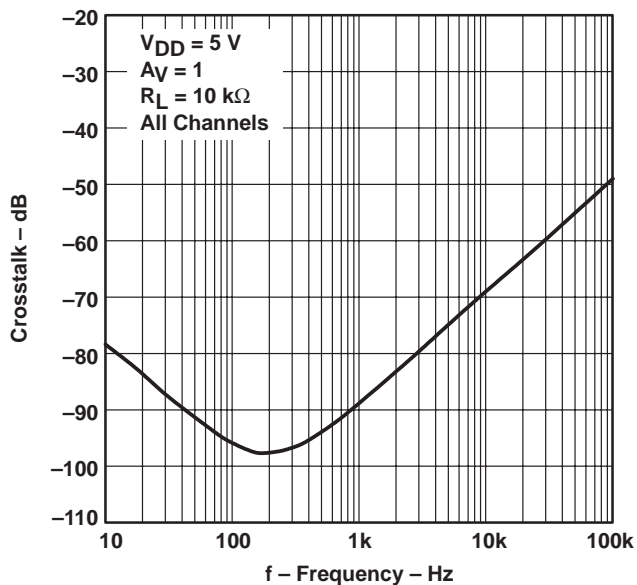

Figure 30

SMALL-SIGNAL FOLLOWER PULSE RESPONSE
vs
TIME

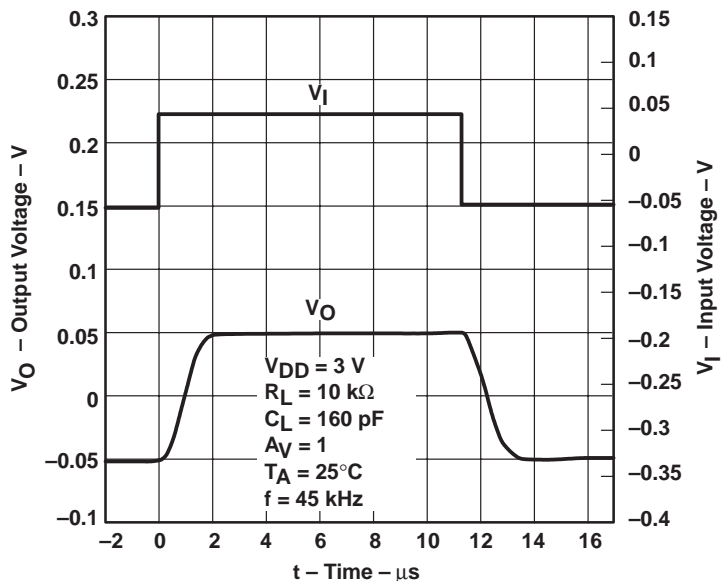

Figure 31



TYPICAL CHARACTERISTICS

LARGE-SIGNAL FOLLOWER PULSE RESPONSE
 vs
 TIME

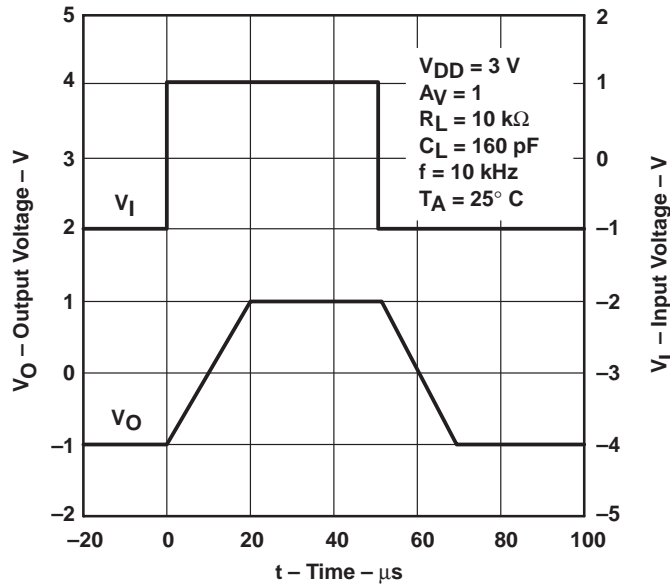

Figure 32

SMALL-SIGNAL FOLLOWER PULSE RESPONSE
 vs
 TIME

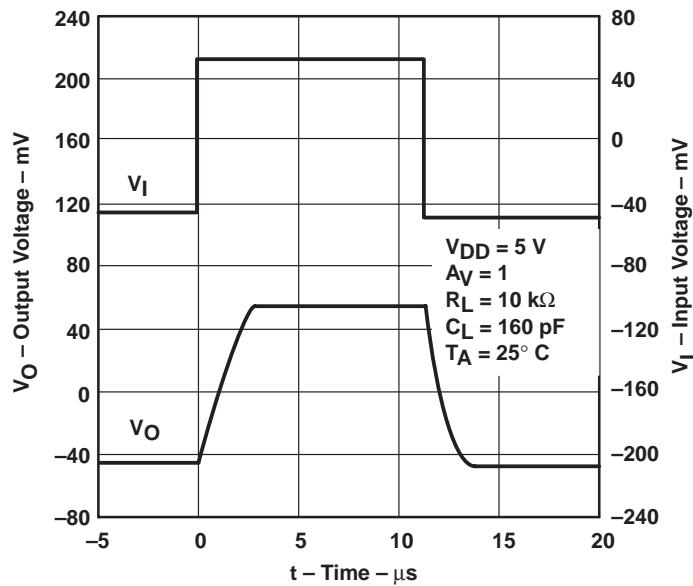

Figure 33

TLV2450, TLV2451, TLV2452, TLV2453, TLV2454, TLV2455, TLV245xA
 FAMILY OF 23- μ A 220-kHz RAIL-TO-RAIL INPUT/OUTPUT
 OPERATIONAL AMPLIFIERS WITH SHUTDOWN

SLOS218B – DECEMBER 1998 – REVISED JUNE 1999

TYPICAL CHARACTERISTICS

LARGE-SIGNAL FOLLOWER PULSE RESPONSE
 vs
 TIME

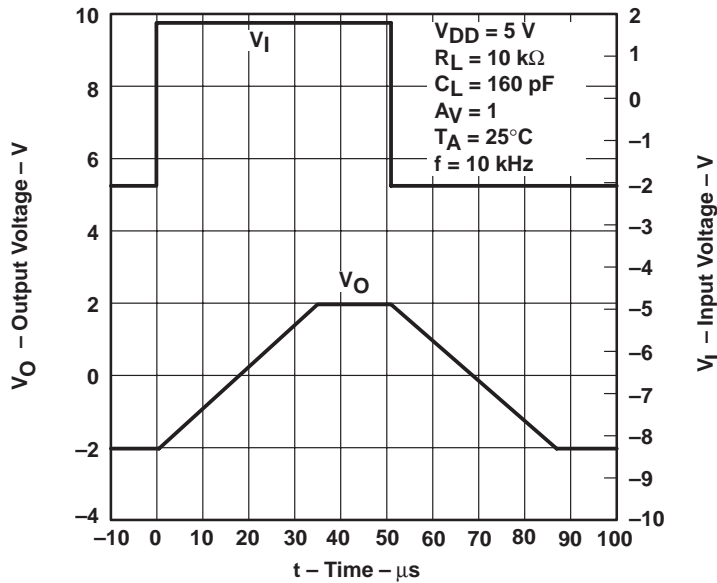

Figure 34

SHUTDOWN ON SUPPLY CURRENT
 vs
 TIME

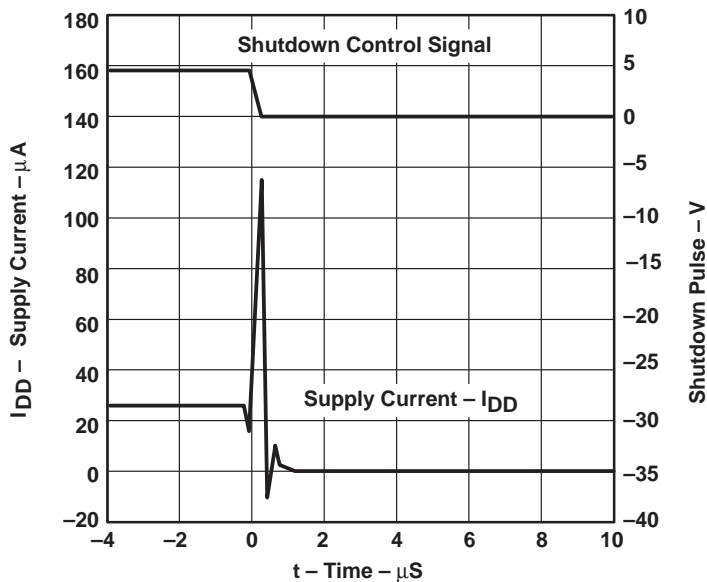

Figure 35



TYPICAL CHARACTERISTICS

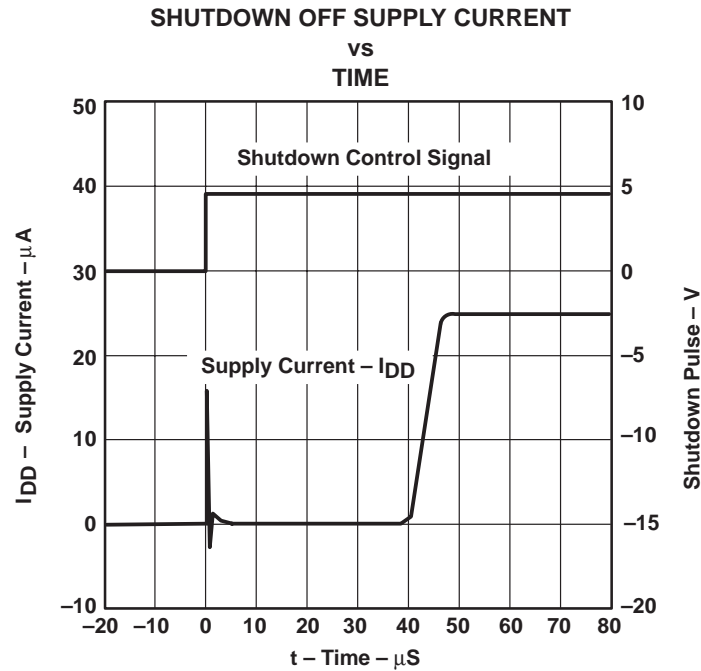

Figure 36

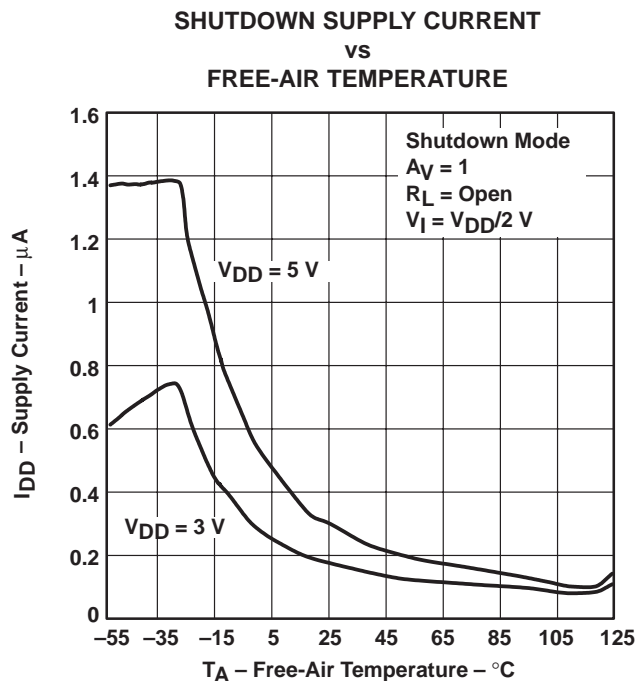

Figure 37

TLV2450, TLV2451, TLV2452, TLV2453, TLV2454, TLV2455, TLV245xA
FAMILY OF 23- μ A 220-kHz RAIL-TO-RAIL INPUT/OUTPUT
OPERATIONAL AMPLIFIERS WITH SHUTDOWN

SLOS218B – DECEMBER 1998 – REVISED JUNE 1999

TYPICAL CHARACTERISTICS

SHUTDOWN SUPPLY CURRENT AND SHUTDOWN PULSE
vs
TIME

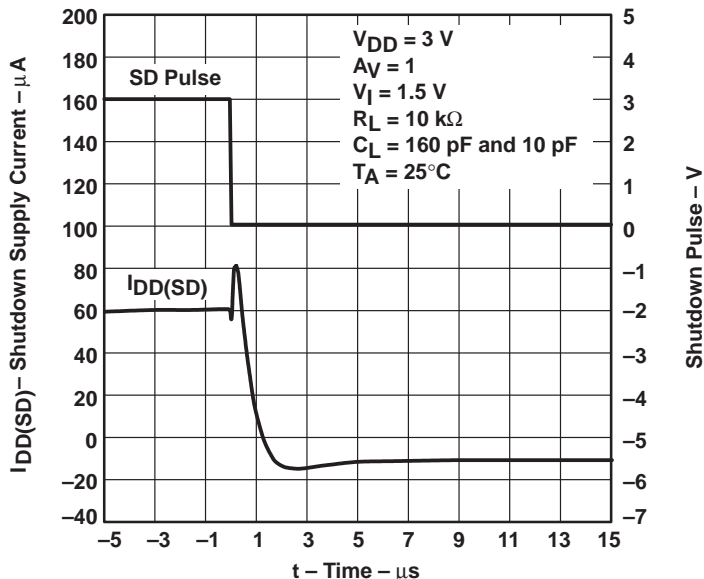

Figure 38

SHUTDOWN SUPPLY CURRENT AND SHUTDOWN PULSE
vs
TIME

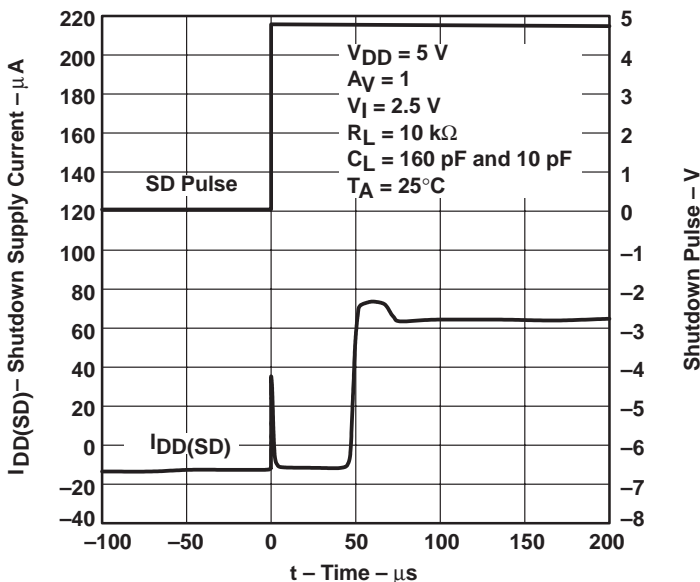

Figure 39

TYPICAL CHARACTERISTICS

SHUTDOWN SUPPLY CURRENT AND SHUTDOWN PULSE
 vs
 TIME

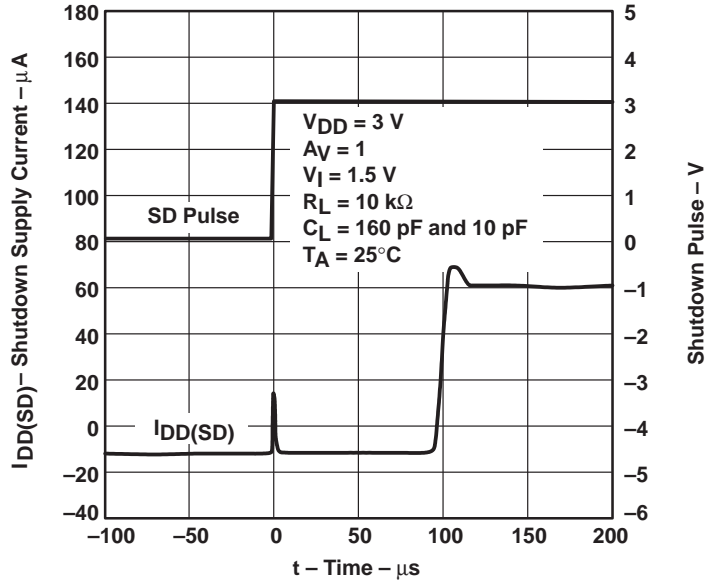

Figure 40

SHUTDOWN SUPPLY CURRENT AND SHUTDOWN PULSE
 vs
 TIME

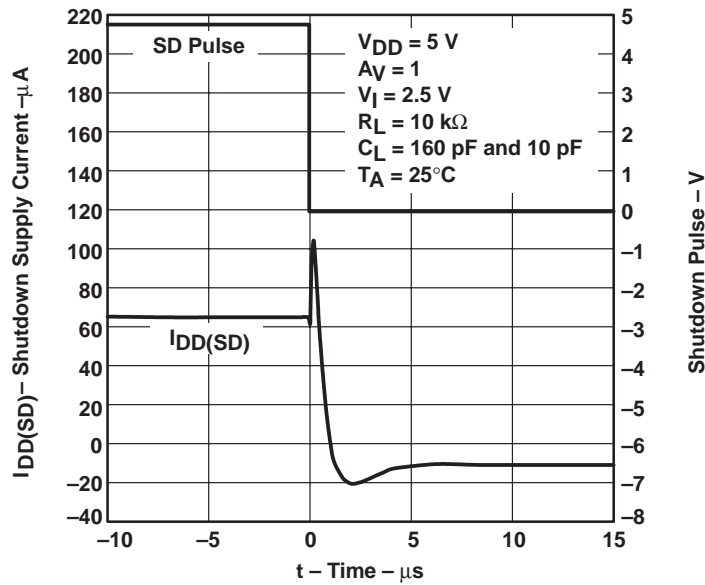

Figure 41

TLV2450, TLV2451, TLV2452, TLV2453, TLV2454, TLV2455, TLV245xA
FAMILY OF 23- μ A 220-kHz RAIL-TO-RAIL INPUT/OUTPUT
OPERATIONAL AMPLIFIERS WITH SHUTDOWN

SLOS218B – DECEMBER 1998 – REVISED JUNE 1999

TYPICAL CHARACTERISTICS

SHUTDOWN OFF PULSE RESPONSE
VS
TIME

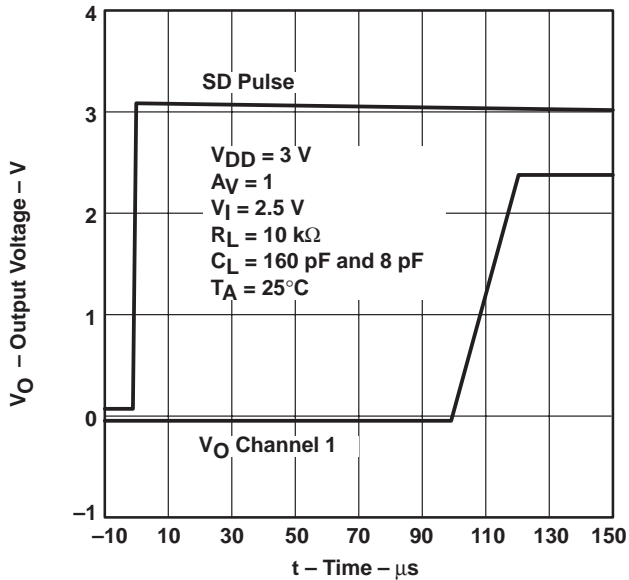

Figure 42

SHUTDOWN OFF PULSE RESPONSE
VS
TIME

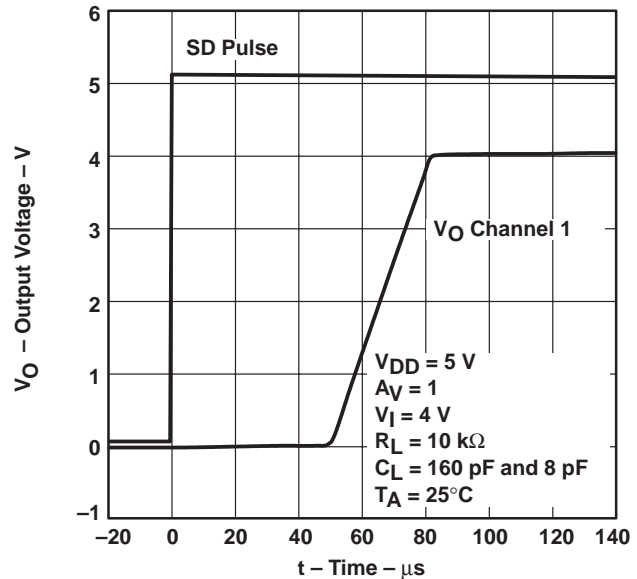

Figure 43

SHUTDOWN ON PULSE RESPONSE
VS
TIME

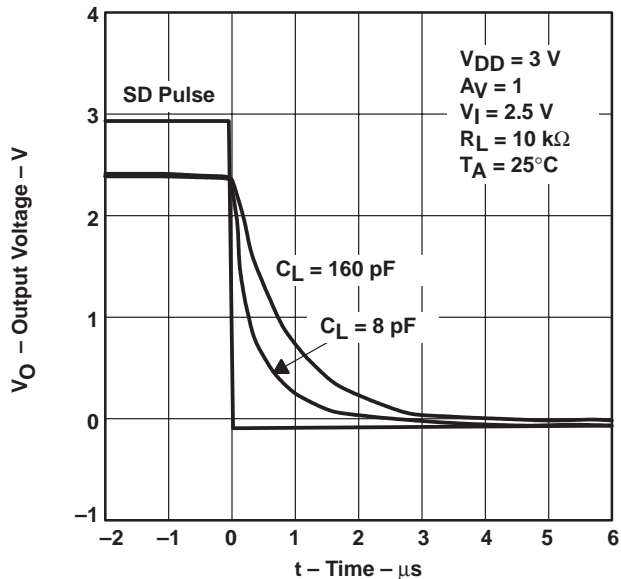

Figure 44

SHUTDOWN ON PULSE RESPONSE
VS
TIME

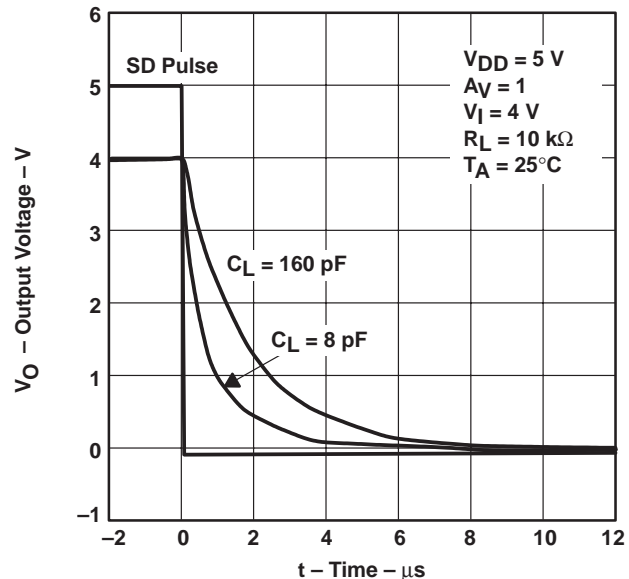

Figure 45



TLV2450, TLV2451, TLV2452, TLV2453, TLV2454, TLV2455, TLV245xA
 FAMILY OF 23- μ A 220-kHz RAIL-TO-RAIL INPUT/OUTPUT
 OPERATIONAL AMPLIFIERS WITH SHUTDOWN

SLOS218B – DECEMBER 1998 – REVISED JUNE 1999

TYPICAL CHARACTERISTICS

SHUTDOWN REVERSE ISOLATION
 VS
 FREQUENCY

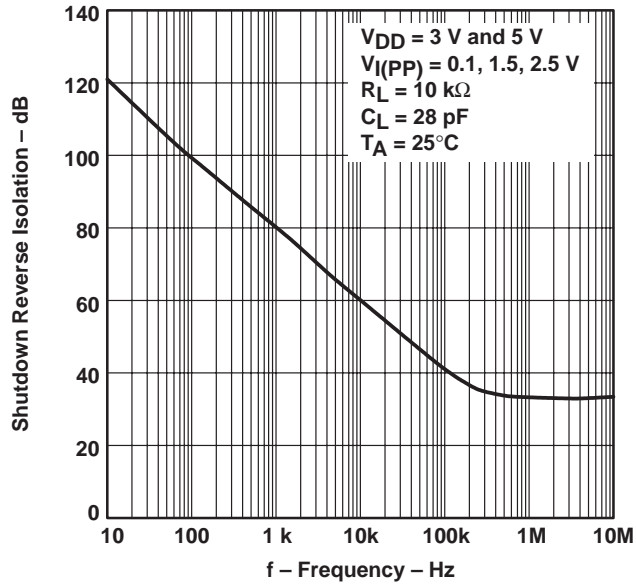

Figure 46

SHUTDOWN FORWARD ISOLATION
 VS
 FREQUENCY

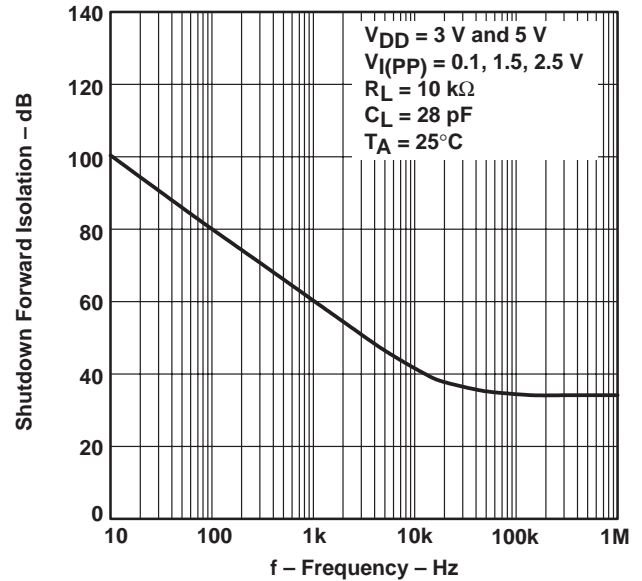

Figure 47

TLV2450, TLV2451, TLV2452, TLV2453, TLV2454, TLV2455, TLV245xA
FAMILY OF 23- μ A 220-kHz RAIL-TO-RAIL INPUT/OUTPUT
OPERATIONAL AMPLIFIERS WITH SHUTDOWN

SLOS218B – DECEMBER 1998 – REVISED JUNE 1999

APPLICATION INFORMATION

general power dissipation considerations

For a given θ_{JA} , the maximum power dissipation is shown in Figure 48 and is calculated by the following formula:

$$P_D = \left(\frac{T_{MAX} - T_A}{\theta_{JA}} \right)$$

Where:

- P_D = Maximum power dissipation of TLV245x IC (watts)
- T_{MAX} = Absolute maximum junction temperature (150°C)
- T_A = Free-ambient air temperature (°C)
- θ_{JA} = $\theta_{JC} + \theta_{CA}$
- θ_{JC} = Thermal coefficient from junction to case
- θ_{CA} = Thermal coefficient from case to ambient air (°C/W)

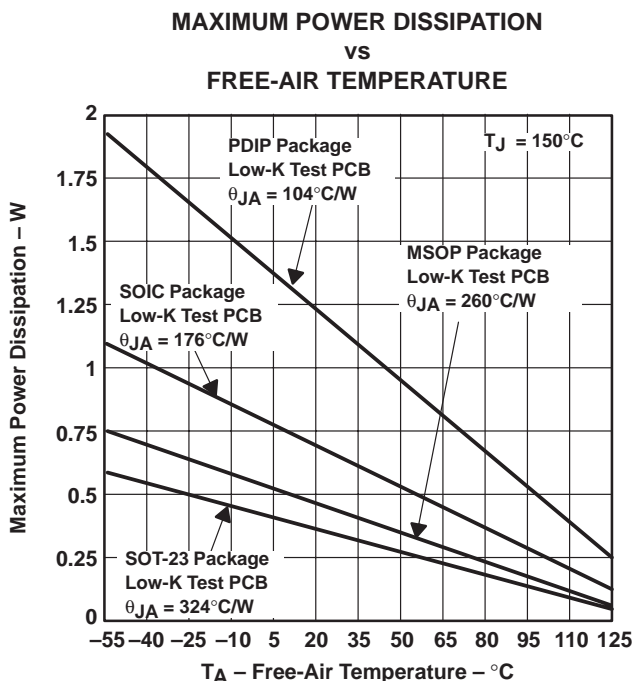

NOTE A: Results are with no air flow and using JEDEC Standard Low-K test PCB.

Figure 48. Maximum Power Dissipation vs Free-Air Temperature



APPLICATION INFORMATION

shutdown function

Three members of the TLV245x family (TLV2450/3/5) have a shutdown terminal for conserving battery life in portable applications. When the shutdown terminal is tied low, the supply current is reduced to 16 nA/channel, the amplifier is disabled, and the outputs are placed in a high impedance mode. To enable the amplifier, the shutdown terminal can either be left floating or pulled high. When the shutdown terminal is left floating, care should be taken to ensure that parasitic leakage current at the shutdown terminal does not inadvertently place the operational amplifier into shutdown. The shutdown terminal threshold is always referenced to $V_{DD}/2$. Therefore, when operating the device with split supply voltages (e.g. ± 2.5 V), the shutdown terminal needs to be pulled to V_{DD-} (not GND) to disable the operational amplifier.

The amplifier's output with a shutdown pulse is shown in Figures 42, 43, 44, and 45. The amplifier is powered with a single 5-V supply and configured as a noninverting configuration with a gain of 5. The amplifier turnon and turnoff times are measured from the 50% point of the shutdown pulse to the 50% point of the output waveform. The times for the single, dual, and quad are listed in the data tables.

Figures 46 and 47 show the amplifier's forward and reverse isolation in shutdown. The operational amplifier is powered by ± 1.35 -V supplies and configured as a voltage follower ($A_V = 1$). The isolation performance is plotted across frequency using 0.1- V_{PP} , 1.5- V_{PP} , and 2.5- V_{PP} input signals. During normal operation, the amplifier would not be able to handle a 2.5- V_{PP} input signal with a supply voltage of ± 1.35 V since it exceeds the common-mode input voltage range (V_{ICR}). However, this curve illustrates that the amplifier remains in shutdown even under a worst case scenario.

macromodel information

Macromodel information provided was derived using Microsim *Parts*[™], the model generation software used with Microsim *PSpice*[™]. The Boyle macromodel (see Note 1) and subcircuit in Figure 49 are generated using the TLV245x typical electrical and operating characteristics at $T_A = 25^\circ\text{C}$. Using this information, output simulations of the following key parameters can be generated to a tolerance of 20% (in most cases):

- Maximum positive output voltage swing
- Maximum negative output voltage swing
- Slew rate
- Quiescent power dissipation
- Input bias current
- Open-loop voltage amplification
- Unity-gain frequency
- Common-mode rejection ratio
- Phase margin
- DC output resistance
- AC output resistance
- Short-circuit output current limit

NOTE 1: G. R. Boyle, B. M. Cohn, D. O. Pederson, and J. E. Solomon, "Macromodeling of Integrated Circuit Operational Amplifiers," *IEEE Journal of Solid-State Circuits*, SC-9, 353 (1974).

PSpice and *Parts* are trademarks of MicroSim Corporation.



TLV2450, TLV2451, TLV2452, TLV2453, TLV2454, TLV2455, TLV245xA FAMILY OF 23- μ A 220-kHz RAIL-TO-RAIL INPUT/OUTPUT OPERATIONAL AMPLIFIERS WITH SHUTDOWN

SLOS218B – DECEMBER 1998 – REVISED JUNE 1999

APPLICATION INFORMATION

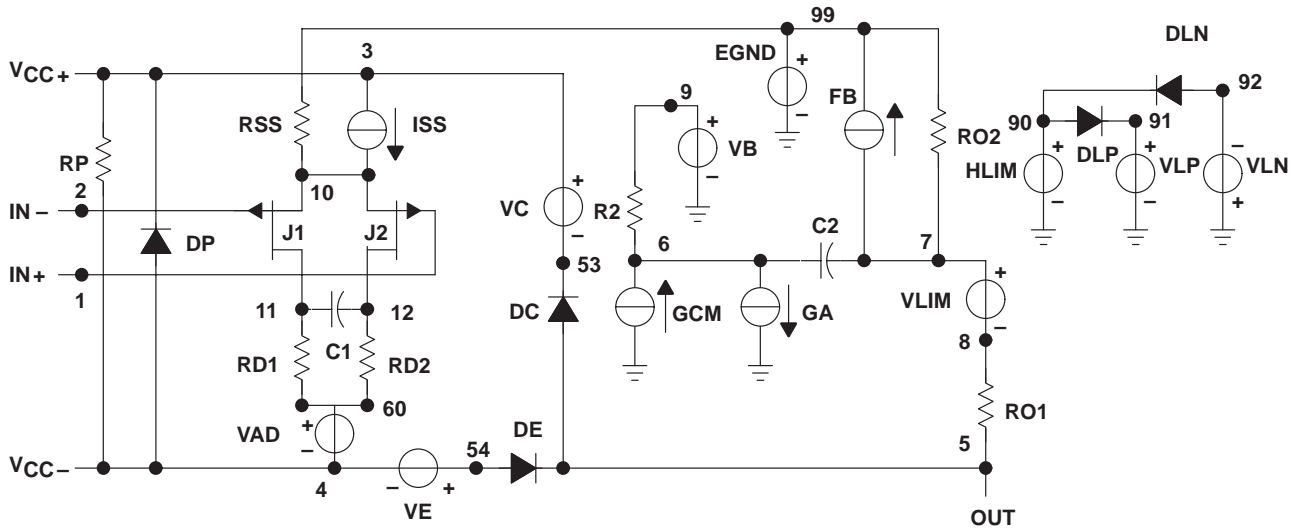

* AMP_TLV2450-X operational amplifier "macromodel" subcircuit
* created using Parts release 8.0 on 10/12/98 at 11:06
* Parts is a MicroSim product.

* connections: non-inverting input
* | inverting input
* | positive power supply
* | negative power supply
* | output
* |
.subckt AMP_TLV2450-X 1 2 3 4 5

c1	11	12	354.48E-15
c2	6	7	7.5000E-12
cee	10	99	42.237E-15
dc	5	53	dy
de	54	5	dy
dlp	90	91	dx
dln	92	90	dx
dp	4	3	dx
egnd	99	0	poly(2) (3,0) (4,0) 0 .5 .5
fb	7	99	poly(5) vb vc ve vlp vln 0
+	207.31E6	-1E3 1E3	210E6 -210E6
ga	6	0	11 12 15.254E-6
gcm	0	6	10 99 48.237E-12

iee	10	4	dc	938.61E-9
hlim	90	0	vlim	1K
q1	11	2	13	qx1
q2	12	1	14	qx2
r2	6	9	100.00E3	
rc1	3	11	65.557E3	
rc2	3	12	65.557E3	
re1	13	10	10.367E3	
re2	14	10	10.367E3	
ree	10	99	213.08E6	
ro1	8	5	10	
ro2	7	99	10	
rp	3	4	147.06	
vb	9	0	dc	0
vc	3	53	dc	.82
ve	54	4	dc	.82
vlim	7	8	dc	0
vlp	91	0	dc	38
vln	0	92	dc	38
.model	dx			D(Is=800.00E-18)
.model	dy			D(Is=800.00E-18 Rs=1m Cjo=10p)
.model	qx1			NPN(Is=800.00E-18 Bf=843.08)
.model	qx2			NPN(Is=800.0000E-18 Bf=843.08)
.ends				

* Schematics Subcircuit *
.subckt TLV2450_ver1 Vout Vdd GND V+ V- SD

```
S_S2 $N_0001 GND SD GND S2
RS_S2 SD GND 1G
.MODEL S2 VSWITCH Roff=1e6 Ron=1.0 Voff=0.0
+ Von=1.0
S_S1 $N_0002 VDD SD GND S1
RS_S1 SD GND 1G
.MODEL S1 VSWITCH Roff=1e6 Ron=1.0 Voff=0.0
+ Von=1.0
S_S3 Vout $N_0003 SD GND S3
RS_S3 SD GND 1G
.MODEL S3 VSWITCH Roff=1e6 Ron=1.0 Voff=0.0
+ Von=1.0
X_SUB_U1 V+ V- $N_0002 $N_003
+ AMP_TLV2450-X
.ENDS tlv2450_ver1
```

* Schematics Subcircuit *
.subckt TLV2451_ver1 V+ V- Vout Vdd GND

```
X_SUB_U1 V+ V- GND Vout AMP_TLV2450-X
.ENDS tlv2451_ver1
```

Figure 49. Boyle Macromodel and Subcircuit



TLV2450, TLV2451, TLV2452, TLV2453, TLV2454, TLV2455, TLV245xA
 FAMILY OF 23- μ A 220-KHz RAIL-TO-RAIL INPUT/OUTPUT
 OPERATIONAL AMPLIFIERS WITH SHUTDOWN

SLOS218B – DECEMBER 1998 – REVISED JUNE 1999

MECHANICAL DATA

D (R-PDSO-G**)

PLASTIC SMALL-OUTLINE PACKAGE

14 PIN SHOWN

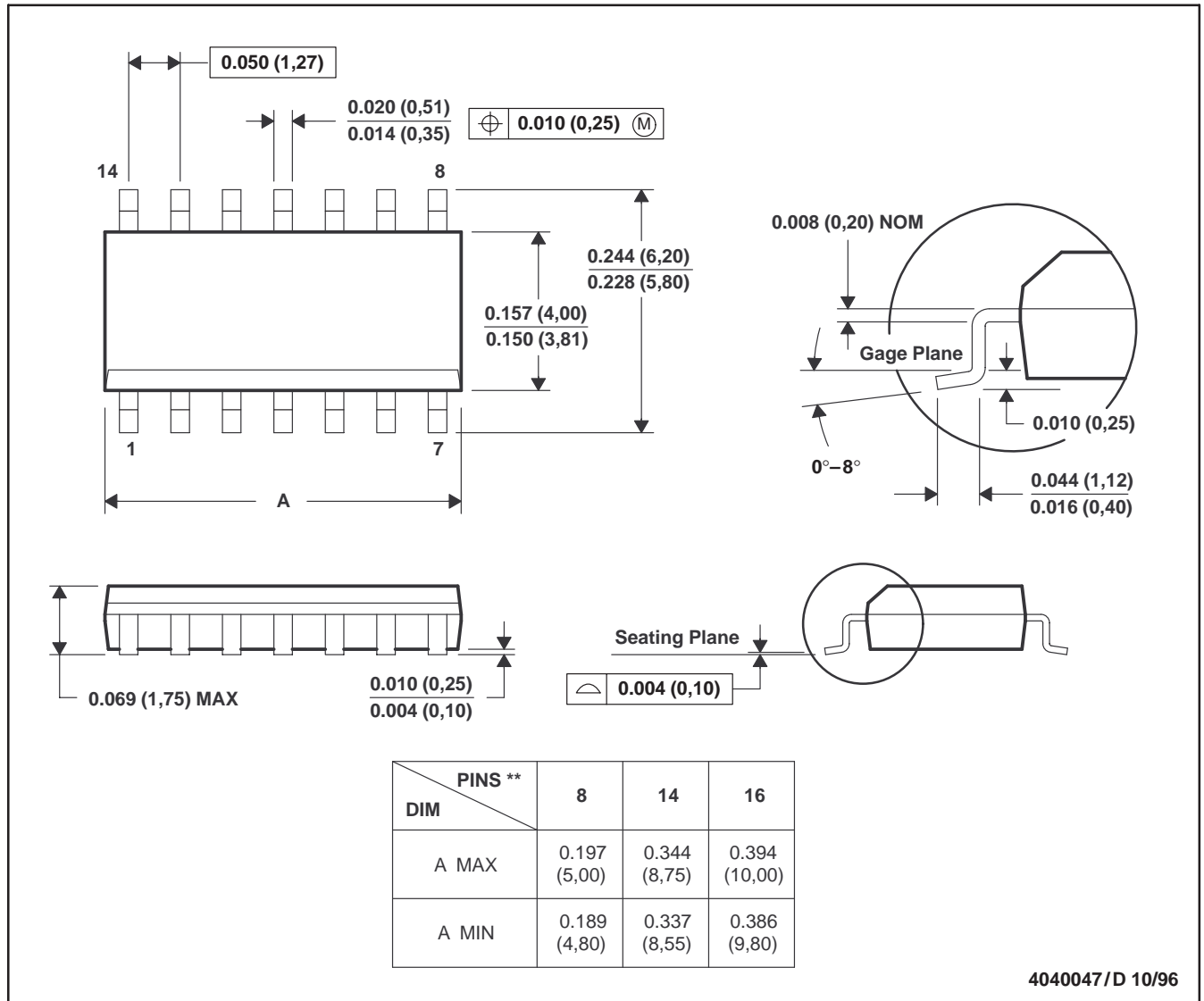

- NOTES: B. All linear dimensions are in inches (millimeters).
 C. This drawing is subject to change without notice.
 D. Body dimensions do not include mold flash or protrusion, not to exceed 0.006 (0,15).
 E. Falls within JEDEC MS-012

TLV2450, TLV2451, TLV2452, TLV2453, TLV2454, TLV2455, TLV245xA
FAMILY OF 23- μ A 220-kHz RAIL-TO-RAIL INPUT/OUTPUT
OPERATIONAL AMPLIFIERS WITH SHUTDOWN

SLOS218B – DECEMBER 1998 – REVISED JUNE 1999

MECHANICAL INFORMATION

DBV (R-PDSO-G5)

PLASTIC SMALL-OUTLINE PACKAGE

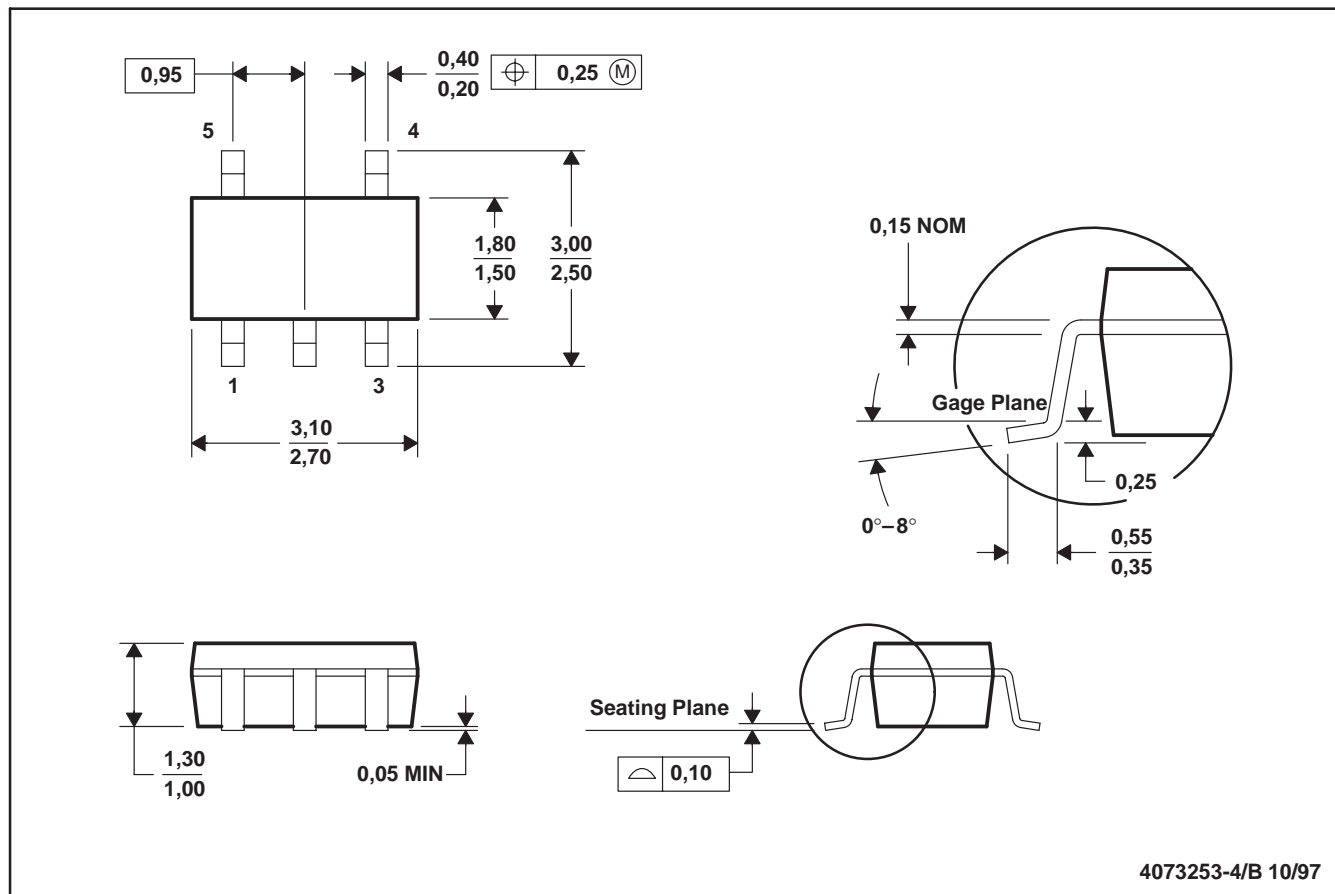

4073253-4/B 10/97

- NOTES: A. All linear dimensions are in millimeters.
 B. This drawing is subject to change without notice.
 C. Body dimensions include mold flash or protrusion.

TLV2450, TLV2451, TLV2452, TLV2453, TLV2454, TLV2455, TLV245xA
 FAMILY OF 23- μ A 220-KHz RAIL-TO-RAIL INPUT/OUTPUT
 OPERATIONAL AMPLIFIERS WITH SHUTDOWN

SLOS218B – DECEMBER 1998 – REVISED JUNE 1999

MECHANICAL INFORMATION

DBV (R-PDSO-G6)

PLASTIC SMALL-OUTLINE PACKAGE

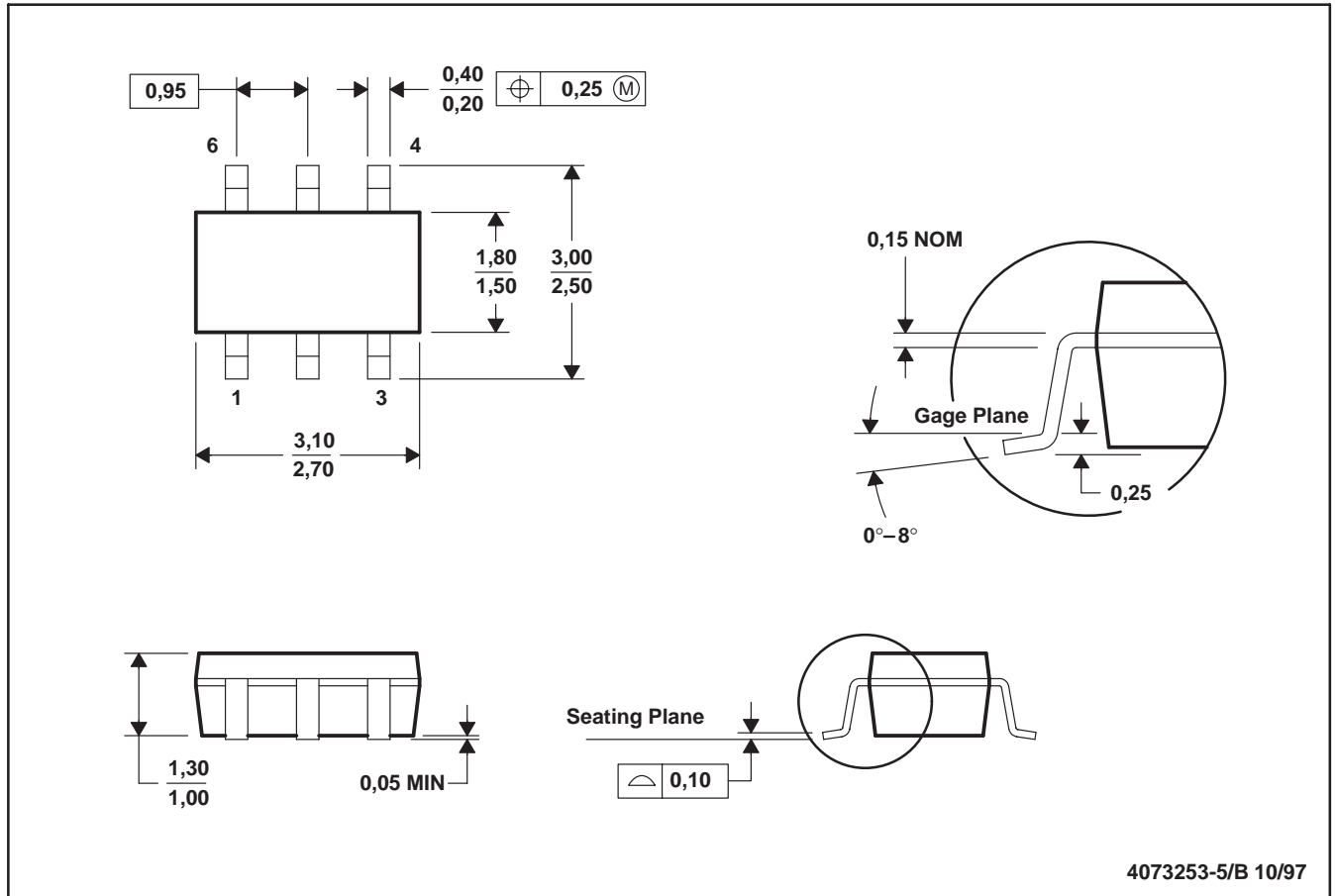

4073253-5/B 10/97

- NOTES: A. All linear dimensions are in millimeters.
 B. This drawing is subject to change without notice.
 C. Body dimensions include mold flash or protrusion.

TLV2450, TLV2451, TLV2452, TLV2453, TLV2454, TLV2455, TLV245xA
FAMILY OF 23- μ A 220-kHz RAIL-TO-RAIL INPUT/OUTPUT
OPERATIONAL AMPLIFIERS WITH SHUTDOWN

SLOS218B – DECEMBER 1998 – REVISED JUNE 1999

MECHANICAL INFORMATION

DGK (R-PDSO-G8)

PLASTIC SMALL-OUTLINE PACKAGE

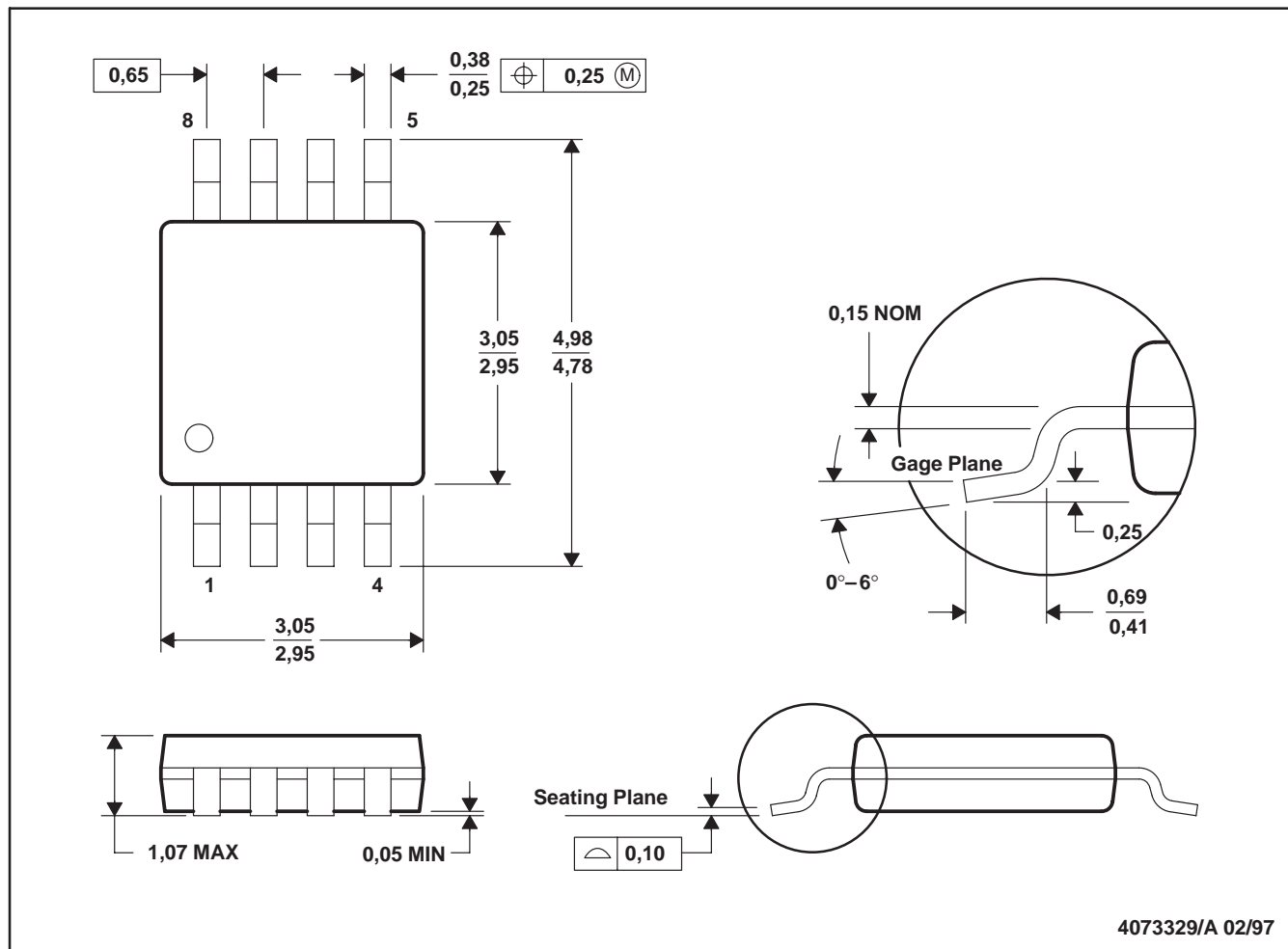

4073329/A 02/97

- NOTES: A. All linear dimensions are in millimeters.
 B. This drawing is subject to change without notice.
 C. Body dimensions do not include mold flash or protrusion.

TLV2450, TLV2451, TLV2452, TLV2453, TLV2454, TLV2455, TLV245xA
 FAMILY OF 23- μ A 220-KHz RAIL-TO-RAIL INPUT/OUTPUT
 OPERATIONAL AMPLIFIERS WITH SHUTDOWN

SLOS218B – DECEMBER 1998 – REVISED JUNE 1999

MECHANICAL INFORMATION

DGS (S-PDSO-G10)

PLASTIC SMALL-OUTLINE PACKAGE

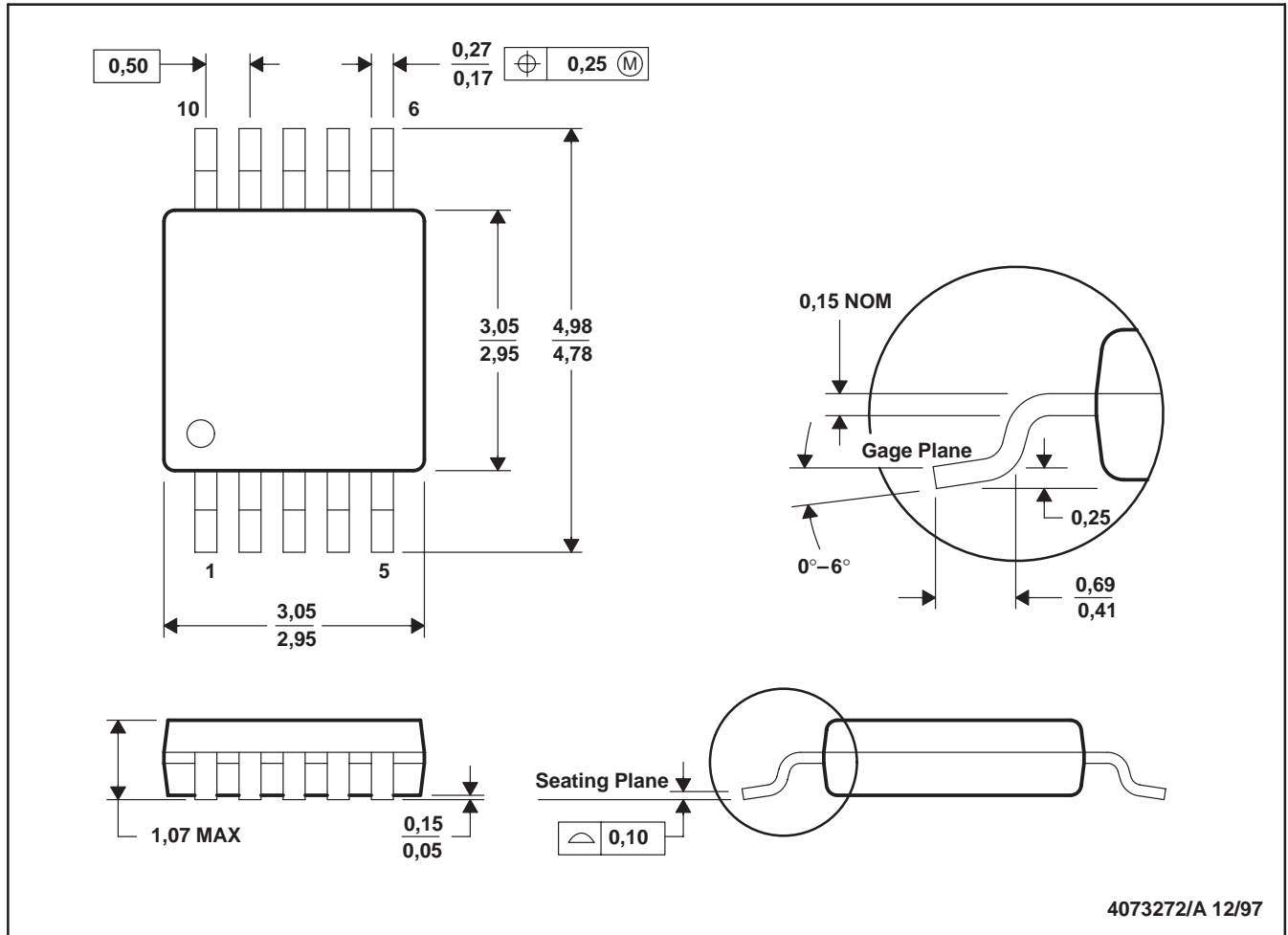

- NOTES: A. All linear dimensions are in millimeters.
 B. This drawing is subject to change without notice.
 C. Body dimensions do not include mold flash or protrusion.

TLV2450, TLV2451, TLV2452, TLV2453, TLV2454, TLV2455, TLV245xA
FAMILY OF 23- μ A 220-kHz RAIL-TO-RAIL INPUT/OUTPUT
OPERATIONAL AMPLIFIERS WITH SHUTDOWN

SLOS218B – DECEMBER 1998 – REVISED JUNE 1999

MECHANICAL INFORMATION

N (R-PDIP-T)**

PLASTIC DUAL-IN-LINE PACKAGE

16 PIN SHOWN

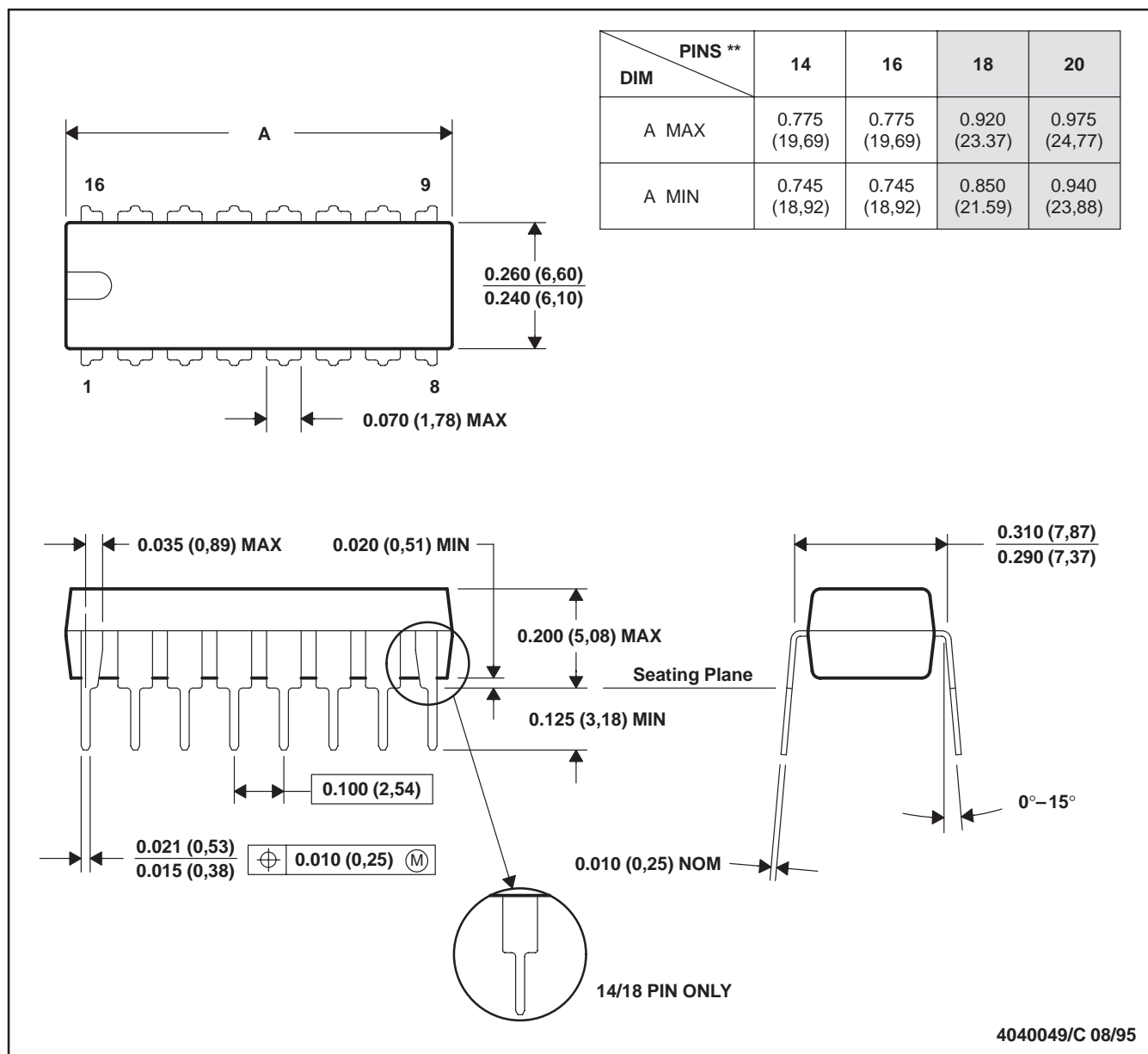

- NOTES: A. All linear dimensions are in inches (millimeters).
 B. This drawing is subject to change without notice.
 C. Falls within JEDEC MS-001 (20 pin package is shorter than MS-001.)



POST OFFICE BOX 655303 • DALLAS, TEXAS 75265

TLV2450, TLV2451, TLV2452, TLV2453, TLV2454, TLV2455, TLV245xA
 FAMILY OF 23- μ A 220-KHz RAIL-TO-RAIL INPUT/OUTPUT
 OPERATIONAL AMPLIFIERS WITH SHUTDOWN

SLOS218B – DECEMBER 1998 – REVISED JUNE 1999

MECHANICAL INFORMATION

P (R-PDIP-T8)

PLASTIC DUAL-IN-LINE PACKAGE

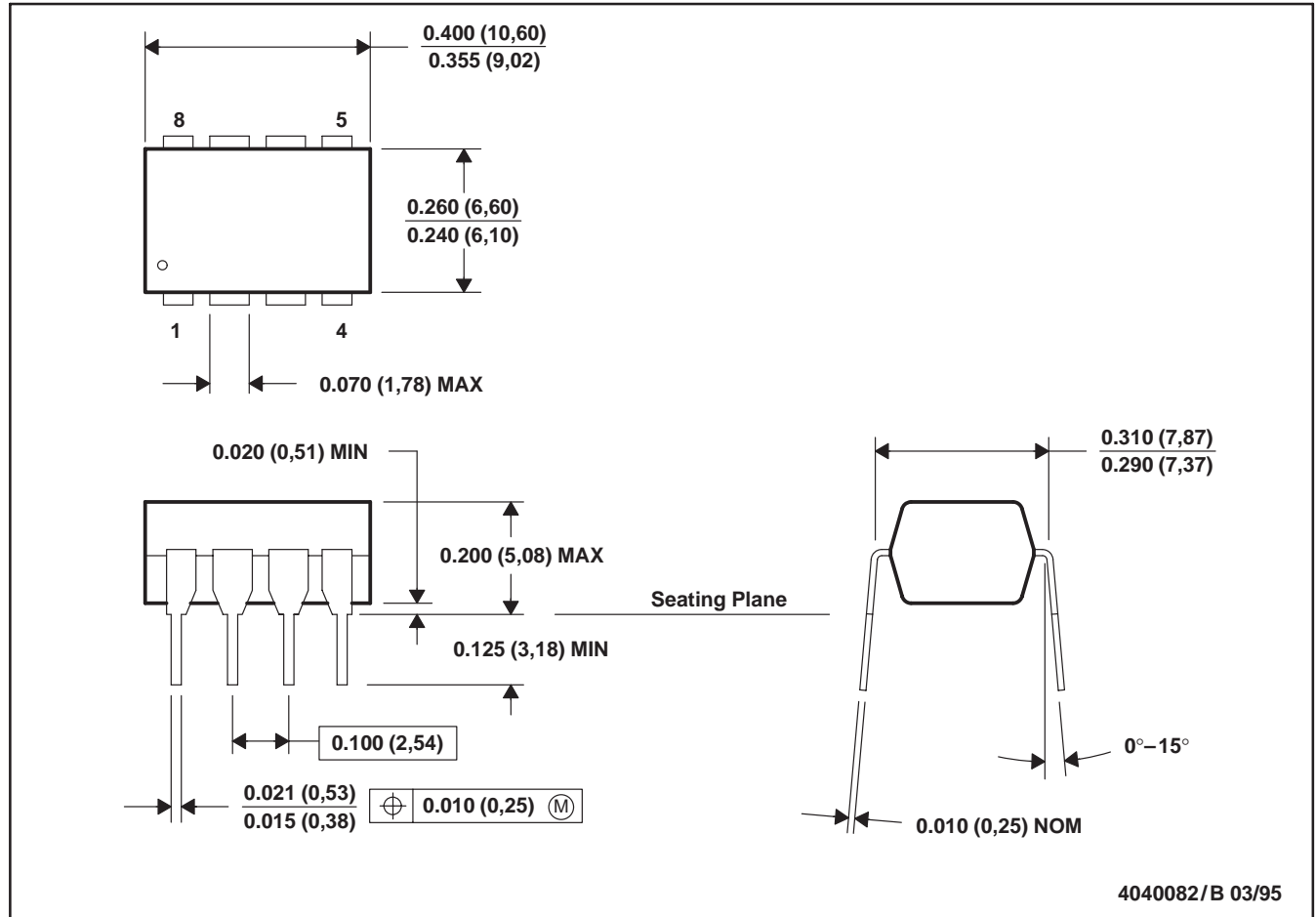

- NOTES: A. All linear dimensions are in inches (millimeters).
 B. This drawing is subject to change without notice.
 C. Falls within JEDEC MS-001

TLV2450, TLV2451, TLV2452, TLV2453, TLV2454, TLV2455, TLV245xA
FAMILY OF 23- μ A 220-kHz RAIL-TO-RAIL INPUT/OUTPUT
OPERATIONAL AMPLIFIERS WITH SHUTDOWN

SLOS218B – DECEMBER 1998 – REVISED JUNE 1999

MECHANICAL INFORMATION

PW (R-PDSO-G)**

PLASTIC SMALL-OUTLINE PACKAGE

14 PIN SHOWN

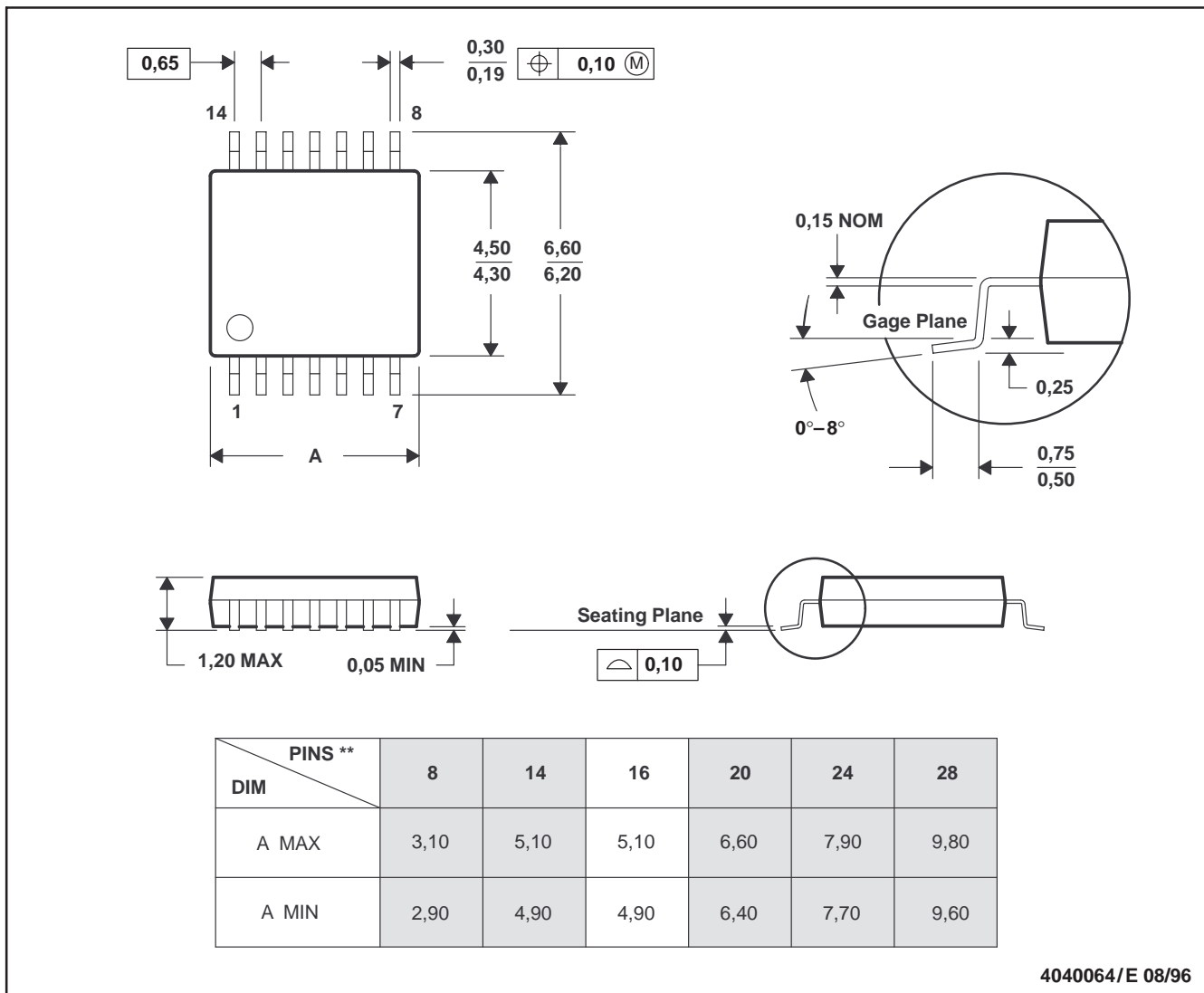

4040064/E 08/96

- NOTES: A. All linear dimensions are in millimeters.
 B. This drawing is subject to change without notice.
 C. Body dimensions do not include mold flash or protrusion not to exceed 0,15.
 D. Falls within JEDEC MO-153

IMPORTANT NOTICE

Texas Instruments and its subsidiaries (TI) reserve the right to make changes to their products or to discontinue any product or service without notice, and advise customers to obtain the latest version of relevant information to verify, before placing orders, that information being relied on is current and complete. All products are sold subject to the terms and conditions of sale supplied at the time of order acknowledgement, including those pertaining to warranty, patent infringement, and limitation of liability.

TI warrants performance of its semiconductor products to the specifications applicable at the time of sale in accordance with TI's standard warranty. Testing and other quality control techniques are utilized to the extent TI deems necessary to support this warranty. Specific testing of all parameters of each device is not necessarily performed, except those mandated by government requirements.

CERTAIN APPLICATIONS USING SEMICONDUCTOR PRODUCTS MAY INVOLVE POTENTIAL RISKS OF DEATH, PERSONAL INJURY, OR SEVERE PROPERTY OR ENVIRONMENTAL DAMAGE ("CRITICAL APPLICATIONS"). TI SEMICONDUCTOR PRODUCTS ARE NOT DESIGNED, AUTHORIZED, OR WARRANTED TO BE SUITABLE FOR USE IN LIFE-SUPPORT DEVICES OR SYSTEMS OR OTHER CRITICAL APPLICATIONS. INCLUSION OF TI PRODUCTS IN SUCH APPLICATIONS IS UNDERSTOOD TO BE FULLY AT THE CUSTOMER'S RISK.

In order to minimize risks associated with the customer's applications, adequate design and operating safeguards must be provided by the customer to minimize inherent or procedural hazards.

TI assumes no liability for applications assistance or customer product design. TI does not warrant or represent that any license, either express or implied, is granted under any patent right, copyright, mask work right, or other intellectual property right of TI covering or relating to any combination, machine, or process in which such semiconductor products or services might be or are used. TI's publication of information regarding any third party's products or services does not constitute TI's approval, warranty or endorsement thereof.