

TLV271-Q1, TLV272-Q1, TLV274-Q1 FAMILY OF 550- μ A/Ch 3-MHz RAIL-TO-RAIL OUTPUT OPERATIONAL AMPLIFIERS

SGLS275A – OCTOBER 2004 – REVISED JUNE 2008

- Qualified for Automotive Applications
- Rail-To-Rail Output
- Wide Bandwidth . . . 3 MHz
- High Slew Rate . . . 2.4 V/ μ s
- Supply Voltage Range . . . 2.7 V to 16 V
- Supply Current . . . 550 μ A/Channel
- Input Noise Voltage . . . 39 nV/ $\sqrt{\text{Hz}}$
- Input Bias Current . . . 1 pA
- Specified Temperature Range
–40°C to 125°C . . . Automotive Grade
- Ultrasmall Packaging
– 5-Pin SOT-23 (TLV271)
- Ideal Upgrade for TLC27x Family

Operational Amplifier

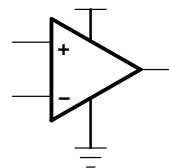

description

The TLV27x takes the minimum operating supply voltage down to 2.7 V over the extended automotive temperature range while adding the rail-to-rail output swing feature. This makes it an ideal alternative to the TLC27x family for applications where rail-to-rail output swings are essential. The TLV27x also provides 3-MHz bandwidth from only 550 μ A.

Like the TLC27x, the TLV27x is fully specified for 5-V and \pm 5-V supplies. The maximum recommended supply voltage is 16 V, which allows the devices to be operated from a variety of rechargeable cells (\pm 8 V supplies down to \pm 1.35 V).

The CMOS inputs enable use in high-impedance sensor interfaces, with the lower voltage operation making an attractive alternative for the TLC27x in battery-powered applications.

The 2.7-V operation makes it compatible with Li-Ion powered systems and the operating supply voltage range of many micropower microcontrollers available today including Texas Instruments MSP430.

SELECTION OF SIGNAL AMPLIFIER PRODUCTS†

| DEVICE | V _{DD} (V) | V _{IO} (μ V) | I _q /Ch (μ A) | I _{IB} (pA) | GBW (MHz) | SR (V/ μ s) | SHUTDOWN | RAIL-TO-RAIL | SINGLES/DUALS/QUADS |
|---------|---------------------|----------------------------|-------------------------------|----------------------|-----------|-----------------|----------|--------------|---------------------|
| TLV27x | 2.7–16 | 500 | 550 | 1 | 3 | 2.4 | — | O | S/D/Q |
| TLC27x | 3–16 | 1100 | 675 | 1 | 1.7 | 3.6 | — | — | S/D/Q |
| TLV237x | 2.7–16 | 500 | 550 | 1 | 3 | 2.4 | Yes | I/O | S/D/Q |
| TLC227x | 4–16 | 300 | 1100 | 1 | 2.2 | 3.6 | — | O | D/Q |
| TLV246x | 2.7–6 | 150 | 550 | 1300 | 6.4 | 1.6 | Yes | I/O | S/D/Q |
| TLV247x | 2.7–6 | 250 | 600 | 2 | 2.8 | 1.5 | Yes | I/O | S/D/Q |
| TLV244x | 2.7–10 | 300 | 725 | 1 | 1.8 | 1.4 | — | O | D/Q |

† Typical values measured at 5 V, 25°C



Please be aware that an important notice concerning availability, standard warranty, and use in critical applications of Texas Instruments semiconductor products and disclaimers thereto appears at the end of this data sheet.

PRODUCTION DATA information is current as of publication date. Products conform to specifications per the terms of Texas Instruments standard warranty. Production processing does not necessarily include testing of all parameters.

**TEXAS
INSTRUMENTS**

POST OFFICE BOX 655303 • DALLAS, TEXAS 75265

Copyright © 2008 Texas Instruments Incorporated

TLV271-Q1, TLV272-Q1, TLV274-Q1 FAMILY OF 550- μ A/Ch 3-MHz RAIL-TO-RAIL OUTPUT OPERATIONAL AMPLIFIERS

SGLS275A – OCTOBER 2004 – REVISED JUNE 2008

FAMILY PACKAGE TABLE[†]

| DEVICE | NUMBER OF CHANNELS | PACKAGE TYPES [‡] | | | | UNIVERSAL EVM BOARD |
|--------|--------------------|----------------------------|--------|-------|-------------------|---------------------------------------|
| | | SOIC | SOT-23 | TSSOP | MSOP [§] | |
| TLV271 | 1 | 8 | 5 | — | — | See the EVM Selection Guide (SLOU060) |
| TLV272 | 2 | 8 | — | — | 8 | |
| TLV274 | 4 | 14 | — | 14 | — | |

[†] For the most current package and ordering information, see the Package Option Addendum at the end of this document, or see the TI web site at <http://www.ti.com>.

[‡] Package drawings, thermal data, and symbolization are available at <http://www.ti.com/packaging>.

[§] Product Preview

TLV271 AVAILABLE OPTIONS

| T _A | V _{IO} MAX AT 25°C | PACKAGED DEVICES | | |
|----------------|-----------------------------|-------------------|---------------|--------|
| | | SMALL OUTLINE (D) | SOT-23 | |
| | | | (DBV) | SYMBOL |
| -40°C to 125°C | 5 mV | TLV271QDRQ1 | TLV271QDBVRQ1 | 271Q |

TLV272 AVAILABLE OPTIONS

| T _A | V _{IO} MAX AT 25°C | PACKAGED DEVICES | | |
|----------------|-----------------------------|-------------------|----------------------------|--------|
| | | SMALL OUTLINE (D) | MSOP | |
| | | | (DGK) | SYMBOL |
| -40°C to 125°C | 5 mV | TLV272QDRQ1 | TLV272QDGKRQ1 [†] | |

[†] Product Preview

TLV274 AVAILABLE OPTIONS

| T _A | V _{IO} MAX AT 25°C | PACKAGED DEVICES | |
|----------------|-----------------------------|-------------------|--------------|
| | | SMALL OUTLINE (D) | TSSOP (PW) |
| -40°C to 125°C | 5 mV | TLV274QDRQ1 | TLV274QPWRQ1 |



TLV271-Q1, TLV272-Q1, TLV274-Q1 FAMILY OF 550- μ A/Ch 3-MHz RAIL-TO-RAIL OUTPUT OPERATIONAL AMPLIFIERS

SGLS275A – OCTOBER 2004 – REVISED JUNE 2008

TLV27x PACKAGE PINOUTS(1)

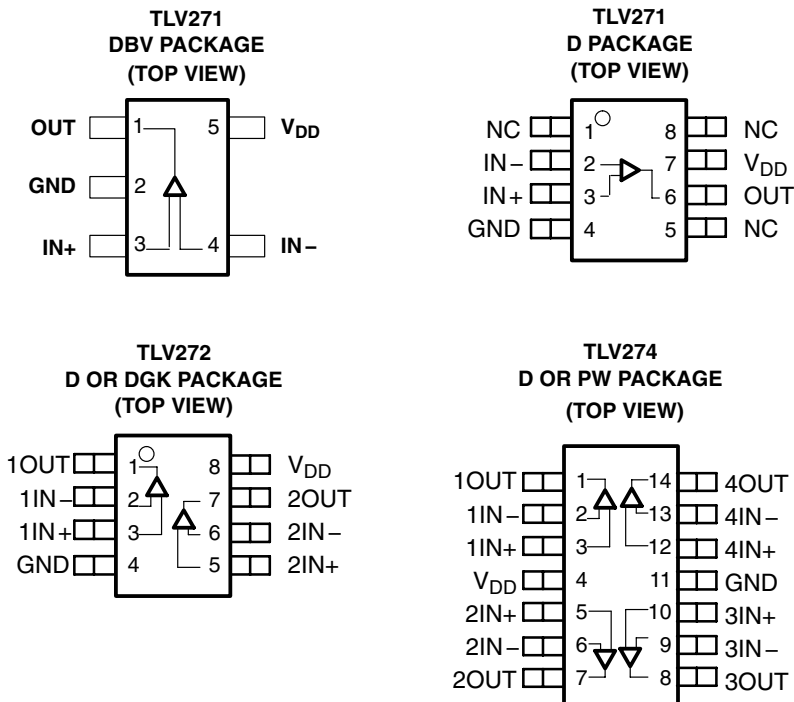

NC – No internal connection
(1) SOT-23 may or may not be indicated

TYPICAL PIN 1 INDICATORS

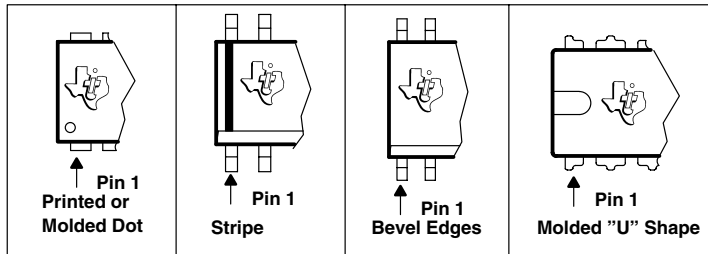

TLV271-Q1, TLV272-Q1, TLV274-Q1

FAMILY OF 550- μ A/Ch 3-MHz RAIL-TO-RAIL OUTPUT OPERATIONAL AMPLIFIERS

SGLS275A – OCTOBER 2004 – REVISED JUNE 2008

absolute maximum ratings over operating free-air temperature range (unless otherwise noted)[†]

| | |
|--|------------------------------|
| Supply voltage, V_{DD} (see Note 1) | 16.5 V |
| Differential input voltage, V_{ID} | $\pm V_{DD}$ |
| Input voltage range, V_I (see Note 1) | -0.2 V to $V_{DD} + 0.2$ V |
| Input current range, I_I | ± 10 mA |
| Output current range, I_O | ± 100 mA |
| Continuous total power dissipation | See Dissipation Rating Table |
| Operating free-air temperature range, T_A | -40°C to 125°C |
| Maximum junction temperature, T_J | 150°C |
| Storage temperature range, T_{stg} | -65°C to 150°C |
| Lead temperature 1,6 mm (1/16 inch) from case for 10 seconds | 260°C |

[†] Stresses beyond those listed under “absolute maximum ratings” may cause permanent damage to the device. These are stress ratings only, and functional operation of the device at these or any other conditions beyond those indicated under “recommended operating conditions” is not implied. Exposure to absolute-maximum-rated conditions for extended periods may affect device reliability.

NOTE 1: All voltage values, except differential voltages, are with respect to GND.

DISSIPATION RATING TABLE

| PACKAGE | θ_{JC} (°C/W) | θ_{JA} (°C/W) | $T_A \leq 25^\circ\text{C}$ POWER RATING | $T_A = 25^\circ\text{C}$ POWER RATING |
|---------|-------------------------|-------------------------|---|--|
| D (8) | 38.3 | 176 | 710 mW | 396 mW |
| D (14) | 26.9 | 122.3 | 1022 mW | 531 mW |
| DBV (5) | 55 | 324.1 | 385 mW | 201 mW |
| DGK (8) | 54.23 | 259.96 | 481 mW | 250 mW |
| PW (14) | 29.3 | 173.6 | 720 mW | 374 mW |

recommended operating conditions

| | | MIN | MAX | UNIT |
|--|---------------|------------|-----------------|------|
| Supply voltage, V_{DD} | Single supply | 2.7 | 16 | V |
| | Split supply | ± 1.35 | ± 8 | |
| Common-mode input voltage range, V_{ICR} | | 0 | $V_{DD} - 1.35$ | V |
| Operating free-air temperature, T_A | | -40 | 125 | °C |



TLV271-Q1, TLV272-Q1, TLV274-Q1
FAMILY OF 550- μ A/Ch 3-MHz RAIL-TO-RAIL OUTPUT
OPERATIONAL AMPLIFIERS

SGLS275A – OCTOBER 2004 – REVISED JUNE 2008

electrical characteristics at specified free-air temperature, $V_{DD} = 2.7$ V, 5 V, and 15 V (unless otherwise noted)

dc performance

| PARAMETER | | TEST CONDITIONS | | T_A † | MIN | TYP | MAX | UNIT |
|----------------|---|---|--|------------|-----|-----|-----|------------|
| V_{IO} | Input offset voltage | $V_{IC} = V_{DD}/2,$ $R_L = 10$ k $\Omega,$ | $V_O = V_{DD}/2,$ $R_S = 50$ Ω | 25°C | 0.5 | | 5 | mV |
| | | | | Full range | | | 7 | |
| α_{VIO} | Offset voltage drift | | | 25°C | | 2 | | μ V/°C |
| $CMRR$ | Common-mode rejection ratio | $V_{IC} = 0$ to $V_{DD}-1.35$ V, $R_S = 50$ Ω | $V_{DD} = 2.7$ V | 25°C | 53 | | 70 | dB |
| | | | | Full range | 54 | | | |
| | | $V_{IC} = 0$ to $V_{DD}-1.35$ V, $R_S = 50$ Ω | $V_{DD} = 5$ V | 25°C | 58 | | 80 | |
| | | | | Full range | 57 | | | |
| | | $V_{IC} = 0$ to $V_{DD}-1.35$ V, $R_S = 50$ Ω | $V_{DD} = 15$ V | 25°C | 67 | | 85 | |
| | | | | Full range | 66 | | | |
| A_{VD} | Large-signal differential voltage amplification | $V_{O(PP)} = V_{DD}/2,$ $R_L = 10$ k Ω | $V_{DD} = 2.7$ V | 25°C | 95 | | 106 | dB |
| | | | | Full range | 76 | | | |
| | | | $V_{DD} = 5$ V | 25°C | 80 | | 110 | |
| | | | | Full range | 82 | | | |
| | | | $V_{DD} = 15$ V | 25°C | 77 | | 115 | |
| | | | | Full range | 79 | | | |

† Full range is –40°C to 125°C. If not specified, full range is –40°C to 125°C.

input characteristics

| PARAMETER | | TEST CONDITIONS | | T_A | MIN | TYP | MAX | UNIT |
|------------|-------------------------------|---------------------------------------|-------------------------------------|-------|-----|------|------|------------|
| I_{IO} | Input offset current | $V_{DD} = 15$ V, $V_{IC} = V_{DD}/2,$ | $V_O = V_{DD}/2, R_S = 50$ Ω | 25°C | | 1 | 60 | pA |
| | | | | 125°C | | | 1000 | |
| I_{IB} | Input bias current | $V_{DD} = 15$ V, $V_{IC} = V_{DD}/2,$ | $V_O = V_{DD}/2, R_S = 50$ Ω | 25°C | | 1 | 60 | pA |
| | | | | 125°C | | | 1000 | |
| $r_{i(d)}$ | Differential input resistance | | | 25°C | | 1000 | | G Ω |
| C_{IC} | Common-mode input capacitance | | $f = 21$ kHz | 25°C | | 8 | | pF |



TLV271-Q1, TLV272-Q1, TLV274-Q1
FAMILY OF 550- μ A/Ch 3-MHz RAIL-TO-RAIL OUTPUT
OPERATIONAL AMPLIFIERS

SGLS275A – OCTOBER 2004 – REVISED JUNE 2008

electrical characteristics at specified free-air temperature, $V_{DD} = 2.7\text{ V}$, 5 V , and 15 V (unless otherwise noted)

output characteristics

| PARAMETER | TEST CONDITIONS | T_A † | MIN | TYP | MAX | UNIT |
|------------------------------------|---|-------------------------|------------|-------|-------|------|
| V_{OH} High-level output voltage | $V_{IC} = V_{DD}/2, I_{OH} = -1\text{ mA}$ | $V_{DD} = 2.7\text{ V}$ | 25°C | 2.55 | 2.58 | V |
| | | | Full range | 2.48 | | |
| | | $V_{DD} = 5\text{ V}$ | 25°C | 4.9 | 4.93 | |
| | | | Full range | 4.85 | | |
| | | $V_{DD} = 15\text{ V}$ | 25°C | 14.92 | 14.96 | |
| | | | Full range | 14.9 | | |
| | $V_{IC} = V_{DD}/2, I_{OH} = -5\text{ mA}$ | $V_{DD} = 2.7\text{ V}$ | 25°C | 1.88 | 2.1 | |
| | | | Full range | 1.42 | | |
| | | $V_{DD} = 5\text{ V}$ | 25°C | 4.58 | 4.68 | |
| | | | Full range | 4.44 | | |
| | | $V_{DD} = 15\text{ V}$ | 25°C | 14.7 | 14.8 | |
| | | | Full range | 14.6 | | |
| V_{OL} Low-level output voltage | $V_{IC} = V_{DD}/2, I_{OL} = 1\text{ mA}$ | $V_{DD} = 2.7\text{ V}$ | 25°C | 0.1 | 0.15 | V |
| | | | Full range | | 0.22 | |
| | | $V_{DD} = 5\text{ V}$ | 25°C | 0.05 | 0.1 | |
| | | | Full range | | 0.15 | |
| | | $V_{DD} = 15\text{ V}$ | 25°C | 0.05 | 0.08 | |
| | | | Full range | | 0.1 | |
| | $V_{IC} = V_{DD}/2, I_{OL} = 5\text{ mA}$ | $V_{DD} = 2.7\text{ V}$ | 25°C | 0.5 | 0.7 | |
| | | | Full range | | 1.15 | |
| | | $V_{DD} = 5\text{ V}$ | 25°C | 0.28 | 0.4 | |
| | | | Full range | | 0.54 | |
| | | $V_{DD} = 15\text{ V}$ | 25°C | 0.19 | 0.3 | |
| | | | Full range | | 0.35 | |
| I_O Output current | $V_O = 0.5\text{ V from rail}, V_{DD} = 2.7\text{ V}$ | Positive rail | 25°C | 4 | mA | |
| | | Negative rail | 25°C | 5 | | |
| | $V_O = 0.5\text{ V from rail}, V_{DD} = 5\text{ V}$ | Positive rail | 25°C | 7 | | |
| | | Negative rail | 25°C | 8 | | |
| | $V_O = 0.5\text{ V from rail}, V_{DD} = 15\text{ V}$ | Positive rail | 25°C | 13 | | |
| | | Negative rail | 25°C | 12 | | |

† Full range is -40°C to 125°C . If not specified, full range is -40°C to 125°C .

‡ Depending on package dissipation rating



TLV271-Q1, TLV272-Q1, TLV274-Q1
FAMILY OF 550- μ A/Ch 3-MHz RAIL-TO-RAIL OUTPUT
OPERATIONAL AMPLIFIERS

SGLS275A – OCTOBER 2004 – REVISED JUNE 2008

electrical characteristics at specified free-air temperature, $V_{DD} = 2.7\text{ V}$, 5 V , and 15 V (unless otherwise noted) (continued)

power supply

| PARAMETER | | TEST CONDITIONS | T_A † | MIN | TYP | MAX | UNIT |
|-----------|--|---|-------------------------|------------|------|-----|---------------|
| I_{DD} | Supply current (per channel) | $V_O = V_{DD}/2$ | $V_{DD} = 2.7\text{ V}$ | 25°C | 470 | 560 | μA |
| | | | $V_{DD} = 5\text{ V}$ | | 550 | 660 | |
| | | | $V_{DD} = 15\text{ V}$ | 25°C | 750 | 900 | |
| | | | | Full range | 1200 | | |
| PSRR | Supply voltage rejection ratio ($\Delta V_{DD}/\Delta V_{IO}$) | $V_{DD} = 2.7\text{ V to }15\text{ V}$, No load | $V_{IC} = V_{DD}/2$ | 25°C | 70 | 80 | dB |
| | | | | Full range | 65 | | |

† Full range is -40°C to 125°C . If not specified, full range is -40°C to 125°C .

dynamic performance

| PARAMETER | | TEST CONDITIONS | T_A † | MIN | TYP | MAX | UNIT |
|-----------|-------------------------|---|--------------------------------------|------------|-----|-----|------------------------|
| UGBW | Unity gain bandwidth | $R_L = 2\text{ k}\Omega$, $C_L = 10\text{ pF}$ | $V_{DD} = 2.7\text{ V}$ | 25°C | 2.4 | | MHz |
| | | | $V_{DD} = 5\text{ V to }15\text{ V}$ | | 3 | | |
| SR | Slew rate at unity gain | $V_{O(PP)} = V_{DD}/2$, $C_L = 50\text{ pF}$, $R_L = 10\text{ k}\Omega$, | $V_{DD} = 2.7\text{ V}$ | 25°C | 1.4 | 2.1 | $\text{V}/\mu\text{s}$ |
| | | | | Full range | 1 | | |
| | | | $V_{DD} = 5\text{ V}$ | 25°C | 1.4 | 2.4 | $\text{V}/\mu\text{s}$ |
| | | | | Full range | 1.2 | | |
| | | | $V_{DD} = 15\text{ V}$ | 25°C | 1.9 | 2.1 | $\text{V}/\mu\text{s}$ |
| | | | | Full range | 1.4 | | |
| ϕ_m | Phase margin | $R_L = 2\text{ k}\Omega$ | $C_L = 10\text{ pF}$ | 25°C | 65 | | $^\circ$ |
| | Gain margin | $R_L = 2\text{ k}\Omega$ | $C_L = 10\text{ pF}$ | 25°C | 18 | | dB |
| t_s | Settling time | $V_{DD} = 2.7\text{ V}$, $V_{(STEP)PP} = 1\text{ V}$, $A_V = -1$, $C_L = 10\text{ pF}$, $R_L = 2\text{ k}\Omega$ | 0.1% | 25°C | 2.9 | | μs |
| | | $V_{DD} = 5\text{ V}, 15\text{ V}$, $V_{(STEP)PP} = 1\text{ V}$, $A_V = -1$, $C_L = 47\text{ pF}$, $R_L = 2\text{ k}\Omega$ | 0.1% | | 2 | | |

† Full range is -40°C to 125°C . If not specified, full range is -40°C to 125°C .

noise/distortion performance

| PARAMETER | | TEST CONDITIONS | T_A | MIN | TYP | MAX | UNIT |
|-----------|--------------------------------------|--|-------------|------|-------|------------------------------|------|
| THD + N | Total harmonic distortion plus noise | $V_{DD} = 2.7\text{ V}$, $V_{O(PP)} = V_{DD}/2\text{ V}$, $R_L = 2\text{ k}\Omega$, $f = 10\text{ kHz}$ | $A_V = 1$ | 25°C | 0.02% | | |
| | | | $A_V = 10$ | | 0.05% | | |
| | | | $A_V = 100$ | | 0.18% | | |
| | | $V_{DD} = 5\text{ V}, \pm 5\text{ V}$, $V_{O(PP)} = V_{DD}/2\text{ V}$, $R_L = 2\text{ k}\Omega$, $f = 10\text{ K}$ | $A_V = 1$ | 25°C | 0.02% | | |
| | | | $A_V = 10$ | | 0.09% | | |
| | | | $A_V = 100$ | | 0.5% | | |
| V_n | Equivalent input noise voltage | $f = 1\text{ kHz}$ | 25°C | 39 | | $\text{nV}/\sqrt{\text{Hz}}$ | |
| | | $f = 10\text{ kHz}$ | | 35 | | | |
| I_n | Equivalent input noise current | $f = 1\text{ kHz}$ | 25°C | 0.6 | | $\text{fA}/\sqrt{\text{Hz}}$ | |



TLV271-Q1, TLV272-Q1, TLV274-Q1
FAMILY OF 550- μ A/Ch 3-MHz RAIL-TO-RAIL OUTPUT
OPERATIONAL AMPLIFIERS

SGLS275A – OCTOBER 2004 – REVISED JUNE 2008

TYPICAL CHARACTERISTICS

Table of Graphs

| | | | FIGURE |
|-------------|--|------------------------------|---------------|
| CMRR | Common-mode rejection ratio | vs Frequency | 1 |
| | Input bias and offset current | vs Free-air temperature | 2 |
| V_{OL} | Low-level output voltage | vs Low-level output current | 3, 5, 7 |
| V_{OH} | High-level output voltage | vs High-level output current | 4, 6, 8 |
| $V_{O(PP)}$ | Peak-to-peak output voltage | vs Frequency | 9 |
| I_{DD} | Supply current | vs Supply voltage | 10 |
| PSRR | Power supply rejection ratio | vs Frequency | 11 |
| A_{VD} | Differential voltage gain & phase | vs Frequency | 12 |
| | Gain-bandwidth product | vs Free-air temperature | 13 |
| SR | Slew rate | vs Supply voltage | 14 |
| | | vs Free-air temperature | 15 |
| ϕ_m | Phase margin | vs Capacitive load | 16 |
| V_n | Equivalent input noise voltage | vs Frequency | 17 |
| | Voltage-follower large-signal pulse response | | 18, 19 |
| | Voltage-follower small-signal pulse response | | 20 |
| | Inverting large-signal response | | 21, 22 |
| | Inverting small-signal response | | 23 |
| | Crosstalk | vs Frequency | 24 |



TLV271-Q1, TLV272-Q1, TLV274-Q1 FAMILY OF 550- μ A/Ch 3-MHz RAIL-TO-RAIL OUTPUT OPERATIONAL AMPLIFIERS

SGLS275A – OCTOBER 2004 – REVISED JUNE 2008

TYPICAL CHARACTERISTICS

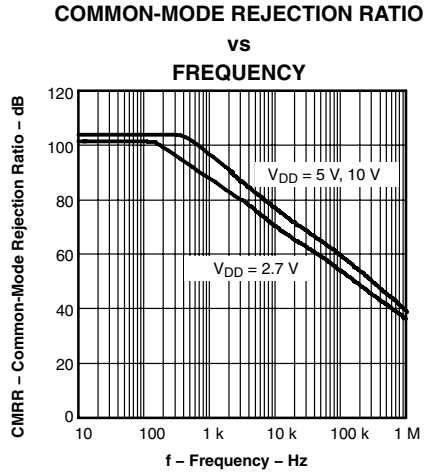

Figure 1

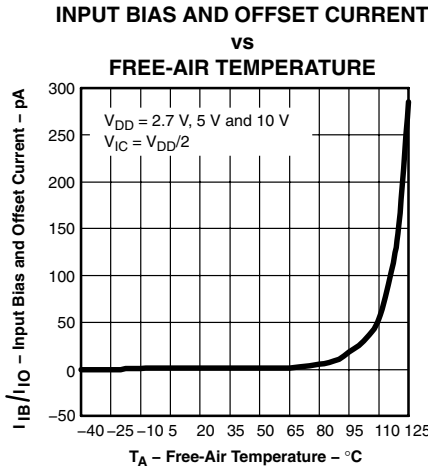

Figure 2

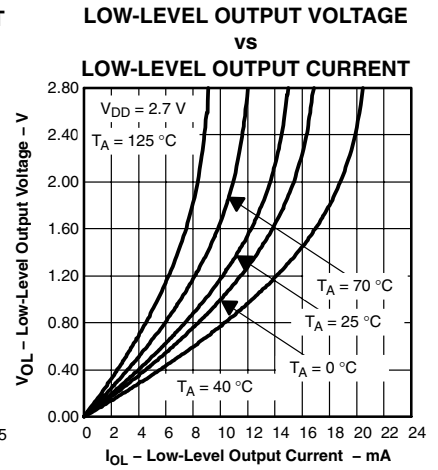

Figure 3

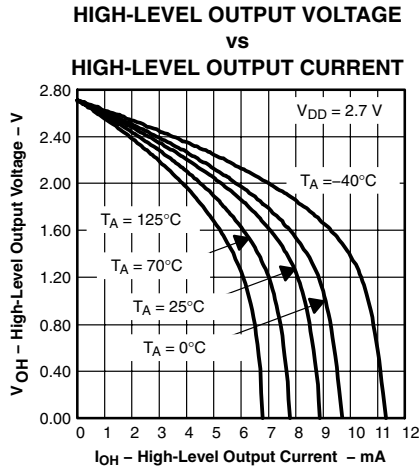

Figure 4

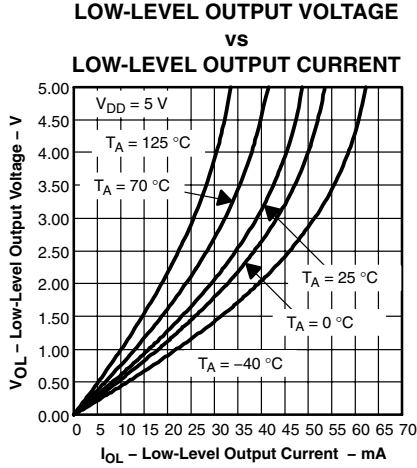

Figure 5

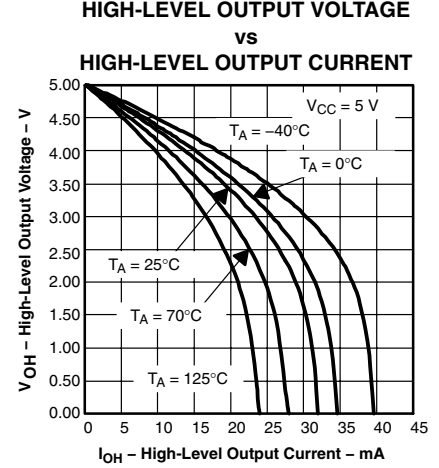

Figure 6

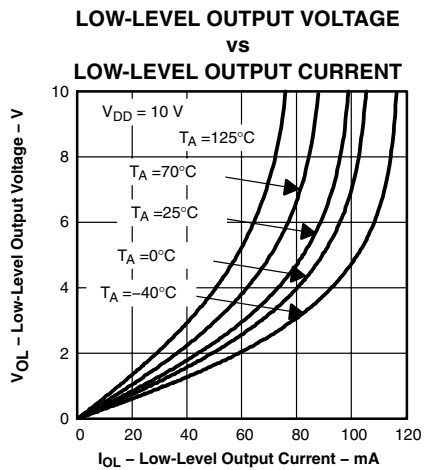

Figure 7

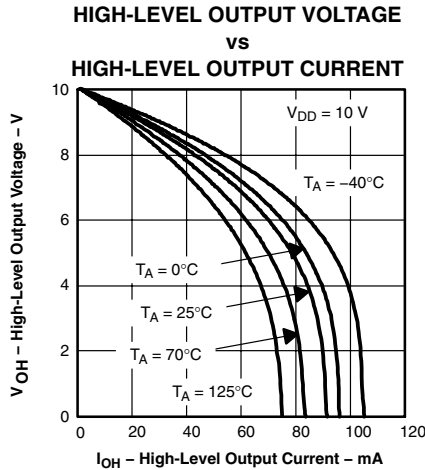

Figure 8

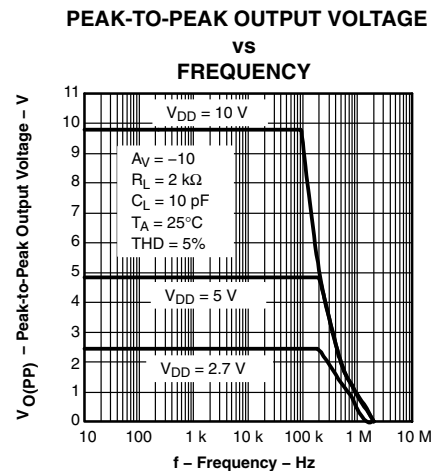

Figure 9

TLV271-Q1, TLV272-Q1, TLV274-Q1 FAMILY OF 550- μ A/Ch 3-MHz RAIL-TO-RAIL OUTPUT OPERATIONAL AMPLIFIERS

SGLS275A – OCTOBER 2004 – REVISED JUNE 2008

TYPICAL CHARACTERISTICS

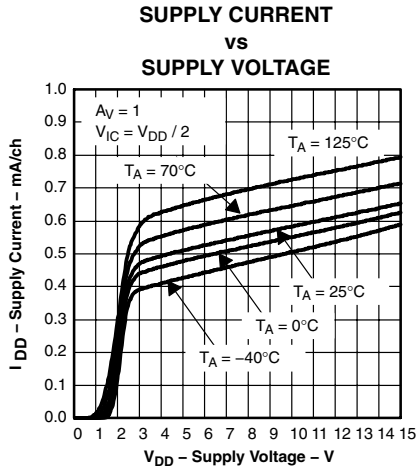

Figure 10

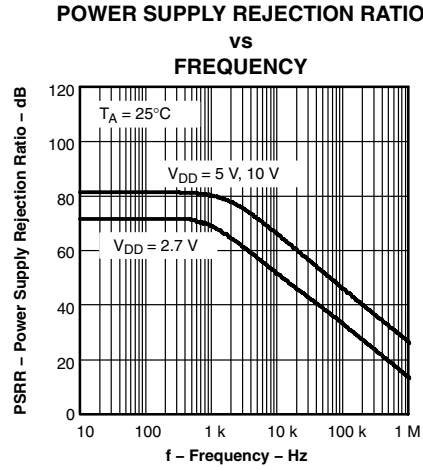

Figure 11

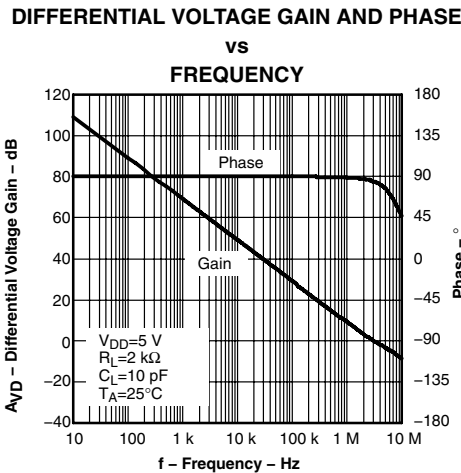

Figure 12

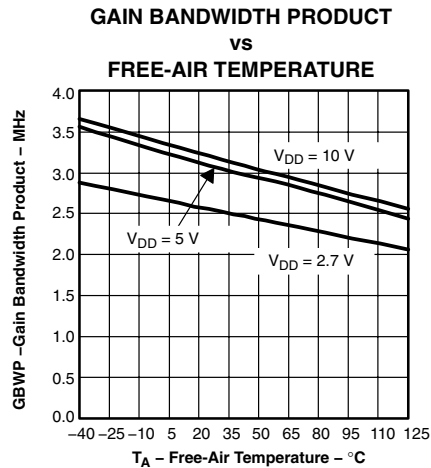

Figure 13

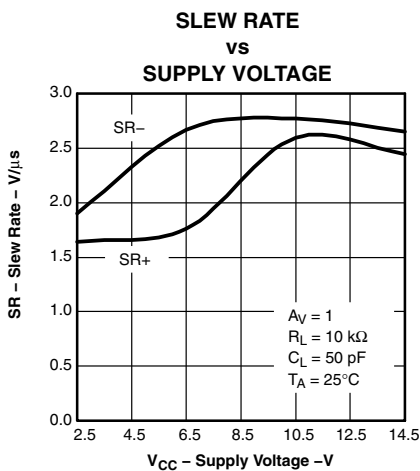

Figure 14

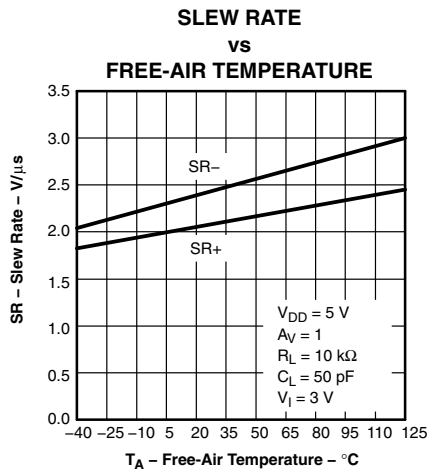

Figure 15

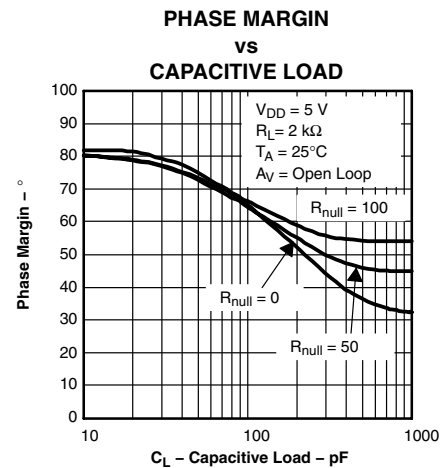

Figure 16



TYPICAL CHARACTERISTICS

EQUIVALENT INPUT NOISE VOLTAGE
 vs
 FREQUENCY

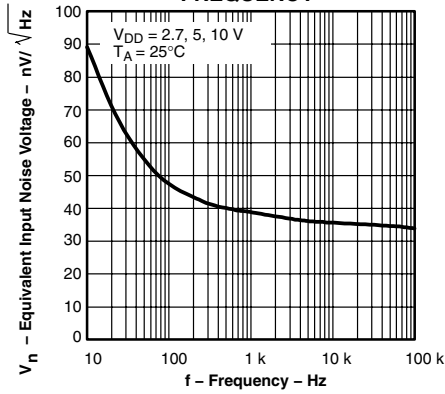

Figure 17

VOLTAGE-FOLLOWER LARGE-SIGNAL
 PULSE RESPONSE

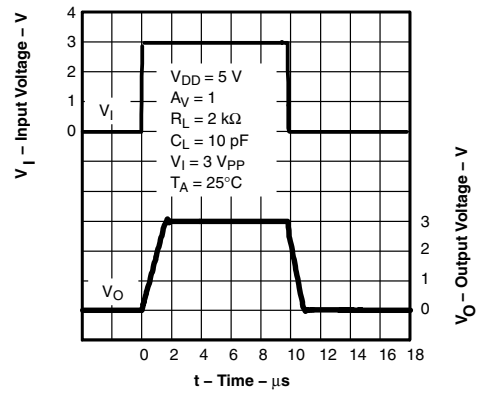

Figure 18

VOLTAGE-FOLLOWER LARGE-SIGNAL
 PULSE RESPONSE

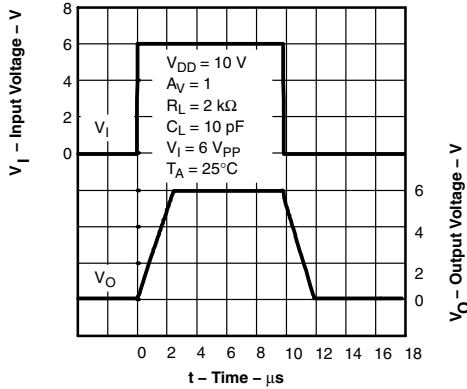

Figure 19

VOLTAGE-FOLLOWER SMALL-SIGNAL
 PULSE RESPONSE

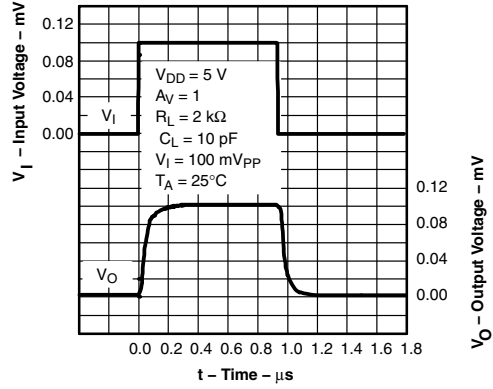

Figure 20

INVERTING LARGE-SIGNAL RESPONSE

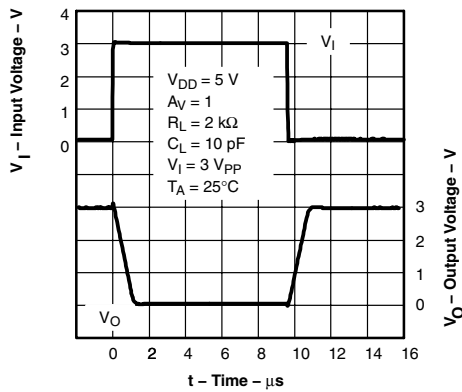

Figure 21

INVERTING LARGE-SIGNAL RESPONSE

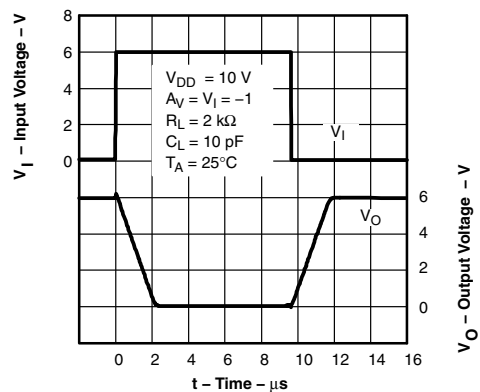

Figure 22

TLV271-Q1, TLV272-Q1, TLV274-Q1 FAMILY OF 550- μ A/Ch 3-MHz RAIL-TO-RAIL OUTPUT OPERATIONAL AMPLIFIERS

SGLS275A – OCTOBER 2004 – REVISED JUNE 2008

TYPICAL CHARACTERISTICS

INVERTING SMALL-SIGNAL RESPONSE

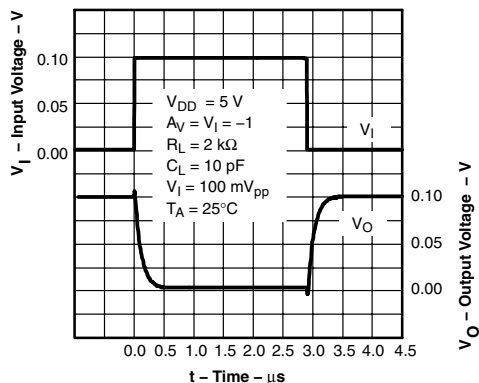

Figure 23

CROSSTALK
vs
FREQUENCY

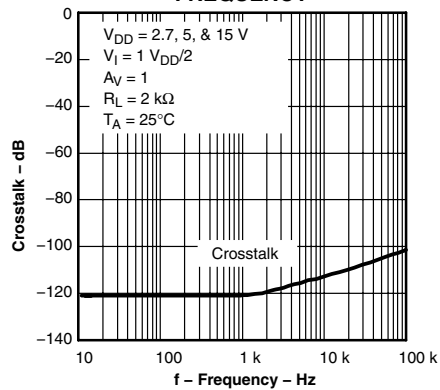

Figure 24

APPLICATION INFORMATION

driving a capacitive load

When the amplifier is configured in this manner, capacitive loading directly on the output decreases the device's phase margin leading to high frequency ringing or oscillations. Therefore, for capacitive loads of greater than 10 pF, it is recommended that a resistor be placed in series (R_{NULL}) with the output of the amplifier, as shown in Figure 25. A minimum value of 20 Ω should work well for most applications.

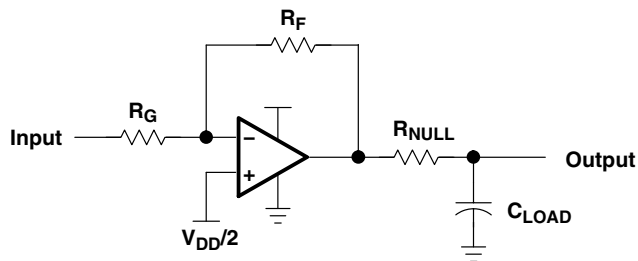

Figure 25. Driving a Capacitive Load

APPLICATION INFORMATION

offset voltage

The output offset voltage (V_{OO}) is the sum of the input offset voltage (V_{IO}) and both input bias currents (I_{IB}) times the corresponding gains. The following schematic and formula can be used to calculate the output offset voltage:

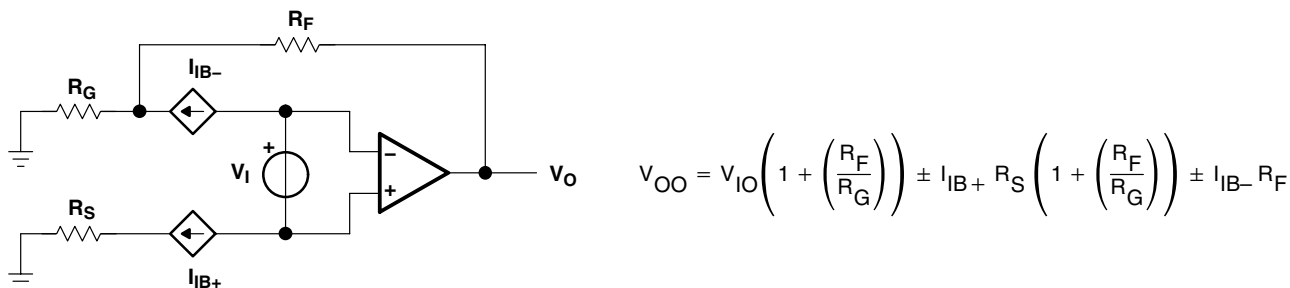

Figure 26. Output Offset Voltage Model

general configurations

When receiving low-level signals, limiting the bandwidth of the incoming signals into the system is often required. The simplest way to accomplish this is to place an RC filter at the noninverting terminal of the amplifier (see Figure 27).

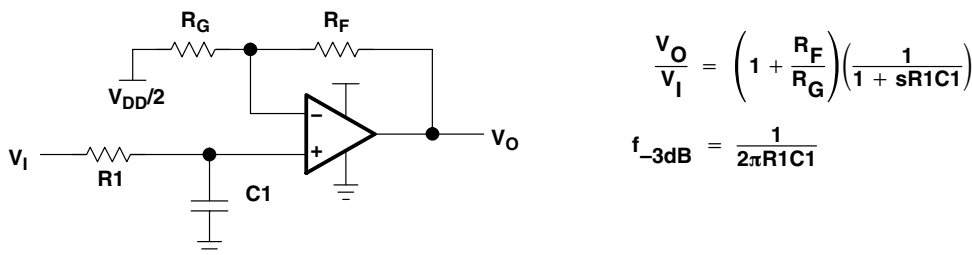

Figure 27. Single-Pole Low-Pass Filter

If even more attenuation is needed, a multiple pole filter is required. The Sallen-Key filter can be used for this task. For the best results, the amplifier should have a bandwidth that is 8 to 10 times the filter frequency bandwidth. Failure to do this can result in phase shift of the amplifier.

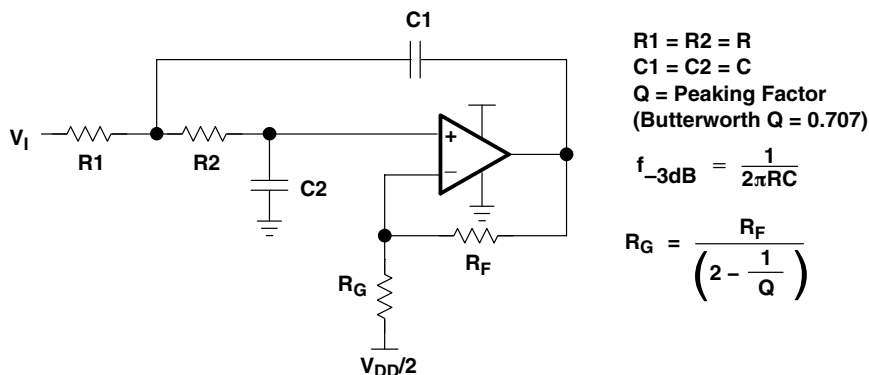

Figure 28. 2-Pole Low-Pass Sallen-Key Filter

TLV271-Q1, TLV272-Q1, TLV274-Q1 FAMILY OF 550- μ A/Ch 3-MHz RAIL-TO-RAIL OUTPUT OPERATIONAL AMPLIFIERS

SGLS275A – OCTOBER 2004 – REVISED JUNE 2008

APPLICATION INFORMATION

circuit layout considerations

To achieve the levels of high performance of the TLV27x, follow proper printed-circuit board design techniques. A general set of guidelines is given in the following.

- Ground planes—It is highly recommended that a ground plane be used on the board to provide all components with a low inductive ground connection. However, in the areas of the amplifier inputs and output, the ground plane can be removed to minimize the stray capacitance.
- Proper power supply decoupling—Use a 6.8- μ F tantalum capacitor in parallel with a 0.1- μ F ceramic capacitor on each supply terminal. It may be possible to share the tantalum among several amplifiers depending on the application, but a 0.1- μ F ceramic capacitor should always be used on the supply terminal of every amplifier. In addition, the 0.1- μ F capacitor should be placed as close as possible to the supply terminal. As this distance increases, the inductance in the connecting trace makes the capacitor less effective. The designer should strive for distances of less than 0.1 inches between the device power terminals and the ceramic capacitors.
- Sockets—Sockets can be used but are not recommended. The additional lead inductance in the socket pins will often lead to stability problems. Surface-mount packages soldered directly to the printed-circuit board is the best implementation.
- Short trace runs/compact part placements—Optimum high performance is achieved when stray series inductance has been minimized. To realize this, the circuit layout should be made as compact as possible, thereby minimizing the length of all trace runs. Particular attention should be paid to the inverting input of the amplifier. Its length should be kept as short as possible. This helps to minimize stray capacitance at the input of the amplifier.
- Surface-mount passive components—Using surface-mount passive components is recommended for high performance amplifier circuits for several reasons. First, because of the extremely low lead inductance of surface-mount components, the problem with stray series inductance is greatly reduced. Second, the small size of surface-mount components naturally leads to a more compact layout thereby minimizing both stray inductance and capacitance. If leaded components are used, it is recommended that the lead lengths be kept as short as possible.



POST OFFICE BOX 655303 • DALLAS, TEXAS 75265

APPLICATION INFORMATION

general power dissipation considerations

For a given θ_{JA} , the maximum power dissipation is shown in Figure 29 and is calculated by the following formula:

$$P_D = \left(\frac{T_{MAX} - T_A}{\theta_{JA}} \right)$$

Where:

- P_D = Maximum power dissipation of TLV27x IC (watts)
- T_{MAX} = Absolute maximum junction temperature (150°C)
- T_A = Free-ambient air temperature (°C)
- θ_{JA} = $\theta_{JC} + \theta_{CA}$
- θ_{JC} = Thermal coefficient from junction to case
- θ_{CA} = Thermal coefficient from case to ambient air (°C/W)

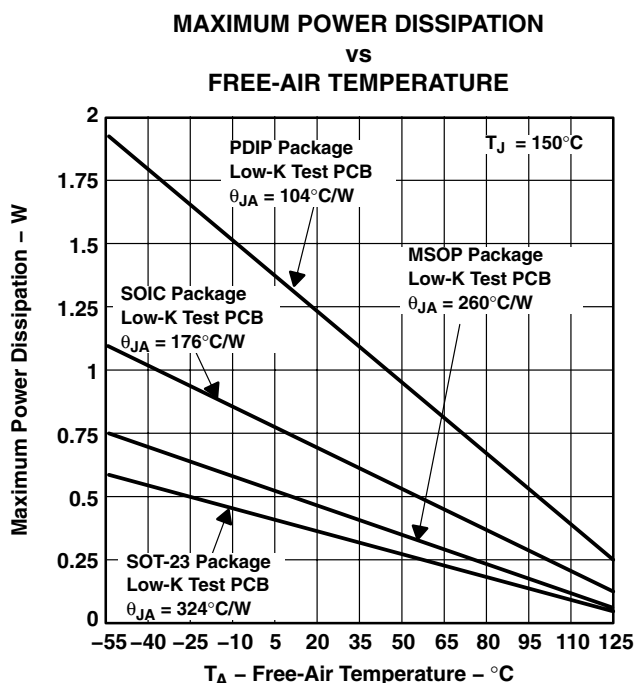

NOTE A: Results are with no air flow and using JEDEC Standard Low-K test PCB.

Figure 29. Maximum Power Dissipation vs Free-Air Temperature

TLV271-Q1, TLV272-Q1, TLV274-Q1 FAMILY OF 550- μ A/Ch 3-MHz RAIL-TO-RAIL OUTPUT OPERATIONAL AMPLIFIERS

SGLS275A – OCTOBER 2004 – REVISED JUNE 2008

APPLICATION INFORMATION

macromodel information

Macromodel information provided was derived using Microsim *Parts*™ Release 9.1, the model generation software used with Microsim *PSpice*™. The Boyle macromodel (see Note 2) and subcircuit in Figure 30 are generated using TLV27x typical electrical and operating characteristics at $T_A = 25^\circ\text{C}$. Using this information, output simulations of the following key parameters can be generated to a tolerance of 20% (in most cases):

- Maximum positive output voltage swing
- Maximum negative output voltage swing
- Slew rate
- Quiescent power dissipation
- Input bias current
- Open-loop voltage amplification
- Unity-gain frequency
- Common-mode rejection ratio
- Phase margin
- DC output resistance
- AC output resistance
- Short-circuit output current limit

NOTE 2: G. R. Boyle, B. M. Cohn, D. O. Pederson, and J. E. Solomon, "Macromodeling of Integrated Circuit Operational Amplifiers," *IEEE Journal of Solid-State Circuits*, SC-9, 353 (1974).

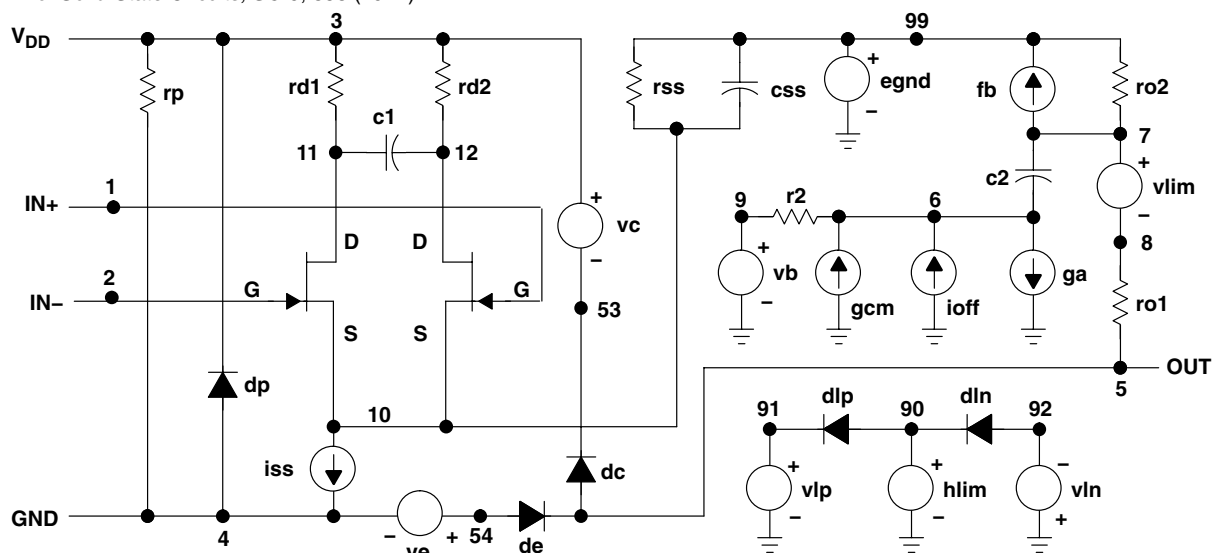

*DEVICE=amp_tlv27x_highVdd,OP AMP,NJF,INT
* amp_tlv_27x_highVdd operational amplifier "macromodel"
* subcircuit updated using Model Editor release 9.1 on 05/15/00
* at 14:40 Model Editor is an OrCAD product.

* connections:

| | | | |
|--|--|--|-----------------------|
| | | | non-inverting input |
| | | | inverting input |
| | | | positive power supply |
| | | | negative power supply |
| | | | output |

.subckt amp_tlv27x_highVdd 1 2 3 4 5

| | | | |
|------|----|----|-----------------------------|
| c1 | 11 | 12 | 457.48E-15 |
| c2 | 6 | 7 | 5.0000E-12 |
| css | 10 | 99 | 1.1431E-12 |
| dc | 5 | 53 | dc |
| de | 54 | 5 | dc |
| djp | 90 | 91 | dx |
| dln | 92 | 90 | dx |
| dp | 4 | 3 | dx |
| egnd | 99 | 0 | poly(2) (3,0) (4,0) 0 .5 .5 |
| fb | 7 | 99 | poly(5) vb vc ve vlp vln 0 |

| | | | |
|--------|-----|----|--|
| ga | 6 | 0 | 11 12 16.272E-6 |
| gcm | 0 | 6 | 10 99 6.8698E-9 |
| iss | 10 | 4 | dc 1.3371E-6 |
| hlim | 90 | 0 | vlim 1K |
| j1 | 11 | 2 | 10 jx1 |
| J2 | 12 | 1 | 10 jx2 |
| r2 | 6 | 9 | 100.00E3 |
| rd1 | 3 | 11 | 61.456E3 |
| rd2 | 3 | 12 | 61.456E3 |
| ro1 | 8 | 5 | 10 |
| ro2 | 7 | 99 | 10 |
| rp | 3 | 4 | 150.51E3 |
| rss | 10 | 99 | 149.58E6 |
| vb | 9 | 0 | dc 0 |
| vc | 3 | 53 | dc .78905 |
| ve | 54 | 4 | dc .78905 |
| vlim | 7 | 8 | dc 0 |
| vlp | 91 | 0 | dc 14.200 |
| vln | 0 | 92 | dc 14.200 |
| .model | dx | | D(Is=800.00E-18) |
| .model | dy | | D(Is=800.00E-18 Rs=1m Cjo=10p) |
| .model | jx1 | | NJF(Is=500.00E-15 Beta=198.03E-6 Vto=-1) |
| .model | jx2 | | NJF(Is=500.00E-15 Beta=198.03E-6 Vto=-1) |
| .ends | | | |

Figure 30. Boyle Macromodel and Subcircuit

PSpice and Parts are trademarks of MicroSim Corporation.



PACKAGING INFORMATION

| Orderable Device | Status (1) | Package Type | Package Drawing | Pins | Package Qty | Eco Plan (2) | Lead/Ball Finish | MSL Peak Temp (3) | Op Temp (°C) | Top-Side Markings (4) | Samples |
|------------------|---------------|--------------|-----------------|------|-------------|-------------------------|------------------|----------------------|--------------|--------------------------|-------------------------|
| TLV271QDBVRQ1 | ACTIVE | SOT-23 | DBV | 5 | 3000 | Green (RoHS & no Sb/Br) | CU NIPDAU | Level-1-260C-UNLIM | -40 to 125 | 271Q | Samples |
| TLV271QDRG4Q1 | ACTIVE | SOIC | D | 8 | 2500 | Green (RoHS & no Sb/Br) | CU NIPDAU | Level-1-260C-UNLIM | -40 to 125 | T271Q1 | Samples |
| TLV271QDRQ1 | ACTIVE | SOIC | D | 8 | 2500 | Green (RoHS & no Sb/Br) | CU NIPDAU | Level-1-260C-UNLIM | -40 to 125 | T271Q1 | Samples |
| TLV272QDRG4Q1 | ACTIVE | SOIC | D | 8 | 2500 | Green (RoHS & no Sb/Br) | CU NIPDAU | Level-1-260C-UNLIM | -40 to 125 | T272Q1 | Samples |
| TLV272QDRQ1 | ACTIVE | SOIC | D | 8 | 2500 | Green (RoHS & no Sb/Br) | CU NIPDAU | Level-1-260C-UNLIM | -40 to 125 | T272Q1 | Samples |
| TLV274QDRG4Q1 | ACTIVE | SOIC | D | 14 | 2500 | Green (RoHS & no Sb/Br) | CU NIPDAU | Level-1-260C-UNLIM | -40 to 125 | TLV274Q1 | Samples |
| TLV274QDRQ1 | ACTIVE | SOIC | D | 14 | 2500 | Green (RoHS & no Sb/Br) | CU NIPDAU | Level-1-260C-UNLIM | -40 to 125 | TLV274Q1 | Samples |
| TLV274QPWRG4Q1 | ACTIVE | TSSOP | PW | 14 | 2000 | Green (RoHS & no Sb/Br) | CU NIPDAU | Level-1-260C-UNLIM | -40 to 125 | TLV274Q | Samples |
| TLV274QPWRQ1 | OBSOLETE | TSSOP | PW | 14 | | TBD | Call TI | Call TI | -40 to 125 | TLV274Q | |

(1) The marketing status values are defined as follows:

ACTIVE: Product device recommended for new designs.

LIFEBUY: TI has announced that the device will be discontinued, and a lifetime-buy period is in effect.

NRND: Not recommended for new designs. Device is in production to support existing customers, but TI does not recommend using this part in a new design.

PREVIEW: Device has been announced but is not in production. Samples may or may not be available.

OBSOLETE: TI has discontinued the production of the device.

(2) Eco Plan - The planned eco-friendly classification: Pb-Free (RoHS), Pb-Free (RoHS Exempt), or Green (RoHS & no Sb/Br) - please check <http://www.ti.com/productcontent> for the latest availability information and additional product content details.

TBD: The Pb-Free/Green conversion plan has not been defined.

Pb-Free (RoHS): TI's terms "Lead-Free" or "Pb-Free" mean semiconductor products that are compatible with the current RoHS requirements for all 6 substances, including the requirement that lead not exceed 0.1% by weight in homogeneous materials. Where designed to be soldered at high temperatures, TI Pb-Free products are suitable for use in specified lead-free processes.

Pb-Free (RoHS Exempt): This component has a RoHS exemption for either 1) lead-based flip-chip solder bumps used between the die and package, or 2) lead-based die adhesive used between the die and leadframe. The component is otherwise considered Pb-Free (RoHS compatible) as defined above.

Green (RoHS & no Sb/Br): TI defines "Green" to mean Pb-Free (RoHS compatible), and free of Bromine (Br) and Antimony (Sb) based flame retardants (Br or Sb do not exceed 0.1% by weight in homogeneous material)

(3) MSL, Peak Temp. -- The Moisture Sensitivity Level rating according to the JEDEC industry standard classifications, and peak solder temperature.

⁽⁴⁾ Multiple Top-Side Markings will be inside parentheses. Only one Top-Side Marking contained in parentheses and separated by a "~" will appear on a device. If a line is indented then it is a continuation of the previous line and the two combined represent the entire Top-Side Marking for that device.

Important Information and Disclaimer: The information provided on this page represents TI's knowledge and belief as of the date that it is provided. TI bases its knowledge and belief on information provided by third parties, and makes no representation or warranty as to the accuracy of such information. Efforts are underway to better integrate information from third parties. TI has taken and continues to take reasonable steps to provide representative and accurate information but may not have conducted destructive testing or chemical analysis on incoming materials and chemicals. TI and TI suppliers consider certain information to be proprietary, and thus CAS numbers and other limited information may not be available for release.

In no event shall TI's liability arising out of such information exceed the total purchase price of the TI part(s) at issue in this document sold by TI to Customer on an annual basis.

OTHER QUALIFIED VERSIONS OF TLV271-Q1, TLV272-Q1, TLV274-Q1 :

- Catalog: [TLV271](#), [TLV272](#), [TLV274](#)

NOTE: Qualified Version Definitions:

- Catalog - TI's standard catalog product

TAPE AND REEL INFORMATION

QUADRANT ASSIGNMENTS FOR PIN 1 ORIENTATION IN TAPE

*All dimensions are nominal

| Device | Package Type | Package Drawing | Pins | SPQ | Reel Diameter (mm) | Reel Width W1 (mm) | A0 (mm) | B0 (mm) | K0 (mm) | P1 (mm) | W (mm) | Pin1 Quadrant |
|----------------|--------------|-----------------|------|------|--------------------|--------------------|---------|---------|---------|---------|--------|---------------|
| TLV271QDBVRQ1 | SOT-23 | DBV | 5 | 3000 | 180.0 | 9.0 | 3.15 | 3.2 | 1.4 | 4.0 | 8.0 | Q3 |
| TLV274QPWRG4Q1 | TSSOP | PW | 14 | 2000 | 330.0 | 12.4 | 6.9 | 5.6 | 1.6 | 8.0 | 12.0 | Q1 |

TAPE AND REEL BOX DIMENSIONS



*All dimensions are nominal

| Device | Package Type | Package Drawing | Pins | SPQ | Length (mm) | Width (mm) | Height (mm) |
|----------------|--------------|-----------------|------|------|-------------|------------|-------------|
| TLV271QDBVRQ1 | SOT-23 | DBV | 5 | 3000 | 182.0 | 182.0 | 20.0 |
| TLV274QPWRG4Q1 | TSSOP | PW | 14 | 2000 | 367.0 | 367.0 | 35.0 |

MECHANICAL DATA

DBV (R-PDSO-G5)

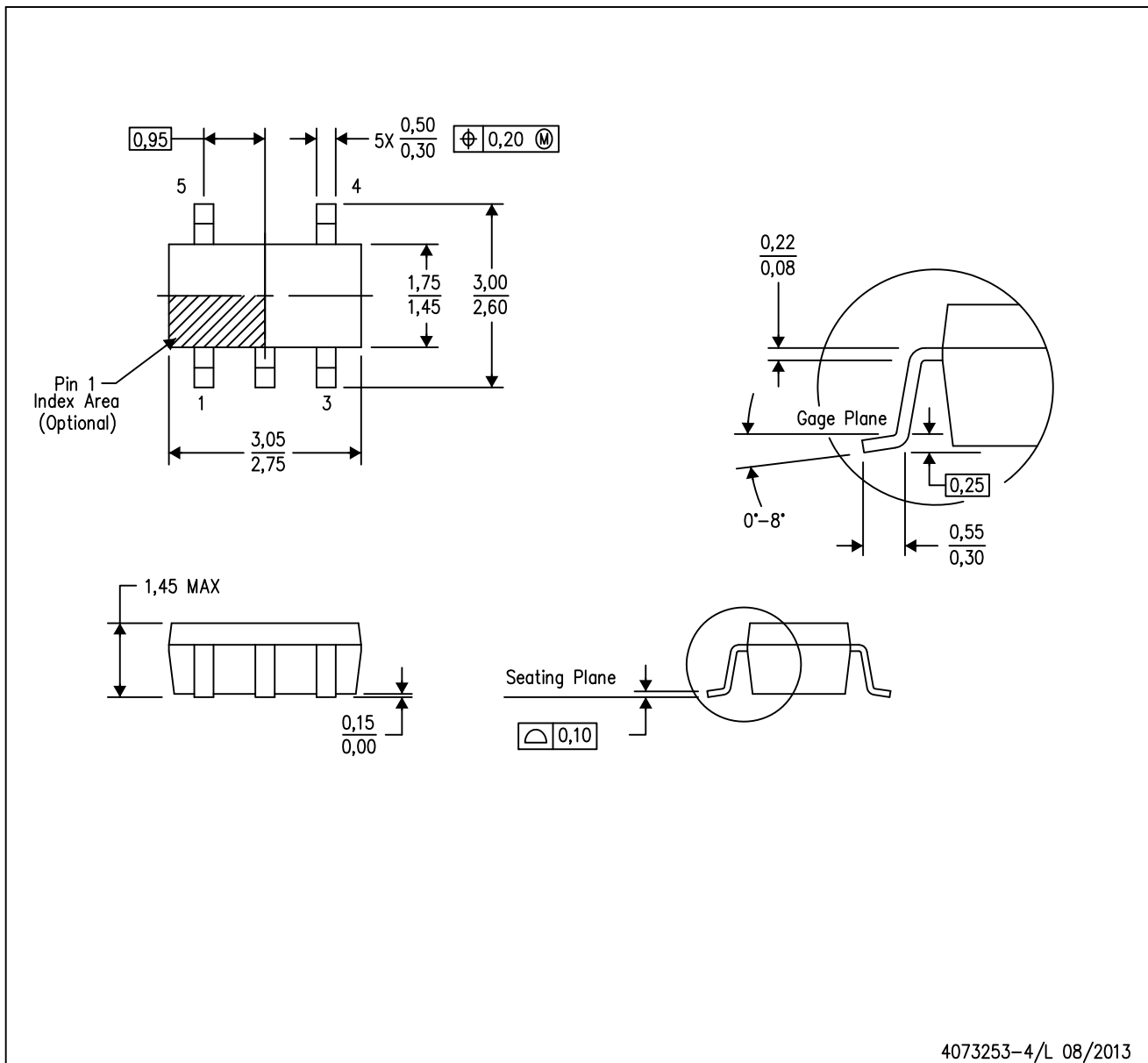
PLASTIC SMALL-OUTLINE PACKAGE



- NOTES:
- All linear dimensions are in millimeters.
 - This drawing is subject to change without notice.
 - Body dimensions do not include mold flash or protrusion. Mold flash and protrusion shall not exceed 0.15 per side.
 - Falls within JEDEC MO-178 Variation AA.

D (R-PDSO-G14)

PLASTIC SMALL OUTLINE



- NOTES:
- A. All linear dimensions are in inches (millimeters).
 - B. This drawing is subject to change without notice.
 -  Body length does not include mold flash, protrusions, or gate burrs. Mold flash, protrusions, or gate burrs shall not exceed 0.006 (0,15) each side.
 -  Body width does not include interlead flash. Interlead flash shall not exceed 0.017 (0,43) each side.
 - E. Reference JEDEC MS-012 variation AB.

D (R-PDSO-G14)

PLASTIC SMALL OUTLINE



4211283-3/E 08/12

- NOTES:
- All linear dimensions are in millimeters.
 - This drawing is subject to change without notice.
 - Publication IPC-7351 is recommended for alternate designs.
 - Laser cutting apertures with trapezoidal walls and also rounding corners will offer better paste release. Customers should contact their board assembly site for stencil design recommendations. Refer to IPC-7525 for other stencil recommendations.
 - Customers should contact their board fabrication site for solder mask tolerances between and around signal pads.

PW (R-PDSO-G14)

PLASTIC SMALL OUTLINE

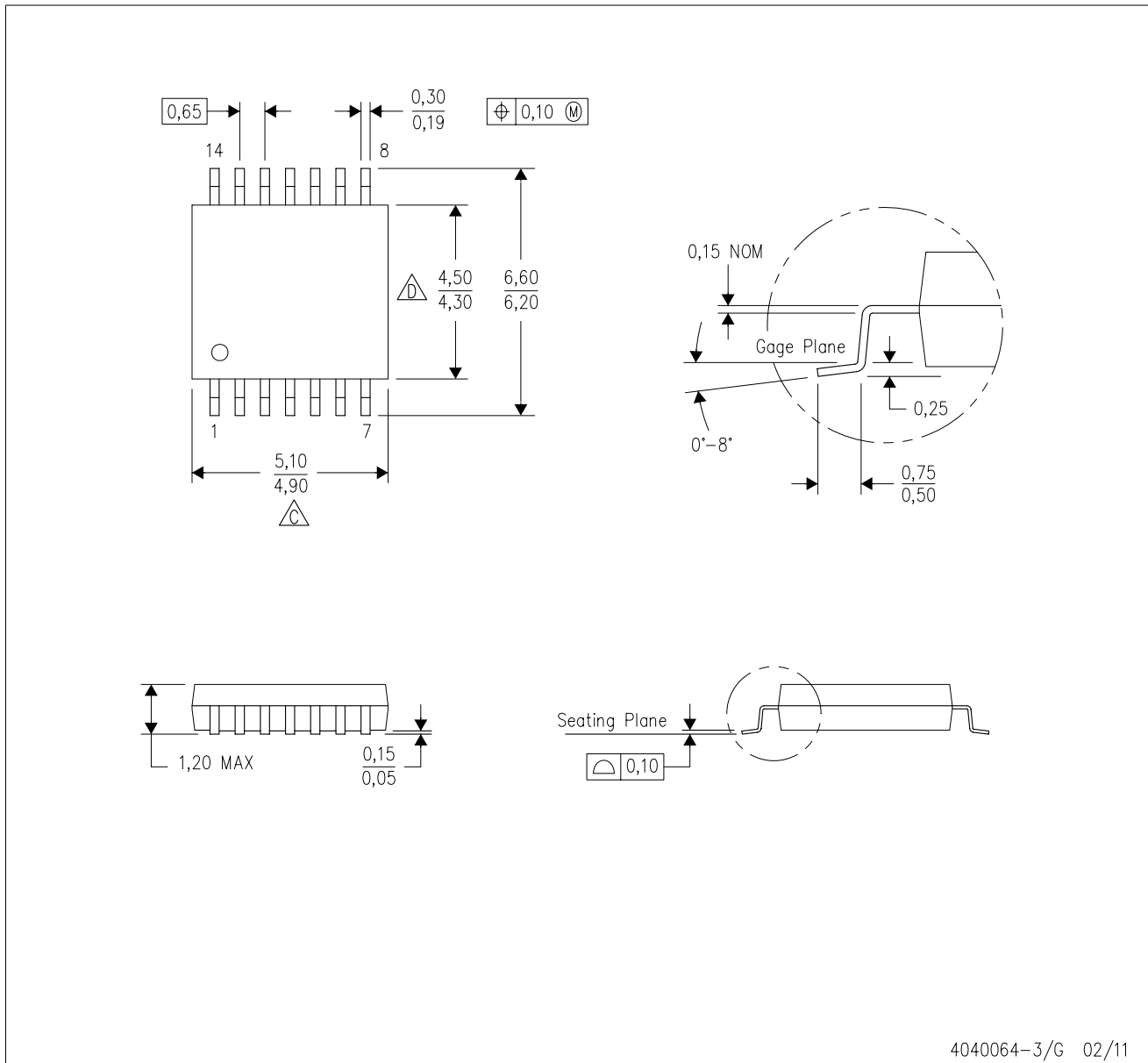

4040064-3/G 02/11

- NOTES:
- A. All linear dimensions are in millimeters. Dimensioning and tolerancing per ASME Y14.5M-1994.
 - B. This drawing is subject to change without notice.
 -  C. Body length does not include mold flash, protrusions, or gate burrs. Mold flash, protrusions, or gate burrs shall not exceed 0,15 each side.
 -  D. Body width does not include interlead flash. Interlead flash shall not exceed 0,25 each side.
 - E. Falls within JEDEC MO-153

PW (R-PDSO-G14)

PLASTIC SMALL OUTLINE

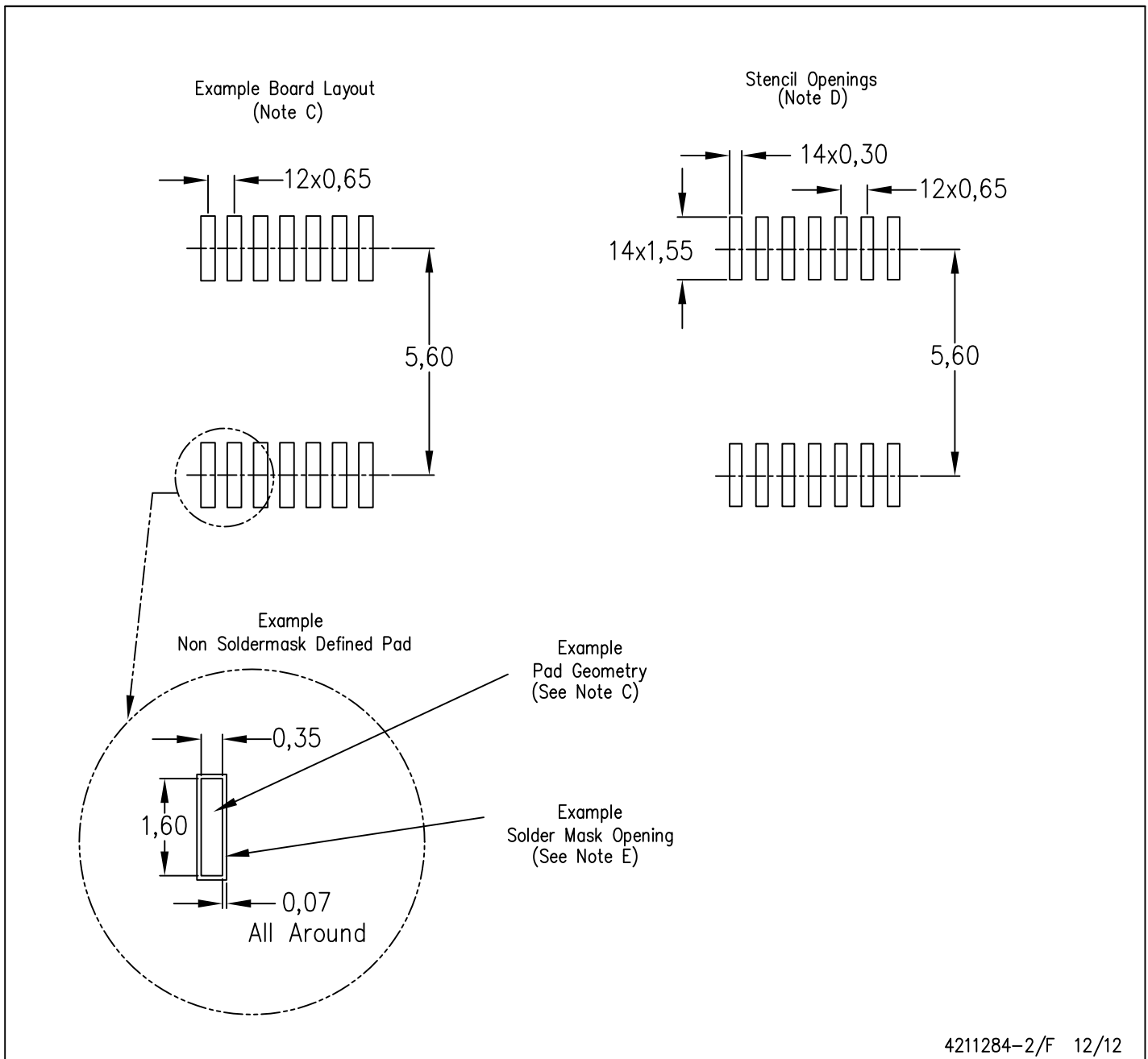

- NOTES:
- A. All linear dimensions are in millimeters.
 - B. This drawing is subject to change without notice.
 - C. Publication IPC-7351 is recommended for alternate designs.
 - D. Laser cutting apertures with trapezoidal walls and also rounding corners will offer better paste release. Customers should contact their board assembly site for stencil design recommendations. Refer to IPC-7525 for other stencil recommendations.
 - E. Customers should contact their board fabrication site for solder mask tolerances between and around signal pads.

D (R-PDSO-G8)

PLASTIC SMALL OUTLINE



D (R-PDSO-G8)

PLASTIC SMALL OUTLINE



4211283-2/E 08/12

- NOTES:
- A. All linear dimensions are in millimeters.
 - B. This drawing is subject to change without notice.
 - C. Publication IPC-7351 is recommended for alternate designs.
 - D. Laser cutting apertures with trapezoidal walls and also rounding corners will offer better paste release. Customers should contact their board assembly site for stencil design recommendations. Refer to IPC-7525 for other stencil recommendations.
 - E. Customers should contact their board fabrication site for solder mask tolerances between and around signal pads.

IMPORTANT NOTICE

Texas Instruments Incorporated and its subsidiaries (TI) reserve the right to make corrections, enhancements, improvements and other changes to its semiconductor products and services per JESD46, latest issue, and to discontinue any product or service per JESD48, latest issue. Buyers should obtain the latest relevant information before placing orders and should verify that such information is current and complete. All semiconductor products (also referred to herein as "components") are sold subject to TI's terms and conditions of sale supplied at the time of order acknowledgment.

TI warrants performance of its components to the specifications applicable at the time of sale, in accordance with the warranty in TI's terms and conditions of sale of semiconductor products. Testing and other quality control techniques are used to the extent TI deems necessary to support this warranty. Except where mandated by applicable law, testing of all parameters of each component is not necessarily performed.

TI assumes no liability for applications assistance or the design of Buyers' products. Buyers are responsible for their products and applications using TI components. To minimize the risks associated with Buyers' products and applications, Buyers should provide adequate design and operating safeguards.

TI does not warrant or represent that any license, either express or implied, is granted under any patent right, copyright, mask work right, or other intellectual property right relating to any combination, machine, or process in which TI components or services are used. Information published by TI regarding third-party products or services does not constitute a license to use such products or services or a warranty or endorsement thereof. Use of such information may require a license from a third party under the patents or other intellectual property of the third party, or a license from TI under the patents or other intellectual property of TI.

Reproduction of significant portions of TI information in TI data books or data sheets is permissible only if reproduction is without alteration and is accompanied by all associated warranties, conditions, limitations, and notices. TI is not responsible or liable for such altered documentation. Information of third parties may be subject to additional restrictions.

Resale of TI components or services with statements different from or beyond the parameters stated by TI for that component or service voids all express and any implied warranties for the associated TI component or service and is an unfair and deceptive business practice. TI is not responsible or liable for any such statements.

Buyer acknowledges and agrees that it is solely responsible for compliance with all legal, regulatory and safety-related requirements concerning its products, and any use of TI components in its applications, notwithstanding any applications-related information or support that may be provided by TI. Buyer represents and agrees that it has all the necessary expertise to create and implement safeguards which anticipate dangerous consequences of failures, monitor failures and their consequences, lessen the likelihood of failures that might cause harm and take appropriate remedial actions. Buyer will fully indemnify TI and its representatives against any damages arising out of the use of any TI components in safety-critical applications.

In some cases, TI components may be promoted specifically to facilitate safety-related applications. With such components, TI's goal is to help enable customers to design and create their own end-product solutions that meet applicable functional safety standards and requirements. Nonetheless, such components are subject to these terms.

No TI components are authorized for use in FDA Class III (or similar life-critical medical equipment) unless authorized officers of the parties have executed a special agreement specifically governing such use.

Only those TI components which TI has specifically designated as military grade or "enhanced plastic" are designed and intended for use in military/aerospace applications or environments. Buyer acknowledges and agrees that any military or aerospace use of TI components which have **not** been so designated is solely at the Buyer's risk, and that Buyer is solely responsible for compliance with all legal and regulatory requirements in connection with such use.

TI has specifically designated certain components as meeting ISO/TS16949 requirements, mainly for automotive use. In any case of use of non-designated products, TI will not be responsible for any failure to meet ISO/TS16949.

Products

| | |
|------------------------------|--|
| Audio | www.ti.com/audio |
| Amplifiers | amplifier.ti.com |
| Data Converters | dataconverter.ti.com |
| DLP® Products | www.dlp.com |
| DSP | dsp.ti.com |
| Clocks and Timers | www.ti.com/clocks |
| Interface | interface.ti.com |
| Logic | logic.ti.com |
| Power Mgmt | power.ti.com |
| Microcontrollers | microcontroller.ti.com |
| RFID | www.ti-rfid.com |
| OMAP Applications Processors | www.ti.com/omap |
| Wireless Connectivity | www.ti.com/wirelessconnectivity |

Applications

| | |
|-------------------------------|--|
| Automotive and Transportation | www.ti.com/automotive |
| Communications and Telecom | www.ti.com/communications |
| Computers and Peripherals | www.ti.com/computers |
| Consumer Electronics | www.ti.com/consumer-apps |
| Energy and Lighting | www.ti.com/energy |
| Industrial | www.ti.com/industrial |
| Medical | www.ti.com/medical |
| Security | www.ti.com/security |
| Space, Avionics and Defense | www.ti.com/space-avionics-defense |
| Video and Imaging | www.ti.com/video |

TI E2E Community

e2e.ti.com