

TPA2000D4

STEREO 2-W CLASS-D AUDIO POWER AMPLIFIER WITH STEREO HP AMPLIFIER

SLOS337A – DECEMBER 2000 – REVISED MAY 2003

- Ideal for Notebook PCs and USB-Powered Speakers
- 2 W Into 4 Ω From 5-V Supply
- Integrated Class-AB Headphone Amplifier
- Second-Generation Modulation Technique
 - Filterless Operation
 - Improved Efficiency
- Low Supply Current . . . 9 mA typ at 5 V
- Shutdown Control . . . < 0.05 μA Typ
- Shutdown Pin Is TTL Compatible
- –40°C to 85°C Operating Temperature Range
- Space-Saving, Thermally-Enhanced PowerPAD™ Packaging

description

The TPA2000D4 is a 2-W stereo bridge-tied-load (BTL) class-D amplifier designed to drive speakers with as low as 4-Ω impedance. The amplifier uses TI's second-generation modulation technique, which results in improved efficiency and SNR, and also allows the device to be connected directly to the speaker without the use of the LC output filter commonly associated with class-D amplifiers (this will result in an EMI which must be shielded at the system level). These features make the device ideal for use in notebook PCs where high-efficiency is needed to extend battery run-time. For speakers powered off the USB bus, the high-efficiency allows for higher output power levels without tripping the USB's overcurrent circuitry.

The gain of the amplifier is controlled by two input terminals, GAIN1, and GAIN0. This allows the amplifier to be configured for a gain of 6, 12, 18, and 23.5 dB. The differential input terminals are high-impedance CMOS inputs, and can be used as summing nodes.

The headphone amplifier is a stereo single-ended (SE) class-AB amplifier which requires two external resistors per channel to set the gain. The MODE pin selects which amplifier is active; the unused amplifier is placed in shutdown to reduce supply current.

Both the class-D BTL amplifier, and the class-AB SE amplifier include depop circuitry to reduce the amount of turnon pop at power up, when cycling SHUTDOWN, and when switching modes of operation.

The TPA2000D4 is available in the 32-pin thermally-enhanced TSSOP package (DAP) which allows stereo 2-W continuous output power levels in 4-Ω loads when placed on a board with proper thermal board design. The TPA2000D4 operates over an ambient temperature range of –40°C to 85°C.

These packages deliver levels of thermal performance that were previously only achievable in TO-220-type packages. Thermal impedances of less than 35°C/W are readily realized in multilayer PCB applications when using the DAP package.

DAP PACKAGE (TOP VIEW)

LINN	□	1	○	32	□	RINN
LINP	□	2		31	□	RINP
HPLIN	□	3		30	□	HPRIN
GAIN0	□	4		29	□	<u>BYPASS</u>
GAIN1	□	5		28	□	<u>SHUTDOWN</u>
PVDDL	□	6		27	□	PVDDR
LOUTP	□	7		26	□	ROUTP
PGNDL	□	8		25	□	PGNDR
PGNDL	□	9		24	□	PGNDR
LOUTN	□	10		23	□	ROUTN
PVDDL	□	11		22	□	PVDDR
HPLGAIN	□	12		21	□	NC
HPLOUT	□	13		20	□	VDD
MODE	□	14		19	□	COSC
HPRGAIN	□	15		18	□	ROSC
HPROUT	□	16		17	□	AGND

NC – No internal connection



Please be aware that an important notice concerning availability, standard warranty, and use in critical applications of Texas Instruments semiconductor products and disclaimers thereto appears at the end of this data sheet.

PowerPAD is a trademark of Texas Instruments.

PRODUCTION DATA information is current as of publication date. Products conform to specifications per the terms of Texas Instruments standard warranty. Production processing does not necessarily include testing of all parameters.



Copyright © 2000–2003, Texas Instruments Incorporated

TPA2000D4 STEREO 2-W CLASS-D AUDIO POWER AMPLIFIER WITH STEREO HP AMPLIFIER

SLOS337A – DECEMBER 2000 – REVISED MAY 2003

AVAILABLE OPTIONS

T _A	PACKAGED DEVICE
	–40°C to 85°C

[†] The DAP package is available taped and reeled. To order a taped and reeled part, add the suffix R to the part number (e.g., TPA2000D4DAPR).

functional schematic

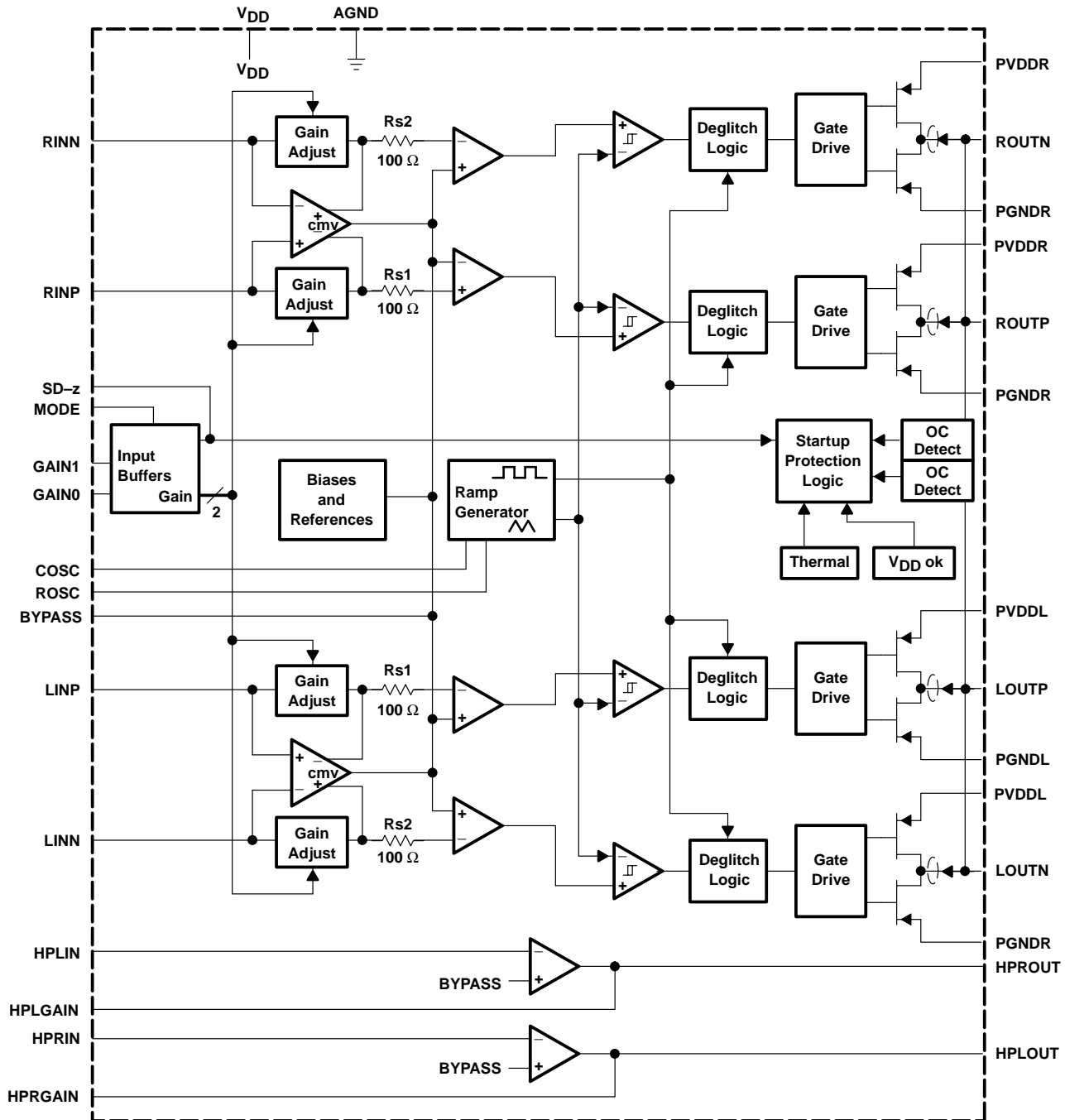

POST OFFICE BOX 655303 • DALLAS, TEXAS 75265

TPA2000D4
STEREO 2-W CLASS-D AUDIO POWER AMPLIFIER
WITH STEREO HP AMPLIFIER

SLOS337A – DECEMBER 2000 – REVISED MAY 2003

Terminal Functions

TERMINAL NAME	NO.	I/O	DESCRIPTION
AGND	17	I	Analog ground
BYPASS	29	I	Connect capacitor to ground for BYPASS voltage filtering
COSC	19	I	Connect capacitor to ground to set oscillation frequency
GAIN0	4	I	Bit 0 of gain control
GAIN1	5	I	Bit 1 of gain control
HPLGAIN	12	I	Place R_F between pins 12 and 13
HPRGAIN	15	I	Place R_F between pins 14 and 15
HPLIN	3	I	Left HP single-ended (SE) input
HPOUT	13	O	Left headphone output
HPRIN	30	I	Right HP SE input
HPROUT	16	O	Right headphone output
LINN	1	I	Left class-D negative differential input
LINP	2	I	Left class-D positive differential input
LOUTP	7	O	Left positive bridge-tied load (BTL) output
LOUTN	10	O	Left negative BTL output
MODE	14	I	Mode = 1, then HP, Mode = 0, then BTL
NC	21	—	No connection
PGNDL	8, 9	I	Left class-D high-current ground
PGNDR	24, 25	I	Right class-D high-current ground
PVDDL	6, 11	I	Left class-D high-current power supply
PVDDR	22, 27	I	Right class-D high power supply
ROSC	18	I	Connect resistor to ground to set oscillation frequency
RINP	31	I	Right class-D positive differential signal
RINN	32	I	Right class-D negative differential signal
ROUTN	23	O	Right negative BTL output
ROUTP	26	O	Right positive BTL output
SHUTDOWN	28	I	Shutdown terminal (negative logic)
VDD	20	I	Power supply

absolute maximum ratings over operating free-air temperature (unless otherwise noted)†

Supply voltage, V_{DD} , $PV_{DDL,R}$	–0.3 V to 5.5 V
Input voltage, V_I	–0.3 V to $V_{DD}+0.3$ V
Continuous total power dissipation	See Dissipation Rating Table
Operating free-air temperature range, T_A	–40°C to 85°C
Operating junction temperature range, T_J	–40°C to 150°C
Storage temperature range, T_{stg}	–65°C to 150°C
Lead temperature 1,6 mm (1/16 inch) from case for 10 seconds	260°C

† Stresses beyond those listed under “absolute maximum ratings” may cause permanent damage to the device. These are stress ratings only, and functional operation of the device at these or any other conditions beyond those indicated under “recommended operating conditions” is not implied. Exposure to absolute-maximum-rated conditions for extended periods may affect device reliability.



TPA2000D4
STEREO 2-W CLASS-D AUDIO POWER AMPLIFIER
WITH STEREO HP AMPLIFIER

SLOS337A – DECEMBER 2000 – REVISED MAY 2003

DISSIPATION RATING TABLE

PACKAGE	$T_A \leq 25^\circ\text{C}$ POWER RATING	DERATING FACTOR ABOVE $T_A = 25^\circ\text{C}$	$T_A = 70^\circ\text{C}$ POWER RATING	$T_A = 85^\circ\text{C}$ POWER RATING
DAP	5.3 W	42.5 mW/°C	3.4 W	2.8 W

recommended operating conditions

	MIN	NOM	MAX	UNIT
Supply voltage, V_{DD} , PV_{DD} , V_{CC}	3.7		5.5	V
High-level input voltage, V_{IH}	2			V
Low-level input voltage, V_{IL}			0.8	V
Oscillator resistance, R_{OSC}		120		k Ω
Oscillator capacitance, C_{OSC}		220		pF
PWM Frequency	200		300	kHz
Operating free-air temperature, T_A	-40		85	°C

electrical characteristics over recommended operating free-air temperature range, $T_A = 25^\circ\text{C}$, $V_{DD} = PV_{DD} = 5\text{ V}$ (unless otherwise noted)

PARAMETER		TEST CONDITIONS	MIN	TYP	MAX	UNIT
$ V_{OS} $	Output offset voltage (measured differentially)	$V_I = 0\text{ V}$, $A_V = -2\text{ V/V}$			15	mV
PSRR	Power supply rejection ratio	$PV_{DD} = 4.5\text{ V to }5.5\text{ V}$ Class-D		-70		dB
		$PV_{DD} = 4.5\text{ V to }5.5\text{ V}$ Headphone		-75		
$ I_{IH} $	High-level input current	$PV_{DD} = 5.5\text{ V}$, $V_I = PV_{DD}$			1	μA
$ I_{IL} $	Low-level input current	$PV_{DD} = 5.5\text{ V}$, $V_I = 0\text{ V}$			1	μA
I_{DD}	Supply current	Class D	MODE = 0 V	9	12	mA
		Headphone	MODE = 5 V	7	11	
		Shutdown mode		0.05	1	
$I_{DD(SD)}$						μA

operating characteristics, class-D amplifier, $T_A = 25^\circ\text{C}$, $V_{DD} = PV_{DD} = 5\text{ V}$, $R_L = 4\ \Omega$, Gain = all gains (unless otherwise noted)

PARAMETER		TEST CONDITIONS	MIN	TYP	MAX	UNIT
P_O	Output power	THD = 0.1%, $f = 1\text{ kHz}$		2		W
THD+N	Total harmonic distortion plus noise	$P_O = 1\text{ W}$, $f = 20\text{ Hz to }20\text{ kHz}$		< 0.4%		
B _{OM}	Maximum output power bandwidth	THD = 1%		20		kHz
k _{SVR}	Supply ripple rejection ratio	$f = 1\text{ kHz}$, $C_{BYPASS} = 1\ \mu\text{F}$		-71		dB
SNR	Signal-to-noise ratio			85		dB
V_n	Noise output voltage	$C_{BYPASS} = 1\ \mu\text{F}$, $f = 20\text{ Hz to }20\text{ kHz}$		20		μV_{RMS}
Z_I	Input impedance			>15		k Ω



TPA2000D4
STEREO 2-W CLASS-D AUDIO POWER AMPLIFIER
WITH STEREO HP AMPLIFIER

SLOS337A – DECEMBER 2000 – REVISED MAY 2003

operating characteristics, class-D amplifier, $T_A = 25^\circ\text{C}$, $V_{DD} = PV_{DD} = 5\text{ V}$, $R_L = 8\ \Omega$, Gain = all gains (unless otherwise noted)

PARAMETER		TEST CONDITIONS	MIN	TYP	MAX	UNIT
P_O	Output power	THD = 0.1%, $f = 1\text{ kHz}$		1.5		W
THD+N	Total harmonic distortion plus noise	$P_O = 0.5\text{ W}$, $f = 20\text{ Hz to }20\text{ kHz}$		<0.2%		
B_{OM}	Maximum output power bandwidth	THD = 1%		20		kHz
k_{SVR}	Supply ripple rejection ratio	$f = 1\text{ kHz}$, $C_{BYPASS} = 1\ \mu\text{F}$		-71		dB
SNR	Signal-to-noise ratio			85		dB
V_n	Noise output voltage	$C_{BYPASS} = 1\ \mu\text{F}$, $f = 20\text{ Hz to }20\text{ kHz}$		20		μV_{RMS}
Z_I	Input impedance			>15		$\text{k}\Omega$

operating characteristics, headphone amplifier, $T_A = 25^\circ\text{C}$, $V_{DD} = PV_{DD} = 5\text{ V}$, $R_L = 32\ \Omega$, Gain = 1 V/V (unless otherwise noted)

PARAMETER		TEST CONDITIONS	MIN	TYP	MAX	UNIT
P_O	Output power	THD = 0.1%, $f = 1\text{ kHz}$		90		mW
THD+N	Total harmonic distortion plus noise	$P_O = 75\text{ mW}$, $f = 20\text{ Hz to }20\text{ kHz}$		<0.2%		
B_{OM}	Maximum output power bandwidth	THD = 1%		20		kHz
k_{SVR}	Supply ripple rejection ratio	$f = 1\text{ kHz}$, $C_{BYPASS} = 1\ \mu\text{F}$		-42		dB
SNR	Signal-to-noise ratio			80		dB
V_n	Noise output voltage	$C_{BYPASS} = 1\ \mu\text{F}$, $f = 20\text{ Hz to }20\text{ kHz}$		20		μV_{RMS}

Table 1. Gain Settings

GAIN1	GAIN0	AMPLIFIER GAIN (dB)	INPUT IMPEDANCE ($\text{k}\Omega$)
		TYP	TYP
0	0	6	104
0	1	12	74
1	0	18	44
1	1	23.5	24

TPA2000D4
STEREO 2-W CLASS-D AUDIO POWER AMPLIFIER
WITH STEREO HP AMPLIFIER

SLOS337A – DECEMBER 2000 – REVISED MAY 2003

TYPICAL CHARACTERISTICS

Table of Graphs

		FIGURE
Efficiency	vs Output power	2, 3
FFT at 1.5-W Output Power	vs Frequency	4
Supply current	vs Free-air temperature	5
Total harmonic distortion + noise	vs Frequency	6, 7
Total harmonic distortion + noise	vs Output power	8, 9
Class-D gain and phase	vs Frequency	10
Class-D crosstalk	vs Frequency	11
Power dissipation	vs Output power	12
FFT at 1.5-W output power	vs Frequency	13
Supply voltage rejection ratio	vs Frequency	14
Headphone total harmonic distortion + noise	vs Frequency	15, 16, 22
Headphone total harmonic distortion + noise	vs Output power	17
Headphone closed-loop gain and phase	vs Frequency	18
Headphone open-loop gain and phase	vs Frequency	19
Headphone crosstalk	vs Frequency	20, 24
Headphone supply voltage rejection ratio	vs Frequency	21
Headphone total harmonic distortion + noise	vs Output voltage	23
Headphone supply current	vs Output voltage	25
Headphone supply current	vs Output power	26

test set-up for graphs

The THD+N measurements shown do not use an LC output filter, but use a low pass filter with a cut-off frequency of 20 kHz so the switching frequency does not dominate the measurement. This is done to ensure that the THD+N measured is just the audible THD+N. The THD+N measurements are shown at the highest gain for worst case.

The LC output filter used in the efficiency curves (Figure 2 and Figure 3) is shown in Figure 1.

- L1 = L2 = 22 μ H (DCR = 110 m Ω ,
- Part Number = SCD0703T-220 M-S,
- Manufacturer = GCI)
- C1 = C2 = 1 μ F

The ferrite filter used in the efficiency curves (Figure 2 and Figure 3) is shown in Figure 1, where L is a ferrite bead.

- L1 = L2 = ferrite bead (part number = 2512067007Y3, manufacturer = Fair-Rite) C1 = C2 = 1 nF

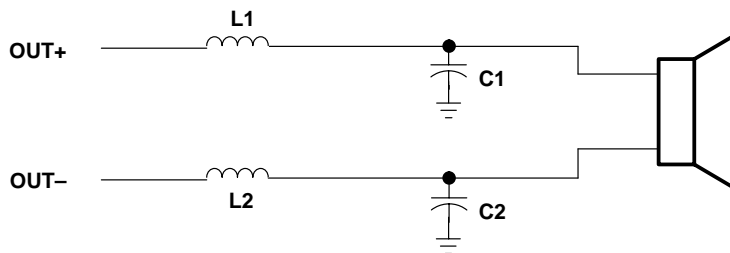

Figure 1. Class-D Output Filter

TYPICAL CHARACTERISTICS

**EFFICIENCY
 vs
 OUTPUT POWER**

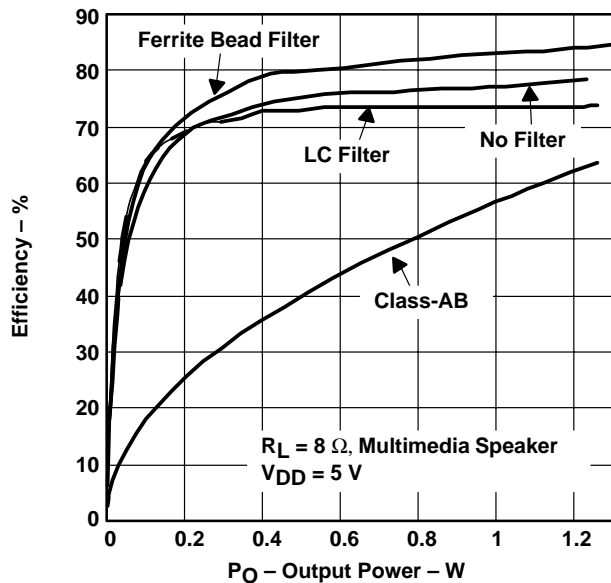

Figure 2

**EFFICIENCY
 vs
 OUTPUT POWER**

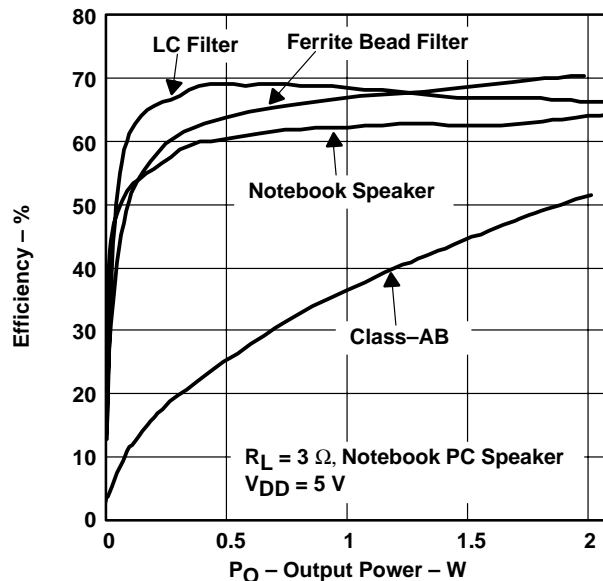

Figure 3

**FFT AT 1.5-W OUTPUT POWER
 vs
 FREQUENCY**

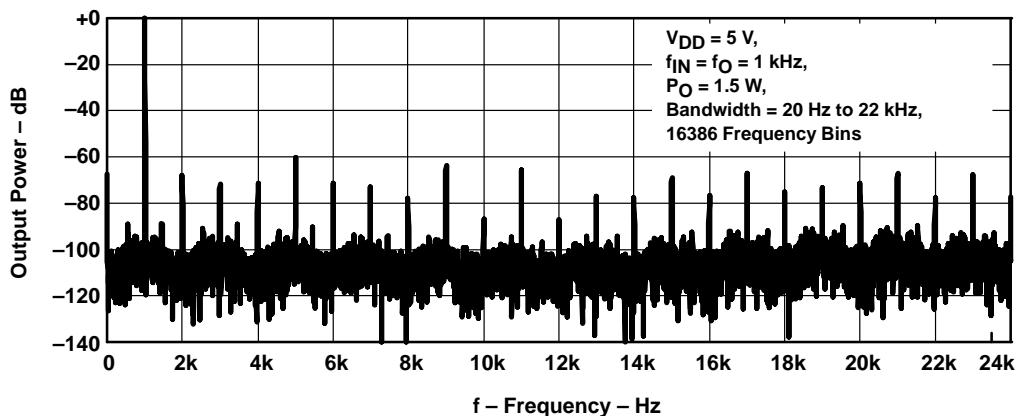

Figure 4

TPA2000D4
STEREO 2-W CLASS-D AUDIO POWER AMPLIFIER
WITH STEREO HP AMPLIFIER

SLOS337A – DECEMBER 2000 – REVISED MAY 2003

TYPICAL CHARACTERISTICS

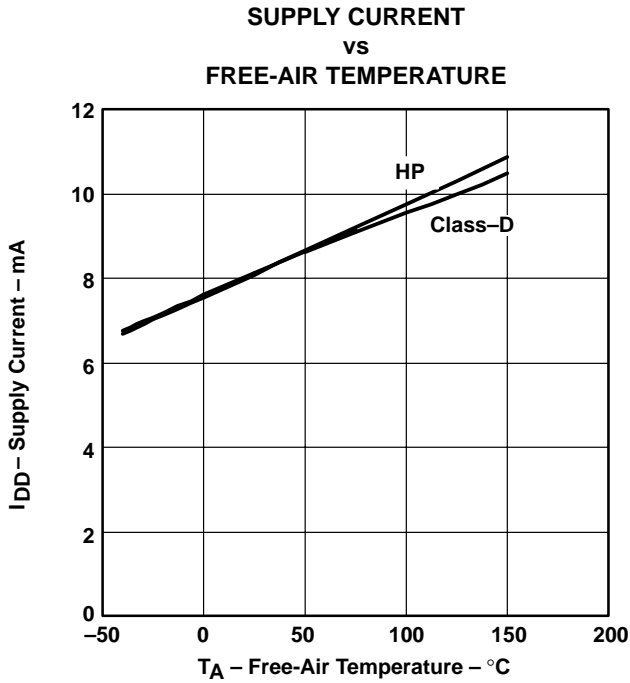

Figure 5

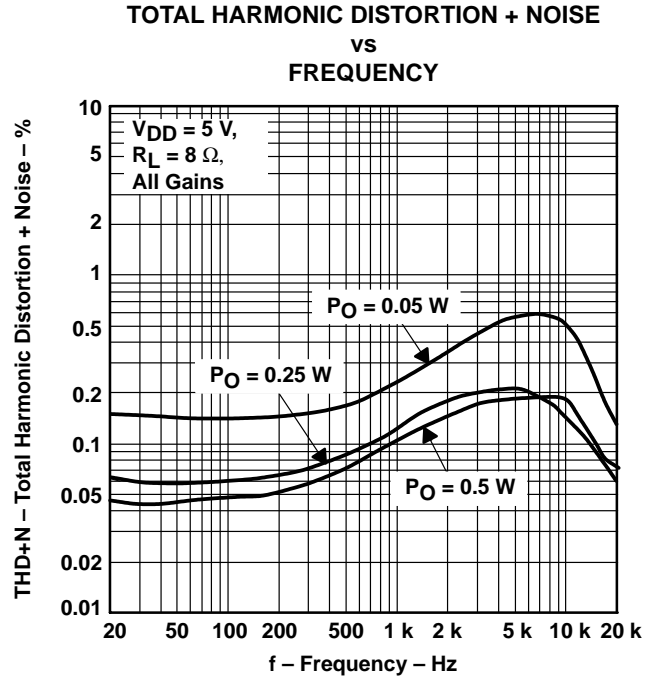

Figure 6

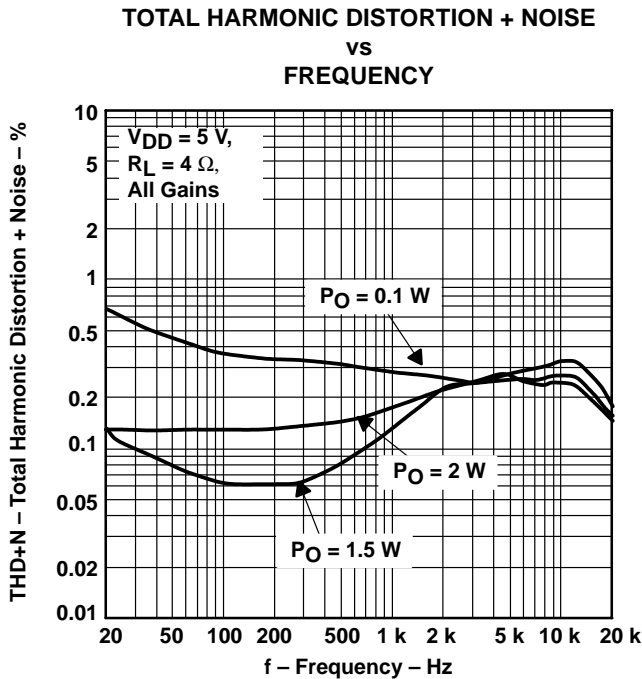

Figure 7

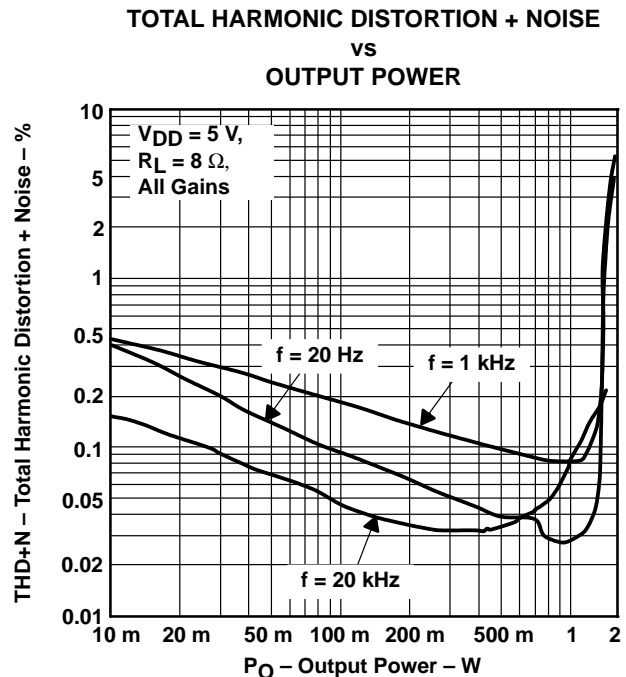

Figure 8



TYPICAL CHARACTERISTICS

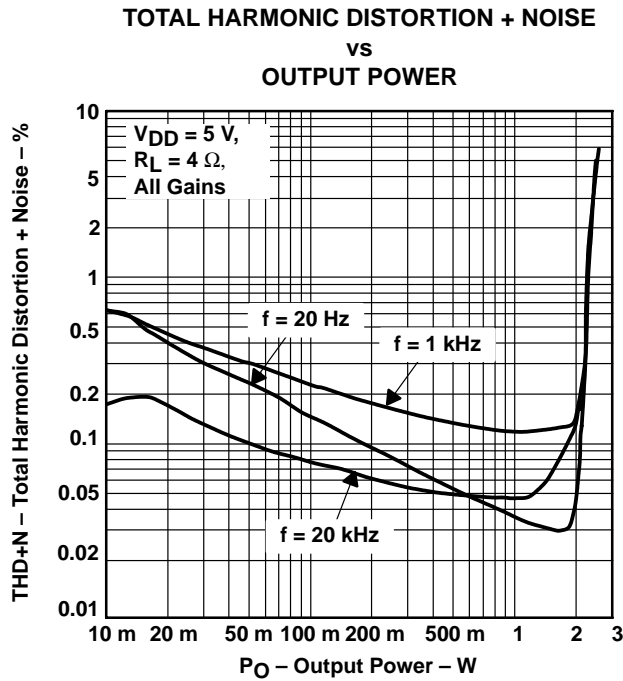

Figure 9

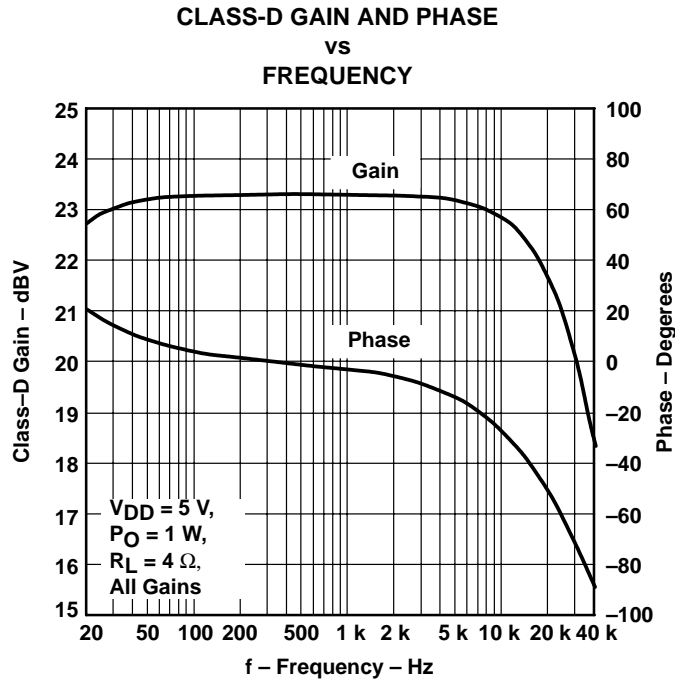

Figure 10

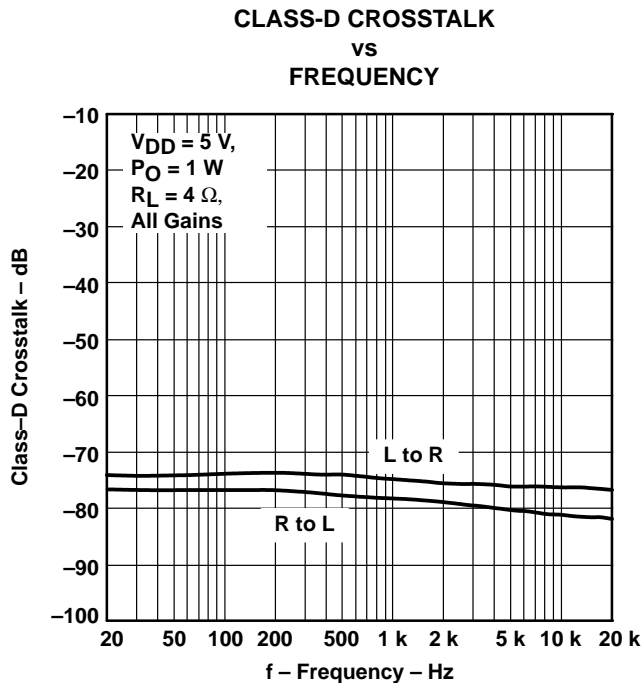

Figure 11

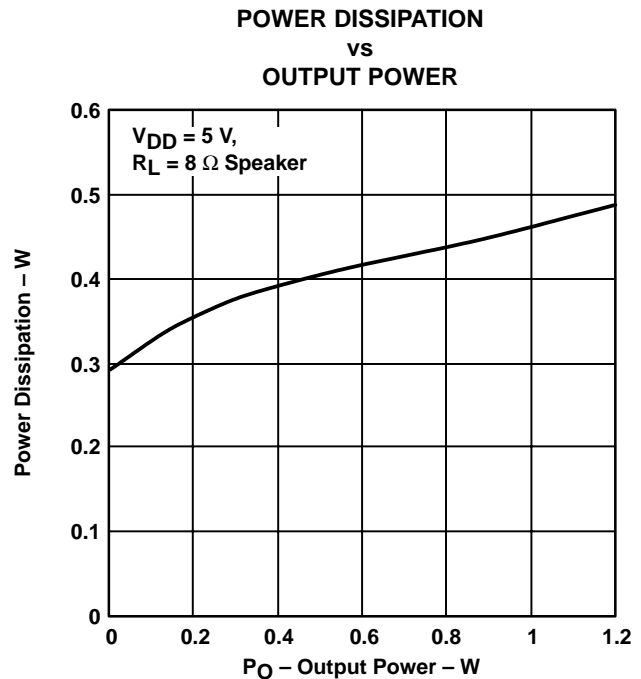

Figure 12

TPA2000D4
STEREO 2-W CLASS-D AUDIO POWER AMPLIFIER
WITH STEREO HP AMPLIFIER

SLOS337A – DECEMBER 2000 – REVISED MAY 2003

TYPICAL CHARACTERISTICS

FFT AT 1.5-W OUTPUT POWER
VS
FREQUENCY

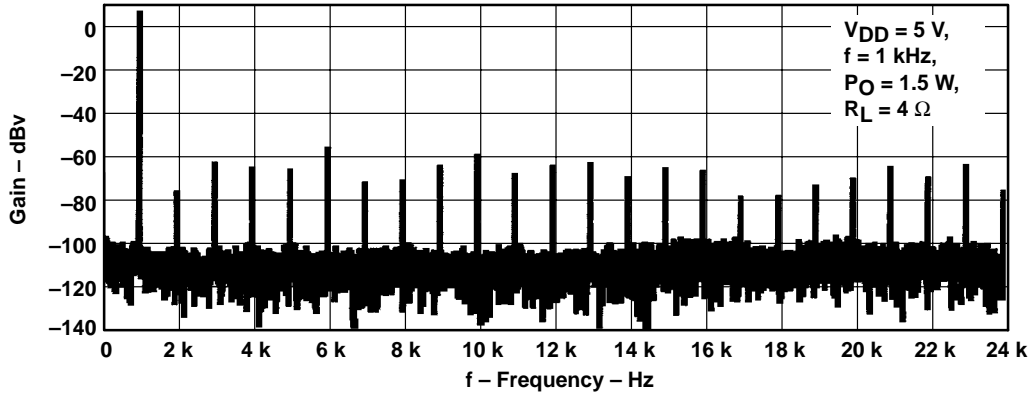

Figure 13

SUPPLY VOLTAGE REJECTION RATIO
VS
FREQUENCY

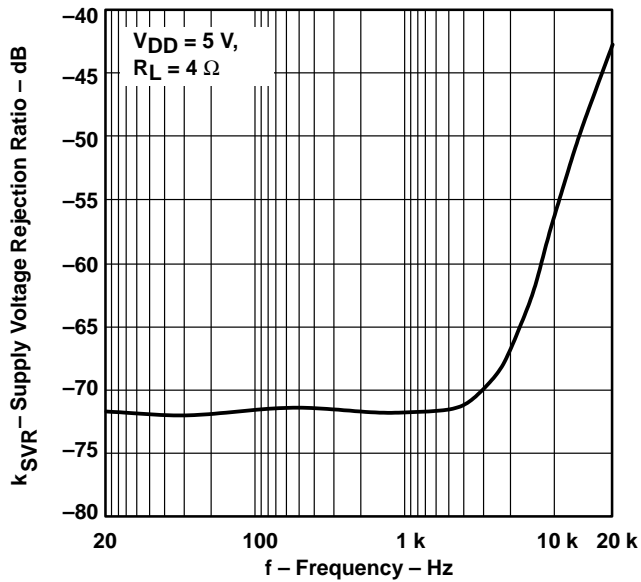

Figure 14

HEADPHONE
TOTAL HARMONIC DISTORTION + NOISE
VS
FREQUENCY

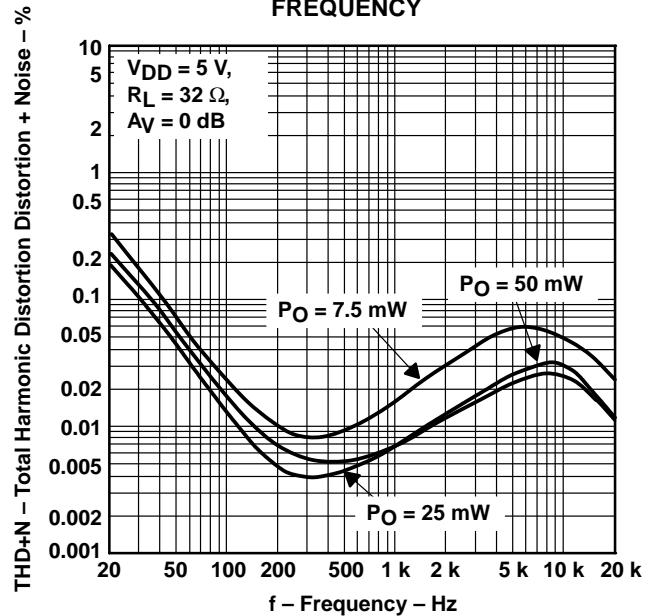

Figure 15



TYPICAL CHARACTERISTICS

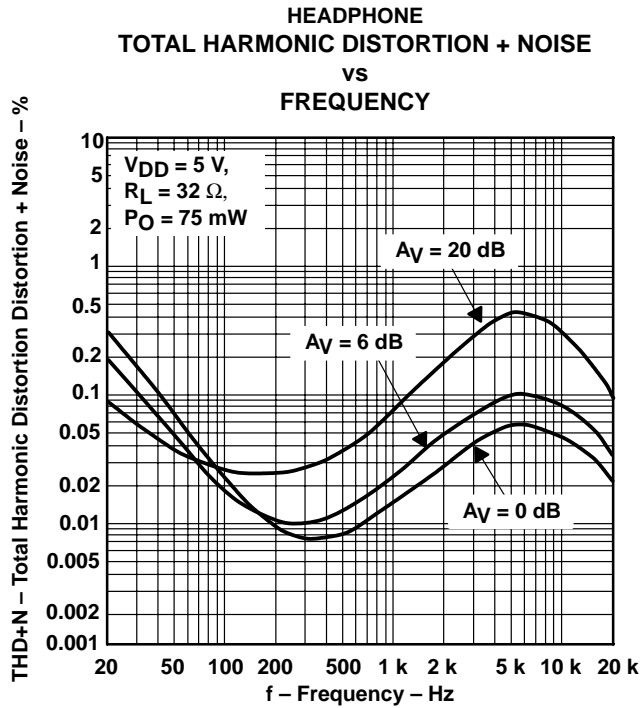

Figure 16

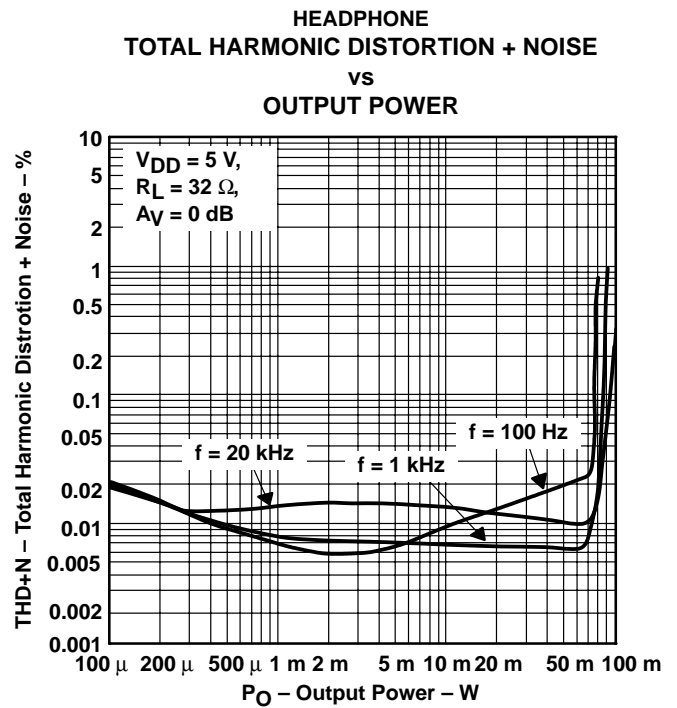

Figure 17

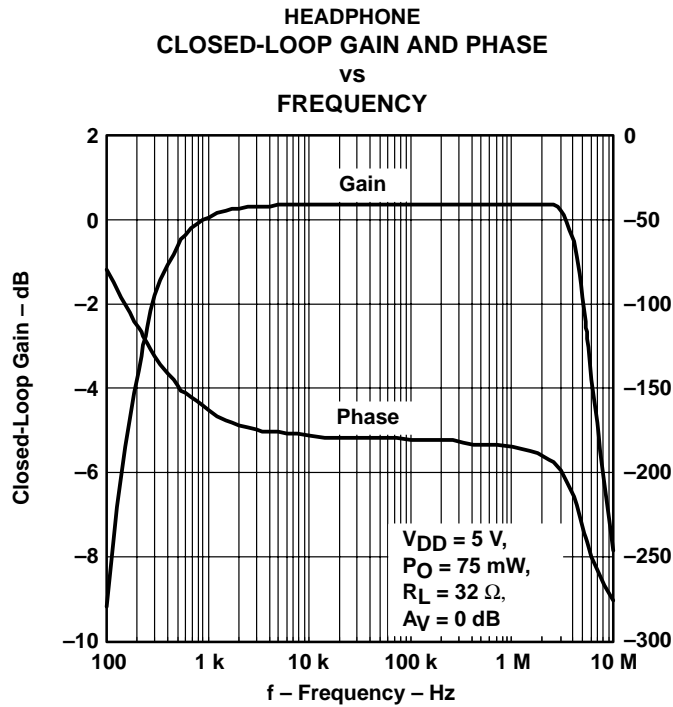
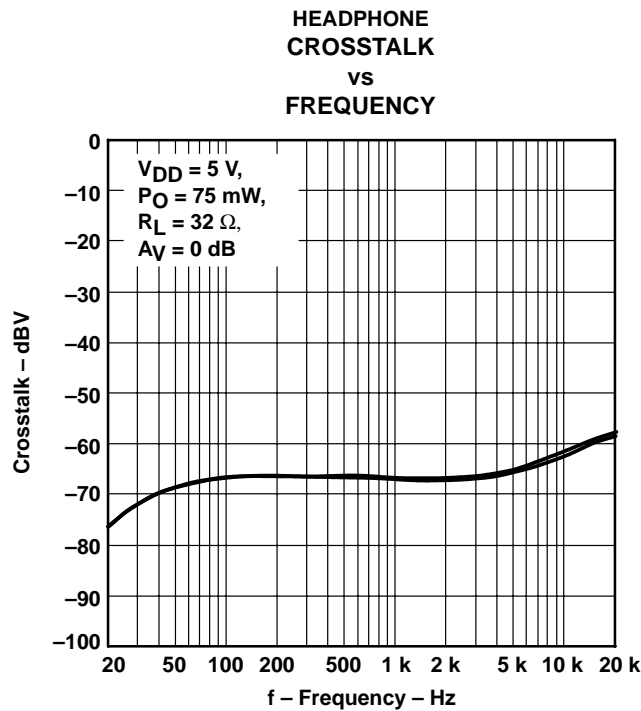
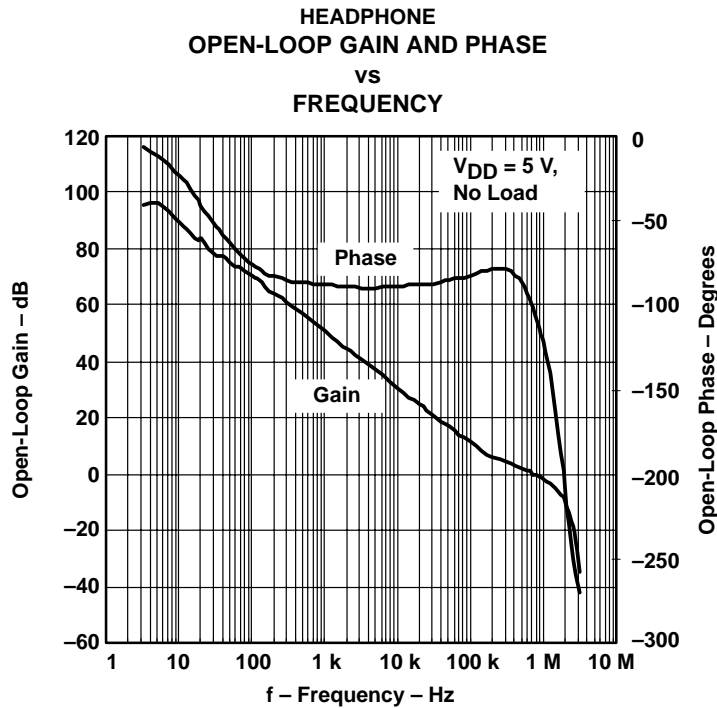

Figure 18

TPA2000D4
STEREO 2-W CLASS-D AUDIO POWER AMPLIFIER
WITH STEREO HP AMPLIFIER

SLOS337A – DECEMBER 2000 – REVISED MAY 2003

TYPICAL CHARACTERISTICS



TYPICAL CHARACTERISTICS

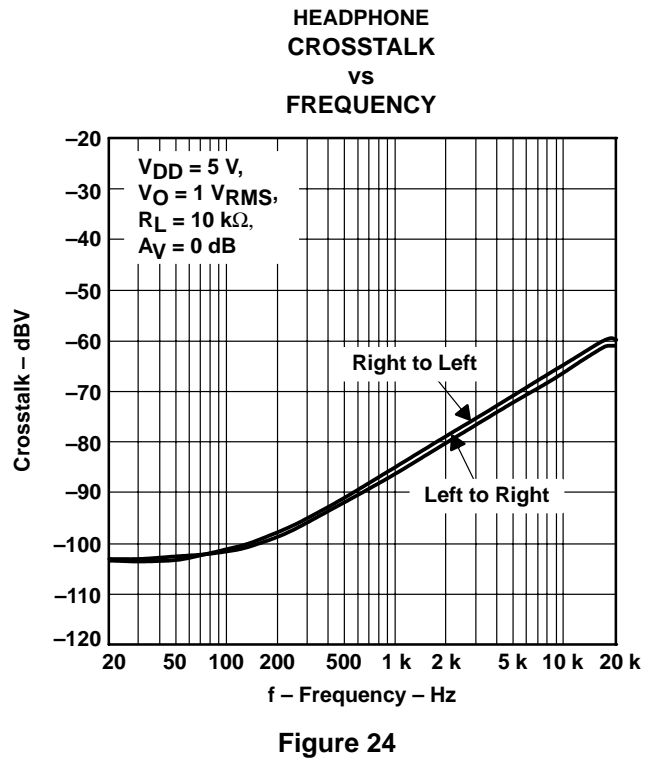
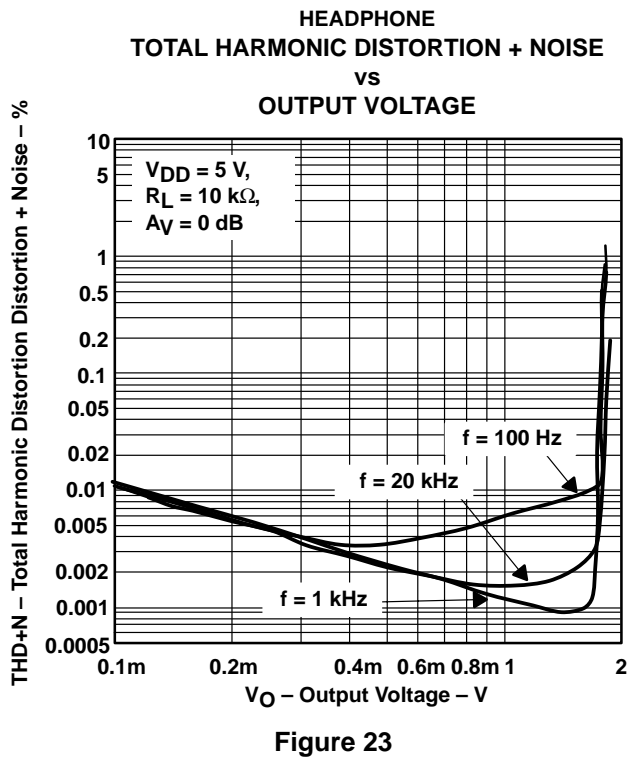
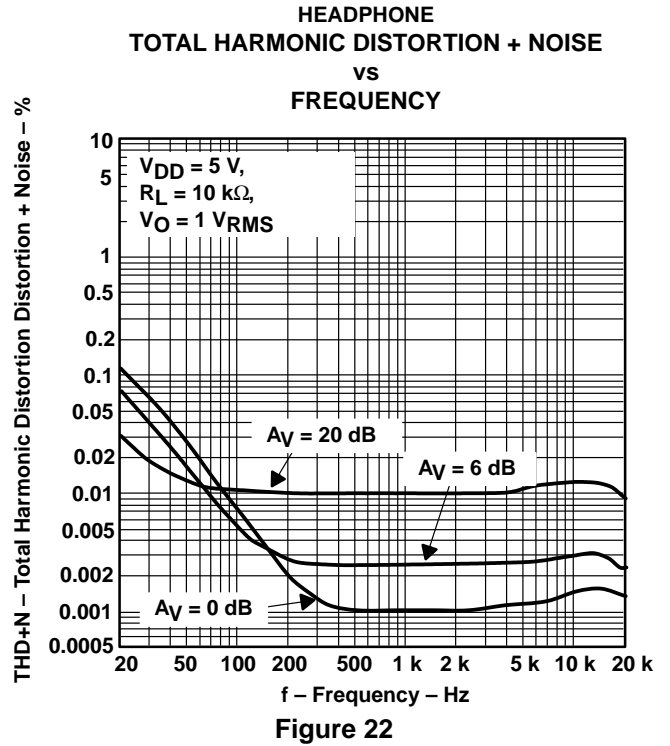
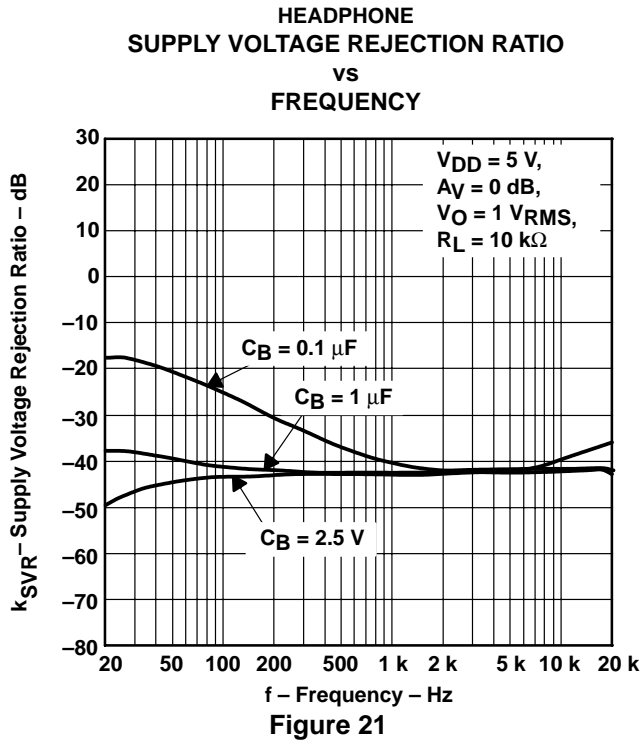

TPA2000D4
STEREO 2-W CLASS-D AUDIO POWER AMPLIFIER
WITH STEREO HP AMPLIFIER

SLOS337A – DECEMBER 2000 – REVISED MAY 2003

TYPICAL CHARACTERISTICS

**HEADPHONE
 SUPPLY CURRENT
 vs
 OUTPUT VOLTAGE**

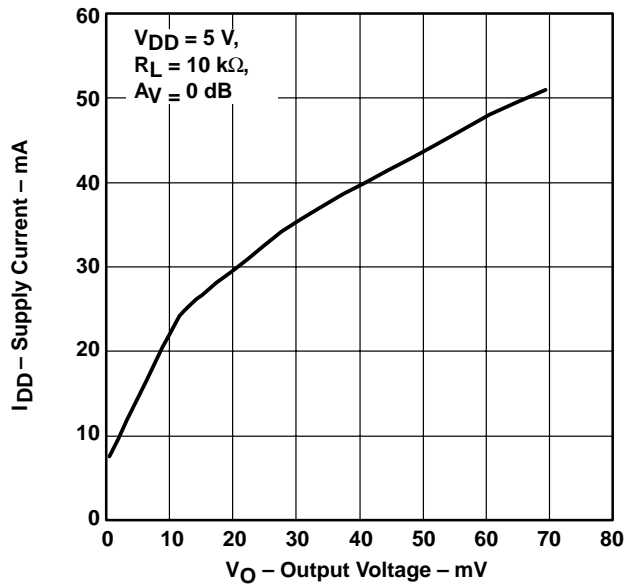

Figure 25

**HEADPHONE
 SUPPLY CURRENT
 vs
 OUTPUT POWER**

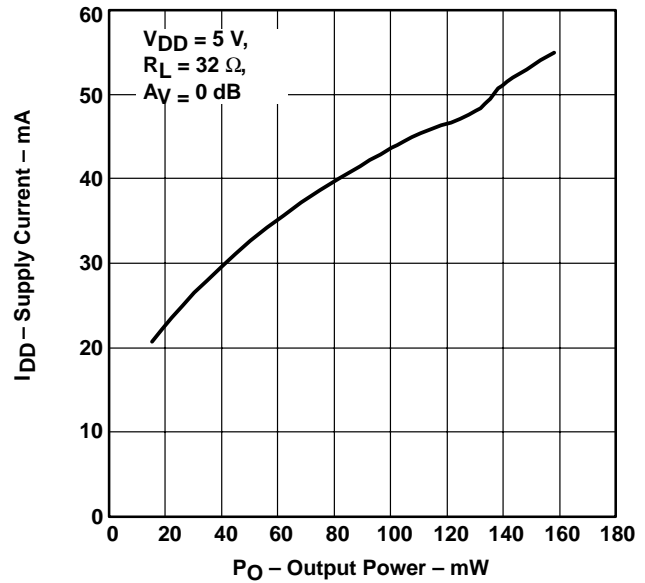

Figure 26

APPLICATION INFORMATION

eliminating the output filter with the TPA2000D4

This section will focus on why the user can eliminate the output filter with the TPA2000D4.

effect on audio

The class-D amplifier outputs a pulse-width modulated (PWM) square wave, which is the sum of the switching waveform and the amplified input audio signal. The human ear acts as a band-pass filter such that only the frequencies between approximately 20 Hz and 20 kHz are passed. The switching frequency components are much greater than 20 kHz, so the only signal heard is the amplified input audio signal.

traditional class-D modulation scheme

The traditional class-D modulation scheme, which is used in the TPA005Dxx family, has a differential output where each output is 180 degrees out of phase and changes from ground to the supply voltage, V_{DD} . Therefore, the differential prefiltered output varies between positive and negative V_{DD} , where filtered 50% duty cycle yields 0 V across the load. The traditional class-D modulation scheme with voltage and current waveforms is shown in Figure 27. Note that even at an average of 0 V across the load (50% duty cycle), the current to the load is high thus, causing a high supply current.

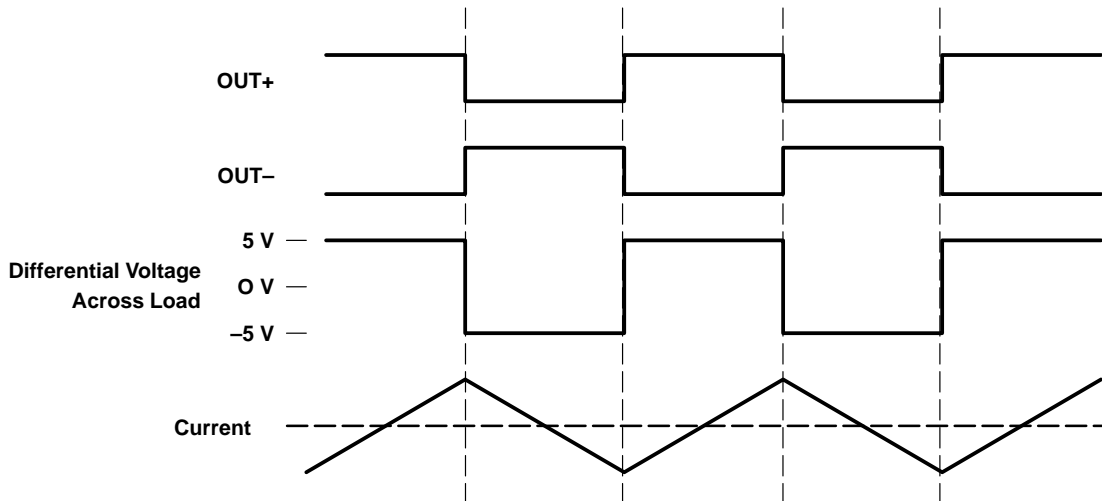

Figure 27. Traditional Class-D Modulation Scheme's Output Voltage and Current Waveforms Into an Inductive Load With No Input

TPA2000D4 modulation scheme

The TPA2000D4 uses a modulation scheme that still has each output switching from 0 to the supply voltage. However, OUT+ and OUT- are now in phase with each other with no input. The duty cycle of OUT+ is greater than 50% and OUT- is less than 50% for positive voltages. The duty cycle of OUT+ is less than 50% and OUT- is greater than 50% for negative voltages. The voltage across the load sits at 0 V throughout most of the switching period greatly reducing the switching current, which reduces any I^2R losses in the load.

TPA2000D4
STEREO 2-W CLASS-D AUDIO POWER AMPLIFIER
WITH STEREO HP AMPLIFIER

SLOS337A – DECEMBER 2000 – REVISED MAY 2003

APPLICATION INFORMATION

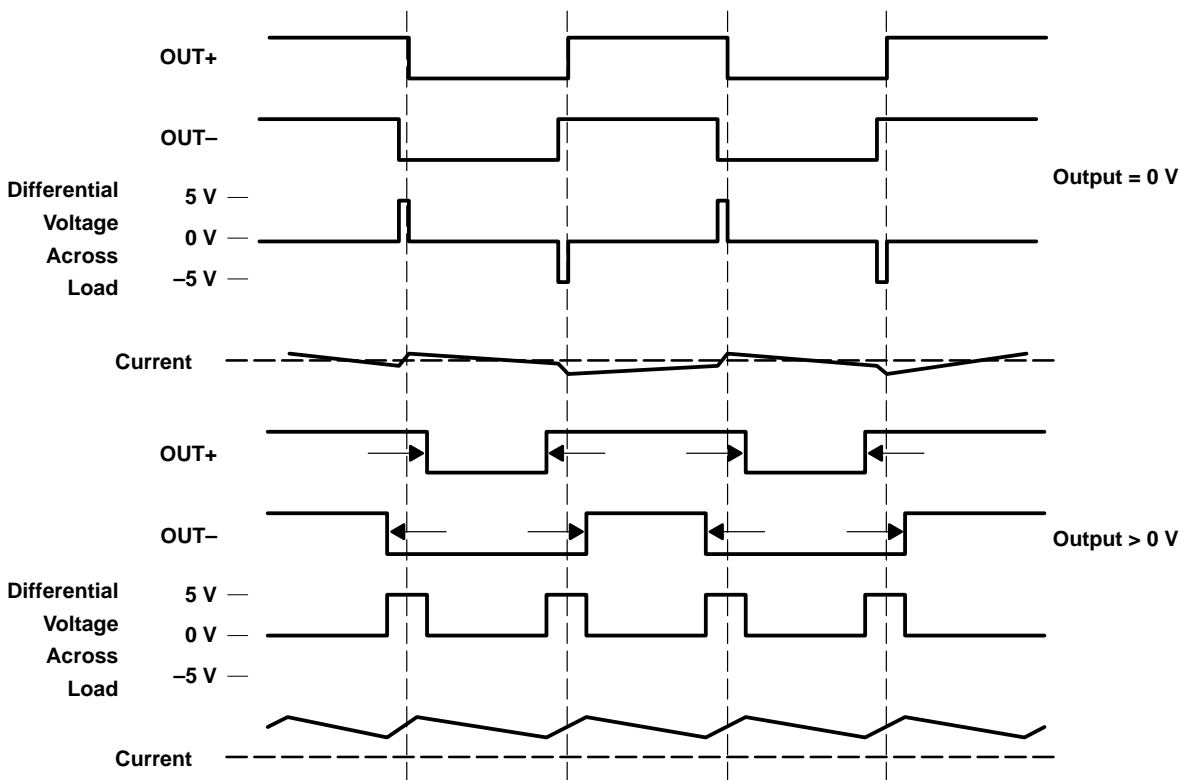

Figure 28. The TPA2000D4 Output Voltage and Current Waveforms Into an Inductive Load

efficiency: why you must use a filter with the traditional class-D modulation scheme

The main reason that the traditional class-D amplifier needs an output filter is that the switching waveform results in maximum current flow. This causes more loss in the load, which causes lower efficiency. The ripple current is large for the traditional modulation scheme because the ripple current is proportional to voltage multiplied by the time at that voltage. The differential voltage swing is $2 \times V_{DD}$ and the time at each voltage is half the period for the traditional modulation scheme. An ideal LC filter is needed to store the ripple current from each half cycle for the next half cycle, while any resistance causes power dissipation. The speaker is both resistive and reactive, whereas an LC filter is almost purely reactive.

The TPA2000D4 modulation scheme has very little loss in the load without a filter because the pulses are very short and the change in voltage is V_{DD} instead of $2 \times V_{DD}$. As the output power increases, the pulses widen, making the ripple current larger. Ripple current could be filtered with an LC filter for increased efficiency, but for most applications the filter is not needed.

An LC filter with a cutoff frequency less than the class-D switching frequency allows the switching current to flow through the filter instead of the load. The filter has less resistance than the speaker that results in less power dissipated, which increases efficiency.



APPLICATION INFORMATION

effects of applying a square wave into a speaker

Audio specialists have said for years not to apply a square wave to speakers. If the amplitude of the waveform is high enough and the frequency of the square wave is within the bandwidth of the speaker, the square wave could cause the voice coil to jump out of the air gap and/or scar the voice coil. A 250-kHz switching frequency, however, is not significant because the speaker cone movement is proportional to $1/f^2$ for frequencies beyond the audio band. Therefore, the amount of cone movement at the switching frequency is very small. However, damage could occur to the speaker if the voice coil is not designed to handle the additional power. To size the speaker for added power, the ripple current dissipated in the load needs to be calculated by subtracting the theoretical supplied power, $P_{SUP\ THEORETICAL}$, from the actual supply power, P_{SUP} , at maximum output power, P_{OUT} . The switching power dissipated in the speaker is the inverse of the measured efficiency, $\eta_{MEASURED}$, minus the theoretical efficiency, $\eta_{THEORETICAL}$.

$$P_{SPKR} = P_{SUP} - P_{SUP\ THEORETICAL} \text{ (at max output power)} \quad (1)$$

$$P_{SPKR} = P_{SUP} / P_{OUT} - P_{SUP\ THEORETICAL} / P_{OUT} \text{ (at max output power)} \quad (2)$$

$$P_{SPKR} = 1/\eta_{MEASURED} - 1/\eta_{THEORETICAL} \text{ (at max output power)} \quad (3)$$

The maximum efficiency of the TPA2000D4 with an 8- Ω load is 85%. Using equation 3 with the efficiency at maximum power from Figure 2 (78%), we see that there is an additional 106 mW dissipated in the speaker. The added power dissipated in the speaker is not an issue as long as it is taken into account when choosing the speaker.

when to use an output filter

Design the TPA2000D4 without the filter if the traces from amplifier to speaker are short. The TPA2000D4 passed FCC and CE radiated emissions with no shielding with speaker wires 8 inches long or less. Notebook PCs and powered speakers where the speaker is in the same enclosure as the amplifier are good applications for class-D without a filter.

A ferrite bead filter can often be used if the design is failing radiated emissions without a filter, and the frequency sensitive circuit is greater than 1 MHz. This is good for circuits that just have to pass FCC and CE because FCC and CE only test radiated emissions greater than 30 MHz. If choosing a ferrite bead, choose one with high impedance at high frequencies, but very low impedance at low frequencies.

Use an output filter if there are low frequency (< 1 MHz) EMI sensitive circuits and/or there are long leads from amplifier to speaker.

gain setting via GAIN0 and GAIN1 inputs

The gain of the TPA2000D4 is set by two input terminals, GAIN0 and GAIN1.

The gains listed in Table 1 are realized by changing the taps on the input resistors inside the amplifier. This causes the input impedance, Z_i , to be dependent on the gain setting. The actual gain settings are controlled by ratios of resistors, so the actual gain distribution from part-to-part is quite good. However, the input impedance may shift by 30% due to shifts in the actual resistance of the input resistors.

For design purposes, the input network (discussed in the next section) should be designed assuming an input impedance of 20 k Ω , which is the absolute minimum input impedance of the TPA2000D4. At the higher gain settings, the input impedance could increase as high as 115 k Ω .

TPA2000D4
STEREO 2-W CLASS-D AUDIO POWER AMPLIFIER
WITH STEREO HP AMPLIFIER

SLOS337A – DECEMBER 2000 – REVISED MAY 2003

APPLICATION INFORMATION

Table 2. Gain Settings

GAIN1	GAIN0	AMPLIFIER GAIN (dB)	INPUT IMPEDANC (kΩ)
		TYP	TYP
0	0	6	104
0	1	12	74
1	0	18	44
1	1	23.5	24

input resistance

Each gain setting is achieved by varying the input resistance of the amplifier, which can range from its smallest value to over 6 times that value.

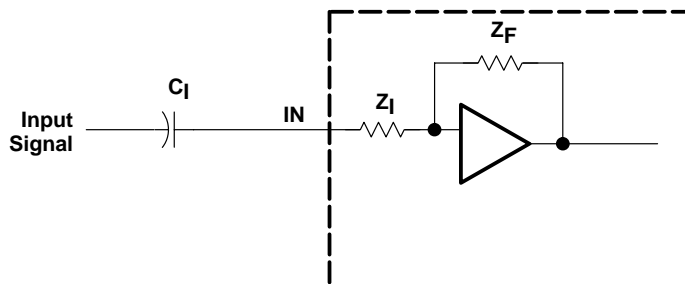

The -3 dB frequency can be calculated using equation 4:

$$f_{-3 \text{ dB}} = \frac{1}{2\pi C_1 Z_1} \tag{4}$$

APPLICATION INFORMATION

input capacitor, C_I

In the typical application an input capacitor, C_I , is required to allow the amplifier to bias the input signal to the proper dc level for optimum operation. In this case, C_I and the input impedance of the amplifier, Z_I , form a high-pass filter with the corner frequency determined in equation 5.

$$f_{c(\text{highpass})} = \frac{1}{2\pi Z_I C_I} \quad (5)$$

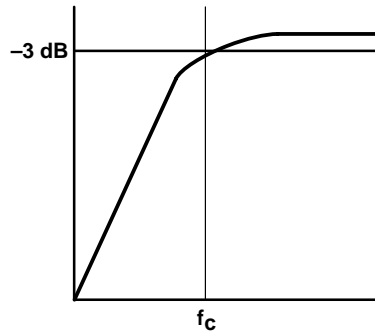

The value of C_I is important as it directly affects the bass (low frequency) performance of the circuit. Consider the example where Z_I is 20 k Ω and the specification calls for a flat bass response down to 80 Hz. Equation 5 is reconfigured as equation 6.

$$C_I = \frac{1}{2\pi Z_I f_c} \quad (6)$$

In this example, C_I is 0.1 μF , so one would likely choose a value in the range of 0.1 μF to 1 μF . If the gain is known and is constant, use Z_I from Table 1 to calculate C_I . A further consideration for this capacitor is the leakage path from the input source through the input network (C_I) and the feedback network to the load. This leakage current creates a dc offset voltage at the input to the amplifier that reduces useful headroom, especially in high gain applications. For this reason a low-leakage tantalum or ceramic capacitor is the best choice. When polarized capacitors are used, the positive side of the capacitor should face the amplifier input in most applications as the dc level there is held at $V_{DD}/2$, which is likely higher than the source dc level. Note that it is important to confirm the capacitor polarity in the application.

C_I must be 10 times smaller than the bypass capacitor to reduce clicking and popping noise from power on/off and entering and leaving shutdown. After sizing C_I for a given cutoff frequency, size the bypass capacitor to 10 times that of the input capacitor.

$$C_I \leq C_{BYP} / 10 \quad (7)$$

switching frequency

The switching frequency is determined using the values of the components connected to R_{OSC} (pin 18) and C_{OSC} (pin 19) and is calculated with the following equation:

$$f_s = \frac{6.6}{R_{OSC} C_{OSC}} \quad (8)$$

The switching frequency was chosen to be centered on 250 kHz. This frequency represents the optimization of audio fidelity due to oversampling and the maximization of efficiency by minimizing the switching losses of the amplifier. The recommended values are a resistance of 120 k Ω and a capacitance of 220 pF. Using these component values, the amplifier operates properly by using 5% tolerance resistors and 10% tolerance capacitors. The tolerance of the components can be changed, as long as the switching frequency remains between 200 kHz and 300 kHz. Within this range, the internal circuitry of the device provides stable operation.

TPA2000D4 STEREO 2-W CLASS-D AUDIO POWER AMPLIFIER WITH STEREO HP AMPLIFIER

SLOS337A – DECEMBER 2000 – REVISED MAY 2003

APPLICATION INFORMATION

gain setting resistors, R_F and R_I for HP amplifier

The voltage gain for the TPA2000D4 headphone amplifier is set by resistors R_F and R_I according to equation 9.

$$\text{Gain} = - \left(\frac{R_F}{R_I} \right) \text{ or Gain (dB)} = 20 \log \left(\frac{R_F}{R_I} \right) \quad (9)$$

Given that the TPA2000D4 is a MOS amplifier, the input impedance is very high. Consequently input leakage currents are not generally a concern, although noise in the circuit increases as the value of R_F increases. In addition, a certain range of R_F values is required for proper start-up operation of the amplifier. Taken together it is recommended that the effective impedance seen by the inverting node of the amplifier be set between 5 k Ω and 20 k Ω . The effective impedance is calculated in equation 10.

$$\text{Effective Impedance} = \frac{R_F R_I}{R_F + R_I} \quad (10)$$

As an example, consider an input resistance of 20 k Ω and a feedback resistor of 20 k Ω . The gain of the amplifier would be -1 and the effective impedance at the inverting terminal would be 10 k Ω , which is within the recommended range.

For high performance applications, metal film resistors are recommended because they tend to have lower noise levels than carbon resistors. For values of R_F above 50 k Ω , the amplifier tends to become unstable due to a pole formed from R_F and the inherent input capacitance of the MOS input structure. For this reason, a small compensation capacitor of approximately 5 pF should be placed in parallel with R_F . This, in effect, creates a low-pass filter network with the cutoff frequency defined in equation 11.

$$f_c = \frac{1}{2\pi R_F C_F} \quad (11)$$

For example, if R_F is 100 k Ω and C_F is 5 pF then f_c is 318 kHz, which is well outside the audio range.

For maximum signal swing and output power at low supply voltages like 1.6 V to 3.3 V, BYPASS is biased to $V_{DD}/4$. However, to allow the output to be biased at $V_{DD}/2$, a resistor, R , equal to R_F must be placed from the negative input to ground.

input capacitor, C_I for HP amplifier

In the typical application, an input capacitor, C_I , is required to allow the amplifier to bias the input signal to the proper dc level for optimum operation. In this case, C_I and R_I form a high-pass filter with the corner frequency determined in equation 12.

$$f_c = \frac{1}{2\pi R_I C_I} \quad (12)$$

The value of C_I is important to consider, as it directly affects the bass (low frequency) performance of the circuit. Consider the example where R_I is 20 k Ω and the specification calls for a flat bass response down to 20 Hz. Equation 4 is reconfigured as equation 13.

$$C_I = \frac{1}{2\pi R_I f_c} \quad (13)$$

In this example, C_I is 0.40 μ F, so one would likely choose a value in the range of 0.47 μ F to 1 μ F. A further consideration for this capacitor is the leakage path from the input source through the input network (R_I , C_I) and the feedback resistor (R_F) to the load. This leakage current creates a dc offset voltage at the input to the amplifier that reduces useful headroom, especially in high-gain applications (>10). For this reason a low-leakage tantalum or ceramic capacitor is the best choice. When polarized capacitors are used, the positive side of the capacitor should face the amplifier input in most applications, as the dc level there is held at $V_{DD}/4$, which is likely higher than the source dc level. It is important to confirm the capacitor polarity in the application.

APPLICATION INFORMATION

output coupling capacitor, C_C for HP amplifier

In the typical single-supply single-ended (SE) configuration, an output coupling capacitor (C_C) is required to block the dc bias at the output of the amplifier, thus preventing dc currents in the load. As with the input coupling capacitor, the output coupling capacitor and impedance of the load form a high-pass filter governed by equation 14.

$$f_c = \frac{1}{2\pi R_L C_C} \quad (14)$$

The main disadvantage, from a performance standpoint, is that the typically small load impedances drive the low-frequency corner higher. Large values of C_C are required to pass low frequencies into the load. Consider the example where a C_C of 68 μF is chosen and loads vary from 32 Ω to 47 k Ω . Table 3 summarizes the frequency response characteristics of each configuration.

Table 3. Common Load Impedances vs Low Frequency Output Characteristics in SE Mode

R_L	C_C	Lowest Frequency
32 Ω	68 μF	73 Hz
10,000 Ω	68 μF	0.23 Hz
47,000 Ω	68 μF	0.05 Hz

As Table 3 indicates, headphone response is adequate and drive into line level inputs (a home stereo for example) is very good.

The output coupling capacitor required in single-supply SE mode also places additional constraints on the selection of other components in the amplifier circuit. With the rules described earlier still valid, add the following relationship:

$$\frac{1}{(C_B \times 55 \text{ k}\Omega)} \leq \frac{1}{(C_I R_I)} \ll \frac{1}{R_L C_C} \quad (15)$$

power supply decoupling, C_S

The TPA2000D4 is a high-performance CMOS audio amplifier that requires adequate power supply decoupling to ensure the output total harmonic distortion (THD) is as low as possible. Power supply decoupling also prevents oscillations for long lead lengths between the amplifier and the speaker. The optimum decoupling is achieved by using two capacitors of different types that target different types of noise on the power supply leads. For higher frequency transients, spikes, or digital hash on the line, a good low equivalent-series-resistance (ESR) ceramic capacitor, typically 0.1 μF , placed as close as possible to the device V_{DD} lead works best. For filtering lower-frequency noise signals, a larger aluminum electrolytic capacitor of 10 μF or greater, placed near the audio power amplifier is recommended.

midrail bypass capacitor, C_{BYP}

The midrail bypass capacitor, C_{BYP} , is the most critical capacitor and serves several important functions. During start-up or recovery from shutdown mode, C_{BYP} determines the rate at which the amplifier starts up. The second function is to reduce noise produced by the power supply caused by coupling into the output drive signal. This noise is from the midrail generation circuit internal to the amplifier, which appears as degraded PSRR and THD+N.

Bypass capacitor (C_{BYP}) values of 0.47- μF to 1- μF ceramic or tantalum, low-ESR capacitors are recommended for the best THD and noise performance.

TPA2000D4 STEREO 2-W CLASS-D AUDIO POWER AMPLIFIER WITH STEREO HP AMPLIFIER

SLOS337A – DECEMBER 2000 – REVISED MAY 2003

APPLICATION INFORMATION

midrail bypass capacitor, C_{BYP} (continued)

Increasing the bypass capacitor reduces clicking and popping noise from power on/off and entering and leaving shutdown. To have minimal pop, C_{BYP} should be 10 times larger than C_I .

$$C_{BYP} \geq 10 \times C_I \quad (16)$$

differential input

The differential input stage of the amplifier cancels any noise that appears on both input lines of a channel. To use the TPA2000D4 EVM with a differential source, connect the positive lead of the audio source to the RINP (LINP) input and the negative lead from the audio source to the RINN (LINN) input. To use the TPA2000D4 with a single-ended source, ac ground the RINN and LINN inputs through a capacitor and apply the audio single to the RINP and LINP inputs. In a single-ended input application, the RINN and LINN inputs should be ac-grounded at the audio source instead of at the device inputs for best noise performance.

shutdown modes

The TPA2000D4 employs a shutdown mode of operation designed to reduce supply current, I_{DD} , to the absolute minimum level during periods of nonuse for battery-power conservation. The $\overline{\text{SHUTDOWN}}$ input terminal should be held high during normal operation when the amplifier is in use. Pulling $\overline{\text{SHUTDOWN}}$ low causes the outputs to mute and the amplifier to enter a low-current state, $I_{DD(SD)} = 0.05 \mu\text{A}$. $\overline{\text{SHUTDOWN}}$ should never be left unconnected because amplifier operation would be unpredictable.

using low-ESR capacitors

Low-ESR capacitors are recommended throughout this application section. A real (as opposed to ideal) capacitor can be modeled simply as a resistor in series with an ideal capacitor. The voltage drop across this resistor minimizes the beneficial effects of the capacitor in the circuit. The lower the equivalent value of this resistance the more the real capacitor behaves like an ideal capacitor.

TPA2000D4
STEREO 2-W CLASS-D AUDIO POWER AMPLIFIER
WITH STEREO HP AMPLIFIER

SLOS337A – DECEMBER 2000 – REVISED MAY 2003

APPLICATION INFORMATION

evaluation circuit

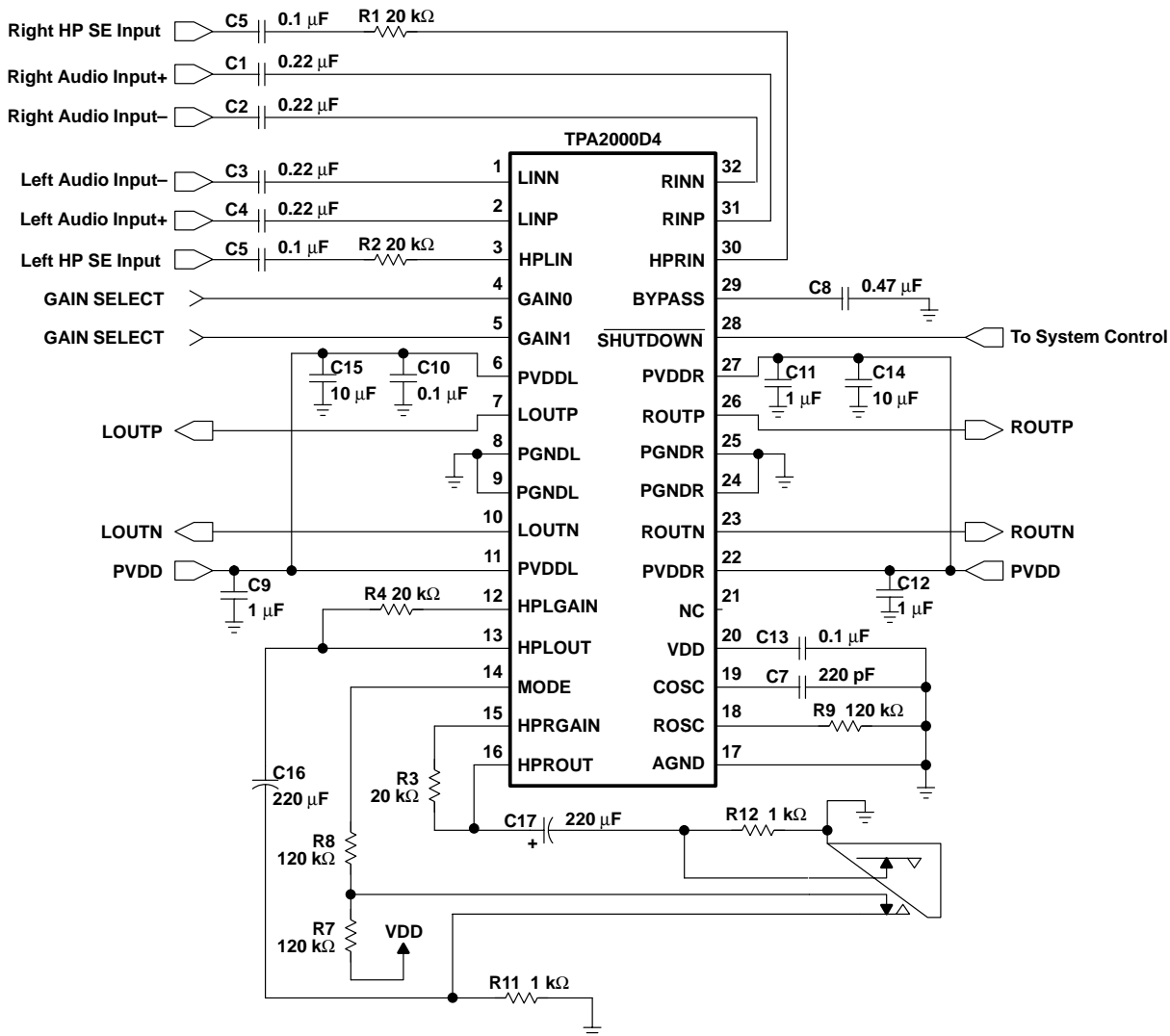

PACKAGING INFORMATION

Orderable Device	Status ⁽¹⁾	Package Type	Package Drawing	Pins	Package Qty	Eco Plan ⁽²⁾	Lead/Ball Finish	MSL Peak Temp ⁽³⁾
TPA2000D4DAP	ACTIVE	HTSSOP	DAP	32	46	None	CU NIPDAU	Level-1-220C-UNLIM
TPA2000D4DAPR	ACTIVE	HTSSOP	DAP	32	2000	None	CU NIPDAU	Level-1-220C-UNLIM

⁽¹⁾ The marketing status values are defined as follows:

ACTIVE: Product device recommended for new designs.

LIFEBUY: TI has announced that the device will be discontinued, and a lifetime-buy period is in effect.

NRND: Not recommended for new designs. Device is in production to support existing customers, but TI does not recommend using this part in a new design.

PREVIEW: Device has been announced but is not in production. Samples may or may not be available.

OBSOLETE: TI has discontinued the production of the device.

⁽²⁾ Eco Plan - May not be currently available - please check <http://www.ti.com/productcontent> for the latest availability information and additional product content details.

None: Not yet available Lead (Pb-Free).

Pb-Free (RoHS): TI's terms "Lead-Free" or "Pb-Free" mean semiconductor products that are compatible with the current RoHS requirements for all 6 substances, including the requirement that lead not exceed 0.1% by weight in homogeneous materials. Where designed to be soldered at high temperatures, TI Pb-Free products are suitable for use in specified lead-free processes.

Green (RoHS & no Sb/Br): TI defines "Green" to mean "Pb-Free" and in addition, uses package materials that do not contain halogens, including bromine (Br) or antimony (Sb) above 0.1% of total product weight.

⁽³⁾ MSL, Peak Temp. -- The Moisture Sensitivity Level rating according to the JEDEC industry standard classifications, and peak solder temperature.

Important Information and Disclaimer: The information provided on this page represents TI's knowledge and belief as of the date that it is provided. TI bases its knowledge and belief on information provided by third parties, and makes no representation or warranty as to the accuracy of such information. Efforts are underway to better integrate information from third parties. TI has taken and continues to take reasonable steps to provide representative and accurate information but may not have conducted destructive testing or chemical analysis on incoming materials and chemicals. TI and TI suppliers consider certain information to be proprietary, and thus CAS numbers and other limited information may not be available for release.

In no event shall TI's liability arising out of such information exceed the total purchase price of the TI part(s) at issue in this document sold by TI to Customer on an annual basis.

IMPORTANT NOTICE

Texas Instruments Incorporated and its subsidiaries (TI) reserve the right to make corrections, modifications, enhancements, improvements, and other changes to its products and services at any time and to discontinue any product or service without notice. Customers should obtain the latest relevant information before placing orders and should verify that such information is current and complete. All products are sold subject to TI's terms and conditions of sale supplied at the time of order acknowledgment.

TI warrants performance of its hardware products to the specifications applicable at the time of sale in accordance with TI's standard warranty. Testing and other quality control techniques are used to the extent TI deems necessary to support this warranty. Except where mandated by government requirements, testing of all parameters of each product is not necessarily performed.

TI assumes no liability for applications assistance or customer product design. Customers are responsible for their products and applications using TI components. To minimize the risks associated with customer products and applications, customers should provide adequate design and operating safeguards.

TI does not warrant or represent that any license, either express or implied, is granted under any TI patent right, copyright, mask work right, or other TI intellectual property right relating to any combination, machine, or process in which TI products or services are used. Information published by TI regarding third-party products or services does not constitute a license from TI to use such products or services or a warranty or endorsement thereof. Use of such information may require a license from a third party under the patents or other intellectual property of the third party, or a license from TI under the patents or other intellectual property of TI.

Reproduction of information in TI data books or data sheets is permissible only if reproduction is without alteration and is accompanied by all associated warranties, conditions, limitations, and notices. Reproduction of this information with alteration is an unfair and deceptive business practice. TI is not responsible or liable for such altered documentation.

Resale of TI products or services with statements different from or beyond the parameters stated by TI for that product or service voids all express and any implied warranties for the associated TI product or service and is an unfair and deceptive business practice. TI is not responsible or liable for any such statements.

Following are URLs where you can obtain information on other Texas Instruments products and application solutions:

Products		Applications	
Amplifiers	amplifier.ti.com	Audio	www.ti.com/audio
Data Converters	dataconverter.ti.com	Automotive	www.ti.com/automotive
DSP	dsp.ti.com	Broadband	www.ti.com/broadband
Interface	interface.ti.com	Digital Control	www.ti.com/digitalcontrol
Logic	logic.ti.com	Military	www.ti.com/military
Power Mgmt	power.ti.com	Optical Networking	www.ti.com/opticalnetwork
Microcontrollers	microcontroller.ti.com	Security	www.ti.com/security
		Telephony	www.ti.com/telephony
		Video & Imaging	www.ti.com/video
		Wireless	www.ti.com/wireless

Mailing Address: Texas Instruments
Post Office Box 655303 Dallas, Texas 75265