

TPS7101Q, TPS7133Q, TPS7148Q, TPS7150Q  
 TPS7101Y, TPS7133Y, TPS7148Y, TPS7150Y  
**LOW-DROPOUT VOLTAGE REGULATORS**

SLVS092G – NOVEMBER 1994 – REVISED JANUARY 2003

- Available in 5-V, 4.85-V, and 3.3-V Fixed-Output and Adjustable Versions
- Very Low-Dropout Voltage . . . Maximum of 32 mV at  $I_O = 100$  mA (TPS7150)
- Very Low Quiescent Current – Independent of Load . . . 285  $\mu$ A Typ
- Extremely Low Sleep-State Current  
0.5  $\mu$ A Max
- 2% Tolerance Over Specified Conditions For Fixed-Output Versions
- Output Current Range of 0 mA to 500 mA
- TSSOP Package Option Offers Reduced Component Height for Space-Critical Applications
- Power-Good (PG) Status Output

**description**

The TPS71xx integrated circuits are a family of micropower low-dropout (LDO) voltage regulators. An order of magnitude reduction in dropout voltage and quiescent current over conventional LDO performance is achieved by replacing the typical pnp pass transistor with a PMOS device.

Because the PMOS device behaves as a low-value resistor, the dropout voltage is very low (maximum of 32 mV at an output current of 100 mA for the TPS7150) and is directly proportional to the output current (see Figure 1). Additionally, since the PMOS pass element is a voltage-driven device, the quiescent current is very low and remains independent of output loading (typically 285  $\mu$ A over the full range of output current, 0 mA to 500 mA). These two key specifications yield a significant improvement in operating life for battery-powered systems. The LDO family also features a sleep mode; applying a TTL high signal to  $\overline{EN}$  (enable) shuts down the regulator, reducing the quiescent current to 0.5  $\mu$ A maximum at  $T_J = 25^\circ\text{C}$ .

**D OR P PACKAGE  
(TOP VIEW)**

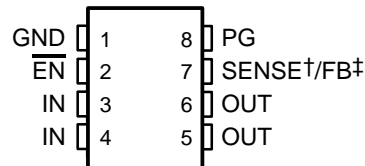

**PW PACKAGE  
(TOP VIEW)**

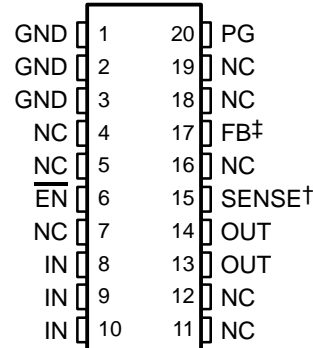

NC – No internal connection  
 † SENSE – Fixed voltage options only (TPS7133, TPS7148, and TPS7150)  
 ‡ FB – Adjustable version only (TPS7101)



Please be aware that an important notice concerning availability, standard warranty, and use in critical applications of Texas Instruments semiconductor products and disclaimers thereto appears at the end of this data sheet.

PRODUCTION DATA information is current as of publication date. Products conform to specifications per the terms of Texas Instruments standard warranty. Production processing does not necessarily include testing of all parameters.



POST OFFICE BOX 655303 • DALLAS, TEXAS 75265

Copyright © 2003, Texas Instruments Incorporated

**TPS7101Q, TPS7133Q, TPS7148Q, TPS7150Q**  
**TPS7101Y, TPS7133Y, TPS7148Y, TPS7150Y**  
**LOW-DROPOUT VOLTAGE REGULATORS**

SLVS092G – NOVEMBER 1994 – REVISED JANUARY 2003

**description (continued)**

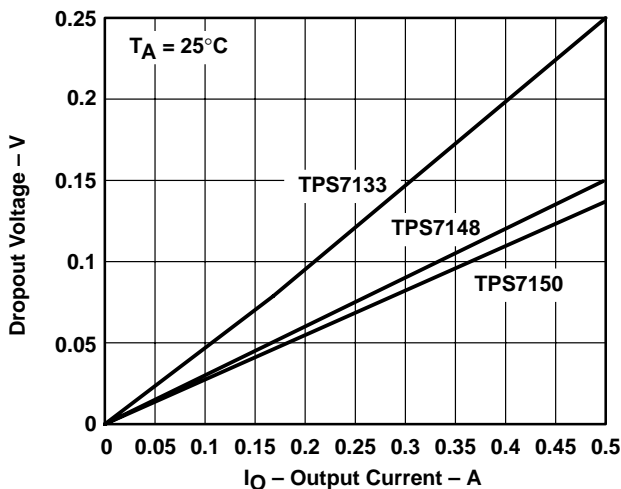

**Figure 1. Dropout Voltage Versus Output Current**

Power good (PG) reports low output voltage and can be used to implement a power-on reset or a low-battery indicator.

The TPS71xx is offered in 3.3-V, 4.85-V, and 5-V fixed-voltage versions and in an adjustable version (programmable over the range of 1.2 V to 9.75 V). Output voltage tolerance is specified as a maximum of 2% over line, load, and temperature ranges (3% for adjustable version). The TPS71xx family is available in PDIP (8 pin), SO (8 pin), and TSSOP (20-pin) packages. The TSSOP has a maximum height of 1,2 mm.

**AVAILABLE OPTIONS**

T <sub>J</sub>	OUTPUT VOLTAGE (V)			PACKAGED DEVICES			CHIP FORM (Y)
	MIN	TYP	MAX	SMALL OUTLINE (D)	PLASTIC DIP (P)	TSSOP (PW)	
-40°C to 125°C	4.9	5	5.1	TPS7150QD	TPS7150QP	TPS7150QPW	TPS7150Y
	4.75	4.85	4.95	TPS7148QD	TPS7148QP	TPS7148QPW	TPS7148Y
	3.23	3.3	3.37	TPS7133QD	TPS7133QP	TPS7133QPW	TPS7133Y
	Adjustable† 1.2 V to 9.75 V			TPS7101QD	TPS7101QP	TPS7101QPW	TPS7101Y

† The D and PW packages are available taped and reeled. Add R suffix to device type (e.g., TPS7150QDR). The TPS7101Q is programmable using an external resistor divider (see application information). The chip form is tested at 25°C.



TPS7101Q, TPS7133Q, TPS7148Q, TPS7150Q  
 TPS7101Y, TPS7133Y, TPS7148Y, TPS7150Y  
**LOW-DROPOUT VOLTAGE REGULATORS**

SLVS092G – NOVEMBER 1994 – REVISED JANUARY 2003

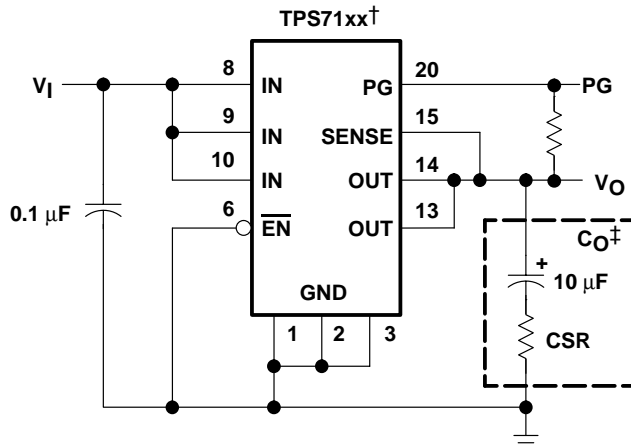

† TPS7133, TPS7148, TPS7150 (fixed-voltage options)

‡ Capacitor selection is nontrivial. See application information section for details.

**Figure 2. Typical Application Configuration**

**TPS71xx chip information**

These chips, when properly assembled, display characteristics similar to the TPS71xxQ. Thermal compression or ultrasonic bonding may be used on the doped aluminum bonding pads. The chips may be mounted with conductive epoxy or a gold-silicon preform.

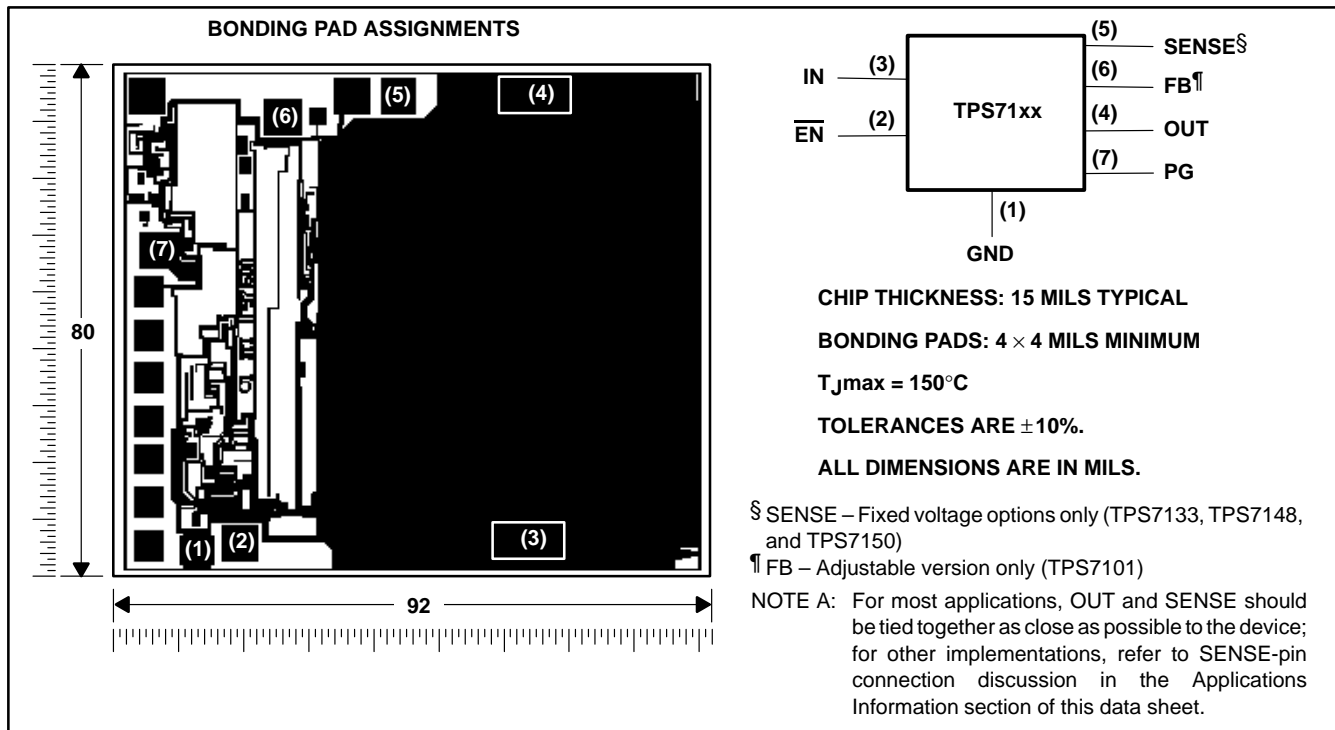

# TPS7101Q, TPS7133Q, TPS7148Q, TPS7150Q TPS7101Y, TPS7133Y, TPS7148Y, TPS7150Y LOW-DROPOUT VOLTAGE REGULATORS

SLVS092G – NOVEMBER 1994 – REVISED JANUARY 2003

## functional block diagram

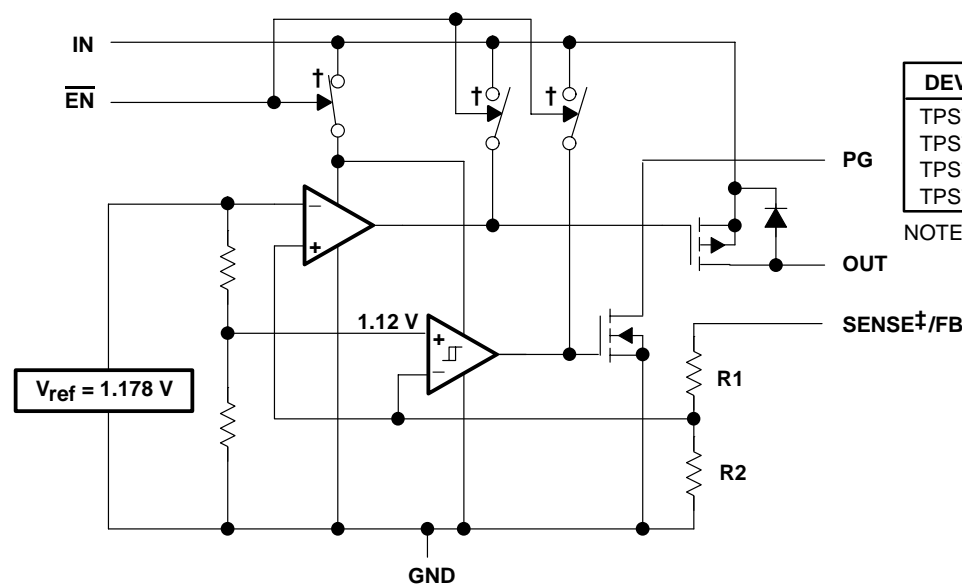

### RESISTOR DIVIDER OPTIONS

DEVICE	R1	R2	UNIT
TPS7101	0	∞	Ω
TPS7133	420	233	kΩ
TPS7148	726	233	kΩ
TPS7150	756	233	kΩ

NOTE A: Resistors are nominal values only.

### COMPONENT COUNT

MOS transistors	464
Bipolar transistors	41
Diodes	4
Capacitors	17
Resistors	76

† Switch positions are shown with  $\overline{EN}$  low (active).

‡ For most applications, SENSE should be externally connected to OUT as close as possible to the device. For other implementations, refer to SENSE-pin connection discussion in Applications Information section.

## absolute maximum ratings over operating free-air temperature range (unless otherwise noted)§

Input voltage range <sup>¶</sup> , $V_I$ , PG, SENSE, $\overline{EN}$	–0.3 V to 11 V
Output current, $I_O$	2 A
Continuous total power dissipation	See Dissipation Rating Tables 1 and 2
Operating virtual junction temperature range, $T_J$	–55°C to 150°C
Storage temperature range, $T_{stg}$	–65°C to 150°C
Lead temperature 1,6 mm (1/16 inch) from case for 10 seconds	260°C

§ Stresses beyond those listed under “absolute maximum ratings” may cause permanent damage to the device. These are stress ratings only, and functional operation of the device at these or any other conditions beyond those indicated under “recommended operating conditions” is not implied. Exposure to absolute-maximum-rated conditions for extended periods may affect device reliability.

¶ All voltage values are with respect to network terminal ground.

DISSIPATION RATING TABLE 1 – FREE-AIR TEMPERATURE (see Figure 3)<sup>#</sup>

PACKAGE	$T_A \leq 25^\circ\text{C}$ POWER RATING	DERATING FACTOR ABOVE $T_A = 25^\circ\text{C}$	$T_A = 70^\circ\text{C}$ POWER RATING	$T_A = 125^\circ\text{C}$ POWER RATING
D	725 mW	5.8 mW/°C	464 mW	145 mW
P	1175 mW	9.4 mW/°C	752 mW	235 mW
PW	700 mW	5.6 mW/°C	448 mW	140 mW

DISSIPATION RATING TABLE 2 – CASE TEMPERATURE (see Figure 4)<sup>#</sup>

PACKAGE	$T_C \leq 25^\circ\text{C}$ POWER RATING	DERATING FACTOR ABOVE $T_C = 25^\circ\text{C}$	$T_C = 70^\circ\text{C}$ POWER RATING	$T_C = 125^\circ\text{C}$ POWER RATING
D	2188 mW	17.5 mW/°C	1400 mW	438 mW
P	2738 mW	21.9 mW/°C	1752 mW	548 mW
PW	4025 mW	32.2 mW/°C	2576 mW	805 mW

<sup>#</sup> Dissipation rating tables and figures are provided for maintenance of junction temperature at or below absolute maximum temperature of 150°C. For guidelines on maintaining junction temperature within recommended operating range, see the Thermal Information section.

|| Refer to Thermal Information section for detailed power dissipation considerations when using the TSSOP packages.



TPS7101Q, TPS7133Q, TPS7148Q, TPS7150Q  
 TPS7101Y, TPS7133Y, TPS7148Y, TPS7150Y  
**LOW-DROPOUT VOLTAGE REGULATORS**

SLVS092G – NOVEMBER 1994 – REVISED JANUARY 2003

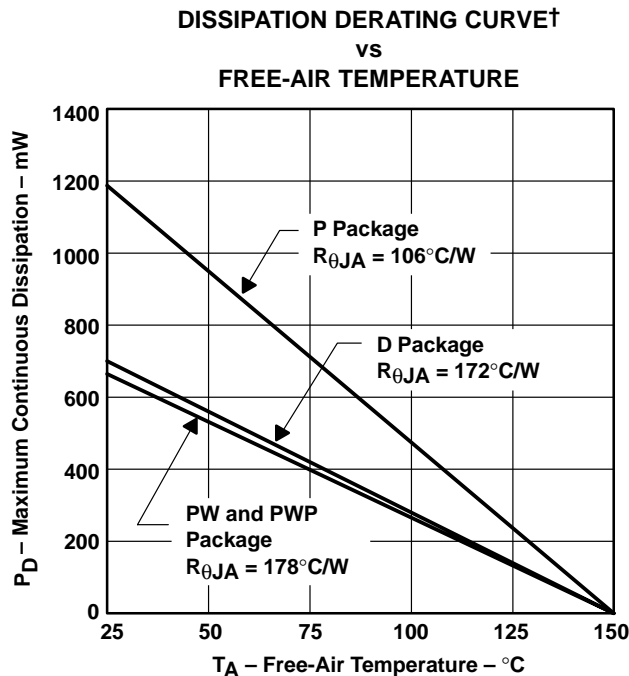

**Figure 3**

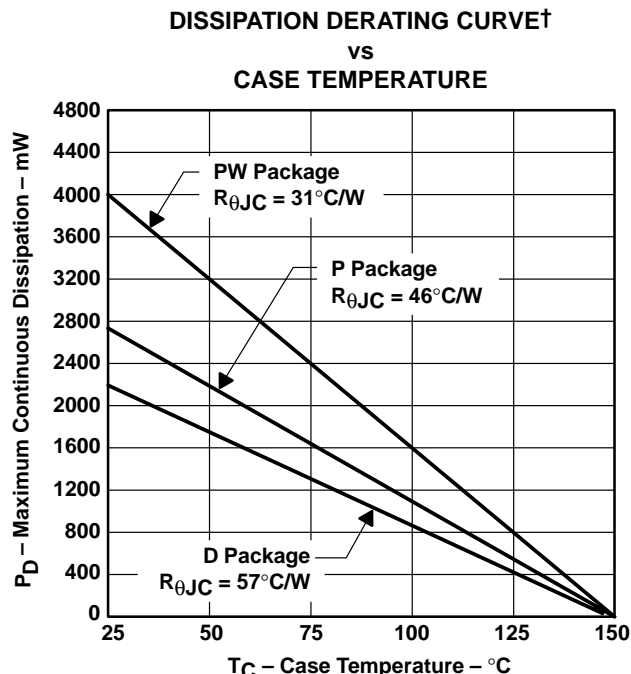

**Figure 4**

† Dissipation rating tables and figures are provided for maintenance of junction temperature at or below absolute maximum temperature of 150°C. For guidelines on maintaining junction temperature within recommended operating range, see the Thermal Information section.

**recommended operating conditions**

	MIN	MAX	UNIT	
Input voltage, $V_I$ ‡	TPS7101Q	2.5	10	V
	TPS7133Q	3.77	10	
	TPS7148Q	5.2	10	
	TPS7150Q	5.33	10	
High-level input voltage at $\overline{EN}$ , $V_{IH}$	2		V	
Low-level input voltage at $\overline{EN}$ , $V_{IL}$		0.5	V	
Output current range, $I_O$	0	500	mA	
Operating virtual junction temperature range, $T_J$	-40	125	°C	

‡ Minimum input voltage defined in the recommended operating conditions is the maximum specified output voltage plus dropout voltage at the maximum specified load range. Since dropout voltage is a function of output current, the usable range can be extended for lighter loads. To calculate the minimum input voltage for your maximum output current, use the following equation:  $V_{I(\min)} = V_{O(\max)} + V_{DO(\max \text{ load})}$ . Because the TPS7101 is programmable,  $r_{DS(on)}$  should be used to calculate  $V_{DO}$  before applying the above equation. The equation for calculating  $V_{DO}$  from  $r_{DS(on)}$  is given in Note 2 in the electrical characteristics table. The minimum value of 2.5 V is the absolute lower limit for the recommended input voltage range for the TPS7101.

**TPS7101Q, TPS7133Q, TPS7148Q, TPS7150Q**  
**TPS7101Y, TPS7133Y, TPS7148Y, TPS7150Y**  
**LOW-DROPOUT VOLTAGE REGULATORS**

SLVS092G – NOVEMBER 1994 – REVISED JANUARY 2003

**electrical characteristics at  $I_O = 10\text{ mA}$ ,  $\overline{EN} = 0\text{ V}$ ,  $C_O = 4.7\text{ }\mu\text{F/CSRT} = 1\text{ }\Omega$ , SENSE/FB shorted to OUT (unless otherwise noted)**

PARAMETER	TEST CONDITIONS†	T <sub>J</sub>	TPS7101Q, TPS7133Q TPS7148Q, TPS7150Q			UNIT
			MIN	TYP	MAX	
Ground current (active mode)	$\overline{EN} \leq 0.5\text{ V}$ , $V_I = V_O + 1\text{ V}$ , $0\text{ mA} \leq I_O \leq 500\text{ mA}$	25°C	285	350	μA	
		-40°C to 125°C	460			
Input current (standby mode)	$\overline{EN} = V_I$ , $2.7\text{ V} \leq V_I \leq 10\text{ V}$	25°C	0.5		μA	
		-40°C to 125°C	2			
Output current limit	$V_O = 0$ , $V_I = 10\text{ V}$	25°C	1.2	2	A	
		-40°C to 125°C	2			
Pass-element leakage current in standby mode	$\overline{EN} = V_I$ , $2.7\text{ V} \leq V_I \leq 10\text{ V}$	25°C	0.5		μA	
		-40°C to 125°C	1			
PG leakage current	Normal operation, $V_{PG} = 10\text{ V}$	25°C	0.02	0.5	μA	
		-40°C to 125°C	0.5			
Output voltage temperature coefficient		-40°C to 125°C	61	75	ppm/°C	
Thermal shutdown junction temperature			165		°C	
EN logic high (standby mode)	$2.5\text{ V} \leq V_I \leq 6\text{ V}$	-40°C to 125°C	2		V	
	$6\text{ V} \leq V_I \leq 10\text{ V}$		2.7			
$\overline{EN}$ logic low (active mode)	$2.7\text{ V} \leq V_I \leq 10\text{ V}$	25°C	0.5		V	
		-40°C to 125°C	0.5			
$\overline{EN}$ hysteresis voltage		25°C	50		mV	
$\overline{EN}$ input current	$0\text{ V} \leq V_I \leq 10\text{ V}$ $0\text{ V} \leq V_I \leq 10\text{ V}$	25°C	-0.5	0.5	μA	
		-40°C to 125°C	-0.5	0.5		
Minimum $V_I$ for active pass element		25°C	2.05	2.5	V	
		-40°C to 125°C	2.5			
Minimum $V_I$ for valid PG	$I_{PG} = 300\text{ }\mu\text{A}$ $I_{PG} = 300\text{ }\mu\text{A}$	25°C	1.06	1.5	V	
		-40°C to 125°C	1.9			

† CSR (compensation series resistance) refers to the total series resistance, including the equivalent series resistance (ESR) of the capacitor, any series resistance added externally, and PWB trace resistance to  $C_O$ .

‡ Pulse-testing techniques are used to maintain virtual junction temperature as close as possible to ambient temperature; thermal effects must be taken into account separately.

TPS7101Q, TPS7133Q, TPS7148Q, TPS7150Q  
 TPS7101Y, TPS7133Y, TPS7148Y, TPS7150Y  
 LOW-DROPOUT VOLTAGE REGULATORS

SLVS092G – NOVEMBER 1994 – REVISED JANUARY 2003

TPS7101 electrical characteristics at  $I_O = 10\text{ mA}$ ,  $V_I = 3.5\text{ V}$ ,  $\overline{EN} = 0\text{ V}$ ,  $C_O = 4.7\text{ }\mu\text{F}/\text{CSR}^\dagger = 1\text{ }\Omega$ , FB shorted to OUT at device leads (unless otherwise noted)

PARAMETER	TEST CONDITIONS <sup>‡</sup>		T <sub>J</sub>	TPS7101Q			UNIT
				MIN	TYP	MAX	
Reference voltage (measured at FB with OUT connected to FB)	$V_I = 3.5\text{ V}$ ,	$I_O = 10\text{ mA}$	25°C	1.178			V
	$2.5\text{ V} \leq V_I \leq 10\text{ V}$ , See Note 1	$5\text{ mA} \leq I_O \leq 500\text{ mA}$ ,	-40°C to 125°C	1.143	1.213		V
Reference voltage temperature coefficient			-40°C to 125°C	61	75		ppm/°C
Pass-element series resistance (see Note 2)	$V_I = 2.4\text{ V}$ ,	$50\text{ }\mu\text{A} \leq I_O \leq 150\text{ mA}$	25°C	0.7		1	$\Omega$
			-40°C to 125°C			1	
	$V_I = 2.4\text{ V}$ ,	$150\text{ mA} \leq I_O \leq 500\text{ mA}$	25°C	0.83		1.3	
			-40°C to 125°C			1.3	
	$V_I = 2.9\text{ V}$ ,	$50\text{ }\mu\text{A} \leq I_O \leq 500\text{ mA}$	25°C	0.52		0.85	
			-40°C to 125°C			0.85	
Input regulation	$V_I = 2.5\text{ V to } 10\text{ V}$ , See Note 1	$50\text{ }\mu\text{A} \leq I_O \leq 500\text{ mA}$ ,	25°C			18	mV
			-40°C to 125°C			25	
Output regulation	$I_O = 5\text{ mA to } 500\text{ mA}$ , See Note 1	$2.5\text{ V} \leq V_I \leq 10\text{ V}$ ,	25°C			14	mV
			-40°C to 125°C			25	
	$I_O = 50\text{ }\mu\text{A to } 500\text{ mA}$ , See Note 1	$2.5\text{ V} \leq V_I \leq 10\text{ V}$ ,	25°C			22	mV
			-40°C to 125°C			54	
Ripple rejection	$f = 120\text{ Hz}$	$I_O = 50\text{ }\mu\text{A}$	25°C	48	59		dB
			-40°C to 125°C	44			
		$I_O = 500\text{ mA}$ , See Note 1	25°C	45	54		
			-40°C to 125°C	44			
Output noise-spectral density	$f = 120\text{ Hz}$		25°C	2		$\mu\text{V}/\sqrt{\text{Hz}}$	
Output noise voltage	$10\text{ Hz} \leq f \leq 100\text{ kHz}$ , $\text{CSR}^\dagger = 1\text{ }\Omega$	$C_O = 4.7\text{ }\mu\text{F}$	25°C	95		$\mu\text{V}_{\text{rms}}$	
		$C_O = 10\text{ }\mu\text{F}$	25°C	89			
		$C_O = 100\text{ }\mu\text{F}$	25°C	74			
PG trip-threshold voltage <sup>§</sup>	$V_{\text{FB}}$ voltage decreasing from above $V_{\text{PG}}$		-40°C to 125°C	1.101	1.145		V
PG hysteresis voltage <sup>§</sup>	Measured at $V_{\text{FB}}$		25°C	12		mV	
PG output low voltage <sup>§</sup>	$I_{\text{PG}} = 400\text{ }\mu\text{A}$ ,	$V_I = 2.13\text{ V}$	25°C	0.1	0.4		V
			-40°C to 125°C	0.4			
FB input current			25°C	-10	0.1	10	nA
			-40°C to 125°C	-20	20		

<sup>†</sup> CSR refers to the total series resistance, including the ESR of the capacitor, any series resistance added externally, and PWB trace resistance to  $C_O$ .

<sup>‡</sup> Pulse-testing techniques are used to maintain virtual junction temperature as close as possible to ambient temperature; thermal effects must be taken into account separately.

<sup>§</sup> Output voltage programmed to 2.5 V with closed-loop configuration (see application information).

NOTES: 1. When  $V_I < 2.9\text{ V}$  and  $I_O > 150\text{ mA}$  simultaneously, pass element  $r_{\text{DS(on)}}$  increases (see Figure 27) to a point such that the resulting dropout voltage prevents the regulator from maintaining the specified tolerance range.

2. To calculate dropout voltage, use equation:

$$V_{\text{DO}} = I_O \cdot r_{\text{DS(on)}}$$

$r_{\text{DS(on)}}$  is a function of both output current and input voltage. The parametric table lists  $r_{\text{DS(on)}}$  for  $V_I = 2.4\text{ V}$ ,  $2.9\text{ V}$ ,  $3.9\text{ V}$ , and  $5.9\text{ V}$ , which corresponds to dropout conditions for programmed output voltages of 2.5 V, 3 V, 4 V, and 6 V, respectively. For other programmed values, refer to Figure 26.



**TPS7101Q, TPS7133Q, TPS7148Q, TPS7150Q**  
**TPS7101Y, TPS7133Y, TPS7148Y, TPS7150Y**  
**LOW-DROPOUT VOLTAGE REGULATORS**

SLVS092G – NOVEMBER 1994 – REVISED JANUARY 2003

**TPS7133 electrical characteristics at  $I_O = 10\text{ mA}$ ,  $V_I = 4.3\text{ V}$ ,  $\overline{EN} = 0\text{ V}$ ,  $C_O = 4.7\text{ }\mu\text{F}/\text{CSR}\dagger = 1\text{ }\Omega$ , SENSE shorted to OUT (unless otherwise noted)**

PARAMETER	TEST CONDITIONS‡		T <sub>J</sub>	TPS7133Q			UNIT
				MIN	TYP	MAX	
Output voltage	$V_I = 4.3\text{ V}$ , $I_O = 10\text{ mA}$		25°C	3.3			V
	$4.3\text{ V} \leq V_I \leq 10\text{ V}$ , $5\text{ mA} \leq I_O \leq 500\text{ mA}$		-40°C to 125°C	3.23	3.37		
Dropout voltage	$I_O = 10\text{ mA}$ , $V_I = 3.23\text{ V}$		25°C	4.5	7		mV
			-40°C to 125°C	8			
	$I_O = 100\text{ mA}$ , $V_I = 3.23\text{ V}$		25°C	47	60		
			-40°C to 125°C	80			
	$I_O = 500\text{ mA}$ , $V_I = 3.23\text{ V}$		25°C	235	300		
			-40°C to 125°C	400			
Pass-element series resistance	$(3.23\text{ V} - V_O)/I_O$ , $I_O = 500\text{ mA}$	$V_I = 3.23\text{ V}$ ,	25°C	0.47	0.6		$\Omega$
			-40°C to 125°C	0.8			
Input regulation	$V_I = 4.3\text{ V to }10\text{ V}$ , $50\text{ }\mu\text{A} \leq I_O \leq 500\text{ mA}$		25°C	20		mV	
			-40°C to 125°C	27			
Output regulation	$I_O = 5\text{ mA to }500\text{ mA}$ , $4.3\text{ V} \leq V_I \leq 10\text{ V}$		25°C	21	38		mV
			-40°C to 125°C	75			
	$I_O = 50\text{ }\mu\text{A to }500\text{ mA}$ , $4.3\text{ V} \leq V_I \leq 10\text{ V}$		25°C	30	60		mV
			-40°C to 125°C	120			
Ripple rejection	$f = 120\text{ Hz}$	$I_O = 50\text{ }\mu\text{A}$	25°C	43	54		dB
			-40°C to 125°C	40			
		$I_O = 500\text{ mA}$	25°C	39	49		
			-40°C to 125°C	36			
Output noise-spectral density	$f = 120\text{ Hz}$		25°C	2		$\mu\text{V}/\sqrt{\text{Hz}}$	
Output noise voltage	$10\text{ Hz} \leq f \leq 100\text{ kHz}$ , $\text{CSR}\dagger = 1\text{ }\Omega$	$C_O = 4.7\text{ }\mu\text{F}$	25°C	274		$\mu\text{V}_{\text{rms}}$	
		$C_O = 10\text{ }\mu\text{F}$	25°C	228			
		$C_O = 100\text{ }\mu\text{F}$	25°C	159			
PG trip-threshold voltage	$V_O$ voltage decreasing from above $V_{\text{PG}}$		-40°C to 125°C	2.868	3		V
PG hysteresis voltage			25°C	35		mV	
PG output low voltage	$I_{\text{PG}} = 1\text{ mA}$ , $V_I = 2.8\text{ V}$		25°C	0.22	0.4		V
			-40°C to 125°C	0.4			

† CSR refers to the total series resistance, including the ESR of the capacitor, any series resistance added externally, and PWB trace resistance to  $C_O$ .

‡ Pulse-testing techniques are used to maintain virtual junction temperature as close as possible to ambient temperature; thermal effects must be taken into account separately.



TPS7101Q, TPS7133Q, TPS7148Q, TPS7150Q  
 TPS7101Y, TPS7133Y, TPS7148Y, TPS7150Y  
 LOW-DROPOUT VOLTAGE REGULATORS

SLVS092G – NOVEMBER 1994 – REVISED JANUARY 2003

TPS7148 electrical characteristics at  $I_O = 10\text{ mA}$ ,  $V_I = 5.85\text{ V}$ ,  $\overline{EN} = 0\text{ V}$ ,  $C_O = 4.7\text{ }\mu\text{F}/\text{CSRT}^\dagger = 1\text{ }\Omega$ , SENSE shorted to OUT (unless otherwise noted)

PARAMETER	TEST CONDITIONS <sup>‡</sup>		T <sub>J</sub>	TPS7148Q			UNIT
				MIN	TYP	MAX	
Output voltage	$V_I = 5.85\text{ V}$ ,	$I_O = 10\text{ mA}$	25°C	4.85			V
	$5.85\text{ V} \leq V_I \leq 10\text{ V}$ ,	$5\text{ mA} \leq I_O \leq 500\text{ mA}$	-40°C to 125°C	4.75	4.95		
Dropout voltage	$I_O = 10\text{ mA}$ ,	$V_I = 4.75\text{ V}$	25°C	2.9		6	mV
			-40°C to 125°C	8			
	$I_O = 100\text{ mA}$ ,	$V_I = 4.75\text{ V}$	25°C	30		37	
			-40°C to 125°C	54			
	$I_O = 500\text{ mA}$ ,	$V_I = 4.75\text{ V}$	25°C	150		180	
			-40°C to 125°C	250			
Pass-element series resistance	$(4.75\text{ V} - V_O)/I_O$ ,	$V_I = 4.75\text{ V}$ ,	25°C	0.32	0.35		$\Omega$
			$I_O = 500\text{ mA}$	-40°C to 125°C 0.52			
Input regulation	$V_I = 5.85\text{ V}$ to 10 V,	$50\text{ }\mu\text{A} \leq I_O \leq 500\text{ mA}$	25°C	27		mV	
			-40°C to 125°C	37			
Output regulation	$I_O = 5\text{ mA}$ to 500 mA,	$5.85\text{ V} \leq V_I \leq 10\text{ V}$	25°C	12	42		mV
			-40°C to 125°C	80			
	$I_O = 50\text{ }\mu\text{A}$ to 500 mA,	$5.85\text{ V} \leq V_I \leq 10\text{ V}$	25°C	42		60	mV
			-40°C to 125°C	130			
Ripple rejection	$f = 120\text{ Hz}$	$I_O = 50\text{ }\mu\text{A}$	25°C	42	53		dB
			-40°C to 125°C	39			
		$I_O = 500\text{ mA}$	25°C	39		50	
			-40°C to 125°C	35			
Output noise-spectral density	$f = 120\text{ Hz}$		25°C	2		$\mu\text{V}/\sqrt{\text{Hz}}$	
Output noise voltage	$10\text{ Hz} \leq f \leq 100\text{ kHz}$ ,	$C_O = 4.7\text{ }\mu\text{F}$	25°C	410		$\mu\text{V}_{\text{rms}}$	
		$C_O = 10\text{ }\mu\text{F}$	25°C	328			
		$C_O = 100\text{ }\mu\text{F}$	25°C	212			
PG trip-threshold voltage	$V_O$ voltage decreasing from above $V_{\text{PG}}$		-40°C to 125°C	4.5	4.7		V
PG hysteresis voltage			25°C	50		mV	
PG output low voltage	$I_{\text{PG}} = 1.2\text{ mA}$ ,	$V_I = 4.12\text{ V}$	25°C	0.2	0.4		V
			-40°C to 125°C	0.4			

<sup>†</sup> CSR refers to the total series resistance, including the ESR of the capacitor, any series resistance added externally, and PWB trace resistance to  $C_O$ .

<sup>‡</sup> Pulse-testing techniques are used to maintain virtual junction temperature as close as possible to ambient temperature; thermal effects must be taken into account separately.

**TPS7101Q, TPS7133Q, TPS7148Q, TPS7150Q**  
**TPS7101Y, TPS7133Y, TPS7148Y, TPS7150Y**  
**LOW-DROPOUT VOLTAGE REGULATORS**

SLVS092G – NOVEMBER 1994 – REVISED JANUARY 2003

**TPS7150 electrical characteristics at  $I_O = 10\text{ mA}$ ,  $V_I = 6\text{ V}$ ,  $\overline{EN} = 0\text{ V}$ ,  $C_O = 4.7\text{ }\mu\text{F/CSR}^\dagger = 1\text{ }\Omega$ , SENSE shorted to OUT (unless otherwise noted)**

PARAMETER	TEST CONDITIONS‡		T <sub>J</sub>	TPS7150Q			UNIT
				MIN	TYP	MAX	
Output voltage	$V_I = 6\text{ V}$ , $I_O = 10\text{ mA}$		25°C		5		V
	$6\text{ V} \leq V_I \leq 10\text{ V}$ , $5\text{ mA} \leq I_O \leq 500\text{ mA}$		-40°C to 125°C	4.9	5.1		
Dropout voltage	$I_O = 10\text{ mA}$ , $V_I = 4.88\text{ V}$		25°C		2.9	6	mV
			-40°C to 125°C			8	
	$I_O = 100\text{ mA}$ , $V_I = 4.88\text{ V}$		25°C		27	32	
			-40°C to 125°C			47	
	$I_O = 500\text{ mA}$ , $V_I = 4.88\text{ V}$		25°C		146	170	
			-40°C to 125°C			230	
Pass-element series resistance	$(4.88\text{ V} - V_O)/I_O$ , $I_O = 500\text{ mA}$	$V_I = 4.88\text{ V}$ ,	25°C		0.29	0.32	$\Omega$
			-40°C to 125°C			0.47	
Input regulation	$V_I = 6\text{ V to }10\text{ V}$ , $50\text{ }\mu\text{A} \leq I_O \leq 500\text{ mA}$		25°C			25	mV
			-40°C to 125°C				
Output regulation	$I_O = 5\text{ mA to }500\text{ mA}$ , $6\text{ V} \leq V_I \leq 10\text{ V}$		25°C		30	45	mV
			-40°C to 125°C				
	$I_O = 50\text{ }\mu\text{A to }500\text{ mA}$ , $6\text{ V} \leq V_I \leq 10\text{ V}$		25°C		45	65	mV
			-40°C to 125°C				
Ripple rejection	$f = 120\text{ Hz}$	$I_O = 50\text{ }\mu\text{A}$	25°C		45	55	dB
			-40°C to 125°C			40	
		$I_O = 500\text{ mA}$	25°C		42	52	
			-40°C to 125°C			36	
Output noise-spectral density	$f = 120\text{ Hz}$		25°C		2	$\mu\text{V}/\sqrt{\text{Hz}}$	
Output noise voltage	$10\text{ Hz} \leq f \leq 100\text{ kHz}$ , $\text{CSR}^\dagger = 1\text{ }\Omega$	$C_O = 4.7\text{ }\mu\text{F}$	25°C		430	$\mu\text{V}_{\text{rms}}$	
		$C_O = 10\text{ }\mu\text{F}$	25°C		345		
		$C_O = 100\text{ }\mu\text{F}$	25°C		220		
PG trip-threshold voltage	$V_O$ voltage decreasing from above $V_{\text{PG}}$		-40°C to 125°C	4.55	4.75	V	
PG hysteresis voltage			25°C		53	mV	
PG output low voltage	$I_{\text{PG}} = 1.2\text{ mA}$ , $V_I = 4.25\text{ V}$		25°C		0.2	0.4	V
			-40°C to 125°C			0.4	

† CSR refers to the total series resistance, including the ESR of the capacitor, any series resistance added externally, and PWB trace resistance to  $C_O$ .

‡ Pulse-testing techniques are used to maintain virtual junction temperature as close as possible to ambient temperature; thermal effects must be taken into account separately.



TPS7101Q, TPS7133Q, TPS7148Q, TPS7150Q  
 TPS7101Y, TPS7133Y, TPS7148Y, TPS7150Y  
 LOW-DROPOUT VOLTAGE REGULATORS

SLVS092G – NOVEMBER 1994 – REVISED JANUARY 2003

electrical characteristics at  $I_O = 10\text{ mA}$ ,  $\overline{EN} = 0\text{ V}$ ,  $C_O = 4.7\text{ }\mu\text{F}/\text{CSR}^\dagger = 1\text{ }\Omega$ ,  $T_J = 25^\circ\text{C}$ , SENSE/FB shorted to OUT (unless otherwise noted)

PARAMETER	TEST CONDITIONS‡	TPS7101Y, TPS7133Y TPS7148Y, TPS7150Y			UNIT
		MIN	TYP	MAX	
Ground current (active mode)	$\overline{EN} \leq 0.5\text{ V}$ , $0\text{ mA} \leq I_O \leq 500\text{ mA}$		285		$\mu\text{A}$
Output current limit	$V_O = 0$ , $V_I = 10\text{ V}$		1.2		A
PG leakage current	Normal operation, $V_{PG} = 10\text{ V}$		0.02		$\mu\text{A}$
Thermal shutdown junction temperature			165		$^\circ\text{C}$
$\overline{EN}$ hysteresis voltage			50		mV
Minimum $V_I$ for active pass element			2.05		V
Minimum $V_I$ for valid PG	$I_{PG} = 300\text{ }\mu\text{A}$		1.06		V

PARAMETER	TEST CONDITIONS‡	TPS7101Y			UNIT
		MIN	TYP	MAX	
Reference voltage (measured at FB with OUT connected to FB)	$V_I = 3.5\text{ V}$ , $I_O = 10\text{ mA}$		1.178		V
Pass-element series resistance (see Note 2)	$V_I = 2.4\text{ V}$ , $50\text{ }\mu\text{A} \leq I_O \leq 150\text{ mA}$		0.7		$\Omega$
	$V_I = 2.4\text{ V}$ , $150\text{ mA} \leq I_O \leq 500\text{ mA}$		0.83		
	$V_I = 2.9\text{ V}$ , $50\text{ }\mu\text{A} \leq I_O \leq 500\text{ mA}$		0.52		
	$V_I = 3.9\text{ V}$ , $50\text{ }\mu\text{A} \leq I_O \leq 500\text{ mA}$		0.32		
	$V_I = 5.9\text{ V}$ , $50\text{ }\mu\text{A} \leq I_O \leq 500\text{ mA}$		0.23		
Input regulation	$V_I = 2.5\text{ V to } 10\text{ V}$ , See Note 1			18	mV
Output regulation	$2.5\text{ V} \leq V_I \leq 10\text{ V}$ , See Note 1			14	mV
	$2.5\text{ V} \leq V_I \leq 10\text{ V}$ , See Note 1			22	mV
Ripple rejection	$V_I = 3.5\text{ V}$ , $I_O = 50\text{ }\mu\text{A}$		59		dB
Output noise-spectral density	$V_I = 3.5\text{ V}$ , $f = 120\text{ Hz}$		2		$\mu\text{V}/\sqrt{\text{Hz}}$
Output noise voltage	$V_I = 3.5\text{ V}$ , $10\text{ Hz} \leq f \leq 100\text{ kHz}$ , $\text{CSR}^\dagger = 1\text{ }\Omega$	$C_O = 4.7\text{ }\mu\text{F}$	95		$\mu\text{V}_{\text{rms}}$
		$C_O = 10\text{ }\mu\text{F}$	89		
		$C_O = 100\text{ }\mu\text{F}$	74		
PG hysteresis voltage§	$V_I = 3.5\text{ V}$ , Measured at $V_{FB}$		12		mV
PG output low voltage§	$V_I = 2.13\text{ V}$ , $I_{PG} = 400\text{ }\mu\text{A}$		0.1		V
FB input current	$V_I = 3.5\text{ V}$		0.1		nA

† CSR refers to the total series resistance, including the ESR of the capacitor, any series resistance added externally, and PWB trace resistance to  $C_O$ .

‡ Pulse-testing techniques are used to maintain virtual junction temperature as close as possible to ambient temperature; thermal effects must be taken into account separately.

§ Output voltage programmed to 2.5 V with closed-loop configuration (see application information).

NOTES: 1. When  $V_I < 2.9\text{ V}$  and  $I_O > 150\text{ mA}$  simultaneously, pass element  $r_{DS(on)}$  increases (see Figure 27) to a point such that the resulting dropout voltage prevents the regulator from maintaining the specified tolerance range.

2. To calculate dropout voltage, use equation:

$$V_{DO} = I_O \cdot r_{DS(on)}$$

$r_{DS(on)}$  is a function of both output current and input voltage. The parametric table lists  $r_{DS(on)}$  for  $V_I = 2.4\text{ V}$ ,  $2.9\text{ V}$ ,  $3.9\text{ V}$ , and  $5.9\text{ V}$ , which corresponds to dropout conditions for programmed output voltages of 2.5 V, 3 V, 4 V, and 6 V, respectively. For other programmed values, refer to Figure 26.



**TPS7101Q, TPS7133Q, TPS7148Q, TPS7150Q  
 TPS7101Y, TPS7133Y, TPS7148Y, TPS7150Y  
 LOW-DROPOUT VOLTAGE REGULATORS**

SLVS092G – NOVEMBER 1994 – REVISED JANUARY 2003

**electrical characteristics at  $I_O = 10\text{ mA}$ ,  $\overline{EN} = 0\text{ V}$ ,  $C_O = 4.7\text{ }\mu\text{F}/\text{CSR}^\dagger = 1\text{ }\Omega$ ,  $T_J = 25^\circ\text{C}$ , SENSE shorted to OUT (unless otherwise noted) (continued)**

PARAMETER	TEST CONDITIONS‡	TPS7133Y			UNIT
		MIN	TYP	MAX	
Output voltage	$V_I = 4.3\text{ V}$ , $I_O = 10\text{ mA}$	3.3			V
Dropout voltage	$V_I = 3.23\text{ V}$ , $I_O = 10\text{ mA}$	0.02			mV
	$V_I = 3.23\text{ V}$ , $I_O = 100\text{ mA}$	47			
	$V_I = 3.23\text{ V}$ , $I_O = 500\text{ mA}$	235			
Pass-element series resistance	$(3.23\text{ V} - V_O)/I_O$ , $I_O = 500\text{ mA}$ , $V_I = 3.23\text{ V}$	0.47			$\Omega$
Output regulation	$4.3\text{ V} \leq V_I \leq 10\text{ V}$ , $I_O = 5\text{ mA to }500\text{ mA}$	21			mV
	$4.3\text{ V} \leq V_I \leq 10\text{ V}$ , $I_O = 50\text{ }\mu\text{A to }500\text{ mA}$	30			mV
Ripple rejection	$V_I = 4.3\text{ V}$ , $f = 120\text{ Hz}$ , $I_O = 50\text{ }\mu\text{A}$	54			dB
	$I_O = 500\text{ mA}$	49			
Output noise-spectral density	$V_I = 4.3\text{ V}$ , $f = 120\text{ Hz}$	2			$\mu\text{V}/\sqrt{\text{Hz}}$
Output noise voltage	$V_I = 4.3\text{ V}$ , $10\text{ Hz} \leq f \leq 100\text{ kHz}$ , $\text{CSR}^\dagger = 1\text{ }\Omega$	$C_O = 4.7\text{ }\mu\text{F}$	274		$\mu\text{Vrms}$
		$C_O = 10\text{ }\mu\text{F}$	228		
		$C_O = 100\text{ }\mu\text{F}$	159		
PG hysteresis voltage	$V_I = 4.3\text{ V}$	35			mV
PG output low voltage	$V_I = 2.8\text{ V}$ , $I_{PG} = 1\text{ mA}$	0.22			V

PARAMETER	TEST CONDITIONS‡	TPS7148Y			UNIT
		MIN	TYP	MAX	
Output voltage	$V_I = 5.85\text{ V}$ , $I_O = 10\text{ mA}$	4.85			V
Dropout voltage	$V_I = 4.75\text{ V}$ , $I_O = 10\text{ mA}$	0.08			mV
	$V_I = 4.75\text{ V}$ , $I_O = 100\text{ mA}$	30			
	$V_I = 4.75\text{ V}$ , $I_O = 500\text{ mA}$	150			
Pass-element series resistance	$(4.75\text{ V} - V_O)/I_O$ , $I_O = 500\text{ mA}$ , $V_I = 4.75\text{ V}$	0.32			$\Omega$
Output regulation	$5.85\text{ V} \leq V_I \leq 10\text{ V}$ , $I_O = 5\text{ mA to }500\text{ mA}$	12			mV
	$5.85\text{ V} \leq V_I \leq 10\text{ V}$ , $I_O = 50\text{ }\mu\text{A to }500\text{ mA}$	42			mV
Ripple rejection	$V_I = 5.85\text{ V}$ , $f = 120\text{ Hz}$ , $I_O = 50\text{ }\mu\text{A}$	53			dB
	$I_O = 500\text{ mA}$	50			
Output noise-spectral density	$V_I = 5.85\text{ V}$ , $f = 120\text{ Hz}$	2			$\mu\text{V}/\sqrt{\text{Hz}}$
Output noise voltage	$V_I = 5.85\text{ V}$ , $10\text{ Hz} \leq f \leq 100\text{ kHz}$ , $\text{CSR}^\dagger = 1\text{ }\Omega$	$C_O = 4.7\text{ }\mu\text{F}$	410		$\mu\text{Vrms}$
		$C_O = 10\text{ }\mu\text{F}$	328		
		$C_O = 100\text{ }\mu\text{F}$	212		
PG hysteresis voltage	$V_I = 5.85\text{ V}$	50			mV
PG output low voltage	$V_I = 4.12\text{ V}$ , $I_{PG} = 1.2\text{ mA}$	0.2	0.4		V

† CSR refers to the total series resistance, including the ESR of the capacitor, any series resistance added externally, and PWB trace resistance to  $C_O$ .

‡ Pulse-testing techniques are used to maintain virtual junction temperature as close as possible to ambient temperature; thermal effects must be taken into account separately.



TPS7101Q, TPS7133Q, TPS7148Q, TPS7150Q  
 TPS7101Y, TPS7133Y, TPS7148Y, TPS7150Y  
 LOW-DROPOUT VOLTAGE REGULATORS

SLVS092G – NOVEMBER 1994 – REVISED JANUARY 2003

electrical characteristics at  $I_O = 10\text{ mA}$ ,  $\overline{EN} = 0\text{ V}$ ,  $C_O = 4.7\text{ }\mu\text{F}/\text{CSR}^\dagger = 1\text{ }\Omega$ ,  $T_J = 25^\circ\text{C}$ , SENSE shorted to OUT (unless otherwise noted) (continued)

PARAMETER	TEST CONDITIONS <sup>‡</sup>		TPS7150Y			UNIT
			MIN	TYP	MAX	
Output voltage	$V_I = 6\text{ V}$ ,	$I_O = 10\text{ mA}$	5			V
Dropout voltage	$V_I = 4.88\text{ V}$ ,	$I_O = 10\text{ mA}$	0.13			mV
	$V_I = 4.88\text{ V}$ ,	$I_O = 100\text{ mA}$	27			
	$V_I = 4.88\text{ V}$ ,	$I_O = 500\text{ }\mu\text{A}$	146			
Pass-element series resistance	$(4.88\text{ V} - V_O)/I_O$ , $I_O = 500\text{ mA}$	$V_I = 4.88\text{ V}$ ,	0.29			$\Omega$
Output regulation	$6\text{ V} \leq V_I \leq 10\text{ V}$ ,	$I_O = 5\text{ mA to } 500\text{ mA}$	30			mV
	$6\text{ V} \leq V_I \leq 10\text{ V}$ ,	$I_O = 50\text{ }\mu\text{A to } 500\text{ mA}$	45			mV
Ripple rejection	$V_I = 6\text{ V}$ , $f = 120\text{ Hz}$	$I_O = 50\text{ }\mu\text{A}$	55			dB
		$I_O = 500\text{ mA}$	52			
Output noise-spectral density	$V_I = 6\text{ V}$ ,	$f = 120\text{ Hz}$	2			$\mu\text{V}/\sqrt{\text{Hz}}$
Output noise voltage	$V_I = 6\text{ V}$ , $10\text{ Hz} \leq f \leq 100\text{ kHz}$ , $\text{CSR}^\dagger = 1\text{ }\Omega$	$C_O = 4.7\text{ }\mu\text{F}$	430			$\mu\text{V}_{\text{rms}}$
		$C_O = 10\text{ }\mu\text{F}$	345			
		$C_O = 100\text{ }\mu\text{F}$	220			
PG hysteresis voltage	$V_I = 6\text{ V}$		53			mV
PG output low voltage	$V_I = 4.25\text{ V}$ ,	$P_G = 1.2\text{ mA}$	0.2			V

<sup>†</sup> CSR refers to the total series resistance, including the ESR of the capacitor, any series resistance added externally, and PWB trace resistance to  $C_O$ .

<sup>‡</sup> Pulse-testing techniques are used to maintain virtual junction temperature as close as possible to ambient temperature; thermal effects must be taken into account separately.

**TPS7101Q, TPS7133Q, TPS7148Q, TPS7150Q**  
**TPS7101Y, TPS7133Y, TPS7148Y, TPS7150Y**  
**LOW-DROPOUT VOLTAGE REGULATORS**

SLVS092G – NOVEMBER 1994 – REVISED JANUARY 2003

**TYPICAL CHARACTERISTICS**

**Table of Graphs**

		FIGURE	
$I_Q$	Quiescent current	vs Output current	5
		vs Input voltage	6
		vs Free-air temperature	7
$V_{DO}$	Dropout voltage	vs Output current	8
$\Delta V_{DO}$	Change in dropout voltage	vs Free-air temperature	9
$\Delta V_O$	Change in output voltage	vs Free-air temperature	10
$V_O$	Output voltage	vs Input voltage	11
$\Delta V_O$	Change in output voltage	vs Input voltage	12
$V_O$	Output voltage	vs Output current	13
			14
			15
			16
			17
	Ripple rejection	vs Frequency	18
			19
			20
			21
	Output spectral noise density	vs Frequency	22
			23
			24
			25
$r_{DS(on)}$	Pass-element resistance	vs Input voltage	25
R	Divider resistance	vs Free-air temperature	26
$I_I(SENSE)$	SENSE pin current	vs Free-air temperature	27
	FB leakage current	vs Free-air temperature	28
$V_I$	Minimum input voltage for active-pass element	vs Free-air temperature	29
	Minimum input voltage for valid PG	vs Free-air temperature	30
$I_I(EN)$	Input current ( $\overline{EN}$ )	vs Free-air temperature	31
	Output voltage response from Enable ( $\overline{EN}$ )		32
$V_{PG}$	Power-good (PG) voltage	vs Output voltage	33
CSR	Compensation series resistance	vs Output current	34
			35
CSR	Compensation series resistance	vs Added ceramic capacitance	36
			37
CSR	Compensation series resistance	vs Output current	38
			39
CSR	Compensation series resistance	vs Added ceramic capacitance	40
			41



TYPICAL CHARACTERISTICS

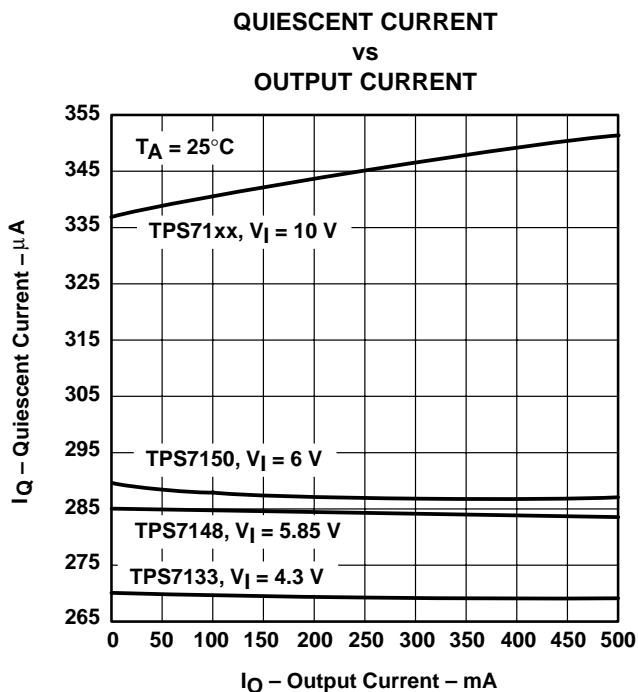

Figure 5

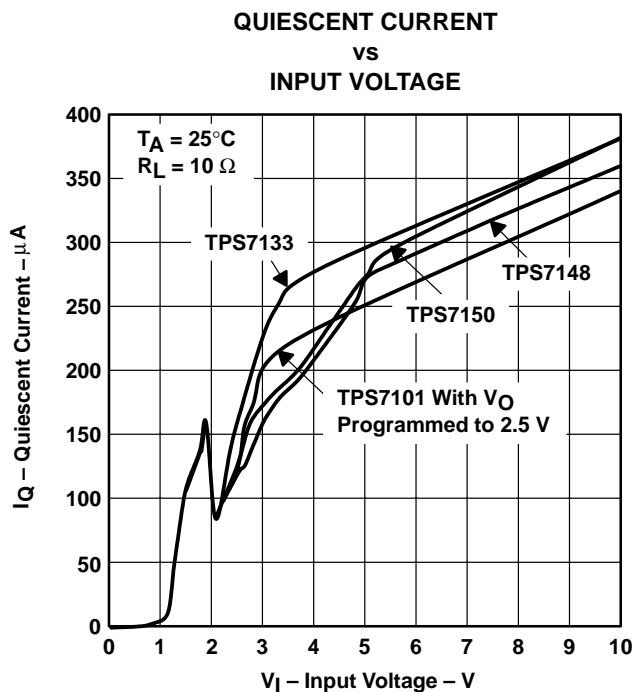

Figure 6

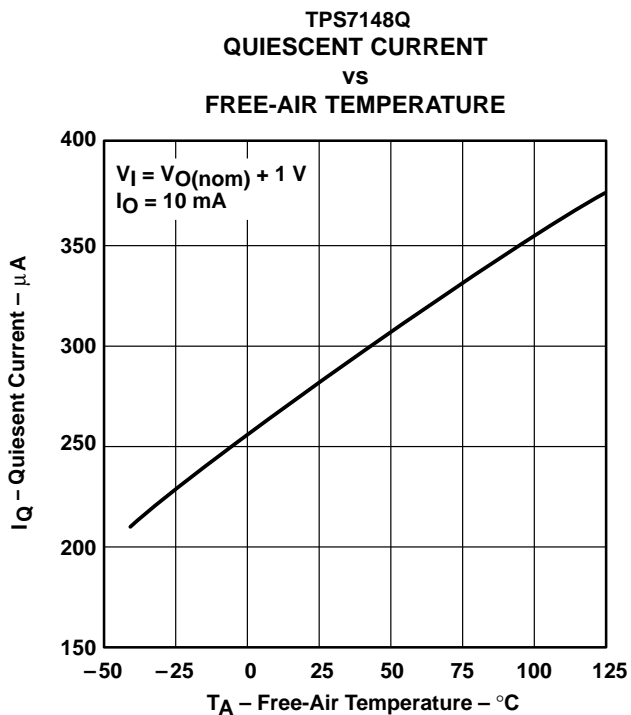

Figure 7

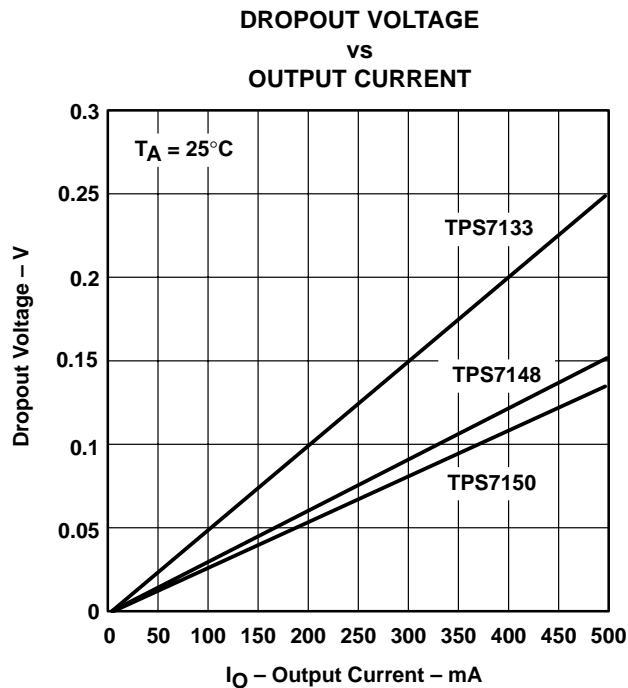

Figure 8

TYPICAL CHARACTERISTICS

CHANGE IN DROPOUT VOLTAGE  
 vs  
 FREE-AIR TEMPERATURE

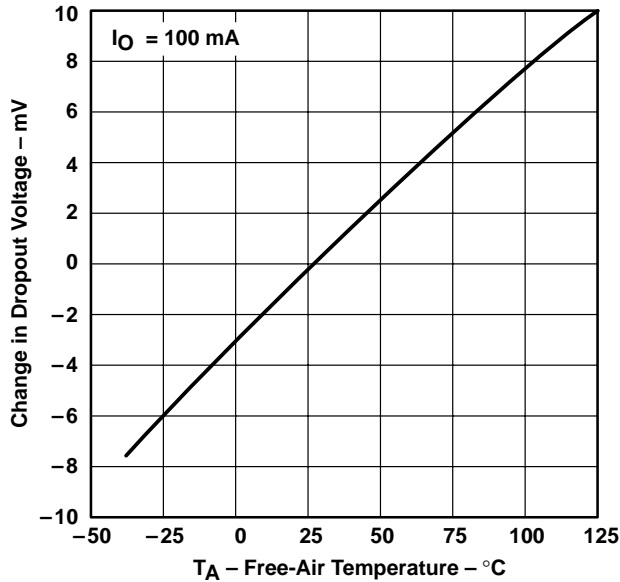

Figure 9

CHANGE IN OUTPUT VOLTAGE  
 vs  
 FREE-AIR TEMPERATURE

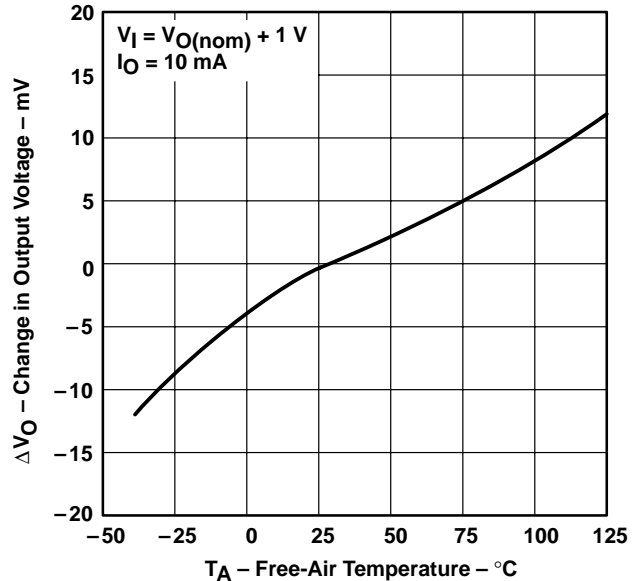

Figure 10

OUTPUT VOLTAGE  
 vs  
 INPUT VOLTAGE

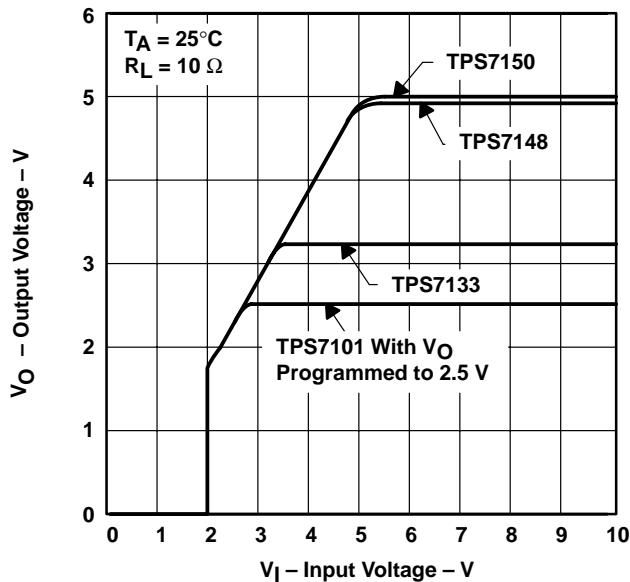

Figure 11

CHANGE IN OUTPUT VOLTAGE  
 vs  
 INPUT VOLTAGE

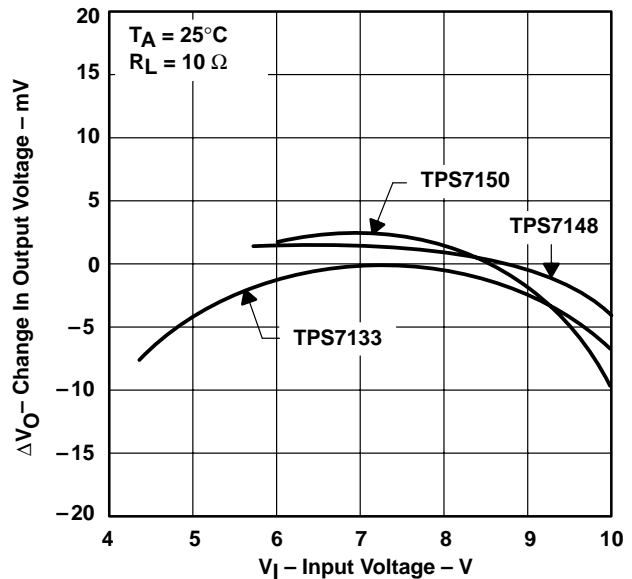
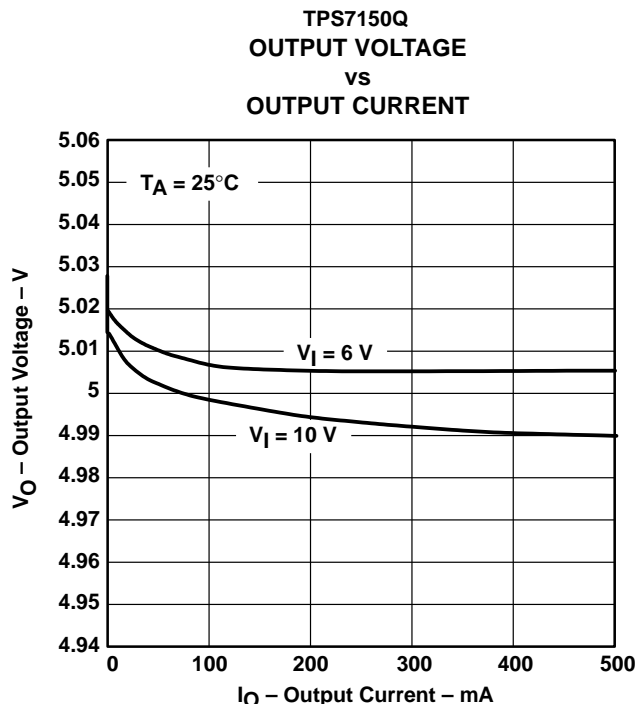
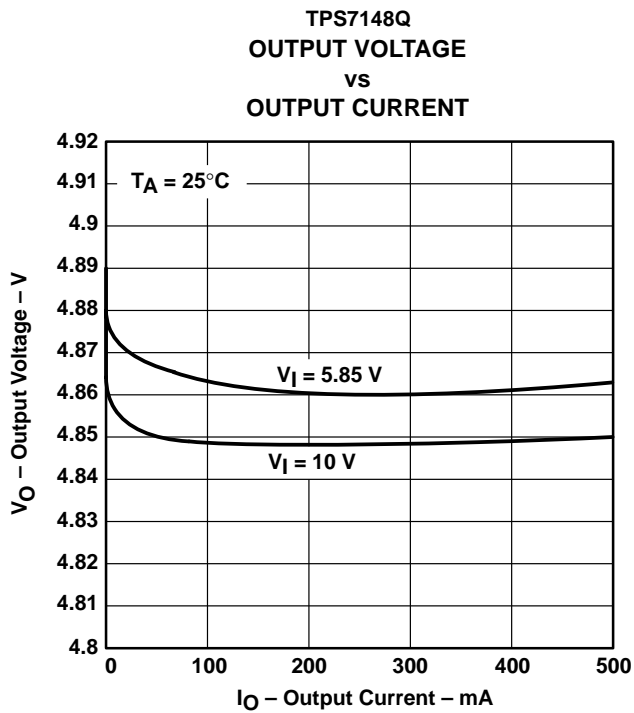
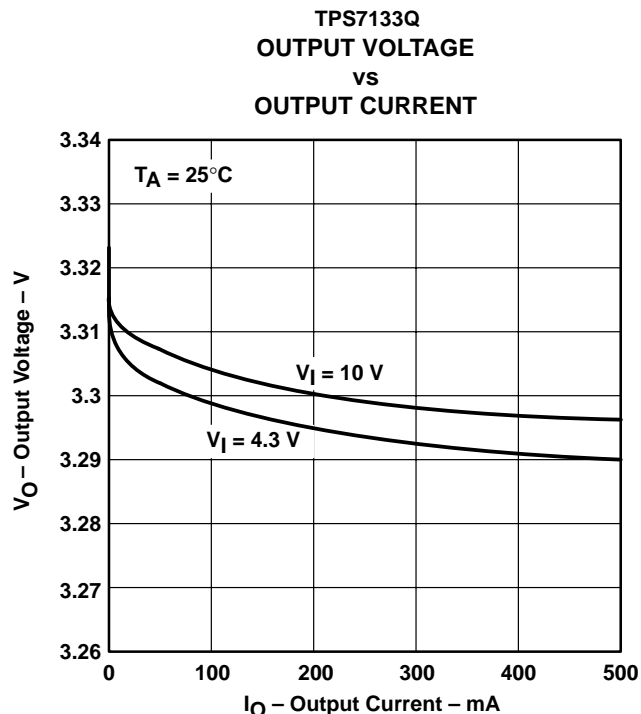
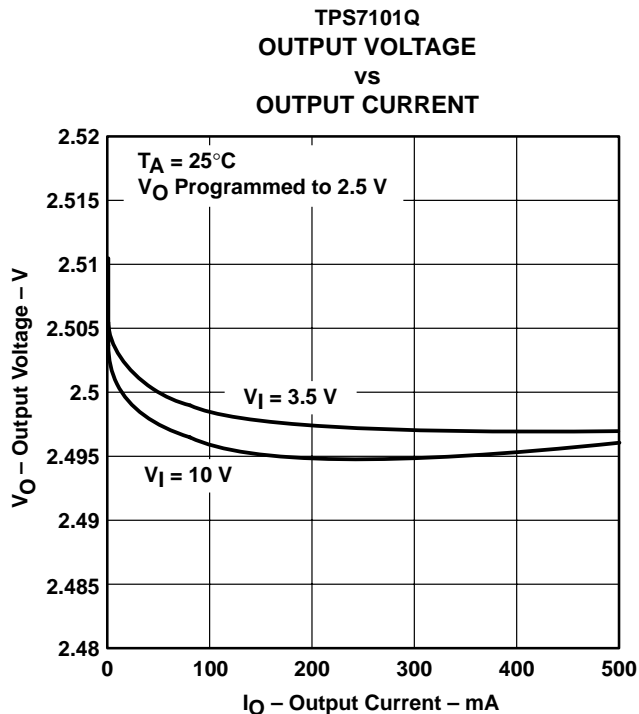

Figure 12

TYPICAL CHARACTERISTICS



TYPICAL CHARACTERISTICS

TPS7101Q  
 RIPPLE REJECTION  
 VS  
 FREQUENCY

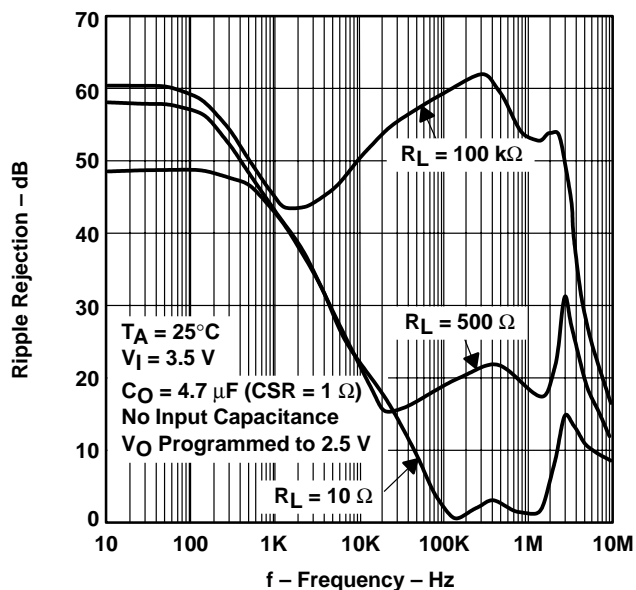

Figure 17

TPS7133Q  
 RIPPLE REJECTION  
 VS  
 FREQUENCY

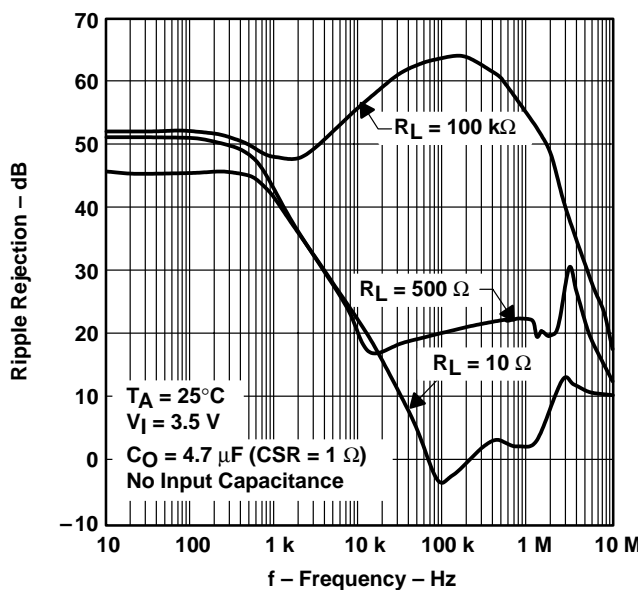

Figure 18

TPS7148Q  
 RIPPLE REJECTION  
 VS  
 FREQUENCY

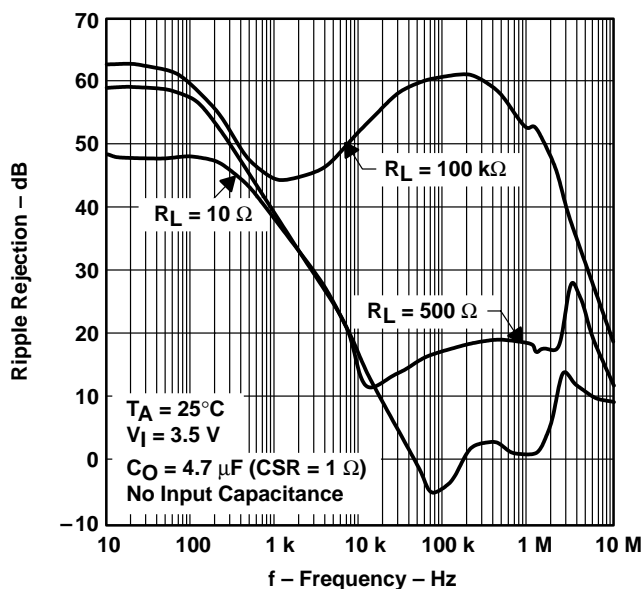

Figure 19

TPS7150Q  
 RIPPLE REJECTION  
 VS  
 FREQUENCY

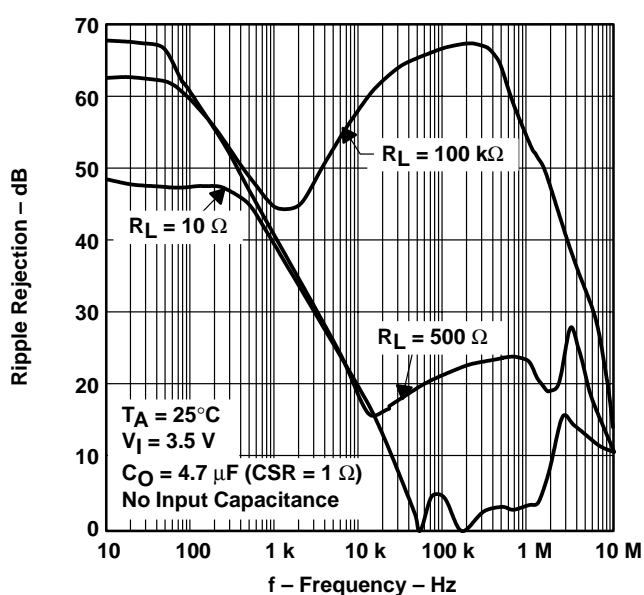

Figure 20

TYPICAL CHARACTERISTICS

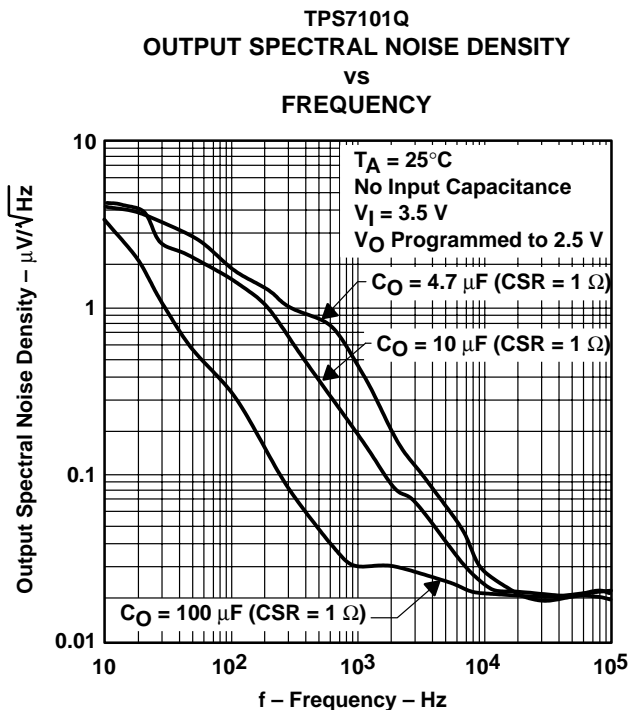

Figure 21

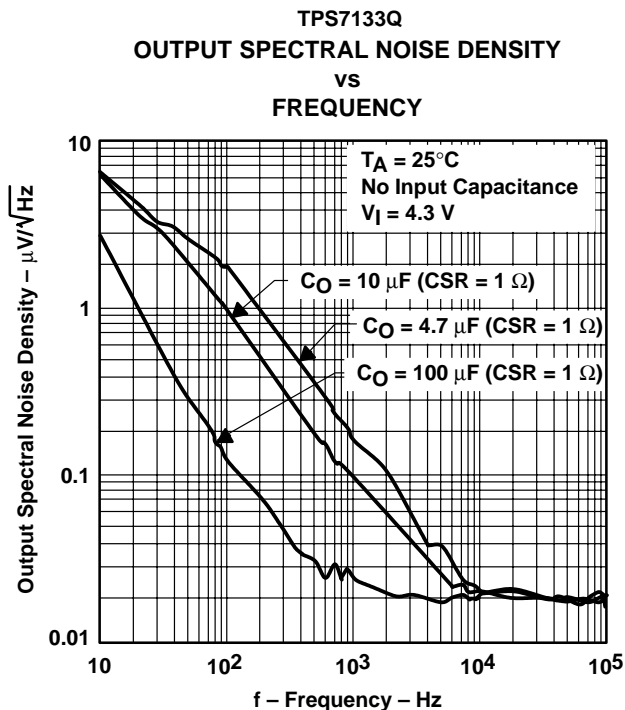

Figure 22

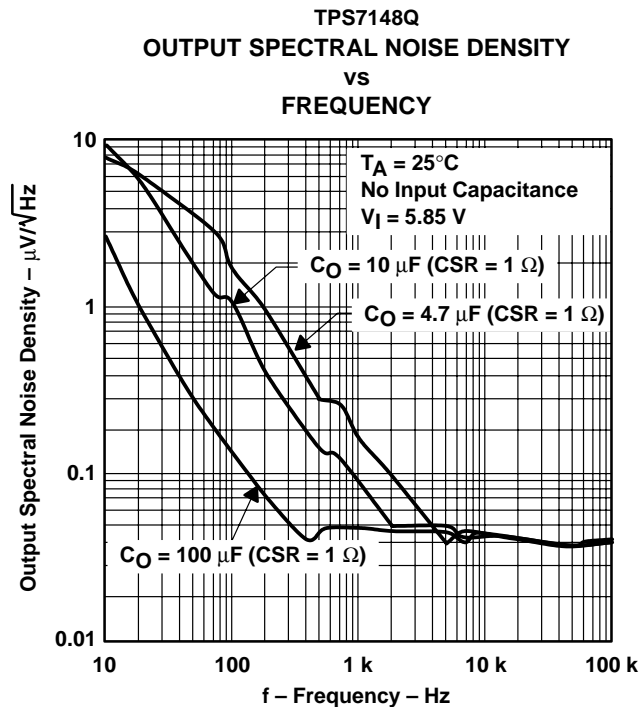

Figure 23

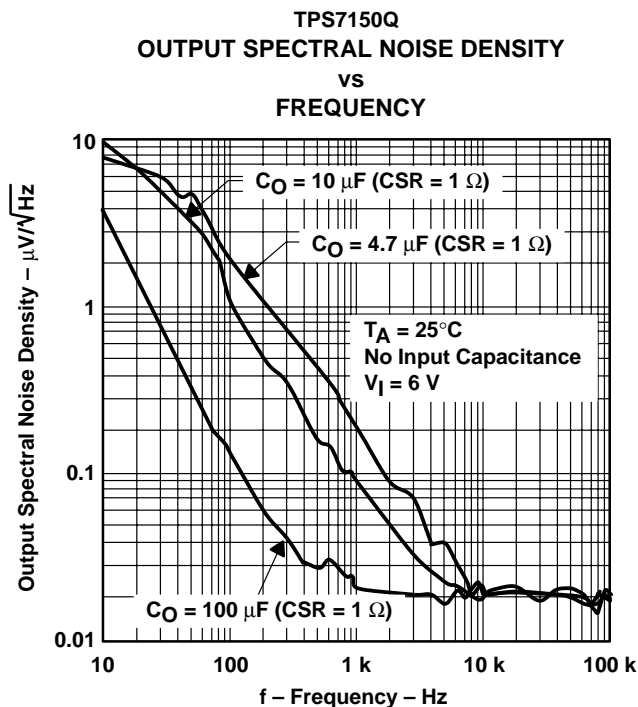

Figure 24

TYPICAL CHARACTERISTICS

PASS-ELEMENT RESISTANCE  
 vs  
 INPUT VOLTAGE

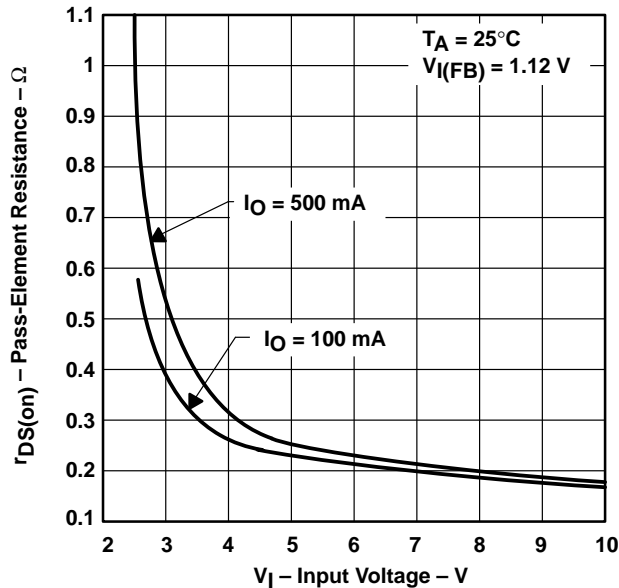

Figure 25

DIVIDER RESISTANCE  
 vs  
 FREE-AIR TEMPERATURE

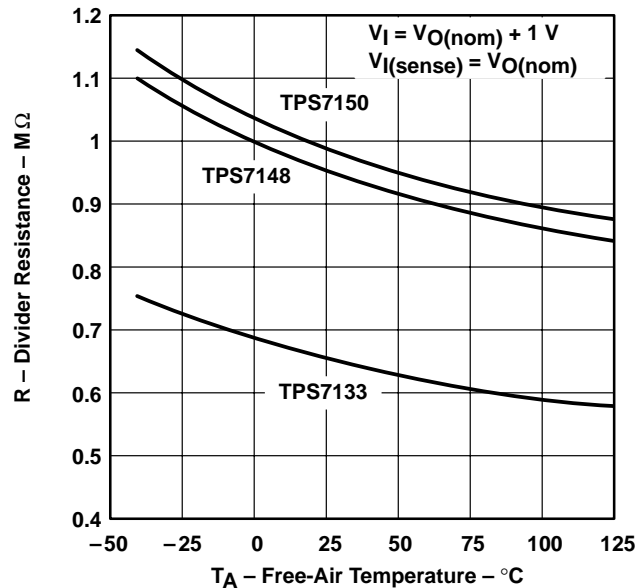

Figure 26

FIXED-OUTPUT VERSIONS  
 SENSE PIN CURRENT  
 vs  
 FREE-AIR TEMPERATURE

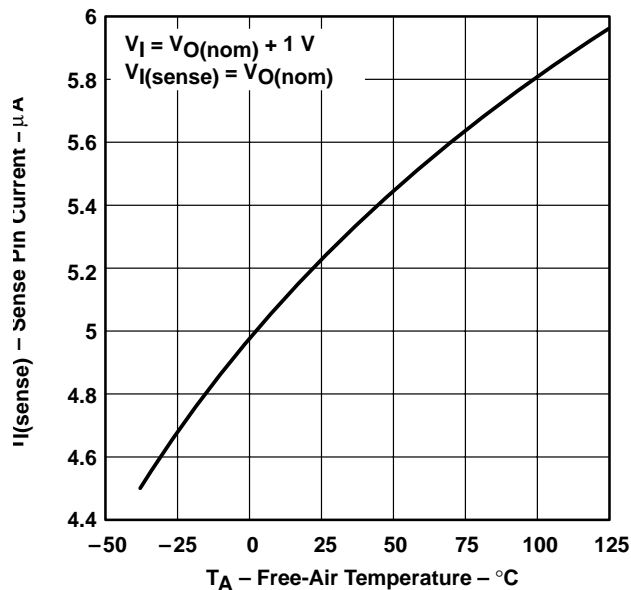

Figure 27

ADJUSTABLE VERSION  
 FB LEAKAGE CURRENT  
 vs  
 FREE-AIR TEMPERATURE

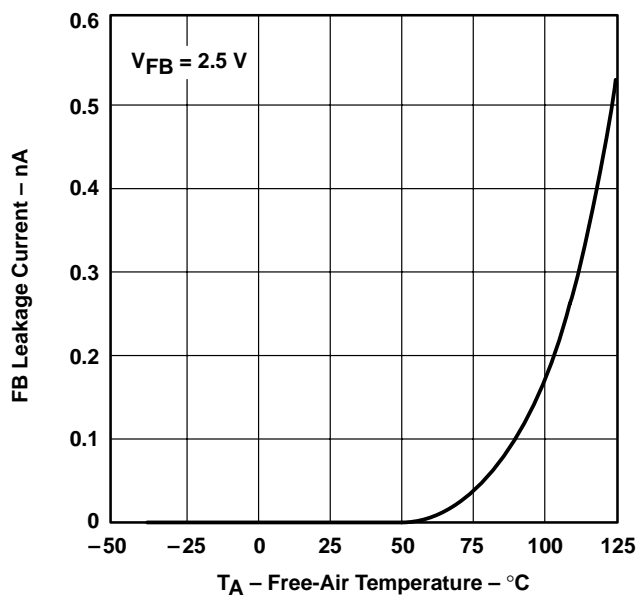

Figure 28

TYPICAL CHARACTERISTICS

MINIMUM INPUT VOLTAGE FOR ACTIVE  
 PASS ELEMENT  
 vs  
 FREE-AIR TEMPERATURE

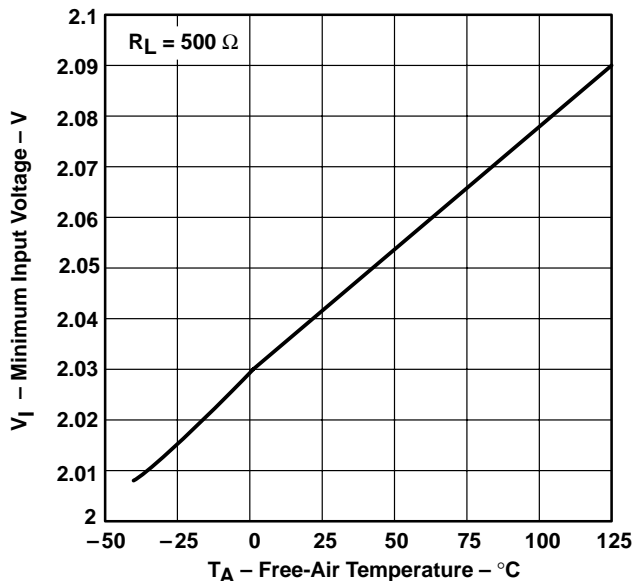

Figure 29

MINIMUM INPUT VOLTAGE FOR VALID  
 POWER GOOD (PG)  
 vs  
 FREE-AIR TEMPERATURE

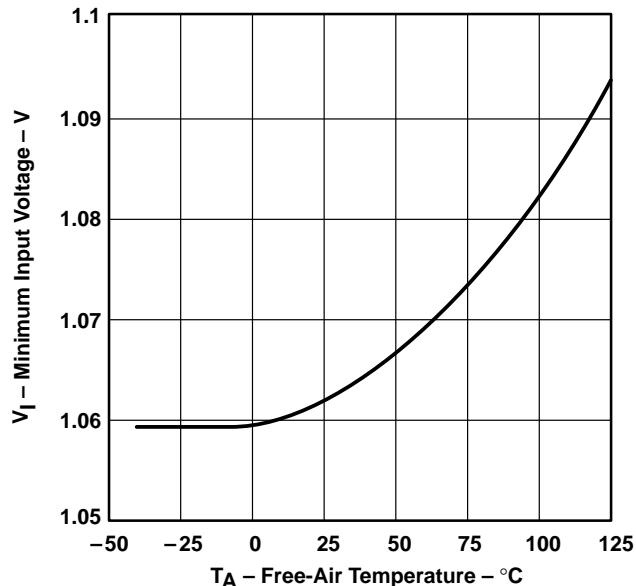

Figure 30

$\overline{\text{EN}}$  INPUT CURRENT  
 vs  
 FREE-AIR TEMPERATURE

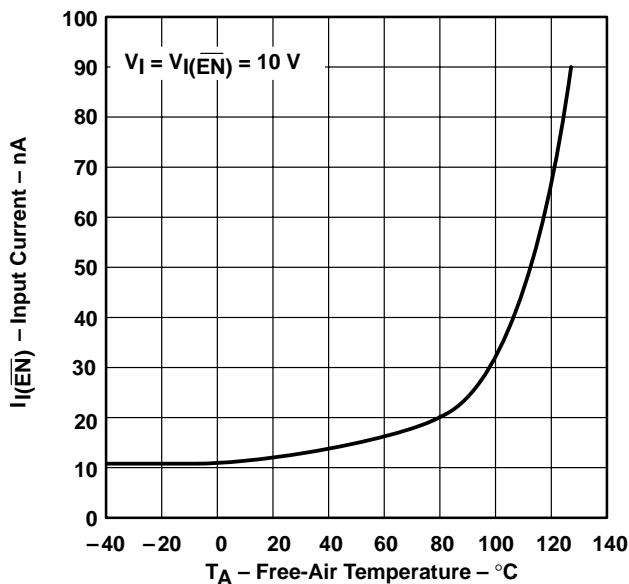

Figure 31

TYPICAL CHARACTERISTICS

OUTPUT VOLTAGE RESPONSE FROM  
 ENABLE ( $\overline{EN}$ )

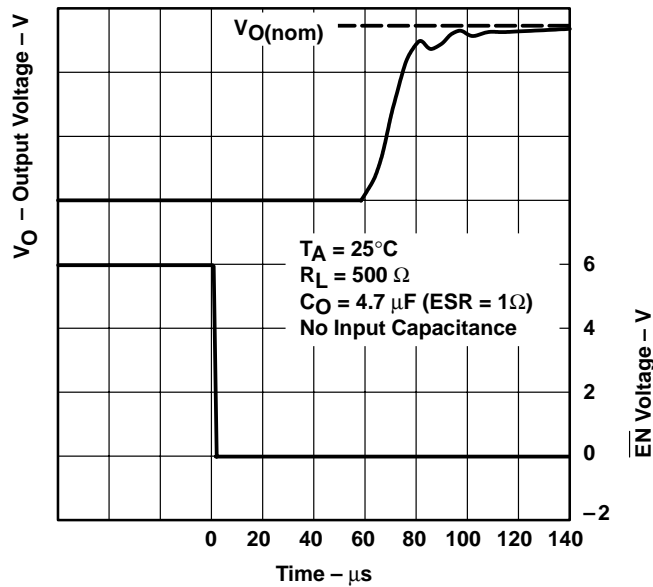

Figure 32

POWER-GOOD (PG) VOLTAGE  
 vs  
 OUTPUT VOLTAGE

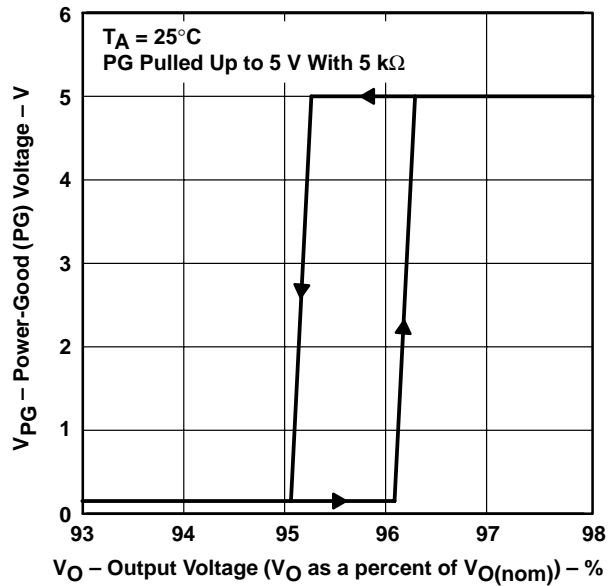

Figure 33

TYPICAL CHARACTERISTICS

TYPICAL REGIONS OF STABILITY  
 COMPENSATION SERIES RESISTANCE  
 vs  
 OUTPUT CURRENT

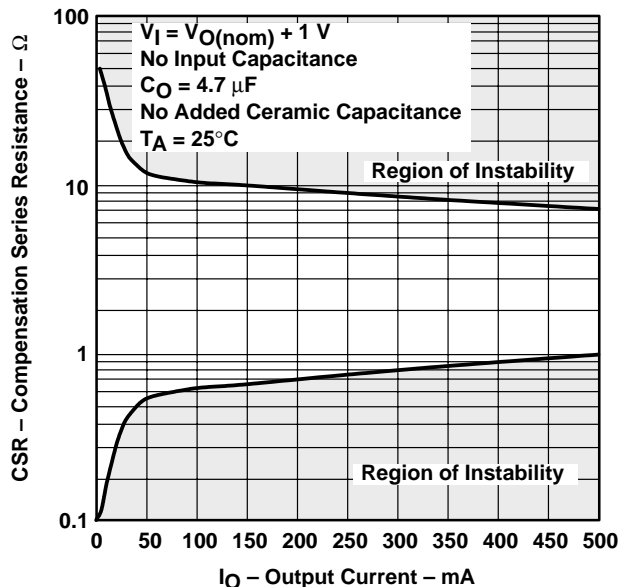

Figure 34

TYPICAL REGIONS OF STABILITY  
 COMPENSATION SERIES RESISTANCE  
 vs  
 OUTPUT CURRENT

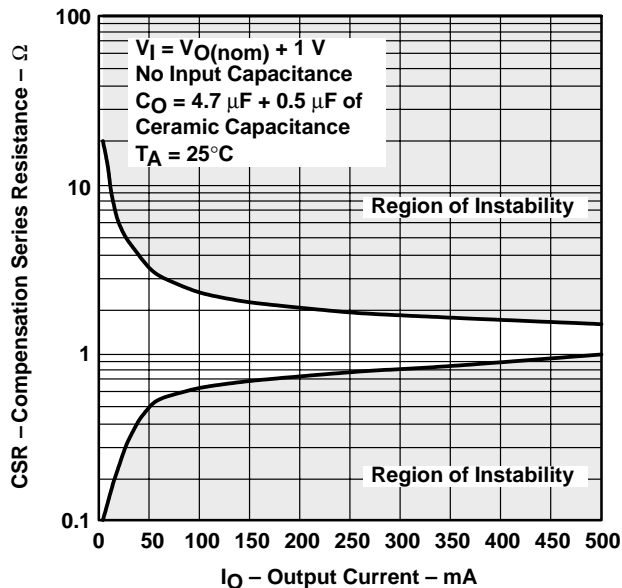

Figure 35

TYPICAL REGIONS OF STABILITY  
 COMPENSATION SERIES RESISTANCE  
 vs  
 ADDED CERAMIC CAPACITANCE

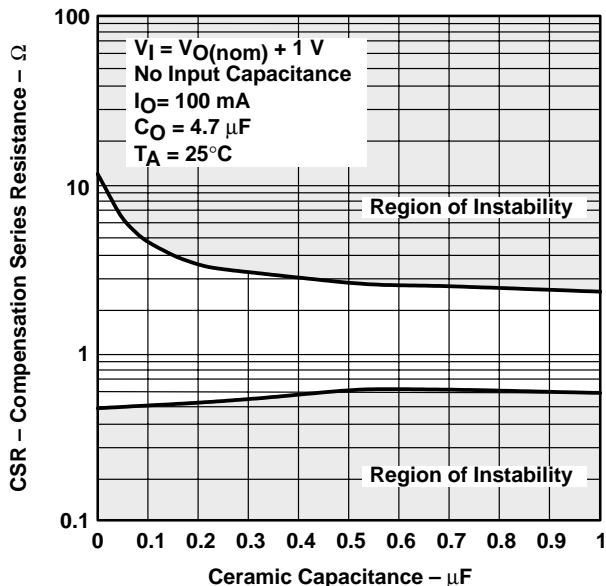

Figure 36

TYPICAL REGIONS OF STABILITY  
 COMPENSATION SERIES RESISTANCE  
 vs  
 ADDED CERAMIC CAPACITANCE

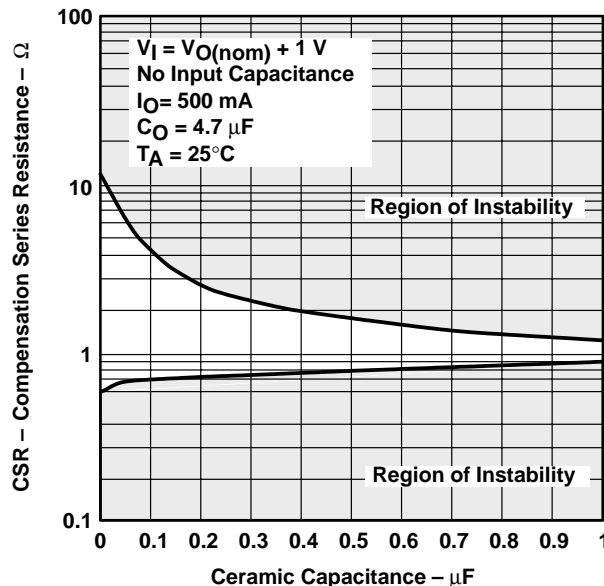

Figure 37

TYPICAL CHARACTERISTICS

TYPICAL REGIONS OF STABILITY†  
 COMPENSATION SERIES RESISTANCE  
 vs  
 OUTPUT CURRENT

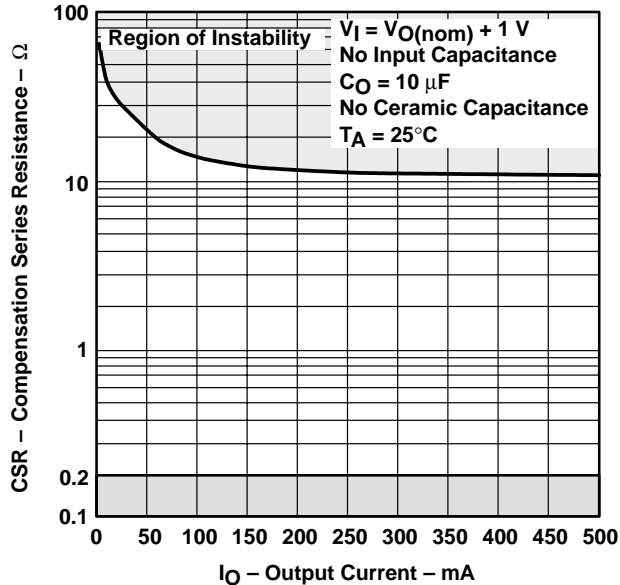

Figure 38

TYPICAL REGIONS OF STABILITY†  
 COMPENSATION SERIES RESISTANCE  
 vs  
 OUTPUT CURRENT

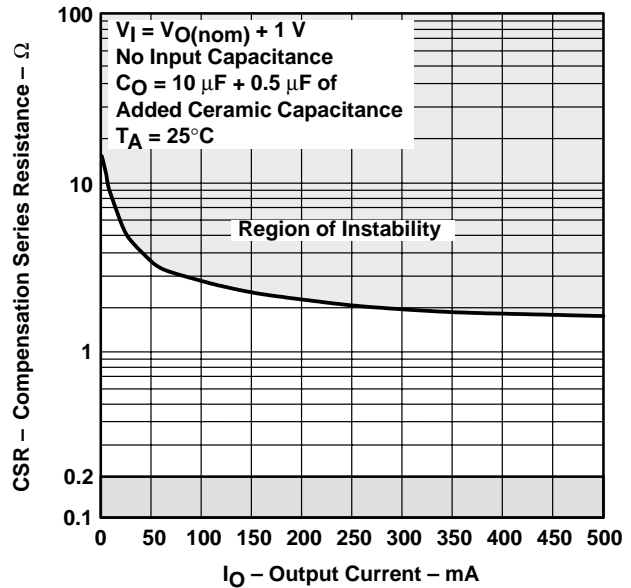

Figure 39

TYPICAL REGIONS OF STABILITY†  
 COMPENSATION SERIES RESISTANCE  
 vs  
 ADDED CERAMIC CAPACITANCE

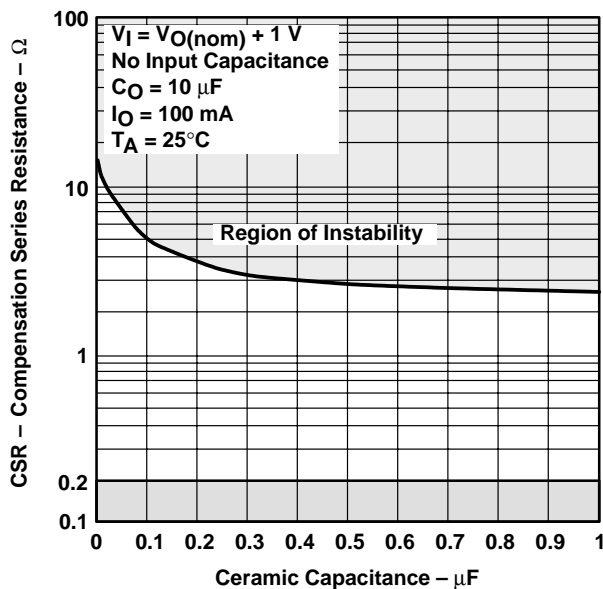

Figure 40

TYPICAL REGIONS OF STABILITY†  
 COMPENSATION SERIES RESISTANCE  
 vs  
 ADDED CERAMIC CAPACITANCE

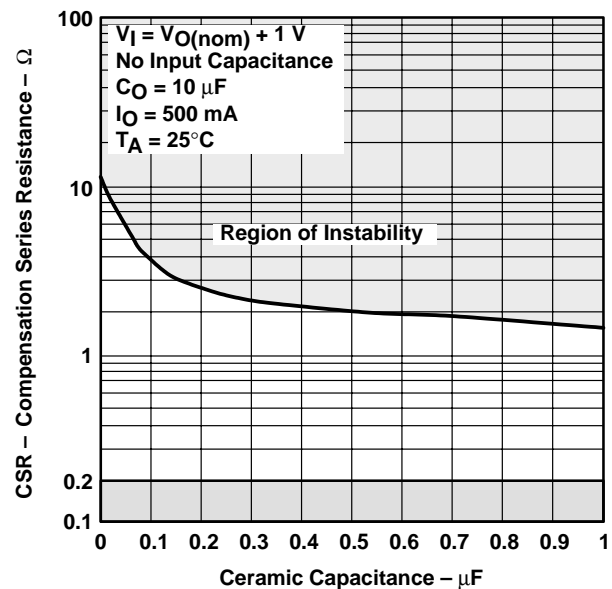
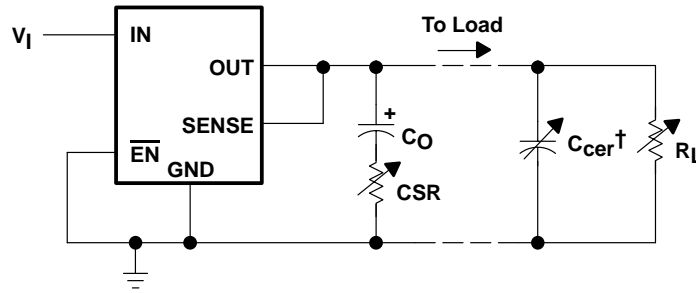

Figure 41

† CSR values below 0.1  $\Omega$  are not recommended.

TYPICAL CHARACTERISTICS



† Ceramic capacitor

Figure 42. Test Circuit for Typical Regions of Stability (Figures 34 through 41)

# TPS7101Q, TPS7133Q, TPS7148Q, TPS7150Q TPS7101Y, TPS7133Y, TPS7148Y, TPS7150Y LOW-DROPOUT VOLTAGE REGULATORS

SLVS092G – NOVEMBER 1994 – REVISED JANUARY 2003

---

## APPLICATION INFORMATION

The TPS71xx series of low-dropout (LDO) regulators is designed to overcome many of the shortcomings of earlier-generation LDOs, while adding features such as a power-saving shutdown mode and a power-good indicator. The TPS71xx family includes three fixed-output voltage regulators: the TPS7133 (3.3 V), the TPS7148 (4.85 V), and the TPS7150 (5 V). The family also offers an adjustable device, the TPS7101 (adjustable from 1.2 V to 9.75 V).

### device operation

The TPS71xx, unlike many other LDOs, features very low quiescent currents that remain virtually constant even with varying loads. Conventional LDO regulators use a pnp-pass element, the base current of which is directly proportional to the load current through the regulator ( $I_B = I_C/\beta$ ). Close examination of the data sheets reveals that those devices are typically specified under near no-load conditions; actual operating currents are much higher as evidenced by typical quiescent current versus load current curves. The TPS71xx uses a PMOS transistor to pass current; because the gate of the PMOS element is voltage driven, operating currents are low and invariable over the full load range. The TPS71xx specifications reflect actual performance under load.

Another pitfall associated with the pnp-pass element is its tendency to saturate when the device goes into dropout. The resulting drop in  $\beta$  forces an increase in  $I_B$  to maintain the load. During power up, this translates to large start-up currents. Systems with limited supply current may fail to start up. In battery-powered systems, it means rapid battery discharge when the voltage decays below the minimum required for regulation. The TPS71xx quiescent current remains low even when the regulator drops out, eliminating both problems.

Included in the TPS71xx family is a 4.85-V regulator, the TPS7148. Designed specifically for 5-V cellular systems, its 4.85-V output, regulated to within  $\pm 2\%$ , allows for operation within the low-end limit of 5-V systems specified to  $\pm 5\%$  tolerance; therefore, maximum regulated operating lifetime is obtained from a battery pack before the device drops out, adding crucial talk minutes between charges.

The TPS71xx family also features a shutdown mode that places the output in the high-impedance state (essentially equal to the feedback-divider resistance) and reduces quiescent current to under 2  $\mu\text{A}$ . If the shutdown feature is not used,  $\overline{\text{EN}}$  should be tied to ground. Response to an enable transition is quick; regulated output voltage is reestablished in typically 120  $\mu\text{s}$ .

### minimum load requirements

The TPS71xx family is stable even at zero load; no minimum load is required for operation.

### SENSE-pin connection

The SENSE pin of fixed-output devices must be connected to the regulator output for proper functioning of the regulator. Normally, this connection should be as short as possible; however, the connection can be made near a critical circuit (remote sense) to improve performance at that point. Internally, SENSE connects to a high-impedance wide-bandwidth amplifier through a resistor-divider network and noise pickup feeds through to the regulator output. Routing the SENSE connection to minimize/avoid noise pickup is essential. Adding an RC network between SENSE and OUT to filter noise is not recommended because it can cause the regulator to oscillate.

### external capacitor requirements

An input capacitor is not required; however, a ceramic bypass capacitor (0.047 pF to 0.1  $\mu\text{F}$ ) improves load transient response and noise rejection if the TPS71xx is located more than a few inches from the power supply. A higher-capacitance electrolytic capacitor may be necessary if large (hundreds of milliamps) load transients with fast rise times are anticipated.



## APPLICATION INFORMATION

### external capacitor requirements (continued)

As with most LDO regulators, the TPS71xx family requires an output capacitor for stability. A 10- $\mu\text{F}$  solid-tantalum capacitor connected from the regulator output to ground is sufficient to ensure stability over the full load range (see Figure 43). Adding high-frequency ceramic or film capacitors (such as power-supply bypass capacitors for digital or analog ICs) can cause the regulator to become unstable unless the ESR of the tantalum capacitor is less than 1.2  $\Omega$  over temperature. Where component height and/or mounting area is a problem, physically smaller, 10- $\mu\text{F}$  devices can be screened for ESR. Figures 34 through 41 show the stable regions of operation using different values of output capacitance with various values of ceramic load capacitance.

In applications with little or no high-frequency bypass capacitance (< 0.2  $\mu\text{F}$ ), the output capacitance can be reduced to 4.7  $\mu\text{F}$ , provided ESR is maintained between the values shown in figures 34 through 41. Because minimum capacitor ESR is seldom if ever specified, it may be necessary to add a 0.5- $\Omega$  to 1- $\Omega$  resistor in series with the capacitor and limit ESR to 1.5  $\Omega$  maximum.

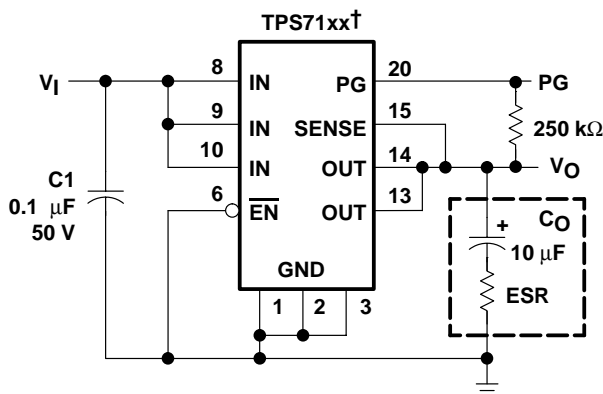

† TPS7133, TPS7148, TPS7150 (fixed-voltage options)

Figure 43. Typical Application Circuit

### programming the TPS7101 adjustable LDO regulator

Programming the adjustable regulators is accomplished using an external resistor divider as shown in Figure 44. The equation governing the output voltage is:

$$V_O = V_{\text{ref}} \cdot \left(1 + \frac{R1}{R2}\right)$$

where

$V_{\text{ref}}$  = reference voltage, 1.178 V typ

**TPS7101Q, TPS7133Q, TPS7148Q, TPS7150Q  
 TPS7101Y, TPS7133Y, TPS7148Y, TPS7150Y  
 LOW-DROPOUT VOLTAGE REGULATORS**

SLVS092G – NOVEMBER 1994 – REVISED JANUARY 2003

**APPLICATION INFORMATION**

**programming the TPS7101 adjustable LDO regulator (continued)**

Resistors R1 and R2 should be chosen for approximately 7-μA divider current. A recommended value for R2 is 169 kΩ with R1 adjusted for the desired output voltage. Smaller resistors can be used, but offer no inherent advantage and consume more power. Larger values of R1 and R2 should be avoided as leakage currents at FB introduce an error. Solving equation 1 for R1 yields a more useful equation for choosing the appropriate resistance:

$$R1 = \left( \frac{V_O}{V_{ref}} - 1 \right) \cdot R2$$

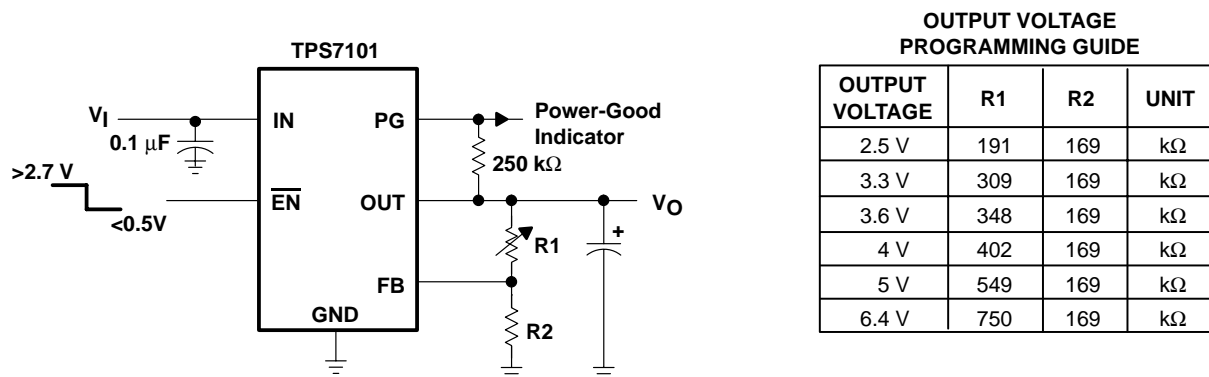

**Figure 44. TPS7101 Adjustable LDO Regulator Programming**

**power-good indicator**

The TPS71xx features a power-good (PG) output that can be used to monitor the status of the regulator. The internal comparator monitors the output voltage: when the output drops to between 92% and 98% of its nominal regulated value, the PG output transistor turns on, taking the signal low. The open-drain output requires a pullup resistor. If not used, it can be left floating. PG can be used to drive power-on reset circuitry or as a low-battery indicator. PG does not assert itself when the regulated output voltage falls outside the specified 2% tolerance, but instead reports an output voltage low, relative to its nominal regulated value.

**regulator protection**

The TPS71xx PMOS-pass transistor has a built-in back diode that safely conducts reverse currents when the input voltage drops below the output voltage (e.g., during power down). Current is conducted from the output to the input and is not internally limited. When extended reverse voltage is anticipated, external limiting may be appropriate.

The TPS71xx also features internal current limiting and thermal protection. During normal operation, the TPS71xx limits output current to approximately 1 A. When current limiting engages, the output voltage scales back linearly until the overcurrent condition ends. While current limiting is designed to prevent gross device failure, care should be taken not to exceed the power dissipation ratings of the package. If the temperature of the device exceeds 165°C, thermal-protection circuitry shuts it down. Once the device has cooled, regulator operation resumes.



TPS7101Q, TPS7133Q, TPS7148Q, TPS7150Q  
 TPS7101Y, TPS7133Y, TPS7148Y, TPS7150Y  
**LOW-DROPOUT VOLTAGE REGULATORS**

SLVS092G – NOVEMBER 1994 – REVISED JANUARY 2003

**MECHANICAL DATA**

**D (R-PDSO-G\*\*)**

**PLASTIC SMALL-OUTLINE PACKAGE**

14 PIN SHOWN

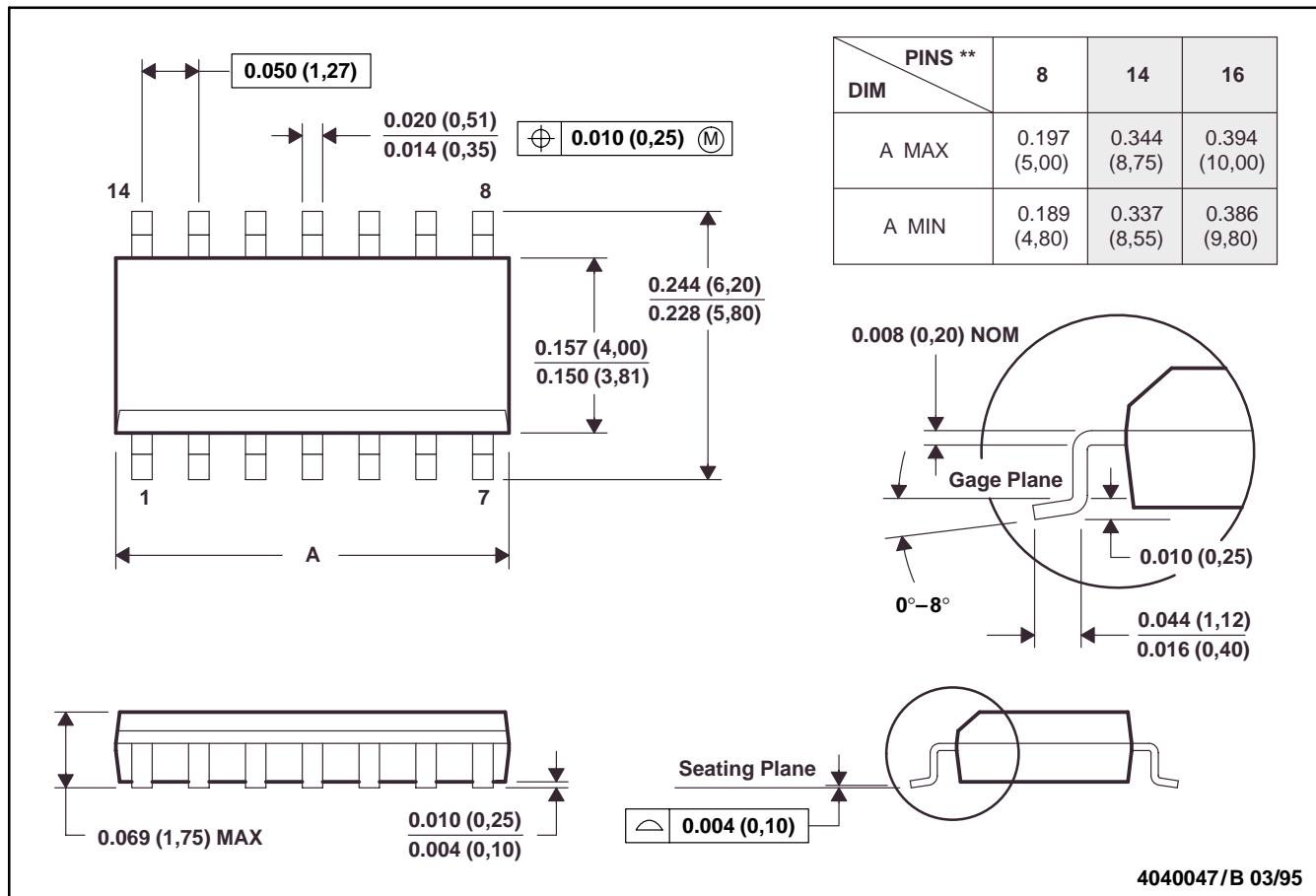

- NOTES: B. All linear dimensions are in inches (millimeters).  
 C. This drawing is subject to change without notice.  
 D. Body dimensions do not include mold flash or protrusion, not to exceed 0.006 (0,15).  
 E. Four center pins are connected to die mount pad.  
 F. Falls within JEDEC MS-012

**TPS7101Q, TPS7133Q, TPS7148Q, TPS7150Q**  
**TPS7101Y, TPS7133Y, TPS7148Y, TPS7150Y**  
**LOW-DROPOUT VOLTAGE REGULATORS**

SLVS092G – NOVEMBER 1994 – REVISED JANUARY 2003

**MECHANICAL DATA**

**P (R-PDIP-T8)**

**PLASTIC DUAL-IN-LINE PACKAGE**

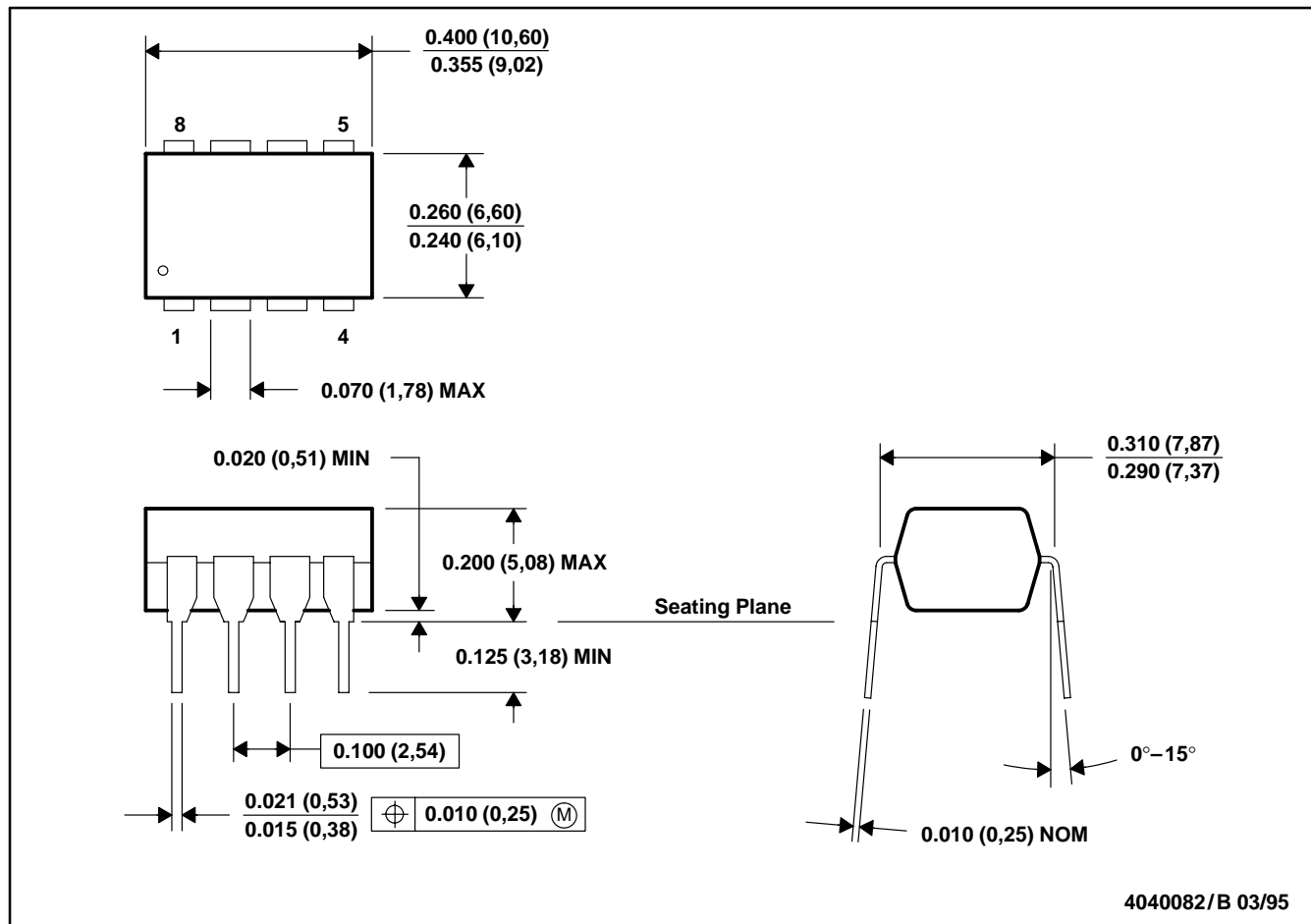

- NOTES: A. All linear dimensions are in inches (millimeters).  
 B. This drawing is subject to change without notice.  
 C. Falls within JEDEC MS-001

TPS7101Q, TPS7133Q, TPS7148Q, TPS7150Q  
 TPS7101Y, TPS7133Y, TPS7148Y, TPS7150Y  
**LOW-DROPOUT VOLTAGE REGULATORS**

SLVS092G – NOVEMBER 1994 – REVISED JANUARY 2003

**MECHANICAL DATA**

**PW (R-PDSO-G\*\*)**

**PLASTIC SMALL-OUTLINE PACKAGE**

14 PIN SHOWN

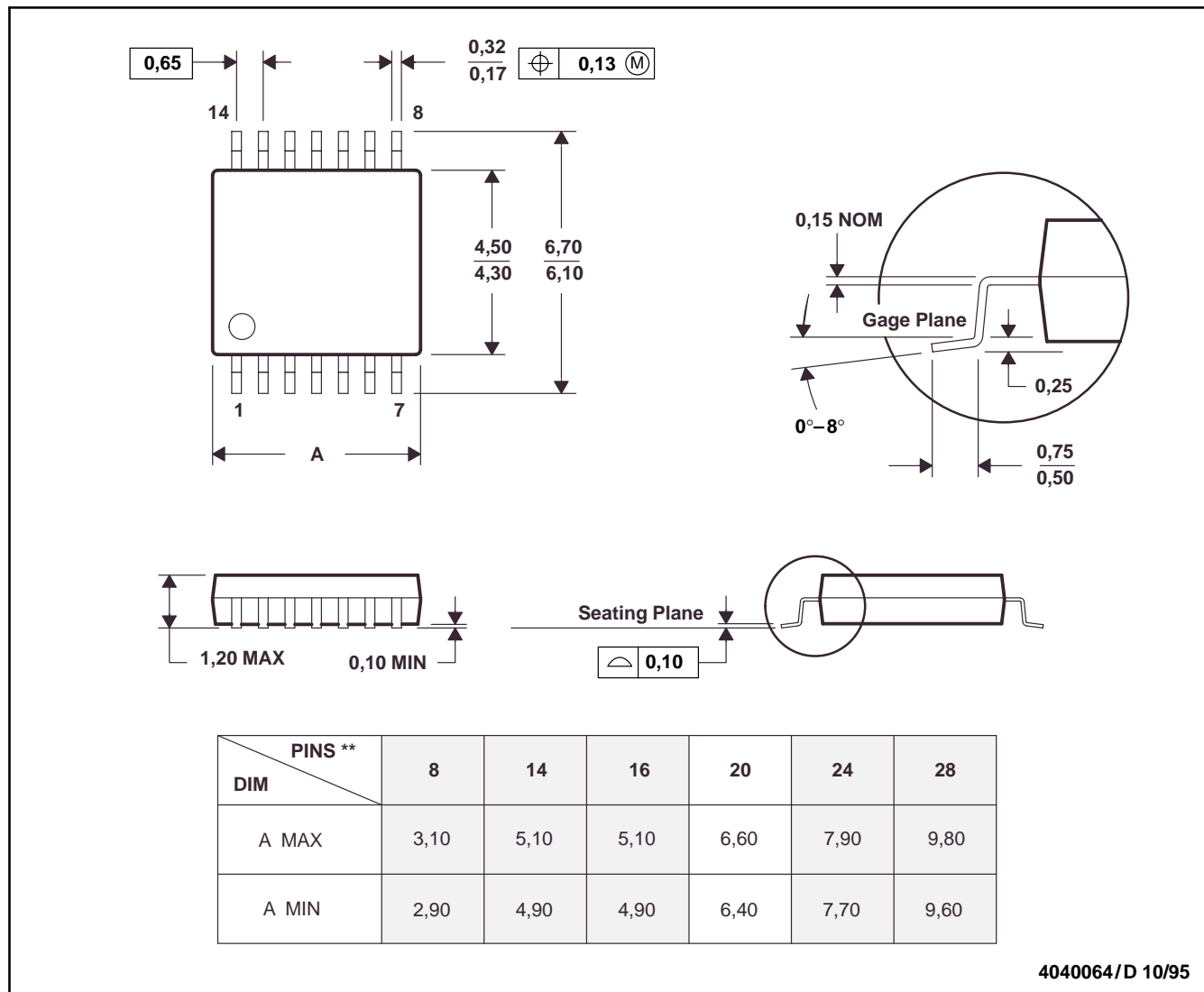

- NOTES: A. All linear dimensions are in millimeters.  
 B. This drawing is subject to change without notice.  
 C. Body dimensions do not include mold flash or protrusion not to exceed 0,15.  
 D. Falls within JEDEC MO-153

**PACKAGING INFORMATION**

Orderable Device	Status <sup>(1)</sup>	Package Type	Package Drawing	Pins	Package Qty	Eco Plan <sup>(2)</sup>	Lead/Ball Finish	MSL Peak Temp <sup>(3)</sup>
TPS7101QD	ACTIVE	SOIC	D	8	75	TBD	CU NIPDAU	Level-1-220C-UNLIM
TPS7101QDR	ACTIVE	SOIC	D	8	2500	TBD	CU NIPDAU	Level-1-220C-UNLIM
TPS7101QP	ACTIVE	PDIP	P	8	50	Pb-Free (RoHS)	CU NIPDAU	Level-NC-NC-NC
TPS7101QPE4	ACTIVE	PDIP	P	8	50	Pb-Free (RoHS)	CU NIPDAU	Level-NC-NC-NC
TPS7101QPW	ACTIVE	TSSOP	PW	20	70	TBD	CU NIPDAU	Level-1-220C-UNLIM
TPS7101QPWLE	OBSOLETE	TSSOP	PW	20		TBD	Call TI	Call TI
TPS7101QPWR	ACTIVE	TSSOP	PW	20	2000	TBD	CU NIPDAU	Level-1-220C-UNLIM
TPS7133QD	ACTIVE	SOIC	D	8	75	Pb-Free (RoHS)	CU NIPDAU	Level-2-260C-1YEAR/ Level-1-220C-UNLIM
TPS7133QDG4	ACTIVE	SOIC	D	8	75	Pb-Free (RoHS)	CU NIPDAU	Level-2-260C-1YEAR/ Level-1-220C-UNLIM
TPS7133QDR	ACTIVE	SOIC	D	8	2500	Pb-Free (RoHS)	CU NIPDAU	Level-2-260C-1YEAR/ Level-1-220C-UNLIM
TPS7133QDRG4	ACTIVE	SOIC	D	8	2500	Pb-Free (RoHS)	CU NIPDAU	Level-2-260C-1YEAR/ Level-1-220C-UNLIM
TPS7133QP	ACTIVE	PDIP	P	8	50	Pb-Free (RoHS)	CU NIPDAU	Level-NC-NC-NC
TPS7133QPE4	ACTIVE	PDIP	P	8	50	Pb-Free (RoHS)	CU NIPDAU	Level-NC-NC-NC
TPS7133QPW	ACTIVE	TSSOP	PW	20	70	TBD	CU NIPDAU	Level-1-220C-UNLIM
TPS7133QPWLE	OBSOLETE	TSSOP	PW	20		TBD	Call TI	Call TI
TPS7133QPWPLE	OBSOLETE	TSSOP	PW	20		TBD	Call TI	Call TI
TPS7133QPWR	ACTIVE	TSSOP	PW	20	2000	TBD	CU NIPDAU	Level-1-220C-UNLIM
TPS7148QD	ACTIVE	SOIC	D	8	75	Pb-Free (RoHS)	CU NIPDAU	Level-2-260C-1YEAR/ Level-1-220C-UNLIM
TPS7148QDR	ACTIVE	SOIC	D	8	2500	Pb-Free (RoHS)	CU NIPDAU	Level-2-260C-1YEAR/ Level-1-220C-UNLIM
TPS7148QP	ACTIVE	PDIP	P	8	50	Pb-Free (RoHS)	CU NIPDAU	Level-NC-NC-NC
TPS7148QPE4	ACTIVE	PDIP	P	8	50	Pb-Free (RoHS)	CU NIPDAU	Level-NC-NC-NC
TPS7148QPWLE	OBSOLETE	TSSOP	PW	20		TBD	Call TI	Call TI
TPS7148QPWR	ACTIVE	TSSOP	PW	20	2000	TBD	CU NIPDAU	Level-1-220C-UNLIM
TPS7150QD	ACTIVE	SOIC	D	8	75	Pb-Free (RoHS)	CU NIPDAU	Level-2-260C-1YEAR/ Level-1-220C-UNLIM
TPS7150QDR	ACTIVE	SOIC	D	8	2500	Pb-Free (RoHS)	CU NIPDAU	Level-2-260C-1YEAR/ Level-1-220C-UNLIM
TPS7150QP	ACTIVE	PDIP	P	8	50	Pb-Free (RoHS)	CU NIPDAU	Level-NC-NC-NC
TPS7150QPE4	ACTIVE	PDIP	P	8	50	Pb-Free (RoHS)	CU NIPDAU	Level-NC-NC-NC
TPS7150QPW	ACTIVE	TSSOP	PW	20	70	TBD	CU NIPDAU	Level-1-220C-UNLIM
TPS7150QPWLE	OBSOLETE	TSSOP	PW	20		TBD	Call TI	Call TI
TPS7150QPWR	ACTIVE	TSSOP	PW	20	2000	TBD	CU NIPDAU	Level-1-220C-UNLIM

(1) The marketing status values are defined as follows:

**ACTIVE:** Product device recommended for new designs.

**LIFEBUY:** TI has announced that the device will be discontinued, and a lifetime-buy period is in effect.

**NRND:** Not recommended for new designs. Device is in production to support existing customers, but TI does not recommend using this part in a new design.

**PREVIEW:** Device has been announced but is not in production. Samples may or may not be available.

**OBSOLETE:** TI has discontinued the production of the device.

(2) Eco Plan - The planned eco-friendly classification: Pb-Free (RoHS) or Green (RoHS & no Sb/Br) - please check <http://www.ti.com/productcontent> for the latest availability information and additional product content details.

**TBD:** The Pb-Free/Green conversion plan has not been defined.

**Pb-Free (RoHS):** TI's terms "Lead-Free" or "Pb-Free" mean semiconductor products that are compatible with the current RoHS requirements for all 6 substances, including the requirement that lead not exceed 0.1% by weight in homogeneous materials. Where designed to be soldered at high temperatures, TI Pb-Free products are suitable for use in specified lead-free processes.

**Green (RoHS & no Sb/Br):** TI defines "Green" to mean Pb-Free (RoHS compatible), and free of Bromine (Br) and Antimony (Sb) based flame retardants (Br or Sb do not exceed 0.1% by weight in homogeneous material)

(3) MSL, Peak Temp. -- The Moisture Sensitivity Level rating according to the JEDEC industry standard classifications, and peak solder temperature.

**Important Information and Disclaimer:**The information provided on this page represents TI's knowledge and belief as of the date that it is provided. TI bases its knowledge and belief on information provided by third parties, and makes no representation or warranty as to the accuracy of such information. Efforts are underway to better integrate information from third parties. TI has taken and continues to take reasonable steps to provide representative and accurate information but may not have conducted destructive testing or chemical analysis on incoming materials and chemicals. TI and TI suppliers consider certain information to be proprietary, and thus CAS numbers and other limited information may not be available for release.

In no event shall TI's liability arising out of such information exceed the total purchase price of the TI part(s) at issue in this document sold by TI to Customer on an annual basis.

P (R-PDIP-T8)

PLASTIC DUAL-IN-LINE

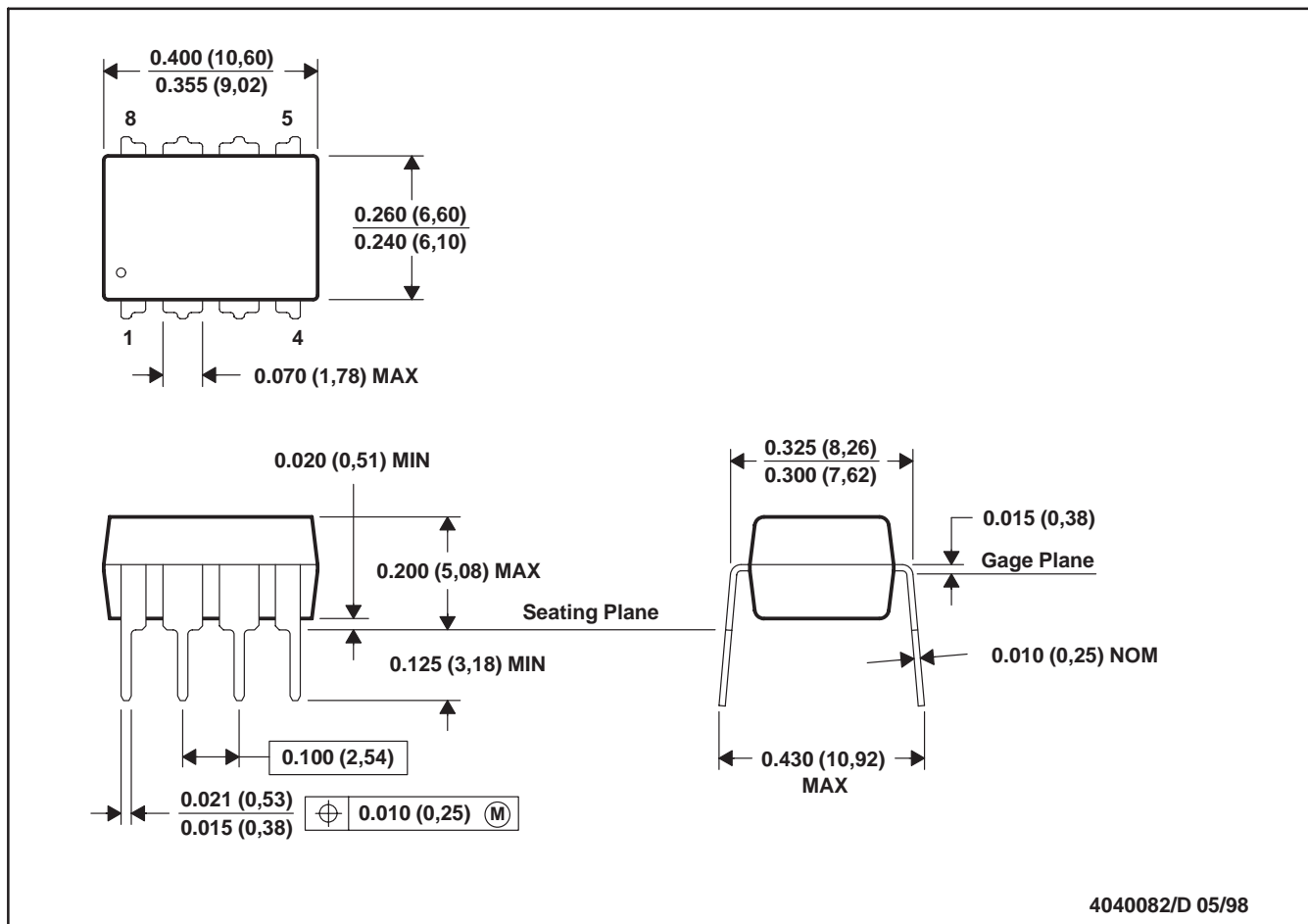

- NOTES: A. All linear dimensions are in inches (millimeters).  
 B. This drawing is subject to change without notice.  
 C. Falls within JEDEC MS-001

For the latest package information, go to [http://www.ti.com/sc/docs/package/pkg\\_info.htm](http://www.ti.com/sc/docs/package/pkg_info.htm)

D (R-PDSO-G8)

PLASTIC SMALL-OUTLINE PACKAGE

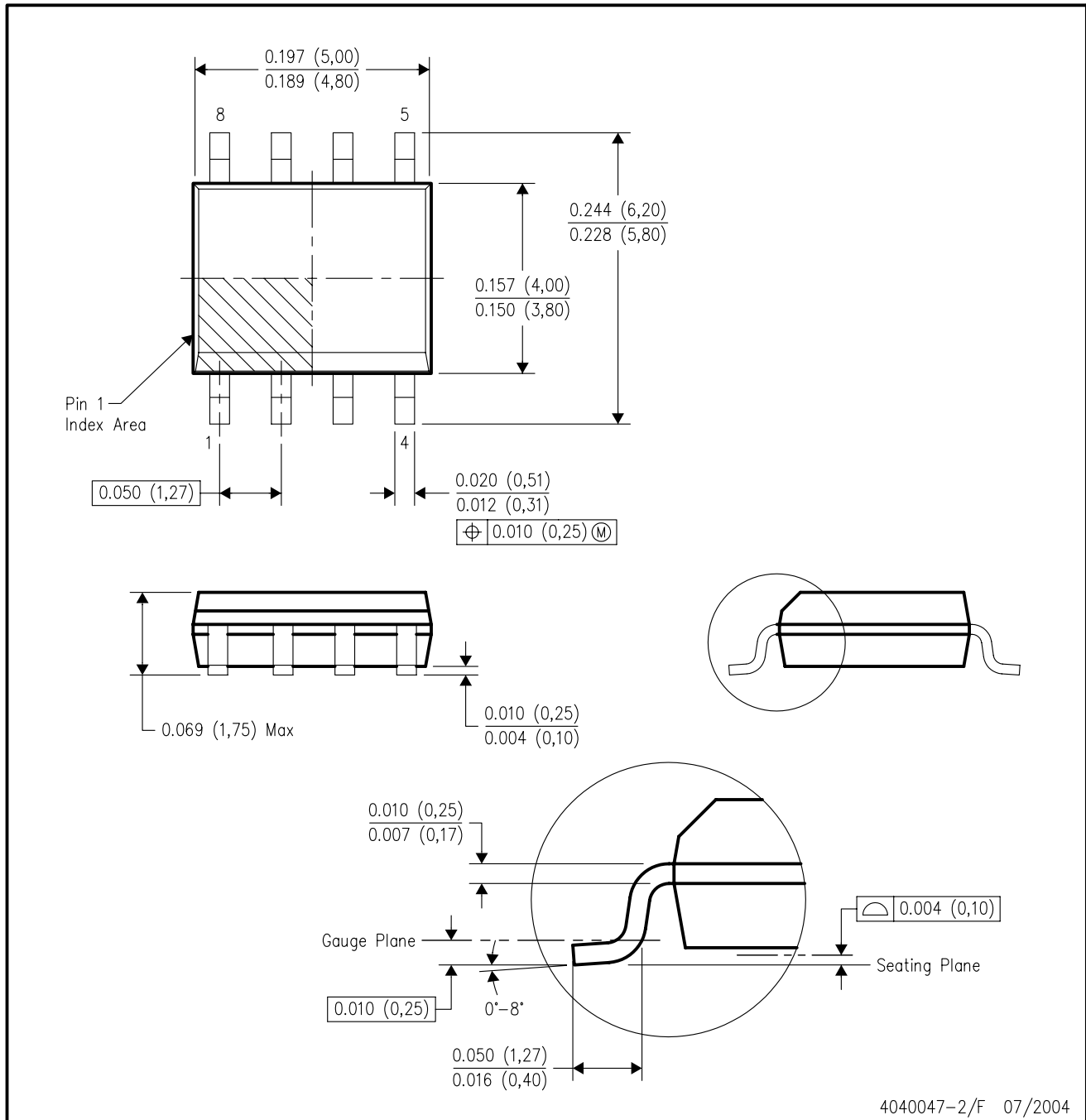

- NOTES:
- A. All linear dimensions are in inches (millimeters).
  - B. This drawing is subject to change without notice.
  - C. Body dimensions do not include mold flash or protrusion not to exceed 0.006 (0,15).
  - D. Falls within JEDEC MS-012 variation AA.

PW (R-PDSO-G\*\*)

PLASTIC SMALL-OUTLINE PACKAGE

14 PINS SHOWN

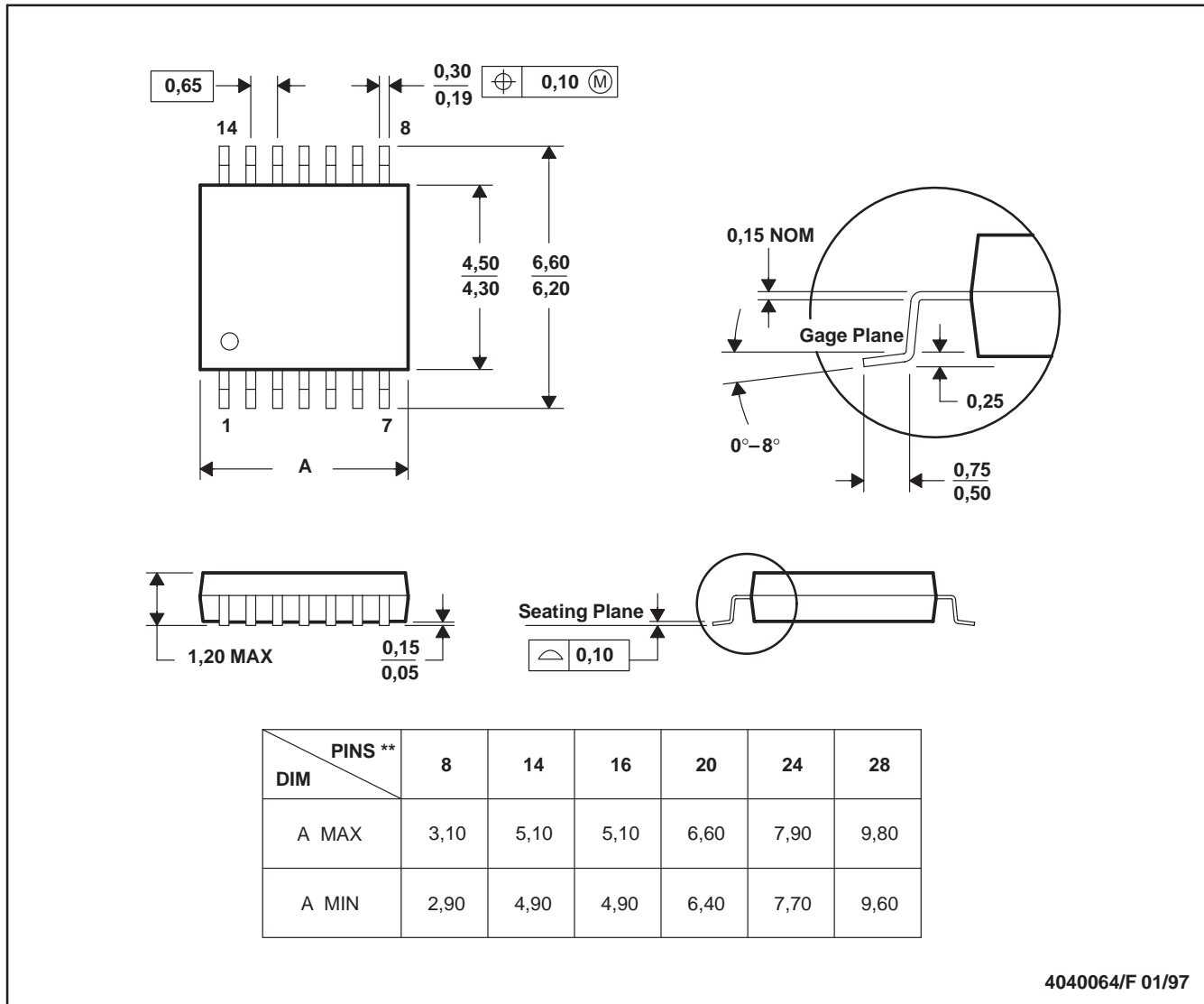

4040064/F 01/97

- NOTES: A. All linear dimensions are in millimeters.  
 B. This drawing is subject to change without notice.  
 C. Body dimensions do not include mold flash or protrusion not to exceed 0,15.  
 D. Falls within JEDEC MO-153

## IMPORTANT NOTICE

Texas Instruments Incorporated and its subsidiaries (TI) reserve the right to make corrections, modifications, enhancements, improvements, and other changes to its products and services at any time and to discontinue any product or service without notice. Customers should obtain the latest relevant information before placing orders and should verify that such information is current and complete. All products are sold subject to TI's terms and conditions of sale supplied at the time of order acknowledgment.

TI warrants performance of its hardware products to the specifications applicable at the time of sale in accordance with TI's standard warranty. Testing and other quality control techniques are used to the extent TI deems necessary to support this warranty. Except where mandated by government requirements, testing of all parameters of each product is not necessarily performed.

TI assumes no liability for applications assistance or customer product design. Customers are responsible for their products and applications using TI components. To minimize the risks associated with customer products and applications, customers should provide adequate design and operating safeguards.

TI does not warrant or represent that any license, either express or implied, is granted under any TI patent right, copyright, mask work right, or other TI intellectual property right relating to any combination, machine, or process in which TI products or services are used. Information published by TI regarding third-party products or services does not constitute a license from TI to use such products or services or a warranty or endorsement thereof. Use of such information may require a license from a third party under the patents or other intellectual property of the third party, or a license from TI under the patents or other intellectual property of TI.

Reproduction of information in TI data books or data sheets is permissible only if reproduction is without alteration and is accompanied by all associated warranties, conditions, limitations, and notices. Reproduction of this information with alteration is an unfair and deceptive business practice. TI is not responsible or liable for such altered documentation.

Resale of TI products or services with statements different from or beyond the parameters stated by TI for that product or service voids all express and any implied warranties for the associated TI product or service and is an unfair and deceptive business practice. TI is not responsible or liable for any such statements.

Following are URLs where you can obtain information on other Texas Instruments products and application solutions:

<b>Products</b>		<b>Applications</b>	
Amplifiers	<a href="http://amplifier.ti.com">amplifier.ti.com</a>	Audio	<a href="http://www.ti.com/audio">www.ti.com/audio</a>
Data Converters	<a href="http://dataconverter.ti.com">dataconverter.ti.com</a>	Automotive	<a href="http://www.ti.com/automotive">www.ti.com/automotive</a>
DSP	<a href="http://dsp.ti.com">dsp.ti.com</a>	Broadband	<a href="http://www.ti.com/broadband">www.ti.com/broadband</a>
Interface	<a href="http://interface.ti.com">interface.ti.com</a>	Digital Control	<a href="http://www.ti.com/digitalcontrol">www.ti.com/digitalcontrol</a>
Logic	<a href="http://logic.ti.com">logic.ti.com</a>	Military	<a href="http://www.ti.com/military">www.ti.com/military</a>
Power Mgmt	<a href="http://power.ti.com">power.ti.com</a>	Optical Networking	<a href="http://www.ti.com/opticalnetwork">www.ti.com/opticalnetwork</a>
Microcontrollers	<a href="http://microcontroller.ti.com">microcontroller.ti.com</a>	Security	<a href="http://www.ti.com/security">www.ti.com/security</a>
		Telephony	<a href="http://www.ti.com/telephony">www.ti.com/telephony</a>
		Video & Imaging	<a href="http://www.ti.com/video">www.ti.com/video</a>
		Wireless	<a href="http://www.ti.com/wireless">www.ti.com/wireless</a>

Mailing Address: Texas Instruments  
Post Office Box 655303 Dallas, Texas 75265