

TPS76901-Q1, TPS76912-Q1, TPS76915-Q1, TPS76918-Q1, TPS76925-Q1
 TPS76927-Q1, TPS76928-Q1, TPS76930-Q1, TPS76933-Q1, TPS76950-Q1
ULTRALOW-POWER 100-mA LOW-DROPOUT LINEAR REGULATORS

SGLS118A – DECEMBER 2001 – REVISED JANUARY 2002

- Qualification in Accordance With AEC-Q100†
- Qualified for Automotive Applications
- 100-mA Low-Dropout Regulator
- Available in 1.2-V, 1.5-V, 1.8-V, 2.5-V, 2.7-V, 2.8-V, 3.0-V, 3.3-V, and 5-V Fixed-Output and Adjustable Versions
- Only 17 μ A Quiescent Current at 100 mA
- 1 μ A Quiescent Current in Standby Mode
- Dropout Voltage Typically 71 mV at 100 mA
- Over Current Limitation
- -40°C to 125°C Operating Junction Temperature Range
- 5-Pin SOT-23 (DBV) Package

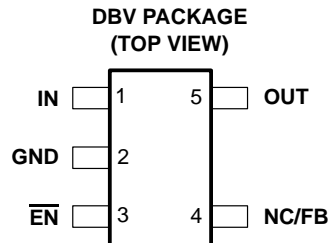

description

The TPS769xx-Q1 family of low-dropout (LDO) voltage regulators offers the benefits of low dropout voltage, ultralow-power operation, and miniaturized packaging. These regulators feature low dropout voltages and ultralow quiescent current compared to conventional LDO regulators. Offered in a 5-terminal small outline integrated-circuit SOT-23 package, the TPS769xx-Q1 series devices are ideal for micropower operations and where board space is at a premium.

A combination of new circuit design and process innovation has enabled the usual PNP pass transistor to be replaced by a PMOS pass element. Because the PMOS pass element behaves as a low-value resistor, the dropout

voltage is very low, typically 71 mV at 100 mA of load current (TPS76950-Q1), and is directly proportional to the load current. Since the PMOS pass element is a voltage-driven device, the quiescent current is ultralow (28 μ A maximum) and is stable over the entire range of output load current (0 mA to 100 mA). The ultralow-dropout voltage feature and ultralow-power operation result in a significant increase in system battery operating life, making this device suitable for use in automotive applications.

The TPS769xx-Q1 also features a logic-enabled sleep mode to shut down the regulator, reducing quiescent current to 1 μ A typical at $T_J = 25^{\circ}\text{C}$. The TPS769xx-Q1 is offered in 1.2-V, 1.5-V, 1.8-V, 2.5-V, 2.7-V, 2.8-V, 3.0-V, 3.3-V, and 5-V fixed-voltage versions and in a variable version (programmable over the range of 1.2 V to 5.5 V).

TPS76933
 GROUND CURRENT
 vs
 FREE-AIR TEMPERATURE

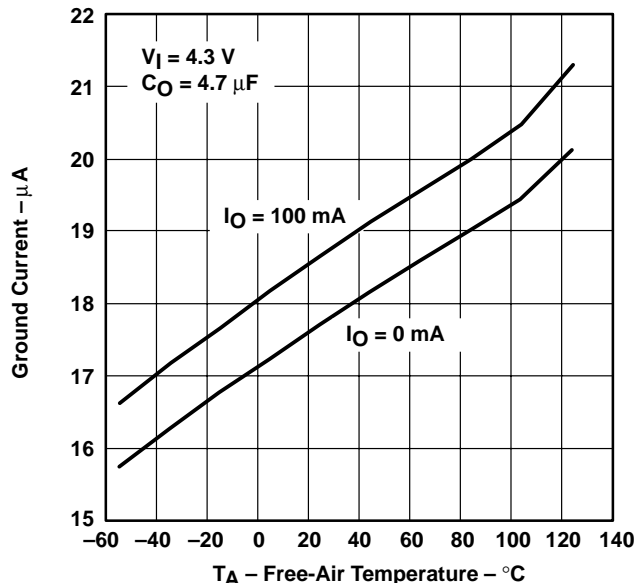

† Contact factory for details. Q100 qualification data available on request.



Please be aware that an important notice concerning availability, standard warranty, and use in critical applications of Texas Instruments semiconductor products and disclaimers thereto appears at the end of this data sheet.

PRODUCTION DATA information is current as of publication date. Products conform to specifications per the terms of Texas Instruments standard warranty. Production processing does not necessarily include testing of all parameters.



POST OFFICE BOX 655303 • DALLAS, TEXAS 75265

Copyright © 2002, Texas Instruments Incorporated

**TPS76901-Q1, TPS76912-Q1, TPS76915-Q1, TPS76918-Q1, TPS76925-Q1
 TPS76927-Q1, TPS76928-Q1, TPS76930-Q1, TPS76933-Q1, TPS76950-Q1
 ULTRALOW-POWER 100-mA LOW-DROPOUT LINEAR REGULATORS**

SGLS118A – DECEMBER 2001 – REVISED JANUARY 2002

AVAILABLE OPTIONS

T _J	VOLTAGE	PACKAGE	PART NUMBER		SYMBOL
-40°C to 125°C	Variable 1.2V to 5.5V	SOT-23 (DBV)	TPS76901QDBVTQ1†	TPS76901QDBVRQ1‡	PCFQ
	1.2 V		TPS76912QDBVTQ1†	TPS76912QDBVRQ1‡	PCGQ
	1.5 V		TPS76915QDBVTQ1†	TPS76915QDBVRQ1‡	PCHQ
	1.8 V		TPS76918QDBVTQ1†	TPS76918QDBVRQ1‡	PCIQ
	2.5 V		TPS76925QDBVTQ1†	TPS76925QDBVRQ1‡	PCJQ
	2.7 V		TPS76927QDBVTQ1†	TPS76927QDBVRQ1‡	PCKQ
	2.8 V		TPS76928QDBVTQ1†	TPS76928QDBVRQ1‡	PCLQ
	3.0 V		TPS76930QDBVTQ1†	TPS76930QDBVRQ1‡	PCMQ
	3.3 V		TPS76933QDBVTQ1†	TPS76933QDBVRQ1‡	PCNQ
	5.0 V		TPS76950QDBVTQ1†	TPS76950QDBVRQ1‡	PCOQ

† The DBVT indicates tape and reel of 250 parts.

‡ The DBVR indicates tape and reel of 3000 parts.

functional block diagram

TPS76901-Q1

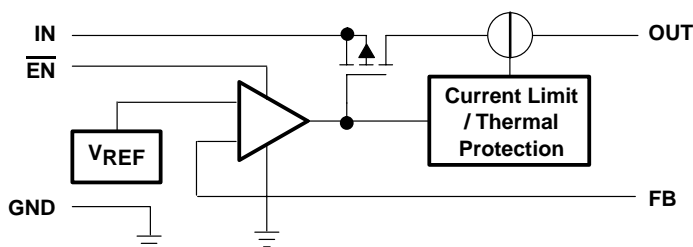

TPS76912/15/18/25/27/28/30/33/50-Q1

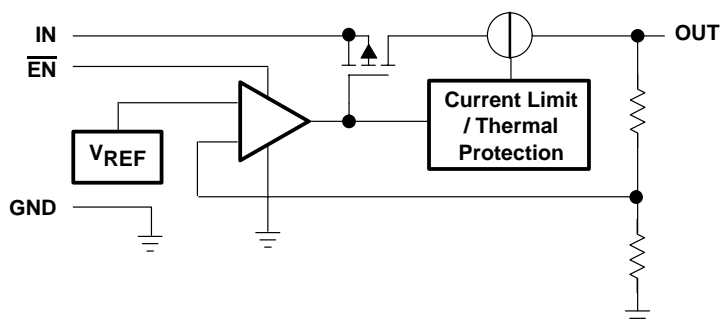

**TPS76901-Q1, TPS76912-Q1, TPS76915-Q1, TPS76918-Q1, TPS76925-Q1
TPS76927-Q1, TPS76928-Q1, TPS76930-Q1, TPS76933-Q1, TPS76950-Q1
ULTRALOW-POWER 100-mA LOW-DROPOUT LINEAR REGULATORS**

SGLS118A – DECEMBER 2001 – REVISED JANUARY 2002

Terminal Functions

TERMINAL NAME	NO.	I/O	DESCRIPTION
GND	2		Ground
$\overline{\text{EN}}$	3	I	Enable input
FB	4	I	Feedback voltage (TPS76901-Q1 only)
IN	1	I	Input supply voltage
NC	4		No connection (Fixed options only)
OUT	5	O	Regulated output voltage

absolute maximum ratings over operating free-air temperature range (unless otherwise noted)[†]

Input voltage range (see Note 1)	–0.3 V to 13.5 V
Voltage range at $\overline{\text{EN}}$	–0.3 V to $V_I + 0.3$ V
Voltage on OUT, FB	7 V
Peak output current	Internally limited
ESD rating, HBM	2 kV
Continuous total power dissipation	See Dissipation Rating Table
Operating virtual junction temperature range, T_J	–40°C to 150°C
Storage temperature range, T_{stg}	–65°C to 150°C

[†] Stresses beyond those listed under “absolute maximum ratings” may cause permanent damage to the device. These are stress ratings only, and functional operation of the device at these or any other conditions beyond those indicated under “recommended operating conditions” is not implied. Exposure to absolute-maximum-rated conditions for extended periods may affect device reliability.

NOTE 1: All voltage values are with respect to network ground terminal.

DISSIPATION RATING TABLE

BOARD	PACKAGE	$R_{\theta JC}$	$R_{\theta JA}$	DERATING FACTOR ABOVE $T_A = 25^\circ\text{C}$	$T_A \leq 25^\circ\text{C}$ POWER RATING	$T_A = 70^\circ\text{C}$ POWER RATING	$T_A = 85^\circ\text{C}$ POWER RATING
Low K [‡]	DBV	65.8 °C/W	259 °C/W	3.9 mW/°C	386 mW	212 mW	154 mW
High K [§]	DBV	65.8 °C/W	180 °C/W	5.6 mW/°C	555 mW	305 mW	222 mW

[‡] The JEDEC Low K (1s) board design used to derive this data was a 3 inch x 3 inch, two layer board with 2 ounce copper traces on top of the board.

[§] The JEDEC High K (2s2p) board design used to derive this data was a 3 inch x 3 inch, multilayer board with 1 ounce internal power and ground planes and 2 ounce copper traces on top and bottom of the board.

recommended operating conditions

	MIN	NOM	MAX	UNIT
Input voltage, V_I (see Note 2)	2.7		10	V
Output voltage range, V_O	1.2		5.5	V
Continuous output current, I_O (see Note 3)	0		100	mA
Operating junction temperature, T_J	–40		125	°C

NOTES: 2. To calculate the minimum input voltage for your maximum output current, use the following formula:

$$V_I(\text{min}) = V_O(\text{max}) + V_{\text{DO}}(\text{max load})$$

3. Continuous output current and operating junction temperature are limited by internal protection circuitry, but it is not recommended that the device operate under conditions beyond those specified in this table for extended periods of time.



**TPS76901-Q1, TPS76912-Q1, TPS76915-Q1, TPS76918-Q1, TPS76925-Q1
 TPS76927-Q1, TPS76928-Q1, TPS76930-Q1, TPS76933-Q1, TPS76950-Q1
 ULTRALOW-POWER 100-mA LOW-DROPOUT LINEAR REGULATORS**

SGLS118A – DECEMBER 2001 – REVISED JANUARY 2002

**electrical characteristics over recommended operating free-air temperature range,
 $V_I = V_{O(typ)} + 1\text{ V}$, $I_O = 100\text{ mA}$, $\overline{EN} = 0\text{ V}$, $C_O = 4.7\text{ }\mu\text{F}$ (unless otherwise noted)**

PARAMETER		TEST CONDITIONS	MIN	TYP	MAX	UNIT
Output voltage (10 μA to 100 mA load) (see Note 4)	TPS76901-Q1	$1.2\text{ V} \leq V_O \leq 5.5\text{ V}$, $T_J = 25^\circ\text{C}$	V_O			V
		$1.2\text{ V} \leq V_O \leq 5.5\text{ V}$, $T_J = -40^\circ\text{C}$ to 125°C	$0.97V_O$		$1.03V_O$	
	TPS76912-Q1	$T_J = 25^\circ\text{C}$, $2.7\text{ V} < V_{IN} < 10\text{ V}$	1.224			
		$T_J = -40^\circ\text{C}$ to 125°C , $2.7\text{ V} < V_{IN} < 10\text{ V}$	1.187		1.261	
	TPS76915-Q1	$T_J = 25^\circ\text{C}$, $2.7\text{ V} < V_{IN} < 10\text{ V}$	1.5			
		$T_J = -40^\circ\text{C}$ to 125°C , $2.7\text{ V} < V_{IN} < 10\text{ V}$	1.455		1.545	
	TPS76918-Q1	$T_J = 25^\circ\text{C}$, $2.8\text{ V} < V_{IN} < 10\text{ V}$	1.8			
		$T_J = -40^\circ\text{C}$ to 125°C , $2.8\text{ V} < V_{IN} < 10\text{ V}$	1.746		1.854	
	TPS76925-Q1	$T_J = 25^\circ\text{C}$, $3.5\text{ V} < V_{IN} < 10\text{ V}$	2.5			
		$T_J = -40^\circ\text{C}$ to 125°C , $3.5\text{ V} < V_{IN} < 10\text{ V}$	2.425		2.575	
	TPS76927-Q1	$T_J = 25^\circ\text{C}$, $3.7\text{ V} < V_{IN} < 10\text{ V}$	2.7			
		$T_J = -40^\circ\text{C}$ to 125°C , $3.7\text{ V} < V_{IN} < 10\text{ V}$	2.619		2.781	
	TPS76928-Q1	$T_J = 25^\circ\text{C}$, $3.8\text{ V} < V_{IN} < 10\text{ V}$	2.8			
		$T_J = -40^\circ\text{C}$ to 125°C , $3.8\text{ V} < V_{IN} < 10\text{ V}$	2.716		2.884	
	TPS76930-Q1	$T_J = 25^\circ\text{C}$, $4.0\text{ V} < V_{IN} < 10\text{ V}$	3.0			
		$T_J = -40^\circ\text{C}$ to 125°C , $4.0\text{ V} < V_{IN} < 10\text{ V}$	2.910		3.090	
	TPS76933-Q1	$T_J = 25^\circ\text{C}$, $4.3\text{ V} < V_{IN} < 10\text{ V}$	3.3			
		$T_J = -40^\circ\text{C}$ to 125°C , $4.3\text{ V} < V_{IN} < 10\text{ V}$	3.201		3.399	
TPS76950-Q1	$T_J = 25^\circ\text{C}$, $6.0\text{ V} < V_{IN} < 10\text{ V}$	5.0				
	$T_J = -40^\circ\text{C}$ to 125°C , $6.0\text{ V} < V_{IN} < 10\text{ V}$	4.850		5.150		
Quiescent current (GND current) (see Notes 4 and 5)	$\overline{EN} = 0\text{ V}$, $T_J = 25^\circ\text{C}$ $0\text{ mA} < I_O < 100\text{ mA}$,		17		μA	
		$\overline{EN} = 0\text{ V}$, $T_J = -40^\circ\text{C}$ to 125°C $I_O = 100\text{ mA}$,		28		
Load regulation	$\overline{EN} = 0\text{ V}$, $T_J = 25^\circ\text{C}$ $I_O = 0$ to 100 mA ,		12		mV	
Output voltage line regulation ($\Delta V_O/V_O$) (see Note 5)	$V_O + 1\text{ V} < V_I \leq 10\text{ V}$, $T_J = 25^\circ\text{C}$, See Note 4		0.04		%V	
		$V_O + 1\text{ V} < V_I \leq 10\text{ V}$, $T_J = -40^\circ\text{C}$ to 125°C , See Note 4		0.1		
Output noise voltage	BW = 300 Hz to 50 kHz, $C_O = 10\text{ }\mu\text{F}$, $T_J = 25^\circ\text{C}$		190		μVrms	
Output current limit	$V_O = 0\text{ V}$, See Note 4		350	750	mA	
Standby current	$\overline{EN} = V_I$, $2.7 < V_I < 10\text{ V}$ $T_J = -40^\circ\text{C}$ to 125°C		1		μA	
				2		μA

NOTES: 4. Minimum IN operating voltage is 2.7 V or $V_{O(typ)} + 1\text{ V}$, whichever is greater. Maximum IN voltage 10 V, minimum output current 10 μA , maximum output current 100 mA.

5. If $V_O \leq 1.8\text{ V}$ then $V_{Imin} = 2.7\text{ V}$, $V_{Imax} = 10\text{ V}$:

$$\text{Line Reg. (mV)} = (\%/V) \times \frac{V_O(V_{Imax} - 2.7\text{ V})}{100} \times 1000$$

If $V_O \geq 2.5\text{ V}$ then $V_{Imin} = V_O + 1\text{ V}$, $V_{Imax} = 10\text{ V}$:

$$\text{Line Reg. (mV)} = (\%/V) \times \frac{V_O(V_{Imax} - (V_O + 1\text{ V}))}{100} \times 1000$$



**TPS76901-Q1, TPS76912-Q1, TPS76915-Q1, TPS76918-Q1, TPS76925-Q1
 TPS76927-Q1, TPS76928-Q1, TPS76930-Q1, TPS76933-Q1, TPS76950-Q1
 ULTRALOW-POWER 100-mA LOW-DROPOUT LINEAR REGULATORS**

SGLS118A – DECEMBER 2001 – REVISED JANUARY 2002

**electrical characteristics over recommended operating free-air temperature range,
 $V_I = V_{O(typ)} + 1\text{ V}$, $I_O = 100\text{ mA}$, $\overline{EN} = 0\text{ V}$, $C_O = 4.7\text{ }\mu\text{F}$ (unless otherwise noted) (continued)**

PARAMETER		TEST CONDITIONS		MIN	TYP	MAX	UNIT
FB input current		FB = 1.224 V (TPS76901-Q1)		-1		1	μA
High level enable input voltage		$2.7\text{ V} < V_I < 10\text{ V}$		1.7			V
Low level enable input voltage		$2.7\text{ V} < V_I < 10\text{ V}$				0.9	V
Power supply ripple rejection		$f = 1\text{ kHz}$, $T_J = 25^\circ\text{C}$,	$C_O = 10\text{ }\mu\text{F}$, See Note 4		60		dB
Input current (EN)		$\overline{EN} = 0\text{ V}$		-1	0	1	μA
		$\overline{EN} = V_I$		-1		1	μA
Dropout voltage (see Note 6)	TPS76928-Q1	$I_O = 50\text{ mA}$,	$T_J = 25^\circ\text{C}$		60		mV
		$I_O = 50\text{ mA}$,	$T_J = -40^\circ\text{C to } 125^\circ\text{C}$			125	
		$I_O = 100\text{ mA}$,	$T_J = 25^\circ\text{C}$		122		
		$I_O = 100\text{ mA}$,	$T_J = -40^\circ\text{C to } 125^\circ\text{C}$			245	
	TPS76930-Q1	$I_O = 50\text{ mA}$,	$T_J = 25^\circ\text{C}$		57		
		$I_O = 50\text{ mA}$,	$T_J = -40^\circ\text{C to } 125^\circ\text{C}$			115	
		$I_O = 100\text{ mA}$,	$T_J = 25^\circ\text{C}$		115		
		$I_O = 100\text{ mA}$,	$T_J = -40^\circ\text{C to } 125^\circ\text{C}$			230	
	TPS76933-Q1	$I_O = 50\text{ mA}$,	$T_J = 25^\circ\text{C}$		48		
		$I_O = 50\text{ mA}$,	$T_J = -40^\circ\text{C to } 125^\circ\text{C}$			100	
		$I_O = 100\text{ mA}$,	$T_J = 25^\circ\text{C}$		98		
		$I_O = 100\text{ mA}$,	$T_J = -40^\circ\text{C to } 125^\circ\text{C}$			200	
	TPS76950-Q1	$I_O = 50\text{ mA}$,	$T_J = 25^\circ\text{C}$		35		
		$I_O = 50\text{ mA}$,	$T_J = -40^\circ\text{C to } 125^\circ\text{C}$			85	
		$I_O = 100\text{ mA}$,	$T_J = 25^\circ\text{C}$		71		
		$I_O = 100\text{ mA}$,	$T_J = -40^\circ\text{C to } 125^\circ\text{C}$			170	

NOTES: 4. Minimum IN operating voltage is 2.7 V or $V_{O(typ)} + 1\text{ V}$, whichever is greater. Maximum IN voltage 10 V, minimum output current 10 μA , maximum output current 100 mA.

6. IN voltage equals $V_{O(Typ)} - 100\text{mV}$; TPS76901-Q1 output voltage set to 3.3V nominal with external resistor divider. TPS76912-Q1, TPS76915-Q1, TPS76918-Q1, TPS76925-Q1, and TPS76927-Q1 dropout voltage limited by input voltage range limitations.

PICAL CHARACTERISTICS

Table of Graphs

			FIGURE
V_O	Output voltage	vs Output current	1, 2, 3
		vs Free-air temperature	4, 5, 6
	Ground current	vs Free-air temperature	7
	Output spectral noise density	vs Frequency	8
Z_O	Output impedance	vs Frequency	9
V_{DO}	Dropout voltage	vs Free-air temperature	10
	Ripple rejection	vs Frequency	11
	LDO startup time		12
	Line transient response		13, 15
	Load transient response		14, 16
	Equivalent series resistance (ESR)	vs Output current	17, 19
		vs Added ceramic capacitance	18, 20



TPS76901-Q1, TPS76912-Q1, TPS76915-Q1, TPS76918-Q1, TPS76925-Q1
 TPS76927-Q1, TPS76928-Q1, TPS76930-Q1, TPS76933-Q1, TPS76950-Q1
 ULTRALOW-POWER 100-mA LOW-DROPOUT LINEAR REGULATORS

SGLS118A – DECEMBER 2001 – REVISED JANUARY 2002

TYPICAL CHARACTERISTICS

TPS76925
 OUTPUT VOLTAGE
 vs
 OUTPUT CURRENT

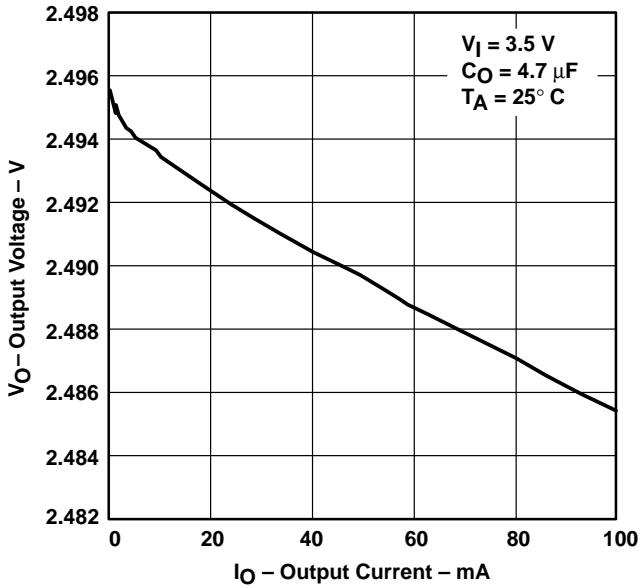

Figure 1

TPS76915
 OUTPUT VOLTAGE
 vs
 OUTPUT CURRENT

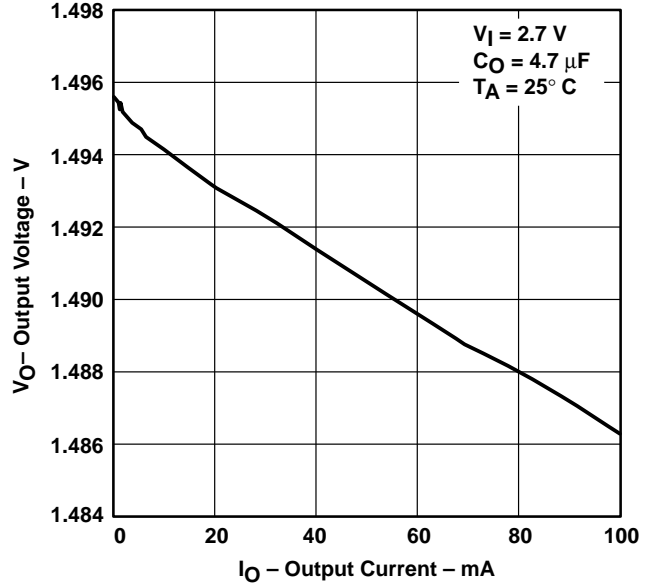

Figure 2

TPS76933
 OUTPUT VOLTAGE
 vs
 OUTPUT CURRENT

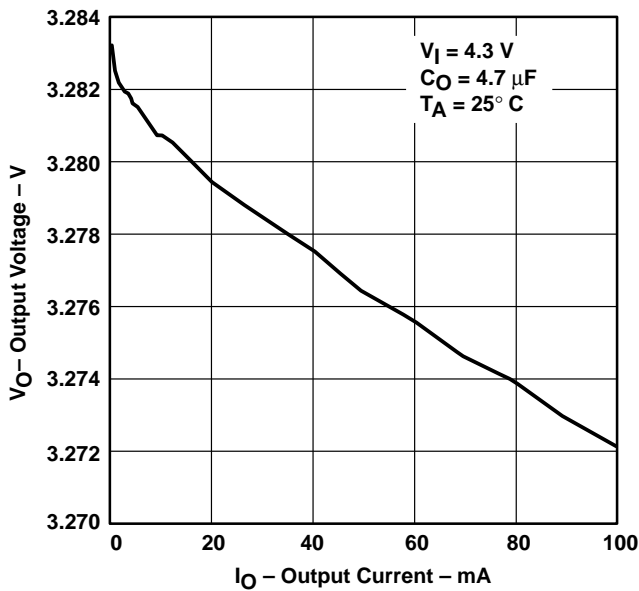

Figure 3

TPS76915
 OUTPUT VOLTAGE
 vs
 FREE-AIR TEMPERATURE

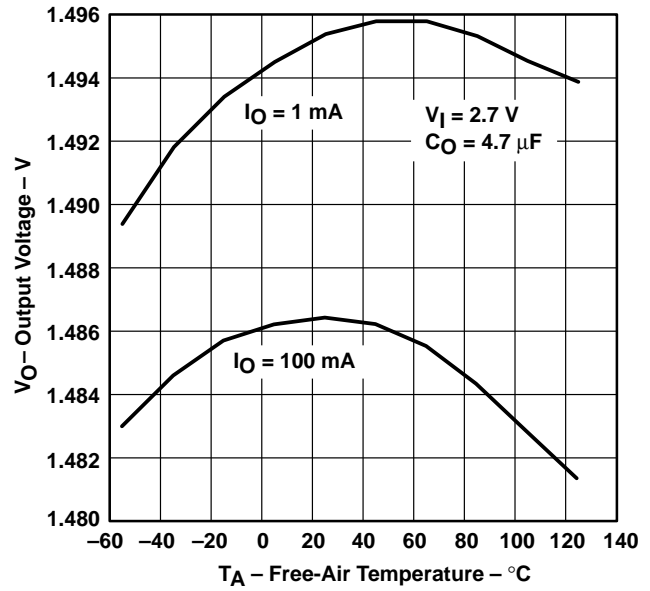

Figure 4



TPS76901-Q1, TPS76912-Q1, TPS76915-Q1, TPS76918-Q1, TPS76925-Q1
 TPS76927-Q1, TPS76928-Q1, TPS76930-Q1, TPS76933-Q1, TPS76950-Q1
ULTRALOW-POWER 100-mA LOW-DROPOUT LINEAR REGULATORS

SGLS118A – DECEMBER 2001 – REVISED JANUARY 2002

TYPICAL CHARACTERISTICS

TPS76925
 OUTPUT VOLTAGE
 VS
 FREE-AIR TEMPERATURE

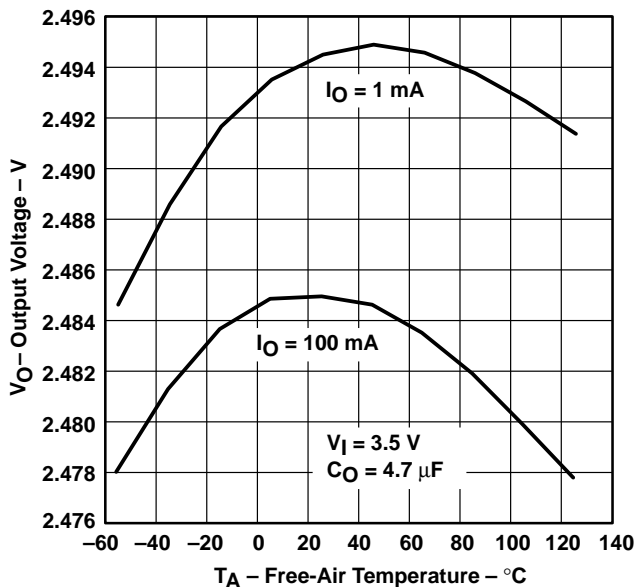

Figure 5

TPS76933
 OUTPUT VOLTAGE
 VS
 FREE-AIR TEMPERATURE

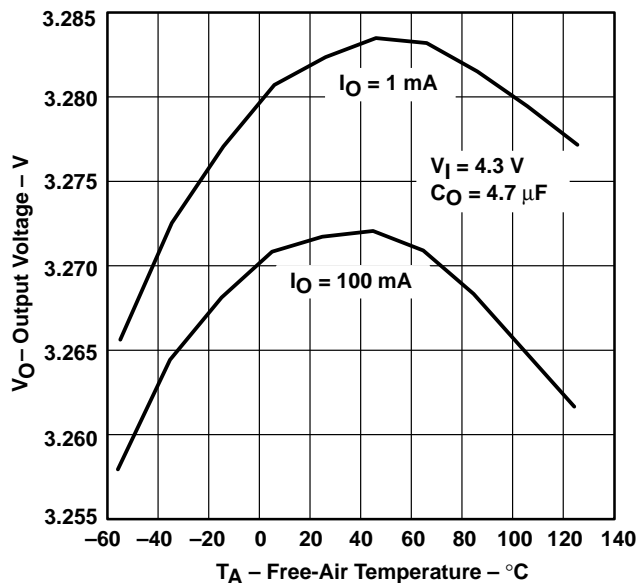

Figure 6

TPS76933
 GROUND CURRENT
 VS
 FREE-AIR TEMPERATURE

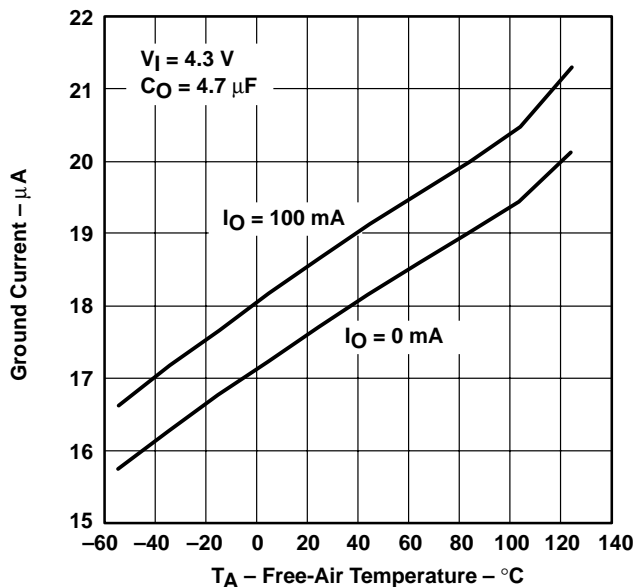

Figure 7

TPS76933
 OUTPUT SPECTRAL NOISE DENSITY
 VS
 FREQUENCY

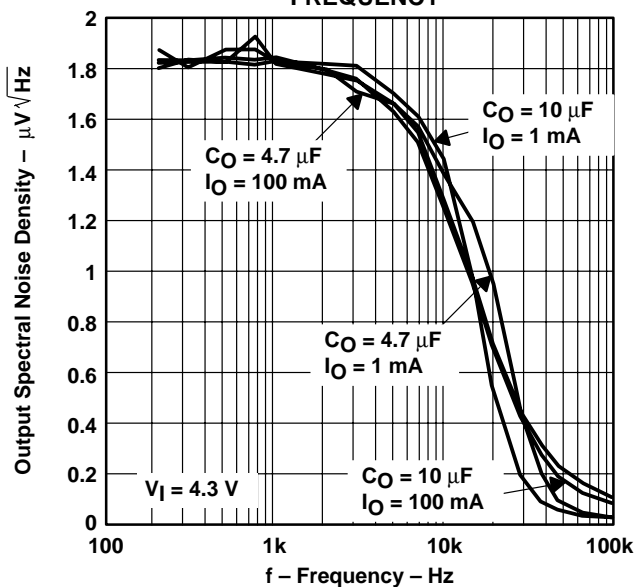

Figure 8

TYPICAL CHARACTERISTICS

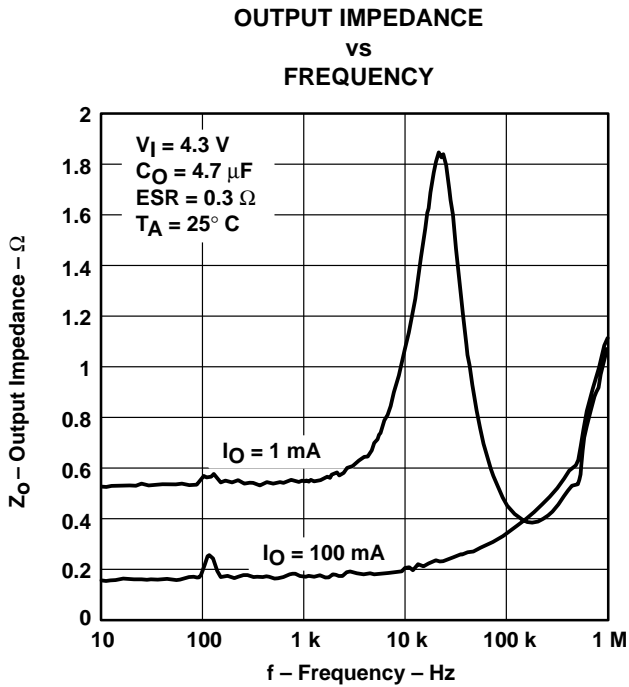

Figure 9

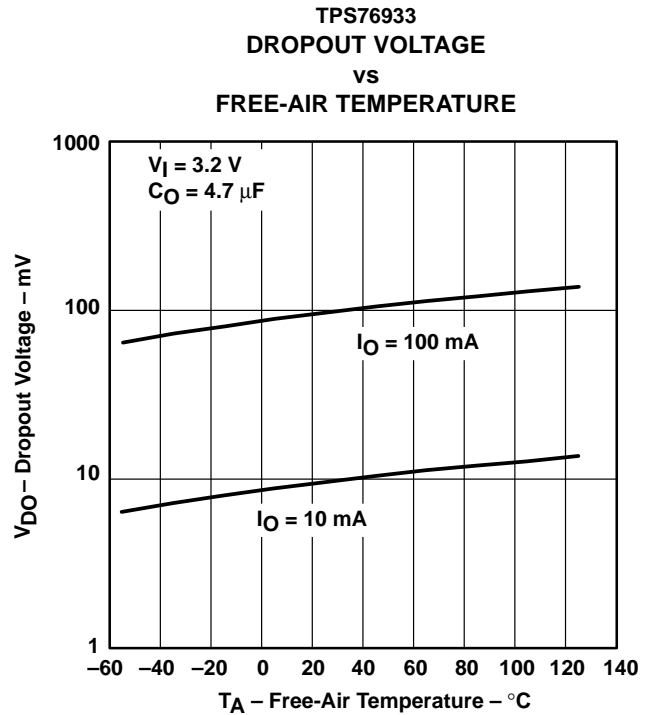

Figure 10

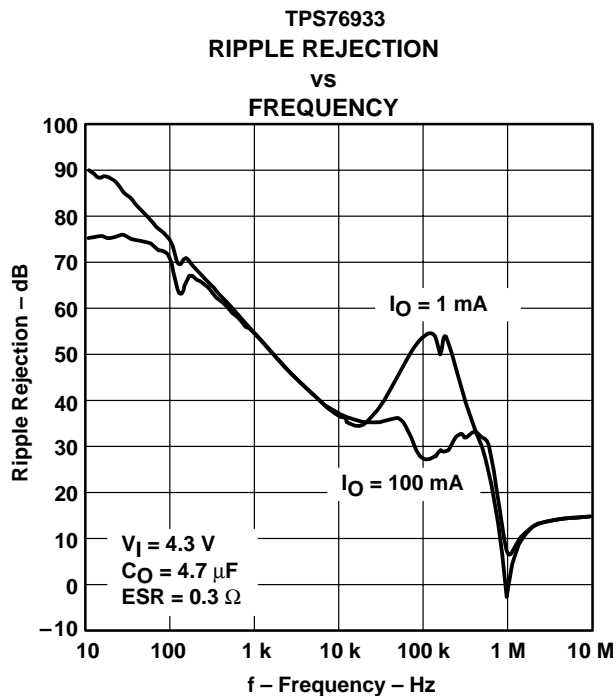

Figure 11

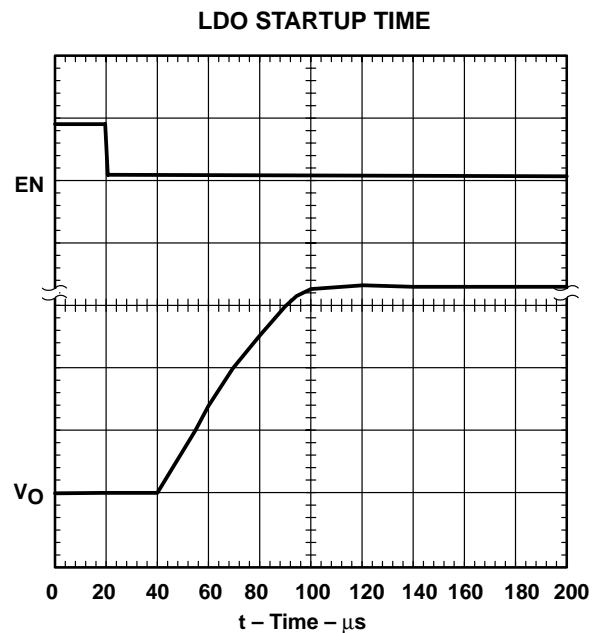

Figure 12

TPS76901-Q1, TPS76912-Q1, TPS76915-Q1, TPS76918-Q1, TPS76925-Q1
 TPS76927-Q1, TPS76928-Q1, TPS76930-Q1, TPS76933-Q1, TPS76950-Q1
 ULTRALOW-POWER 100-mA LOW-DROPOUT LINEAR REGULATORS

SGLS118A – DECEMBER 2001 – REVISED JANUARY 2002

TYPICAL CHARACTERISTICS

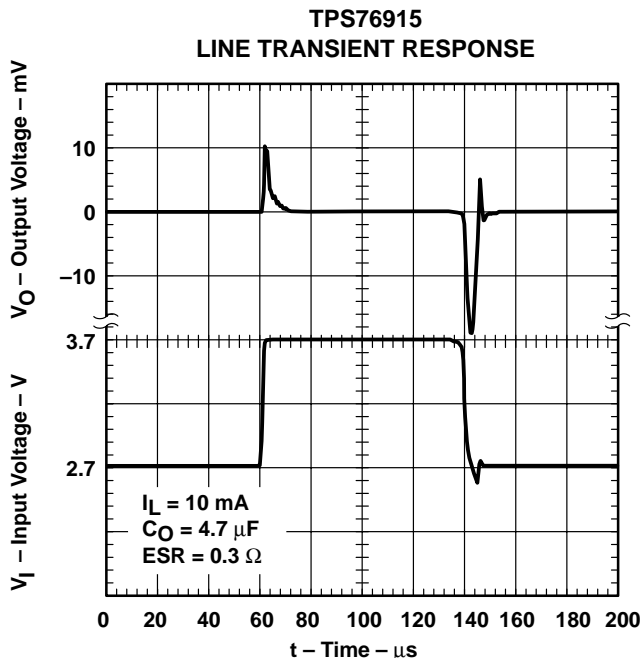

Figure 13

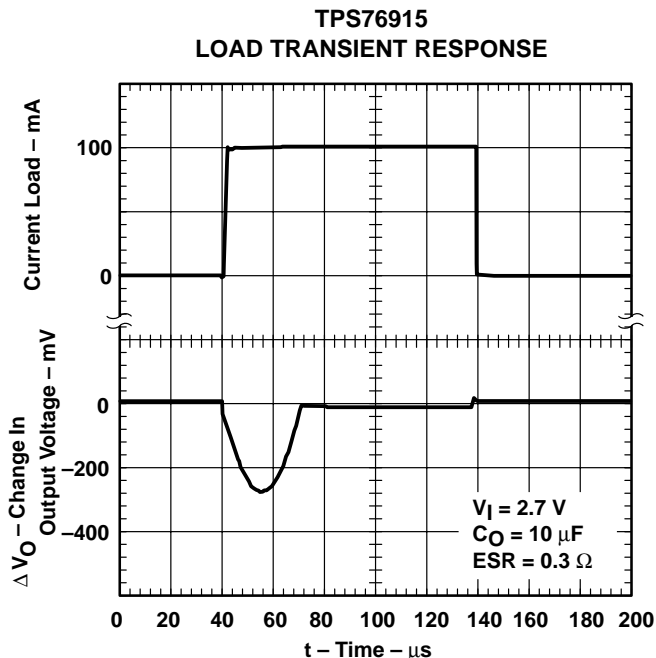

Figure 14

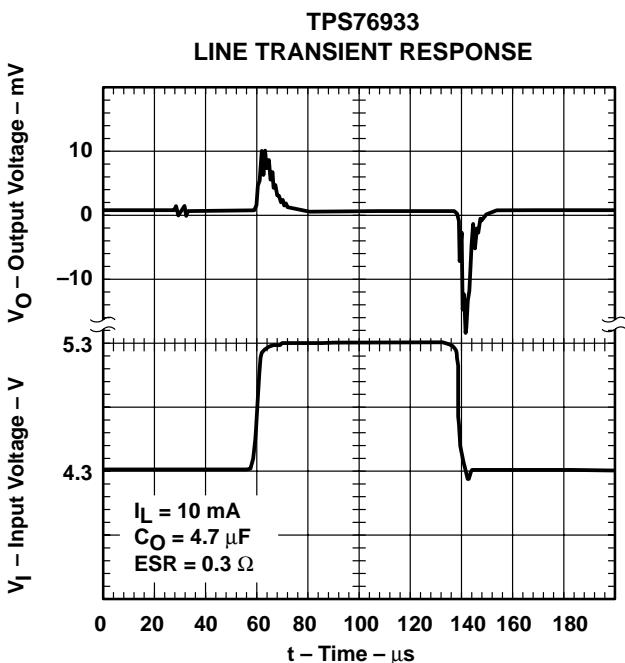

Figure 15

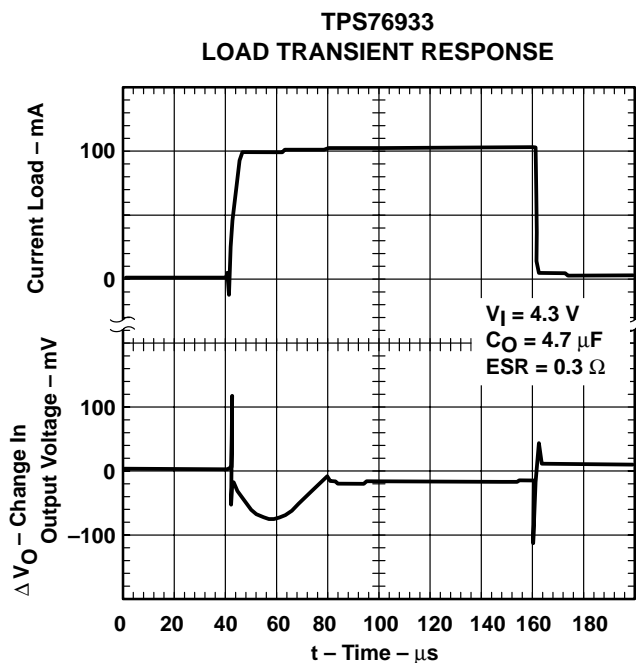

Figure 16

TYPICAL CHARACTERISTICS

TPS76933
 TYPICAL REGIONS OF STABILITY
 EQUIVALENT SERIES RESISTANCE (ESR)[†]
 VS
 OUTPUT CURRENT

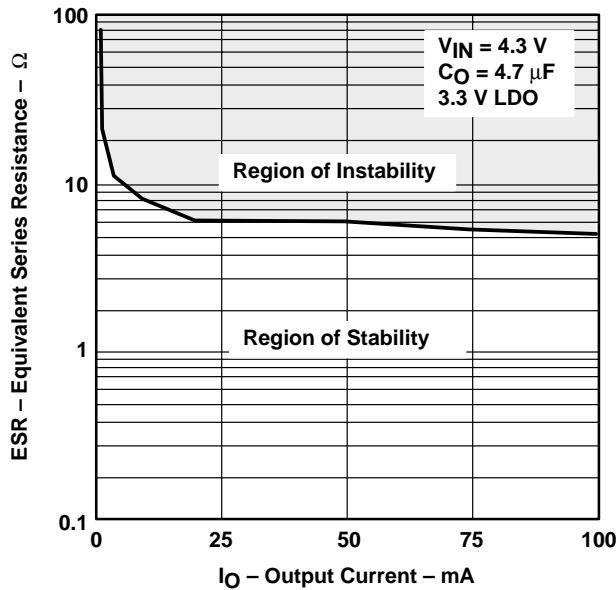

Figure 17

TPS76933
 TYPICAL REGIONS OF STABILITY
 EQUIVALENT SERIES RESISTANCE (ESR)
 VS
 ADDED CERAMIC CAPACITANCE

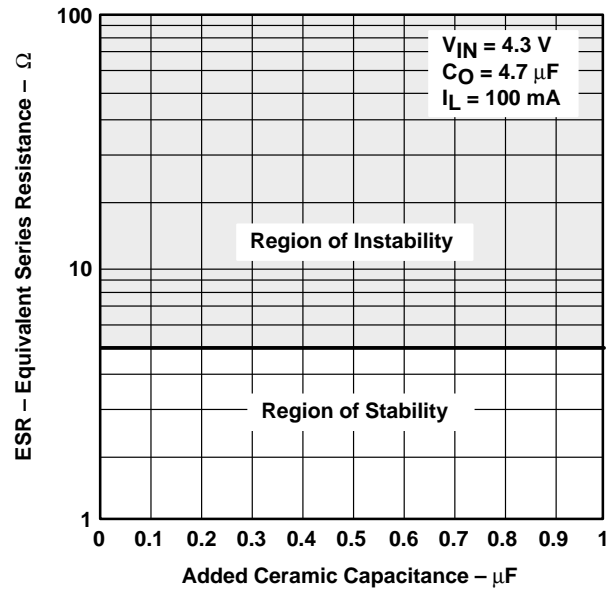

Figure 18

TPS76933
 TYPICAL REGIONS OF STABILITY
 EQUIVALENT SERIES RESISTANCE (ESR)[†]
 VS
 OUTPUT CURRENT

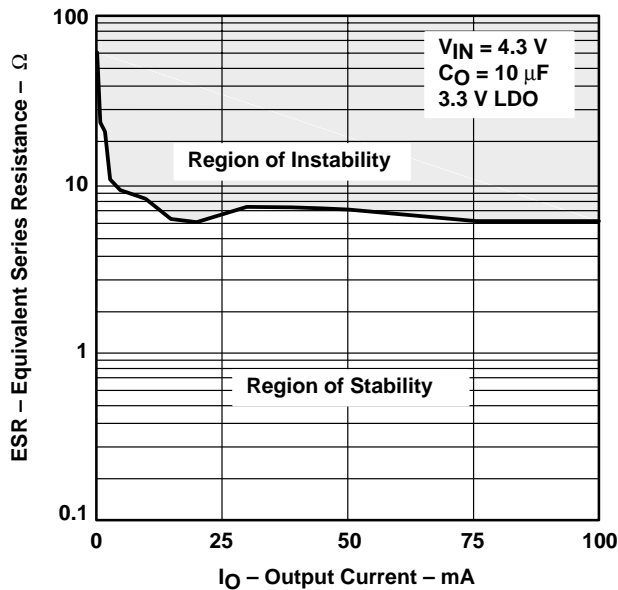

Figure 19

TPS76933
 TYPICAL REGIONS OF STABILITY
 EQUIVALENT SERIES RESISTANCE (ESR)
 VS
 ADDED CERAMIC CAPACITANCE

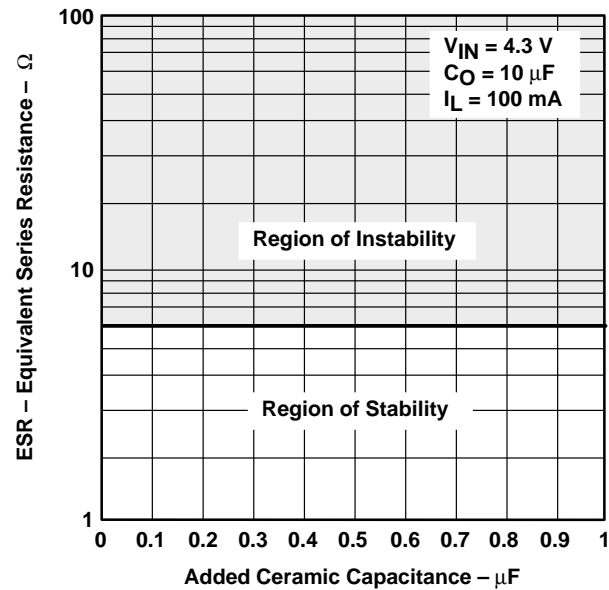

Figure 20

APPLICATION INFORMATION

The TPS769xx family of low-dropout (LDO) regulators have been optimized for use in battery-operated equipment and automotive applications. They feature extremely low dropout voltages, low quiescent current (17 μA nominally), and enable inputs to reduce supply currents to 1 μA when the regulators are turned off.

device operation

The TPS769xx uses a PMOS pass element to dramatically reduce both dropout voltage and supply current over more conventional PNP-pass-element LDO designs. The PMOS pass element is a voltage-controlled device and, unlike a PNP transistor, it does not require increased drive current as output current increases. Supply current in the TPS769xx is essentially constant from no load to maximum load.

Current limiting and thermal protection prevent damage by excessive output current and/or power dissipation. The device switches into a constant-current mode at approximately 350 mA; further load reduces the output voltage instead of increasing the output current. The thermal protection shuts the regulator off if the junction temperature rises above approximately 165°C. Recovery is automatic when the junction temperature drops approximately 25°C below the high temperature trip point. The PMOS pass element includes a back gate diode that conducts reverse current when the input voltage level drops below the output voltage level.

A voltage of 1.7 V or greater on the $\overline{\text{EN}}$ input will disable the TPS769xx internal circuitry, reducing the supply current to 1 μA . A voltage of less than 0.9 V on the $\overline{\text{EN}}$ input will enable the TPS769xx and will enable normal operation to resume. The $\overline{\text{EN}}$ input does not include any deliberate hysteresis, and it exhibits an actual switching threshold of approximately 1.5 V.

A typical application circuit is shown in Figure 21.

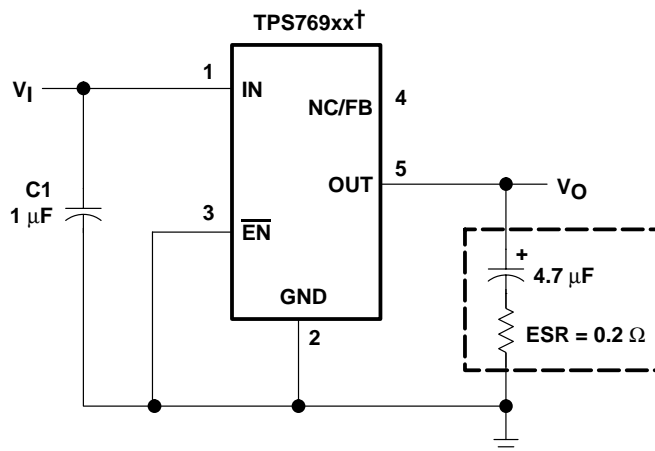

† TPS76912, TPS76915, TPS76918, TPS76925, TPS76927, TPS76928,
 TPS76930, TPS76933, TPS76950 (fixed-voltage options).

Figure 21. Typical Application Circuit

**TPS76901-Q1, TPS76912-Q1, TPS76915-Q1, TPS76918-Q1, TPS76925-Q1
TPS76927-Q1, TPS76928-Q1, TPS76930-Q1, TPS76933-Q1, TPS76950-Q1
ULTRALOW-POWER 100-mA LOW-DROPOUT LINEAR REGULATORS**

SGLS118A – DECEMBER 2001 – REVISED JANUARY 2002

APPLICATION INFORMATION

external capacitor requirements

Although not required, a 0.047- μ F or larger ceramic input bypass capacitor, connected between IN and GND and located close to the TPS769xx, is recommended to improve transient response and noise rejection. A higher-value electrolytic input capacitor may be necessary if large, fast-rise-time load transients are anticipated and the device is located several inches from the power source.

Like all low dropout regulators, the TPS769xx requires an output capacitor connected between OUT and GND to stabilize the internal control loop. The minimum recommended capacitance is 4.7 μ F. The ESR (equivalent series resistance) of the capacitor should be between 0.2 Ω and 10 Ω . to ensure stability. Capacitor values larger than 4.7 μ F are acceptable, and allow the use of smaller ESR values. Capacitances less than 4.7 μ F are not recommended because they require careful selection of ESR to ensure stability. Solid tantalum electrolytic, aluminum electrolytic, and multilayer ceramic capacitors are all suitable, provided they meet the requirements described above. Most of the commercially available 4.7 μ F surface-mount solid tantalum capacitors, including devices from Sprague, Kemet, and Nichico, meet the ESR requirements stated above. Multilayer ceramic capacitors may have very small equivalent series resistances and may thus require the addition of a low value series resistor to ensure stability.

CAPACITOR SELECTION

PART NO.	MFR.	VALUE	MAX ESR†	SIZE (H \times L \times W)†
T494B475K016AS	KEMET	4.7 μ F	1.5 Ω	1.9 \times 3.5 \times 2.8
195D106x0016x2T	SPRAGUE	10 μ F	1.5 Ω	1.3 \times 7.0 \times 2.7
695D106x003562T	SPRAGUE	10 μ F	1.3 Ω	2.5 \times 7.6 \times 2.5
TPSC475K035R0600	AVX	4.7 μ F	0.6 Ω	2.6 \times 6.0 \times 3.2

† Size is in mm. ESR is maximum resistance in Ohms at 100 kHz and $T_A = 25^\circ\text{C}$. Contact manufacturer for minimum ESR values.

APPLICATION INFORMATION

output voltage programming

The output voltage of the TPS76901 adjustable regulator is programmed using an external resistor divider as shown in Figure 22. The output voltage is calculated using:

$$V_O = V_{\text{ref}} \times \left(1 + \frac{R1}{R2}\right) \quad (1)$$

Where:

$$V_{\text{ref}} = 1.224 \text{ V typ (the internal reference voltage)}$$

Resistors R1 and R2 should be chosen for approximately 7- μA divider current. Lower value resistors can be used but offer no inherent advantage and waste more power. Higher values should be avoided as leakage currents at FB increase the output voltage error. The recommended design procedure is to choose $R2 = 169 \text{ k}\Omega$ to set the divider current at 7 μA and then calculate R1 using:

$$R1 = \left(\frac{V_O}{V_{\text{ref}}} - 1\right) \times R2 \quad (2)$$

**OUTPUT VOLTAGE
PROGRAMMING GUIDE**

OUTPUT VOLTAGE (V)	DIVIDER RESISTANCE (k Ω) [‡]	
	R1	R2
2.5	174	169
3.3	287	169
3.6	324	169
4.0	383	169
5.0	523	169

[‡] 1% values shown.

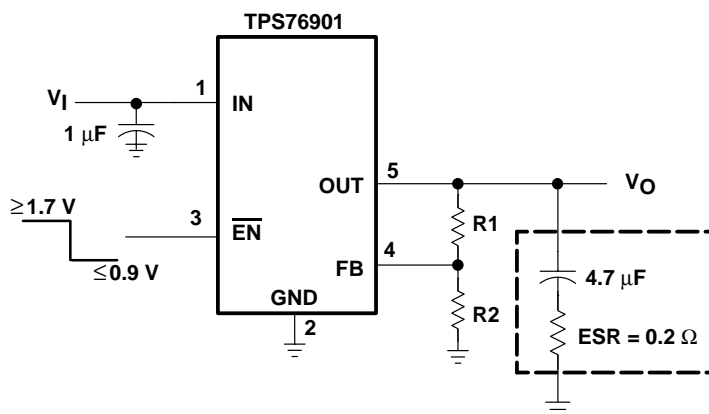

Figure 22. TPS76901 Adjustable LDO Regulator Programming

APPLICATION INFORMATION

power dissipation and junction temperature

Specified regulator operation is assured to a junction temperature of 125°C; the maximum junction temperature should be restricted to 125°C under normal operating conditions. This restriction limits the power dissipation the regulator can handle in any given application. To ensure the junction temperature is within acceptable limits, calculate the maximum allowable dissipation, $P_{D(max)}$, and the actual dissipation, P_D , which must be less than or equal to $P_{D(max)}$.

The maximum-power-dissipation limit is determined using the following equation:

$$P_{D(max)} = \frac{T_{Jmax} - T_A}{R_{\theta JA}}$$

Where:

T_{Jmax} is the maximum allowable junction temperature

$R_{\theta JA}$ is the thermal resistance junction-to-ambient for the package, see the dissipation rating table.

T_A is the ambient temperature.

The regulator dissipation is calculated using:

$$P_D = (V_I - V_O) \times I_O$$

Power dissipation resulting from quiescent current is negligible. Excessive power dissipation will trigger the thermal protection circuit.

regulator protection

The TPS769xx PMOS-pass transistor has a built-in back diode that conducts reverse current when the input voltage drops below the output voltage (e.g., during power down). Current is conducted from the output to the input and is not internally limited. If extended reverse voltage operation is anticipated, external limiting might be appropriate.

The TPS769xx features internal current limiting and thermal protection. During normal operation, the TPS769xx limits output current to approximately 350 mA. When current limiting engages, the output voltage scales back linearly until the overcurrent condition ends. While current limiting is designed to prevent gross device failure, care should be taken not to exceed the power dissipation ratings of the package. If the temperature of the device exceeds approximately 165°C, thermal-protection circuitry shuts it down. Once the device has cooled down to below approximately 140°C, regulator operation resumes.

TPS76901-Q1, TPS76912-Q1, TPS76915-Q1, TPS76918-Q1, TPS76925-Q1
 TPS76927-Q1, TPS76928-Q1, TPS76930-Q1, TPS76933-Q1, TPS76950-Q1
 ULTRALOW-POWER 100-mA LOW-DROPOUT LINEAR REGULATORS

SGLS118A – DECEMBER 2001 – REVISED JANUARY 2002

MECHANICAL DATA

DBV (R-PDSO-G5)

PLASTIC SMALL-OUTLINE

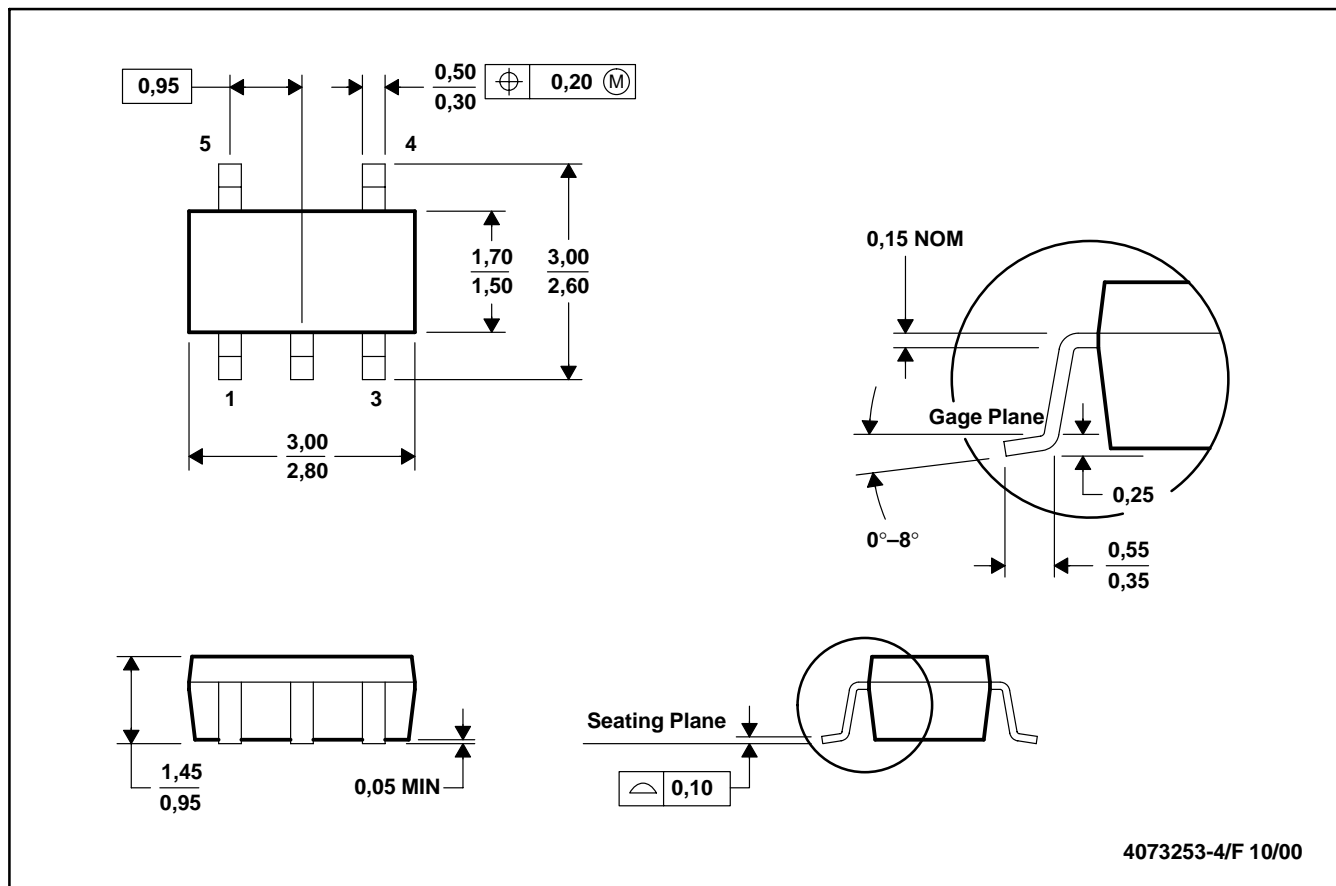

- NOTES:
- All linear dimensions are in millimeters.
 - This drawing is subject to change without notice.
 - Body dimensions do not include mold flash or protrusion.
 - Falls within JEDEC MO-178

IMPORTANT NOTICE

Texas Instruments Incorporated and its subsidiaries (TI) reserve the right to make corrections, modifications, enhancements, improvements, and other changes to its products and services at any time and to discontinue any product or service without notice. Customers should obtain the latest relevant information before placing orders and should verify that such information is current and complete. All products are sold subject to TI's terms and conditions of sale supplied at the time of order acknowledgment.

TI warrants performance of its hardware products to the specifications applicable at the time of sale in accordance with TI's standard warranty. Testing and other quality control techniques are used to the extent TI deems necessary to support this warranty. Except where mandated by government requirements, testing of all parameters of each product is not necessarily performed.

TI assumes no liability for applications assistance or customer product design. Customers are responsible for their products and applications using TI components. To minimize the risks associated with customer products and applications, customers should provide adequate design and operating safeguards.

TI does not warrant or represent that any license, either express or implied, is granted under any TI patent right, copyright, mask work right, or other TI intellectual property right relating to any combination, machine, or process in which TI products or services are used. Information published by TI regarding third-party products or services does not constitute a license from TI to use such products or services or a warranty or endorsement thereof. Use of such information may require a license from a third party under the patents or other intellectual property of the third party, or a license from TI under the patents or other intellectual property of TI.

Reproduction of information in TI data books or data sheets is permissible only if reproduction is without alteration and is accompanied by all associated warranties, conditions, limitations, and notices. Reproduction of this information with alteration is an unfair and deceptive business practice. TI is not responsible or liable for such altered documentation.

Resale of TI products or services with statements different from or beyond the parameters stated by TI for that product or service voids all express and any implied warranties for the associated TI product or service and is an unfair and deceptive business practice. TI is not responsible or liable for any such statements.

Mailing Address:

Texas Instruments
Post Office Box 655303
Dallas, Texas 75265