

The μA78M15 is obsolete and no longer is supplied.

SLVS059N – JUNE 1976 – REVISED AUGUST 2004

- 3-Terminal Regulators
- Output Current Up To 500 mA
- No External Components
- Internal Thermal-Overload Protection
- High Power-Dissipation Capability
- Internal Short-Circuit Current Limiting
- Output Transistor Safe-Area Compensation

KC (TO-220) PACKAGE
(TOP VIEW)

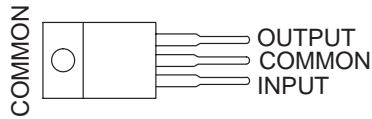

KTP (PowerFLEX™/TO-252*) PACKAGE
(TOP VIEW)

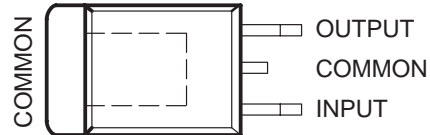

*Complies with JEDEC TO-252, variation AC

KCS (TO-220) PACKAGE
(TOP VIEW)

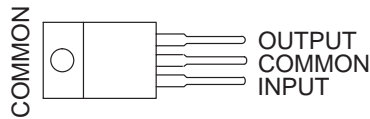

DCY (SOT-223) PACKAGE
(TOP VIEW)

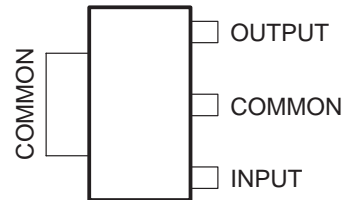

description/ordering information

This series of fixed-voltage integrated-circuit voltage regulators is designed for a wide range of applications. These applications include on-card regulation for elimination of noise and distribution problems associated with single-point regulation. Each of these regulators can deliver up to 500 mA of output current. The internal current-limiting and thermal-shutdown features of these regulators essentially make them immune to overload. In addition to use as fixed-voltage regulators, these devices can be used with external components to obtain adjustable output voltages and currents and also as the power-pass element in precision regulators.



Please be aware that an important notice concerning availability, standard warranty, and use in critical applications of Texas Instruments semiconductor products and disclaimers thereto appears at the end of this data sheet.

PowerFLEX is a trademark of Texas Instruments.

PRODUCTION DATA information is current as of publication date. Products conform to specifications per the terms of Texas Instruments standard warranty. Production processing does not necessarily include testing of all parameters.

 **TEXAS
INSTRUMENTS**

POST OFFICE BOX 655303 • DALLAS, TEXAS 75265

Copyright © 2004, Texas Instruments Incorporated

**μA78M00 SERIES
POSITIVE-VOLTAGE REGULATORS**

The μA78M15 is obsolete and no longer is supplied.

SLVS059N – JUNE 1976 – REVISED AUGUST 2004

description/ordering information (continued)

ORDERING INFORMATION

T _J	V _{O(NOM)} (V)	PACKAGE†		ORDERABLE PART NUMBER	TOP-SIDE MARKING
0°C to 125°C	3.3	PowerFLEX/TO-252* (KTP)	Reel of 3000	μA78M33CKTPR	UA78M33C
		SOT-223 (DCY)	Tube of 80	μA78M33CDCY	C3
			Reel of 2500	μA78M33CDCYR	
	TO-220 (KC)	Tube of 50	μA78M33CKC	UA78M33C	
	5	PowerFLEX/TO-252* (KTP)	Reel of 3000	μA78M05CKTPR	UA78M05C
		SOT-223 (DCY)	Tube of 80	μA78M05CDCY	C5
			Reel of 2500	μA78M05CDCYR	
		TO-220 (KC)	Tube of 50	μA78M05CKC	UA78M05C
	TO-220, short shoulder (KCS)	Tube of 20	μA78M05CKCS		
	6	PowerFLEX/TO-252* (KTP)	Reel of 3000	μA78M06CKTPR	UA78M06C
	8	PowerFLEX/TO-252* (KTP)	Reel of 3000	μA78M08CKTPR	UA78M08C
		SOT-223 (DCY)	Tube of 80	μA78M08CDCY	C8
			Reel of 2500	μA78M08CDCYR	
	TO-220 (KC)	Tube of 50	μA78M08CKC	UA78M08C	
	9	PowerFLEX/TO-252* (KTP)	Reel of 3000	μA78M09CKTPR	UA78M09C
	10	PowerFLEX/TO-252* (KTP)	Reel of 3000	μA78M10CKTPR	UA78M10C
12	Power Flex/TO-252* (KTP)	Reel of 3000	μA78M12CKTPR	UA78M12C	
	TO-220 (KC)	Tube of 50	μA78M12CKC	UA78M12C	
-40°C to 125°C	5	PowerFLEX/TO-252* (KTP)	Reel of 3000	μA78M05IKTPR	UA78M05I
		SOT-223 (DCY)	Tube of 80	μA78M05IDCY	J5
			Reel of 2500	μA78M05IDCYR	
		TO-220 (KC)	Tube of 50	μA78M05IKC	UA78M05I
TO-220, short shoulder (KCS)	Tube of 20	μA78M05IKCS			

*Complies with TO-252, variation AC.

† Package drawings, standard packing quantities, thermal data, symbolization, and PCB design guidelines are available at www.ti.com/sc/package.



The μA78M15 is obsolete and no longer is supplied.

SLVS059N – JUNE 1976 – REVISED AUGUST 2004

schematic

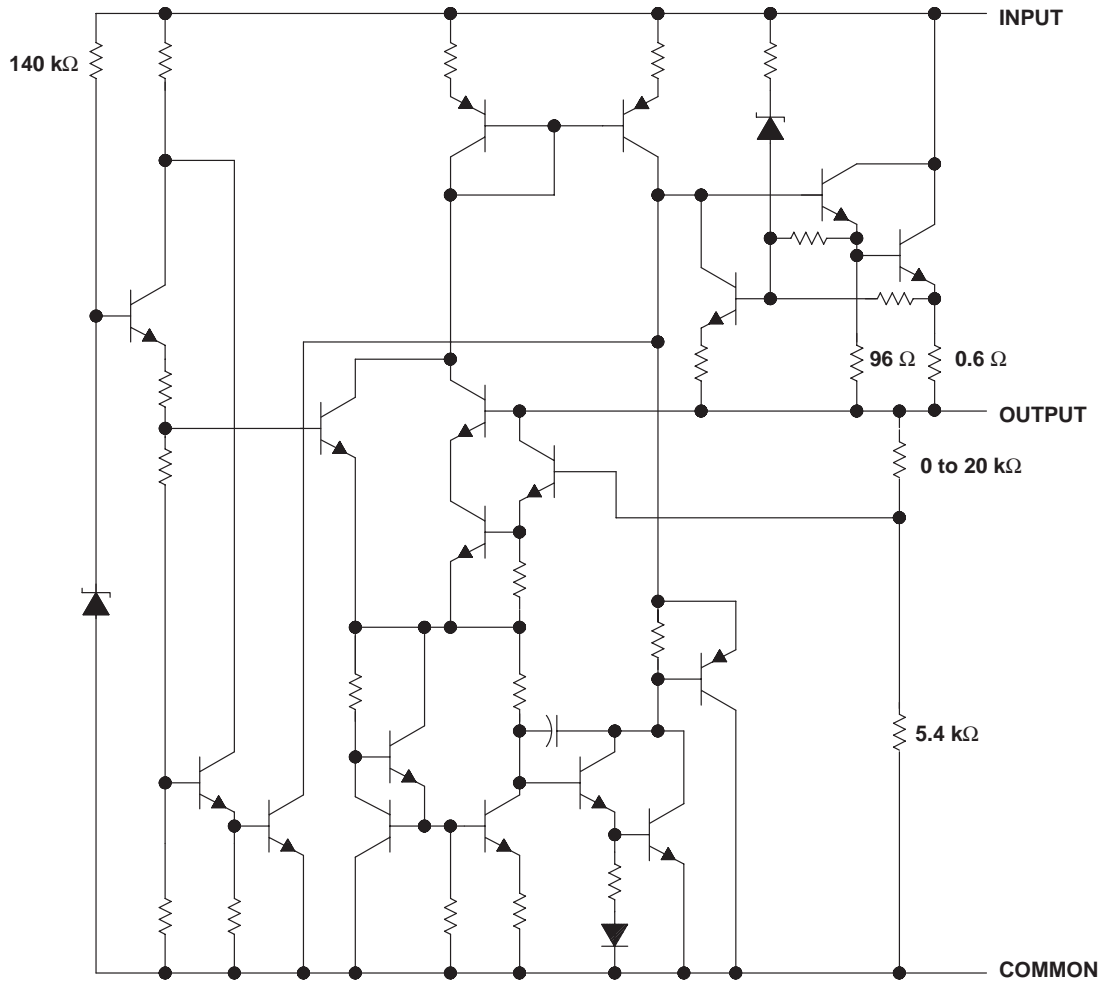

Resistor values shown are nominal.

μA78M00 SERIES POSITIVE-VOLTAGE REGULATORS

The μA78M15 is obsolete and no longer is supplied.

SLVS059N – JUNE 1976 – REVISED AUGUST 2004

absolute maximum ratings over virtual junction temperature range (unless otherwise noted)†

Input voltage, V_I	35 V
Operating virtual junction temperature, T_J	150°C
Storage temperature range, T_{stg}	-65°C to 150°C

† Stresses beyond those listed under “absolute maximum ratings” may cause permanent damage to the device. These are stress ratings only, and functional operation of the device at these or any other conditions beyond those indicated under “recommended operating conditions” is not implied. Exposure to absolute-maximum-rated conditions for extended periods may affect device reliability.

package thermal data (see Note 1)

PACKAGE	BOARD	θ_{JP}^*	θ_{JC}	θ_{JA}
PowerFLEX/TO-252 (KTP)	High K, JESD 51-5	3°C/W		28°C/W
SOT-223 (DCY)	High K, JESD 51-7		4°C/W	53°C/W
TO-220 (KC/KCS)	High K, JESD 51-5	3°C/W		19°C/W

*For packages with exposed thermal pads, such as QFN, PowerPAD, and PowerFLEX, θ_{JP} is defined as the thermal resistance between the die junction and the bottom of the exposed pad.

NOTE 1: Maximum power dissipation is a function of $T_J(\max)$, θ_{JA} , and T_A . The maximum allowable power dissipation at any allowable ambient temperature is $P_D = (T_J(\max) - T_A)/\theta_{JA}$. Operating at the absolute maximum T_J of 150°C can affect reliability.

recommended operating conditions

		MIN	MAX	UNIT	
V_I	Input voltage	μA78M33	5.3	25	V
		μA78M05	7	25	
		μA78M06	8	25	
		μA78M08	10.5	25	
		μA78M09	11.5	26	
		μA78M10	12.5	28	
		μA78M12	14.5	30	
	μA78M15	17.5	30		
I_O	Output current		500	mA	
T_J	Operating virtual junction temperature	μA78MxxC	0	125	°C
		μA78MxxI	-40	125	



The μA78M15 is obsolete and no longer is supplied.

SLVS059N – JUNE 1976 – REVISED AUGUST 2004

electrical characteristics at specified virtual junction temperature, $V_I = 8\text{ V}$, $I_O = 350\text{ mA}$, $T_J = 25^\circ\text{C}$ (unless otherwise noted)

PARAMETER	TEST CONDITIONST	μA78M33C			UNIT	
		MIN	TYP	MAX		
Output voltage‡	$I_O = 5\text{ mA to }350\text{ mA}$, $V_I = 8\text{ V to }20\text{ V}$		3.2	3.3	3.4	V
		$T_J = 0^\circ\text{C to }125^\circ\text{C}$	3.1	3.3	3.5	
Input voltage regulation	$I_O = 200\text{ mA}$	$V_I = 5.3\text{ V to }25\text{ V}$		9	100	mV
		$V_I = 8\text{ V to }25\text{ V}$		3	50	
Ripple rejection	$V_I = 8\text{ V to }18\text{ V}$, $f = 120\text{ Hz}$	$I_O = 100\text{ mA}$, $T_J = 0^\circ\text{C to }125^\circ\text{C}$	62			dB
		$I_O = 300\text{ mA}$	62	80		
Output voltage regulation	$V_I = 8\text{ V}$, $I_O = 5\text{ mA to }500\text{ mA}$		20	100	mV	
Temperature coefficient of output voltage	$I_O = 5\text{ mA}$, $T_J = 0^\circ\text{C to }125^\circ\text{C}$		-1		mV/°C	
Output noise voltage	$f = 10\text{ Hz to }100\text{ kHz}$		40	200	μV	
Dropout voltage			2		V	
Bias current			4.5	6	mA	
Bias current change	$I_O = 200\text{ mA}$, $V_I = 8\text{ V to }25\text{ V}$, $T_J = 0^\circ\text{C to }125^\circ\text{C}$			0.8	mA	
	$I_O = 5\text{ mA to }350\text{ mA}$, $T_J = 0^\circ\text{C to }125^\circ\text{C}$			0.5		
Short-circuit output current	$V_I = 35\text{ V}$		300		mA	
Peak output current			700		mA	

† All characteristics are measured with a 0.33-μF capacitor across the input and a 0.1-μF capacitor across the output. Pulse-testing techniques maintain T_J as close to T_A as possible. Thermal effects must be taken into account separately.

‡ This specification applies only for dc power dissipation permitted by absolute maximum ratings.

electrical characteristics at specified virtual junction temperature, $V_I = 10\text{ V}$, $I_O = 350\text{ mA}$, $T_J = 25^\circ\text{C}$ (unless otherwise noted)

PARAMETER	TEST CONDITIONST	μA78M05C			UNIT	
		MIN	TYP	MAX		
Output voltage	$I_O = 5\text{ mA to }350\text{ mA}$, $V_I = 7\text{ V to }20\text{ V}$		4.8	5	5.2	V
		$T_J = 0^\circ\text{C to }125^\circ\text{C}$	4.75		5.25	
Input voltage regulation	$I_O = 200\text{ mA}$	$V_I = 7\text{ V to }25\text{ V}$		3	100	mV
		$V_I = 8\text{ V to }25\text{ V}$		1	50	
Ripple rejection	$V_I = 8\text{ V to }18\text{ V}$, $f = 120\text{ Hz}$	$I_O = 100\text{ mA}$, $T_J = 0^\circ\text{C to }125^\circ\text{C}$	62			dB
		$I_O = 300\text{ mA}$	62	80		
Output voltage regulation	$I_O = 5\text{ mA to }500\text{ mA}$		20	100	mV	
	$I_O = 5\text{ mA to }200\text{ mA}$		10	50		
Temperature coefficient of output voltage	$I_O = 5\text{ mA}$, $T_J = 0^\circ\text{C to }125^\circ\text{C}$		-1		mV/°C	
Output noise voltage	$f = 10\text{ Hz to }100\text{ kHz}$		40	200	μV	
Dropout voltage			2		V	
Bias current			4.5	6	mA	
Bias current change	$I_O = 200\text{ mA}$, $V_I = 8\text{ V to }25\text{ V}$, $T_J = 0^\circ\text{C to }125^\circ\text{C}$			0.8	mA	
	$I_O = 5\text{ mA to }350\text{ mA}$, $T_J = 0^\circ\text{C to }125^\circ\text{C}$			0.5		
Short-circuit output current	$V_I = 35\text{ V}$		300		mA	
Peak output current			0.7		A	

† All characteristics are measured with a 0.33-μF capacitor across the input and a 0.1-μF capacitor across the output. Pulse-testing techniques maintain T_J as close to T_A as possible. Thermal effects must be taken into account separately.

μA78M00 SERIES POSITIVE-VOLTAGE REGULATORS

The μA78M15 is obsolete and no longer is supplied.

SLVS059N – JUNE 1976 – REVISED AUGUST 2004

electrical characteristics at specified virtual junction temperature, $V_I = 10\text{ V}$, $I_O = 350\text{ mA}$, $T_J = 25^\circ\text{C}$ (unless otherwise noted)

PARAMETER	TEST CONDITIONS†	μA78M05I			UNIT	
		MIN	TYP	MAX		
Output voltage	$I_O = 5\text{ mA to }350\text{ mA}$, $V_I = 7\text{ V to }20\text{ V}$		4.8	5	5.2	V
		$T_J = -40^\circ\text{C to }125^\circ\text{C}$	4.75		5.25	
Input voltage regulation	$I_O = 200\text{ mA}$	$V_I = 7\text{ V to }25\text{ V}$		3	100	mV
		$V_I = 8\text{ V to }25\text{ V}$		1	50	
Ripple rejection	$V_I = 8\text{ V to }18\text{ V}$, $f = 120\text{ Hz}$	$I_O = 100\text{ mA}$, $T_J = -40^\circ\text{C to }125^\circ\text{C}$	62			dB
		$I_O = 300\text{ mA}$	62	80		
Output voltage regulation	$I_O = 5\text{ mA to }500\text{ mA}$		20	100	mV	
	$I_O = 5\text{ mA to }200\text{ mA}$		10	50		
Temperature coefficient of output voltage	$I_O = 5\text{ mA}$, $T_J = -40^\circ\text{C to }125^\circ\text{C}$		-1		mV/°C	
Output noise voltage	$f = 10\text{ Hz to }100\text{ kHz}$		40	200	μV	
Dropout voltage			2		V	
Bias current			4.5	6	mA	
Bias current change	$I_O = 200\text{ mA}$, $V_I = 8\text{ V to }25\text{ V}$, $T_J = -40^\circ\text{C to }125^\circ\text{C}$			0.8	mA	
	$I_O = 5\text{ mA to }350\text{ mA}$, $T_J = -40^\circ\text{C to }125^\circ\text{C}$			0.5		
Short-circuit output current	$V_I = 35\text{ V}$		300		mA	
Peak output current			0.7		A	

† All characteristics are measured with a 0.33-μF capacitor across the input and a 0.1-μF capacitor across the output. Pulse-testing techniques maintain T_J as close to T_A as possible. Thermal effects must be taken into account separately.

electrical characteristics at specified virtual junction temperature, $V_I = 11\text{ V}$, $I_O = 350\text{ mA}$, $T_J = 25^\circ\text{C}$ (unless otherwise noted)

PARAMETER	TEST CONDITIONS†	μA78M06C			UNIT	
		MIN	TYP	MAX		
Output voltage	$I_O = 5\text{ mA to }350\text{ mA}$, $V_I = 8\text{ V to }21\text{ V}$		5.75	6	6.25	V
		$T_J = 0^\circ\text{C to }125^\circ\text{C}$	5.7		6.3	
Input voltage regulation	$I_O = 200\text{ mA}$	$V_I = 8\text{ V to }25\text{ V}$		5	100	mV
		$V_I = 9\text{ V to }25\text{ V}$		1.5	50	
Ripple rejection	$V_I = 9\text{ V to }19\text{ V}$, $f = 120\text{ Hz}$	$I_O = 100\text{ mA}$, $T_J = 0^\circ\text{C to }125^\circ\text{C}$	59			dB
		$I_O = 300\text{ mA}$	59	80		
Output voltage regulation	$I_O = 5\text{ mA to }500\text{ mA}$		20	120	mV	
	$I_O = 5\text{ mA to }200\text{ mA}$		10	60		
Temperature coefficient of output voltage	$I_O = 5\text{ mA}$, $T_J = 0^\circ\text{C to }125^\circ\text{C}$		-1		mV/°C	
Output noise voltage	$f = 10\text{ Hz to }100\text{ kHz}$		45		μV	
Dropout voltage			2		V	
Bias current			4.5	6	mA	
Bias current change	$V_I = 9\text{ V to }25\text{ V}$, $I_O = 200\text{ mA}$, $T_J = 0^\circ\text{C to }125^\circ\text{C}$			0.8	mA	
	$I_O = 5\text{ mA to }350\text{ mA}$, $T_J = 0^\circ\text{C to }125^\circ\text{C}$			0.5		
Short-circuit output current	$V_I = 35\text{ V}$		270		mA	
Peak output current			0.7		A	

† All characteristics are measured with a 0.33-μF capacitor across the input and a 0.1-μF capacitor across the output. Pulse-testing techniques maintain T_J as close to T_A as possible. Thermal effects must be taken into account separately.



The μA78M15 is obsolete and no longer is supplied.

SLVS059N – JUNE 1976 – REVISED AUGUST 2004

electrical characteristics at specified virtual junction temperature, $V_I = 14\text{ V}$, $I_O = 350\text{ mA}$, $T_J = 25^\circ\text{C}$ (unless otherwise noted)

PARAMETER	TEST CONDITIONST		μA78M08C			UNIT
			MIN	TYP	MAX	
Output voltage	$V_I = 10.5\text{ V to }23\text{ V}$, $I_O = 5\text{ mA to }350\text{ mA}$	$T_J = 0^\circ\text{C to }125^\circ\text{C}$	7.7	8	8.3	V
			7.6		8.4	
Input voltage regulation	$I_O = 200\text{ mA}$	$V_I = 10.5\text{ V to }25\text{ V}$		6	100	mV
		$V_I = 11\text{ V to }25\text{ V}$		2	50	
Ripple rejection	$V_I = 11.5\text{ V to }21.5\text{ V}$, $f = 120\text{ Hz}$	$I_O = 100\text{ mA}$, $T_J = 0^\circ\text{C to }125^\circ\text{C}$	56			dB
		$I_O = 300\text{ mA}$	56	80		
Output voltage regulation	$I_O = 5\text{ mA to }500\text{ mA}$			25	160	mV
	$I_O = 5\text{ mA to }200\text{ mA}$			10	80	
Temperature coefficient of output voltage	$I_O = 5\text{ mA}$,	$T_J = 0^\circ\text{C to }125^\circ\text{C}$		-1		mV/°C
Output noise voltage	$f = 10\text{ Hz to }100\text{ kHz}$			52		μV
Dropout voltage				2		V
Bias current				4.6	6	mA
Bias current change	$V_I = 10.5\text{ V to }25\text{ V}$,	$I_O = 200\text{ mA}$,	$T_J = 0^\circ\text{C to }125^\circ\text{C}$		0.8	mA
	$I_O = 5\text{ mA to }350\text{ mA}$,	$T_J = 0^\circ\text{C to }125^\circ\text{C}$			0.5	
Short-circuit output current	$V_I = 35\text{ V}$			250		mA
Peak output current				0.7		A

† All characteristics are measured with a 0.33-μF capacitor across the input and a 0.1-μF capacitor across the output. Pulse-testing techniques maintain T_J as close to T_A as possible. Thermal effects must be taken into account separately.

electrical characteristics at specified virtual junction temperature, $V_I = 16\text{ V}$, $I_O = 350\text{ mA}$, $T_J = 25^\circ\text{C}$ (unless otherwise noted)

PARAMETER	TEST CONDITIONST		μA78M09C			UNIT
			MIN	TYP	MAX	
Output voltage	$V_I = 11.5\text{ V to }24\text{ V}$, $I_O = 5\text{ mA to }350\text{ mA}$	$T_J = 0^\circ\text{C to }125^\circ\text{C}$	8.6	9	9.4	V
			8.5		9.5	
Input voltage regulation	$I_O = 200\text{ mA}$	$V_I = 11.5\text{ V to }26\text{ V}$		6	100	mV
		$V_I = 12\text{ V to }26\text{ V}$		2	50	
Ripple rejection	$V_I = 13\text{ V to }23\text{ V}$, $f = 120\text{ Hz}$	$I_O = 100\text{ mA}$, $T_J = 0^\circ\text{C to }125^\circ\text{C}$	56			dB
		$I_O = 300\text{ mA}$	56	80		
Output voltage regulation	$I_O = 5\text{ mA to }500\text{ mA}$			25	180	mV
	$I_O = 5\text{ mA to }200\text{ mA}$			10	90	
Temperature coefficient of output voltage	$I_O = 5\text{ mA}$,	$T_J = 0^\circ\text{C to }125^\circ\text{C}$		-1		mV/°C
Output noise voltage	$f = 10\text{ Hz to }100\text{ kHz}$			58		μV
Dropout voltage				2		V
Bias current				4.6	6	mA
Bias current change	$V_I = 11.5\text{ V to }26\text{ V}$,	$I_O = 200\text{ mA}$,	$T_J = 0^\circ\text{C to }125^\circ\text{C}$		0.8	mA
	$I_O = 5\text{ mA to }350\text{ mA}$,	$T_J = 0^\circ\text{C to }125^\circ\text{C}$			0.5	
Short-circuit output current	$V_I = 35\text{ V}$			250		mA
Peak output current				0.7		A

† All characteristics are measured with a 0.33-μF capacitor across the input and a 0.1-μF capacitor across the output. Pulse-testing techniques maintain T_J as close to T_A as possible. Thermal effects must be taken into account separately.

μA78M00 SERIES POSITIVE-VOLTAGE REGULATORS

The μA78M15 is obsolete and no longer is supplied.

SLVS059N – JUNE 1976 – REVISED AUGUST 2004

electrical characteristics at specified virtual junction temperature, $V_I = 17\text{ V}$, $I_O = 350\text{ mA}$, $T_J = 25^\circ\text{C}$ (unless otherwise noted)

PARAMETER	TEST CONDITIONS†		μA78M10C			UNIT
			MIN	TYP	MAX	
Output voltage	$V_I = 12.5\text{ V to }25\text{ V}$, $I_O = 5\text{ mA to }350\text{ mA}$		9.6	10	10.4	V
		$T_J = 0^\circ\text{C to }125^\circ\text{C}$	9.5		10.5	
Input voltage regulation	$I_O = 200\text{ mA}$	$V_I = 12.5\text{ V to }28\text{ V}$		7	100	mV
		$V_I = 14\text{ V to }28\text{ V}$		2	50	
Ripple rejection	$V_I = 15\text{ V to }25\text{ V}$, $f = 120\text{ Hz}$	$I_O = 100\text{ mA}$, $T_J = 0^\circ\text{C to }125^\circ\text{C}$	59			dB
		$I_O = 300\text{ mA}$	55	80		
Output voltage regulation	$I_O = 5\text{ mA to }500\text{ mA}$		25	200	mV	
	$I_O = 5\text{ mA to }200\text{ mA}$		10	100		
Temperature coefficient of output voltage	$I_O = 5\text{ mA}$, $T_J = 0^\circ\text{C to }125^\circ\text{C}$		-1		mV/°C	
Output noise voltage	$f = 10\text{ Hz to }100\text{ kHz}$		64		μV	
Dropout voltage			2		V	
Bias current			4.7	6	mA	
Bias current change	$V_I = 12.5\text{ V to }28\text{ V}$, $I_O = 200\text{ mA}$, $T_J = 0^\circ\text{C to }125^\circ\text{C}$			0.8	mA	
	$I_O = 5\text{ mA to }350\text{ mA}$, $T_J = 0^\circ\text{C to }125^\circ\text{C}$			0.5		
Short-circuit output current	$V_I = 35\text{ V}$		245		mA	
Peak output current			0.7		A	

† All characteristics are measured with a 0.33-μF capacitor across the input and a 0.1-μF capacitor across the output. Pulse-testing techniques maintain T_J as close to T_A as possible. Thermal effects must be taken into account separately.

electrical characteristics at specified virtual junction temperature, $V_I = 19\text{ V}$, $I_O = 350\text{ mA}$, $T_J = 25^\circ\text{C}$ (unless otherwise noted)

PARAMETER	TEST CONDITIONS†		μA78M12C			UNIT
			MIN	TYP	MAX	
Output voltage	$V_I = 14.5\text{ V to }27\text{ V}$, $I_O = 5\text{ mA to }350\text{ mA}$		11.5	12	12.5	V
		$T_J = 0^\circ\text{C to }125^\circ\text{C}$	11.4		12.6	
Input voltage regulation	$I_O = 200\text{ mA}$	$V_I = 14.5\text{ V to }30\text{ V}$		8	100	mV
		$V_I = 16\text{ V to }30\text{ V}$		2	50	
Ripple rejection	$V_I = 15\text{ V to }25\text{ V}$, $f = 120\text{ Hz}$	$I_O = 100\text{ mA}$, $T_J = 0^\circ\text{C to }125^\circ\text{C}$	55			dB
		$I_O = 300\text{ mA}$	55	80		
Output voltage regulation	$I_O = 5\text{ mA to }500\text{ mA}$		25	240	mV	
	$I_O = 5\text{ mA to }200\text{ mA}$		10	120		
Temperature coefficient of output voltage	$I_O = 5\text{ mA}$		-1		mV/°C	
Output noise voltage	$f = 10\text{ Hz to }100\text{ kHz}$		75		μV	
Dropout voltage			2		V	
Bias current			4.8	6	mA	
Bias current change	$V_I = 14.5\text{ V to }30\text{ V}$, $I_O = 200\text{ mA}$, $T_J = 0^\circ\text{C to }125^\circ\text{C}$			0.8	mA	
	$I_O = 5\text{ mA to }350\text{ mA}$, $T_J = 0^\circ\text{C to }125^\circ\text{C}$			0.5		
Short-circuit output current	$V_I = 35\text{ V}$		240		mA	
Peak output current			0.7		A	

† All characteristics are measured with a 0.33-μF capacitor across the input and a 0.1-μF capacitor across the output. Pulse-testing techniques maintain T_J as close to T_A as possible. Thermal effects must be taken into account separately.



The μA78M15 is obsolete and no longer is supplied.

SLVS059N – JUNE 1976 – REVISED AUGUST 2004

electrical characteristics at specified virtual junction temperature, $V_I = 23\text{ V}$, $I_O = 350\text{ mA}$, $T_J = 25^\circ\text{C}$ (unless otherwise noted)

PARAMETER	TEST CONDITIONST		μA78M15C			UNIT
			MIN	TYP	MAX	
Output voltage	$V_I = 17.5\text{ V to }30\text{ V}$, $I_O = 5\text{ mA to }350\text{ mA}$	$T_J = 0^\circ\text{C to }125^\circ\text{C}$	14.4	15	15.6	V
			14.25		15.75	
Input voltage regulation	$I_O = 200\text{ mA}$	$V_I = 17.5\text{ V to }30\text{ V}$		10	100	mV
		$V_I = 20\text{ V to }30\text{ V}$		3	50	
Ripple rejection	$V_I = 18.5\text{ V to }28.5\text{ V}$, $f = 120\text{ Hz}$	$I_O = 100\text{ mA, }300\text{ mA}$, $T_J = 0^\circ\text{C to }125^\circ\text{C}$	54			dB
			54	70		
Output voltage regulation	$I_O = 5\text{ mA to }500\text{ mA}$		25	300		mV
	$I_O = 5\text{ mA to }200\text{ mA}$		10	150		
Temperature coefficient of output voltage	$I_O = 5\text{ mA}$,	$T_J = 0^\circ\text{C to }125^\circ\text{C}$		-1		mV/°C
Output noise voltage	$f = 10\text{ Hz to }100\text{ kHz}$		90			μV
Dropout voltage			2			V
Bias current			4.8	6		mA
Bias current change	$V_I = 17.5\text{ V to }30\text{ V}$, $I_O = 200\text{ mA}$, $T_J = 0^\circ\text{C to }125^\circ\text{C}$				0.8	mA
	$I_O = 5\text{ mA to }350\text{ mA}$, $T_J = 0^\circ\text{C to }125^\circ\text{C}$				0.5	
Short-circuit output current	$V_I = 35\text{ V}$		240			mA
Peak output current			0.7			A

† All characteristics are measured with a 0.33-μF capacitor across the input and a 0.1-μF capacitor across the output. Pulse-testing techniques maintain T_J as close to T_A as possible. Thermal effects must be taken into account separately.

PACKAGING INFORMATION

Orderable Device	Status ⁽¹⁾	Package Type	Package Drawing	Pins	Package Qty	Eco Plan ⁽²⁾	Lead/Ball Finish	MSL Peak Temp ⁽³⁾
UA78M05CDCY	ACTIVE	SOT-223	DCY	4	80	None	Call TI	Level-2-235C-1 YEAR
UA78M05CDCYR	ACTIVE	SOT-223	DCY	4	2500	None	Call TI	Level-2-235C-1 YEAR
UA78M05CKC	ACTIVE	TO-220	KC	3	50	None	Call TI	Level-1-220C-UNLIM
UA78M05CKCS	ACTIVE	TO-220	KCS	3	50	None	Call TI	Level-NC-NC-NC
UA78M05CKTPR	ACTIVE	PFM	KTP	2	3000	None	Call TI	Level-1-220C-UNLIM
UA78M05IDCY	ACTIVE	SOT-223	DCY	4	80	None	CU	Level-2-235C-1 YEAR
UA78M05IDCYR	ACTIVE	SOT-223	DCY	4	2500	None	CU	Level-2-235C-1 YEAR
UA78M05IKC	ACTIVE	TO-220	KC	3	50	None	Call TI	Level-1-220C-UNLIM
UA78M05IKCS	ACTIVE	TO-220	KCS	3	50	None	Call TI	Level-NC-NC-NC
UA78M05IKTPR	ACTIVE	PFM	KTP	2	3000	None	Call TI	Level-1-220C-UNLIM
UA78M06CKC	OBSOLETE	TO-220	KC	3		None	Call TI	Call TI
UA78M06CKTPR	ACTIVE	PFM	KTP	2	3000	None	Call TI	Level-1-220C-UNLIM
UA78M08CDCY	ACTIVE	SOT-223	DCY	4	80	None	Call TI	Level-2-235C-1 YEAR
UA78M08CDCYR	ACTIVE	SOT-223	DCY	4	2500	None	Call TI	Level-2-235C-1 YEAR
UA78M08CKC	ACTIVE	TO-220	KC	3	50	None	Call TI	Level-1-220C-UNLIM
UA78M08CKCS	ACTIVE	TO-220	KCS	3	50	None	CU SNPB	Level-NC-NC-NC
UA78M08CKTPR	ACTIVE	PFM	KTP	2	3000	None	Call TI	Level-1-220C-UNLIM
UA78M09CKC	OBSOLETE	TO-220	KC	3		None	Call TI	Call TI
UA78M09CKTP	OBSOLETE	PFM	KTP	2		None	Call TI	Call TI
UA78M09CKTPR	ACTIVE	PFM	KTP	2	3000	None	Call TI	Level-1-220C-UNLIM
UA78M10CKC	OBSOLETE	TO-220	KC	3		None	Call TI	Call TI
UA78M10CKTPR	ACTIVE	PFM	KTP	2	3000	None	Call TI	Level-1-220C-UNLIM
UA78M12CKC	ACTIVE	TO-220	KC	3	50	None	Call TI	Level-1-220C-UNLIM
UA78M12CKCS	ACTIVE	TO-220	KCS	3	50	None	CU SNPB	Level-NC-NC-NC
UA78M12CKTPR	ACTIVE	PFM	KTP	2	3000	None	Call TI	Level-1-220C-UNLIM
UA78M15CKC	OBSOLETE	TO-220	KC	3		None	Call TI	Call TI
UA78M15CKTPR	OBSOLETE	PFM	KTP	2		None	Call TI	Call TI
UA78M20CKC	OBSOLETE	TO-220	KC	3		None	Call TI	Call TI
UA78M20CKTPR	OBSOLETE	PFM	KTP	2		None	Call TI	Call TI
UA78M20Y	OBSOLETE	XCEPT	Y	0		None	Call TI	Call TI
UA78M24CKTPR	OBSOLETE	PFM	KTP	2		None	Call TI	Call TI
UA78M33CDCY	ACTIVE	SOT-223	DCY	4	80	None	Call TI	Level-2-235C-1 YEAR
UA78M33CDCYR	ACTIVE	SOT-223	DCY	4	2500	None	Call TI	Level-2-235C-1 YEAR
UA78M33CKC	ACTIVE	TO-220	KC	3	50	None	Call TI	Level-1-220C-UNLIM
UA78M33CKCS	ACTIVE	TO-220	KCS	3	50	None	CU SNPB	Level-NC-NC-NC
UA78M33CKTPR	ACTIVE	PFM	KTP	2	3000	None	Call TI	Level-1-220C-UNLIM

⁽¹⁾ The marketing status values are defined as follows:

ACTIVE: Product device recommended for new designs.

LIFEBUY: TI has announced that the device will be discontinued, and a lifetime-buy period is in effect.

NRND: Not recommended for new designs. Device is in production to support existing customers, but TI does not recommend using this part in a new design.

PREVIEW: Device has been announced but is not in production. Samples may or may not be available.

OBSOLETE: TI has discontinued the production of the device.

(2) Eco Plan - May not be currently available - please check <http://www.ti.com/productcontent> for the latest availability information and additional product content details.

None: Not yet available Lead (Pb-Free).

Pb-Free (RoHS): TI's terms "Lead-Free" or "Pb-Free" mean semiconductor products that are compatible with the current RoHS requirements for all 6 substances, including the requirement that lead not exceed 0.1% by weight in homogeneous materials. Where designed to be soldered at high temperatures, TI Pb-Free products are suitable for use in specified lead-free processes.

Green (RoHS & no Sb/Br): TI defines "Green" to mean "Pb-Free" and in addition, uses package materials that do not contain halogens, including bromine (Br) or antimony (Sb) above 0.1% of total product weight.

(3) MSL, Peak Temp. -- The Moisture Sensitivity Level rating according to the JEDEC industry standard classifications, and peak solder temperature.

Important Information and Disclaimer: The information provided on this page represents TI's knowledge and belief as of the date that it is provided. TI bases its knowledge and belief on information provided by third parties, and makes no representation or warranty as to the accuracy of such information. Efforts are underway to better integrate information from third parties. TI has taken and continues to take reasonable steps to provide representative and accurate information but may not have conducted destructive testing or chemical analysis on incoming materials and chemicals. TI and TI suppliers consider certain information to be proprietary, and thus CAS numbers and other limited information may not be available for release.

In no event shall TI's liability arising out of such information exceed the total purchase price of the TI part(s) at issue in this document sold by TI to Customer on an annual basis.

DCY (R-PDSO-G4)

PLASTIC SMALL-OUTLINE

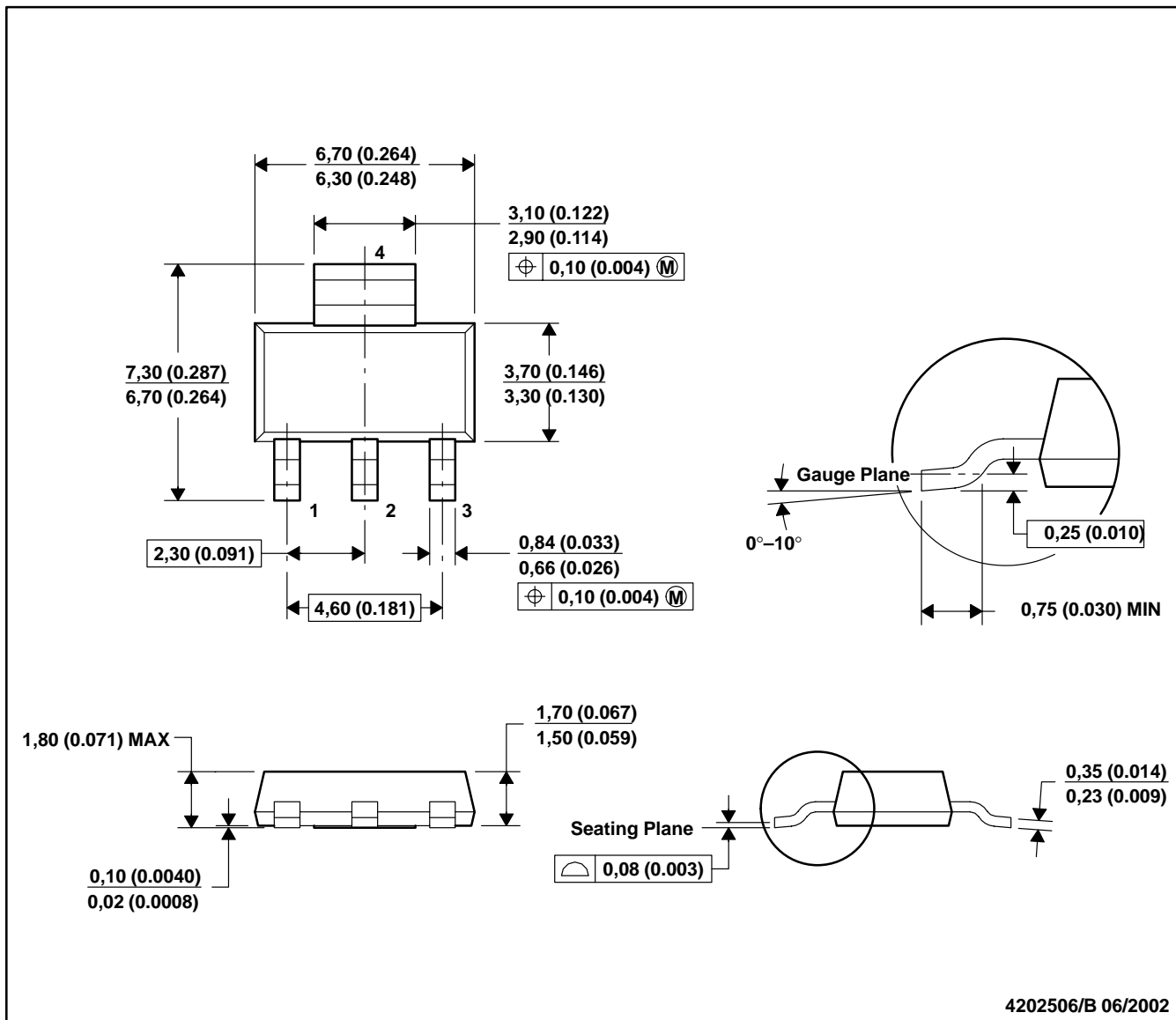

- NOTES: A. All linear dimensions are in millimeters (inches).
 B. This drawing is subject to change without notice.
 C. Body dimensions do not include mold flash or protrusion.
 D. Falls within JEDEC TO-261 Variation AA.

KTP (R-PSFM-G2)

PowerFLEX™ PLASTIC FLANGE-MOUNT PACKAGE

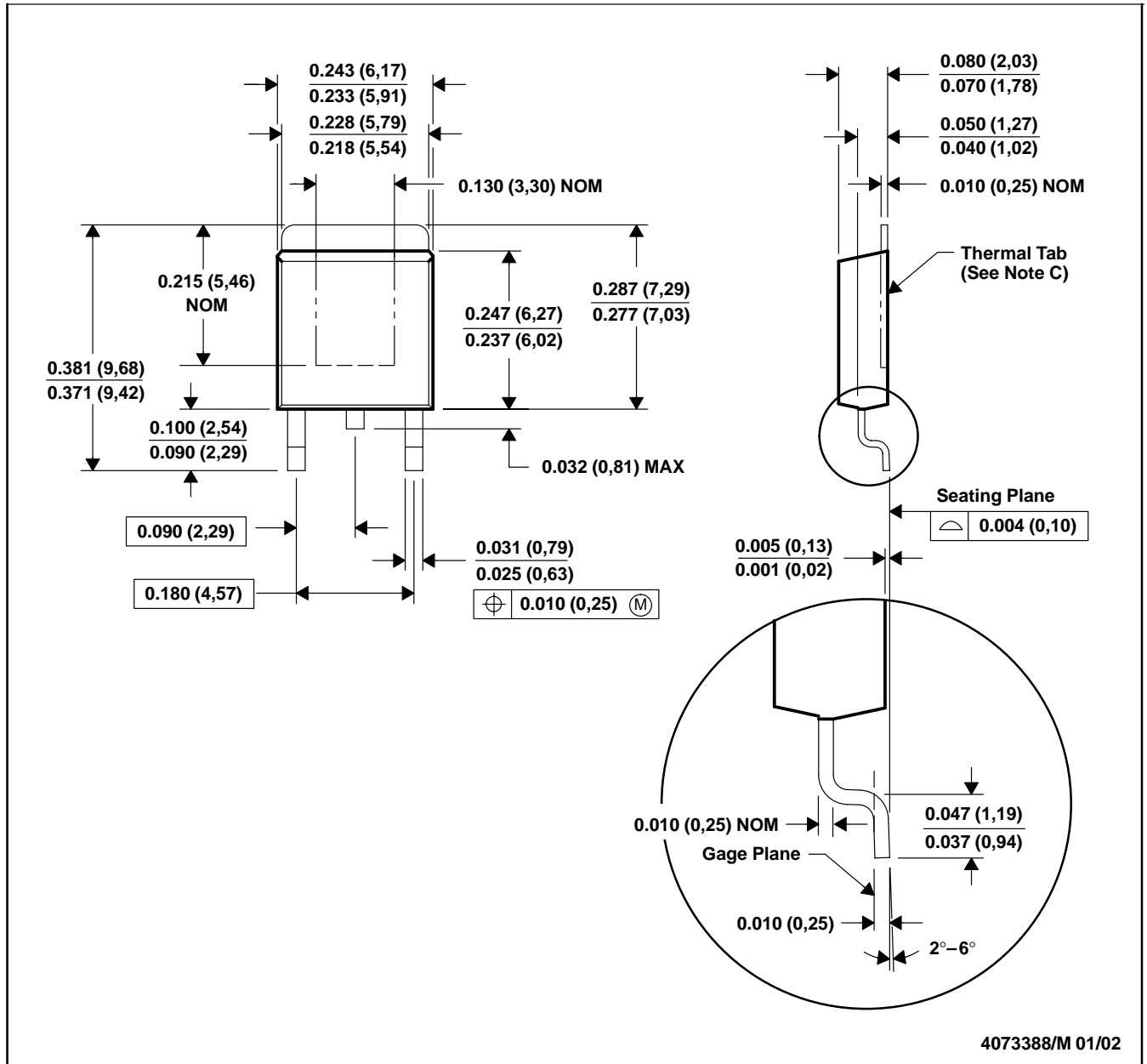

- NOTES: A. All linear dimensions are in inches (millimeters).
 B. This drawing is subject to change without notice.
 C. The center lead is in electrical contact with the thermal tab.
 D. Dimensions do not include mold protrusions, not to exceed 0.006 (0,15).
 E. Falls within JEDEC TO-252 variation AC.

PowerFLEX is a trademark of Texas Instruments.

KCS (R-PSFM-T3)

PLASTIC FLANGE-MOUNT PACKAGE

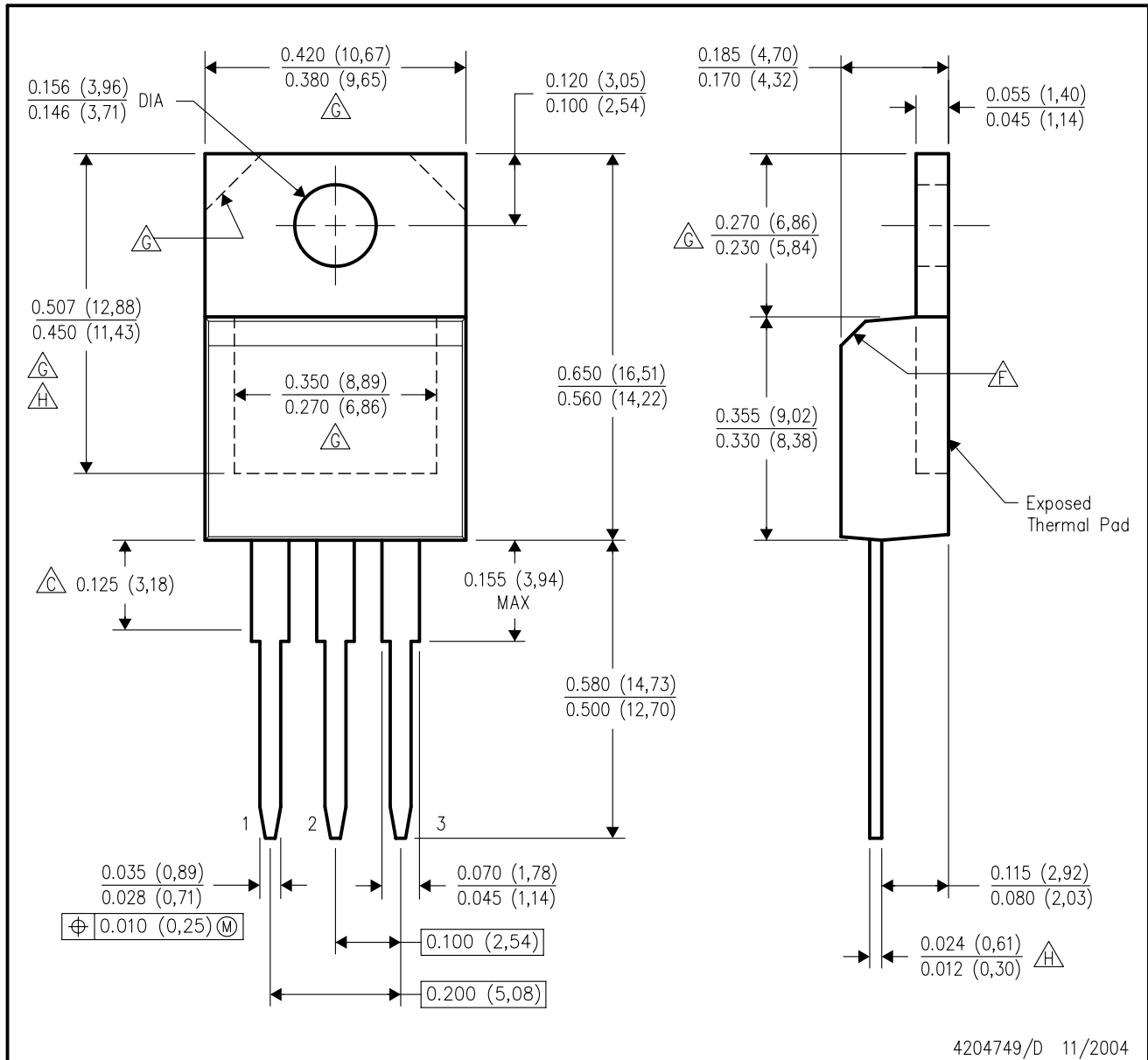

- NOTES:
- A. All linear dimensions are in inches (millimeters).
 - B. This drawing is subject to change without notice.
 - C. Lead dimensions are not controlled within this area.
 - D. All lead dimensions apply before solder dip.
 - E. The center lead is in electrical contact with the mounting tab.
 - F. The chamfer is optional.
 - G. Thermal pad contour optional within these dimensions.
 - H. Falls within JEDEC TO-220 variation AB, except minimum lead thickness and minimum exposed pad length.

IMPORTANT NOTICE

Texas Instruments Incorporated and its subsidiaries (TI) reserve the right to make corrections, modifications, enhancements, improvements, and other changes to its products and services at any time and to discontinue any product or service without notice. Customers should obtain the latest relevant information before placing orders and should verify that such information is current and complete. All products are sold subject to TI's terms and conditions of sale supplied at the time of order acknowledgment.

TI warrants performance of its hardware products to the specifications applicable at the time of sale in accordance with TI's standard warranty. Testing and other quality control techniques are used to the extent TI deems necessary to support this warranty. Except where mandated by government requirements, testing of all parameters of each product is not necessarily performed.

TI assumes no liability for applications assistance or customer product design. Customers are responsible for their products and applications using TI components. To minimize the risks associated with customer products and applications, customers should provide adequate design and operating safeguards.

TI does not warrant or represent that any license, either express or implied, is granted under any TI patent right, copyright, mask work right, or other TI intellectual property right relating to any combination, machine, or process in which TI products or services are used. Information published by TI regarding third-party products or services does not constitute a license from TI to use such products or services or a warranty or endorsement thereof. Use of such information may require a license from a third party under the patents or other intellectual property of the third party, or a license from TI under the patents or other intellectual property of TI.

Reproduction of information in TI data books or data sheets is permissible only if reproduction is without alteration and is accompanied by all associated warranties, conditions, limitations, and notices. Reproduction of this information with alteration is an unfair and deceptive business practice. TI is not responsible or liable for such altered documentation.

Resale of TI products or services with statements different from or beyond the parameters stated by TI for that product or service voids all express and any implied warranties for the associated TI product or service and is an unfair and deceptive business practice. TI is not responsible or liable for any such statements.

Following are URLs where you can obtain information on other Texas Instruments products and application solutions:

Products		Applications	
Amplifiers	amplifier.ti.com	Audio	www.ti.com/audio
Data Converters	dataconverter.ti.com	Automotive	www.ti.com/automotive
DSP	dsp.ti.com	Broadband	www.ti.com/broadband
Interface	interface.ti.com	Digital Control	www.ti.com/digitalcontrol
Logic	logic.ti.com	Military	www.ti.com/military
Power Mgmt	power.ti.com	Optical Networking	www.ti.com/opticalnetwork
Microcontrollers	microcontroller.ti.com	Security	www.ti.com/security
		Telephony	www.ti.com/telephony
		Video & Imaging	www.ti.com/video
		Wireless	www.ti.com/wireless

Mailing Address: Texas Instruments
Post Office Box 655303 Dallas, Texas 75265